

**TOSHIBA**

FILE NO. 020-200116

SERVICE MANUAL

**COLOR TELEVISION**

N1PS Chassis

***36HFX71, 32HFX71***

*(TAC0130)*

*(TAC0132)*

# TABLE OF CONTENTS

## CHAPTER 1 GENERAL ADJUSTMENTS

SAFETY INSTRUCTIONS .....	3
SET-UP ADJUSTMENT .....	4
SERVICE MODE .....	8
ELECTRICAL ADJUSTMENTS .....	11
CIRCUIT CHECKS .....	13

## CHAPTER 2 SPECIFIC INFORMATIONS

SETTING & ADJUSTING DATA .....	14
LOCATION OF CONTROLS .....	15
PROGRAMMING CHANNEL MEMORY .....	17
CIRCUIT BLOCK DIAGRAM .....	18
CHASSIS AND CABINET REPLACEMENT PARTS LIST .....	19
PC BOARDS BOTTOM VIEW .....	43
TERMINAL VIEW OF TRANSISTORS .....	53
SPECIFICATIONS .....	55

### APPENDIX:

CIRCUIT DIAGRAM

## SAFETY INSTRUCTIONS

**WARNING:** BEFORE SERVICING THIS CHASSIS, READ THE “X-RAY RADIATION PRECAUTION”, “SAFETY PRECAUTION” AND “PRODUCT SAFETY NOTICE” INSTRUCTIONS BELOW.

### X-RAY RADIATION PRECAUTION

- Excessive high voltage can produce potentially hazardous X-RAY RADIATION. To avoid such hazards, the high voltage must not be above the specified limit. The nominal value of the high voltage of this receiver is (A) kV at zero beam current (minimum brightness) under a 120V AC power source. The high voltage must not, under any circumstances, exceed (B) kV.
- This receiver is equipped with a Fail Safe (FS) circuit which prevents the receiver from producing an excessively high voltage even if the B+ voltage increases abnormally. Each time the receiver is serviced, the FS circuit must be checked to determine that the circuit is properly functioning, following the FS CIRCUIT CHECK procedure in this manual.
- The only source of X-RAY RADIATION in this TV receiver is the picture tube. For continued X-RAY RADIATION protection, the replacement tube must be exactly the same type tube as specified in the parts list.
- Some part in this receiver have special safety-related characteristics for X-RAY RADIATION protection. For continued safety, parts replacement should be undertaken only after referring to the PRODUCT SAFETY NOTICE below.

Refer to table-1 for high voltage (A), (B).  
(See SETTING & ADJUSTING DATA on page 14)

Each time a receiver requires servicing, the high voltage should be checked following the HIGH VOLTAGE CHECK procedure in this manual. It is recommended that the reading of the high voltage be recorded as a part of the service record. It is important to use an accurate and reliable high voltage meter.

### SAFETY PRECAUTION

**WARNING :** Service should not be attempted by anyone unfamiliar with the necessary precautions on this receiver. The following are the necessary precautions to be observed before servicing this chassis.

- An isolation Transformer should be connected in the power line between the receiver and the AC line before any service is performed on the receiver.
- Always discharge the picture tube anode to the CRT conductive coating before handling the picture tube. The picture tube is highly evacuated and if broken, glass fragments will be violently expelled. Use shatter proof goggles and keep picture tube away from the unprotected body while handling.
- When replacing a chassis in the cabinet, always be certain that all the protective devices are put back in place, such as; non-metallic control knobs, insulating covers, shields, isolation resistor-capacitor network etc.
- Before returning the set to the customer, always perform an AC leakage current check on the exposed metallic parts of the cabinet, such as antennas, terminals, screwheads, metal overlays, control shafts etc. to be sure the set is safe to operate without danger of electrical shock. Plug the AC line cord directly into a 120V AC outlet (do not use a line isolation transformer during this check). Use an AC voltmeter having 5000 ohms per volt or more sensitivity in the following manner:

Connect a 1500 ohm 10 watt resistor, paralleled by a 0.15  $\mu$ F, AC type capacitor, between a known good earth ground (water pipe, conduit, etc.) and the exposed metallic parts, one at a time. Measure the AC voltage across the combination of 1500 ohm resistor and 0.15  $\mu$ F capacitor. Reverse the AC plug at the AC outlet and repeat AC voltage measurements for each exposed metallic part. Voltage measured must not exceed 0.3 volts rms. This corresponds to 0.2 milliamp. AC. Any value exceeding this limit constitutes a potential shock hazard and must be corrected immediately.

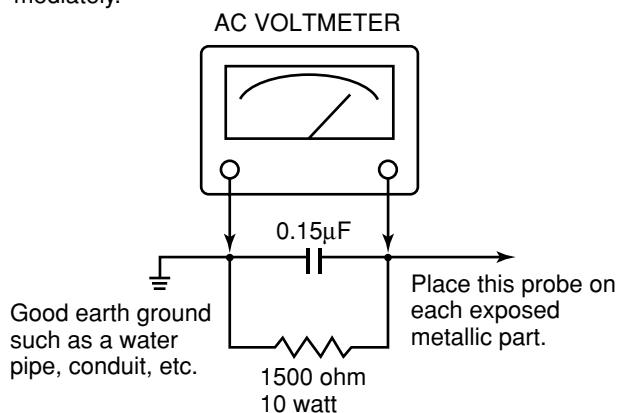

### PRODUCT SAFETY NOTICE

Many electrical and mechanical parts in this chassis have special safety-related characteristics. These characteristics are often passed unnoticed by a visual inspection and the protection afforded by them cannot necessarily be obtained by using replacement components rated for higher voltage, wattage, etc. Replacement parts which have these special safety characteristics are identified in this manual and its supplements; electrical components having such features are identified by the international hazard symbols on the schematic diagram and the parts list.

Before replacing any of these components, read the parts list in this manual carefully. The use of substitute replacement parts which do not have the same safety characteristics as specified in the parts list may create shock, fire, X-ray radiation or other hazards.

**WARNING:** BEFORE SERVICING THIS CHASSIS, READ THE "X-RAY RADIATION PRECAUTION", "SAFETY PRECAUTION" AND "PRODUCT SAFETY NOTICE" ON PAGE 3 OF THIS MANUAL.

## SET-UP ADJUSTMENT

- The following adjustments should be made when a complete realignment is required or a new picture tube is installed. Perform the adjustments in order as follows :

1. Color Purity
2. Convergence
3. White Balance

Note: 1. The PURITY/CONVERGENCE MAGNET assembly and rubber wedges need mechanical positioning. Refer to figure 1.

2. Mounting position of the purity magnet assembly should fit to same position as old one because slightly difference to the position depend on a kind of tube.

- \* There are no adjustment of purity and convergence in some picture tube (Unified with purity magnet)

### COLOR PURITY ADJUSTMENT

NOTE : Before attempting any purity adjustments, the receiver should be operated for at least fifteen minutes.

1. Evenly degauss the entire screen.
2. Set the CONTRAST and BRIGHTNESS Controls to the maximum.
3. Display built-in green raster using the TEST SIGNAL SELECTION function.
4. Loosen the clamp screw holding the deflection yoke (and remove the rubber Wedges).
5. Slide the yoke forward or backward to provide vertical green belt (zone) in the picture screen.
6. Rotate and spread the tabs of the purity magnet (See figure 4.) around the neck of the picture tube until the green belt is in the center of the screen. At the same time, center the raster vertically by adjusting the magnet as shown below.

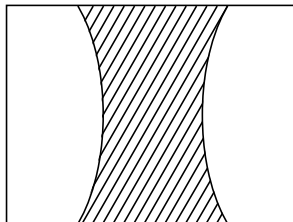

Green Belt

7. Move the yoke slowly forward or backward until a uniform green screen is obtained. Tighten the clamp screw of the yoke temporarily.
8. Check the purity of the red and blue raster.
9. Put four wedges into the space between the picture tube and the yoke to hold the yoke in the adjusted position. (See figure 2.) Do not tilt the yoke by excessive insertion of the wedge.
10. Remove cover paper of wedge and stick wedges on the tube to fix the yoke in the adjusted position. Fix the wedges with glass cloth tapes.

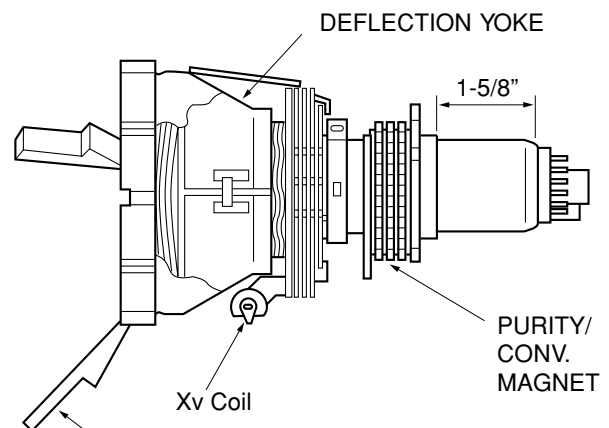

Figure 1.

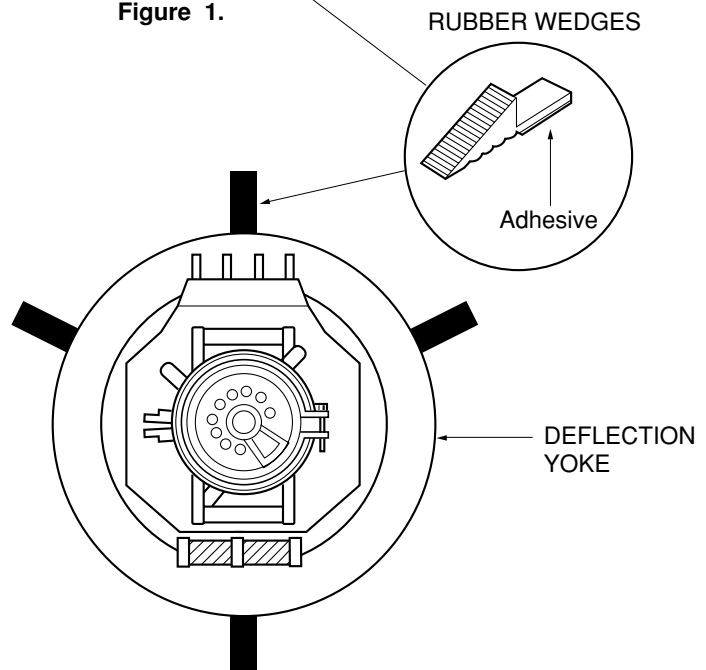

Figure 2.

**CONVERGENCE ADJUSTMENTS**

NOTE: Before attempting any convergence adjustments, the receiver should be operated for at least fifteen minutes.

■ **CENTER CONVERGENCE ADJUSTMENT**

1. Display built-in cross-dot pattern using the TEST SIGNAL SELECTION function.
2. Adjust the BRIGHTNESS and CONTRAST Controls for well defined pattern.
3. Loosen the tightening ring and adjust two tabs of the 4-Pole Magnets to change the angle between them (See figure 4.) and superimpose red and blue vertical lines in the center area of the picture screen. (See figure 3.)
4. Turn the both tabs at the same time keeping the constant angle to superimpose red and blue horizontal lines at the centre of the screen. (See figure 3.)
5. Adjust two tabs of 6-Pole Magnets to superimpose red/blue line with green one. Adjusting the angle affects the vertical lines and rotating both magnets affects the horizontal lines.
6. Repeat adjustments 3, 4, 5 keeping in mind red, green and blue movement, because 4-Pole Magnets and 6-Pole magnets interact and make dot movement complex.
7. After completing the "CENTER CONVERGENCE ADJUSTMENT" tighten the tightening ring to fix the magnets.

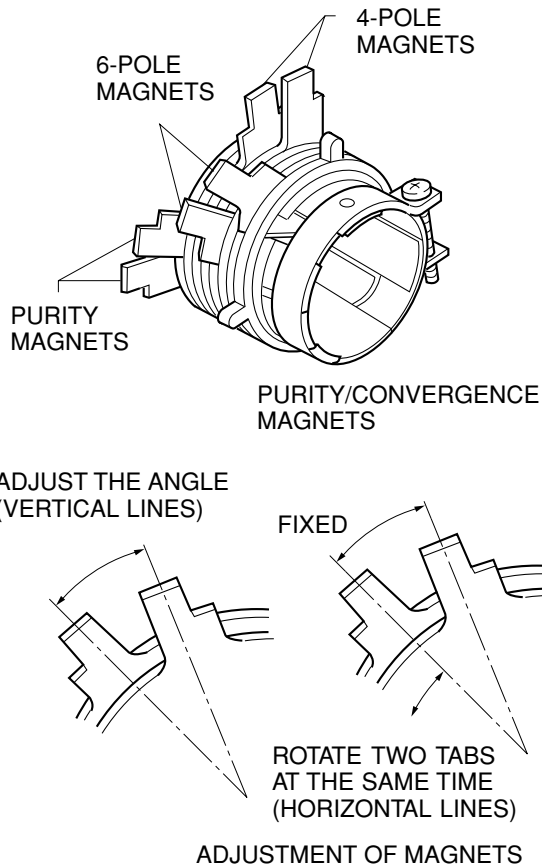
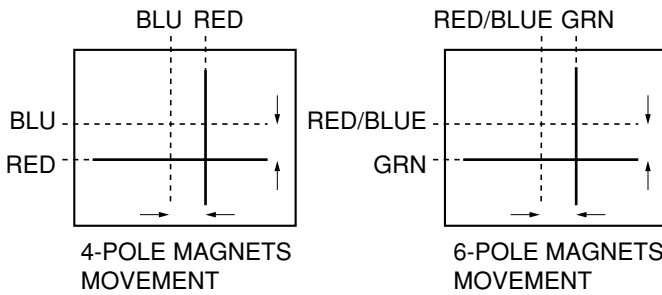

Figure 4.



Center Convergence by Convergence Magnets

Figure 3.

■ **Xv COIL ADJUSTMENT**

Adjust the Xv coil (on the deflection yoke) to correct misconvergence at both sides on screen. Use a hexagonal tip stick (plastic) to adjust the core of coil.

**Clockwise Adjustment    Counterclockwise Adjustment**

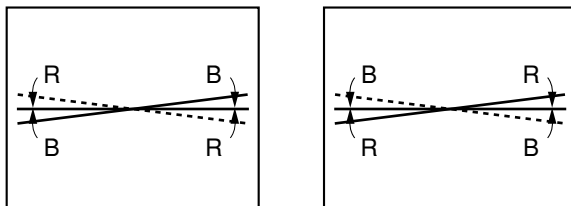

Xv Cross Pattern View

■ **SCREEN-CORNER CONVERGENCE**

When the misconvergence is still evident on corners even though the above adjustment is done, use the ferrite sheet (Part No. 23993622) to correct misconvergence.

1. Put ferrite sheets into the space under the yoke. Decide such position that misconvergence becomes minimum, watching picture screen. (See figure below.)
2. Remove cover paper of ferrite sheet to stick it in the place on the tube. Put adhesive tapes on ferrite sheets to fix.

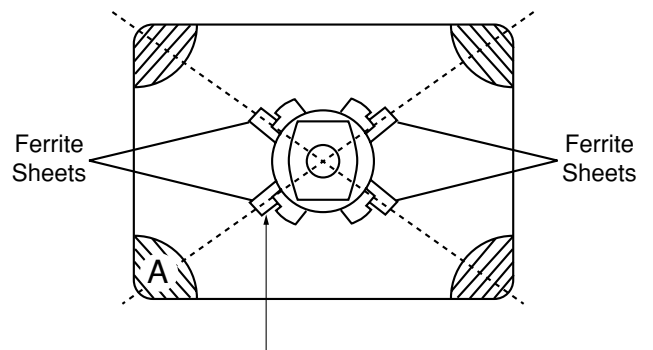

For correcting misconvergence on the position A

**WARNING:** BEFORE SERVICING THIS CHASSIS, READ THE "X-RAY RADIATION PRECAUTION", "SAFETY PRECAUTION" AND "PRODUCT SAFETY NOTICE" ON PAGE 3 OF SERVICE MANUAL.

## (SET-UP ADJUSTMENT FOR FLAT TUBE)

■ The following adjustments should be made when a complete realignment is required or a new picture tube is installed. Perform the adjustments in order as follows :

1. Color Purity
2. Convergence
3. White Balance

**Note:** The PURITY/CONVERGENCE MAGNET assembly and rubber wedges need mechanical positioning. Refer to figure 1.

### COLOR PURITY ADJUSTMENT

- (1) Let the screen face in the installing direction or toward the east (when it is to be moved), bring up the service mode screen after demagnetizing (front, left, right, and top) with the degaussing coil, receive white signals by pressing the [TV/VIDEO] button, and then the receiver should be operated for more than 40 minutes.
- (2) Perform rough adjustment of the central convergence with the P/C magnet according to the adjustment item.
- (3) Receive built-in green signals, loosen set screws on the deflection yoke, remove rubber wedges, and shift the deflection yoke toward front.
- (4) Move alternately the two 2-pole magnets of the P/C magnets so that the green raster can come to the center of the screen.

Figure 1.

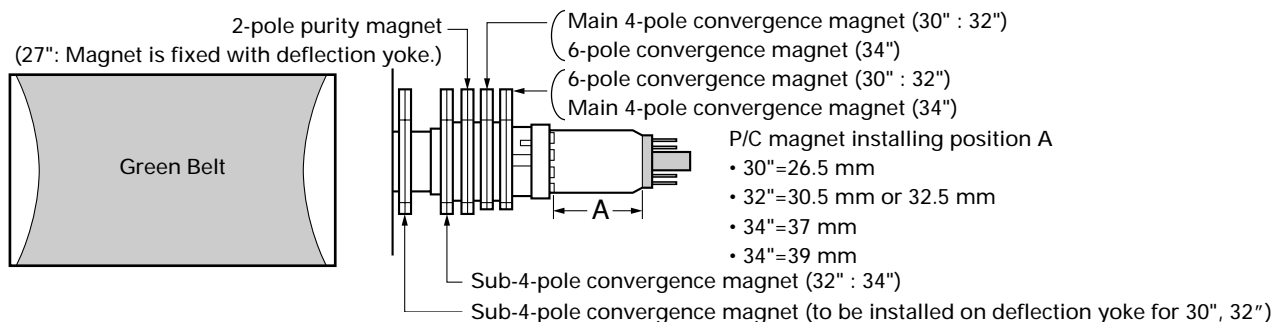

- (5) Receive built-in red and blue signals, check that there is no inclination of the single color raster toward one side, and if each color tilts to a great extent, make adjustment with the 2-pole magnet so that the 3 colors will come to the center evenly.
- (6) Receive the green raster, shift the deflection yoke from a foremost position (hitting against the picture tube) to a backward position horizontally, stop the deflection yoke at a position where it begins to become a green raster, and perform accurate marking on the picture tube.
- (7) Shift the deflection yoke further backward, and perform accurate marking at a position where the green raster begins to be luck.
- (8) Fix the deflection yoke at a position 60% forward within the range marked in items (6) and (7) above.

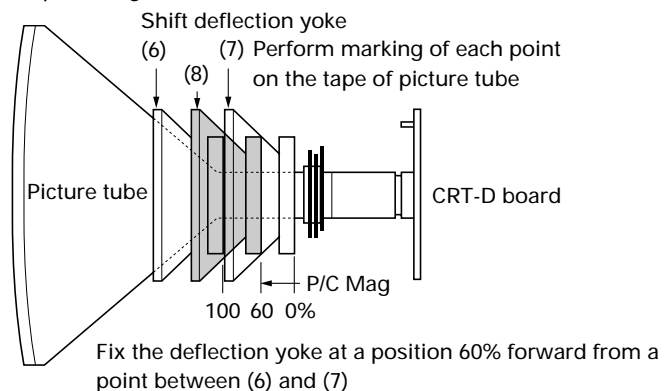

### CONVERGENCE ADJUSTMENTS

\* Adjust the convergence magnet to get vest convergence in the the order to (1) ~ (5).

#### ■ CENTER CONVERGENCE:

- (1) Receive the white crosshatch or dot pattern from the service signal generator.
- (2) Use the 2 pieces of main 4-pole magnets of P/C magnets, change the open angle, and align the red and blue vertical lines on the screen center.
- (3) Freeze the open angle of the main 4-pole magnets, turn them simultaneously, and align the horizontal lines.
- (4) Take the same steps for items (2) and (3) above and align red/blue with green on the screen center using two 6-pole magnets.

(5) Adjust the sub-4-pole magnets only in case there is any deviation of Xv bow-shaped convergence. (To be usually set at the initial position)  
Align both sides with the sub-4-pole magnets and minimize the deviation of blue and red with the main 4-pole magnets.

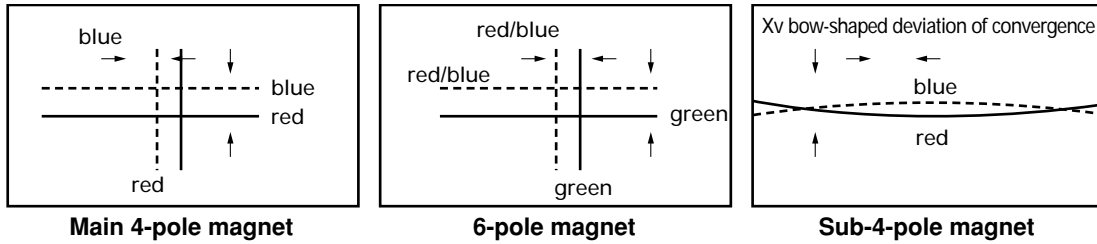

**■ CIRCUMFERENCE CONVERGENCE:**

\* Perform correction in the following manner.

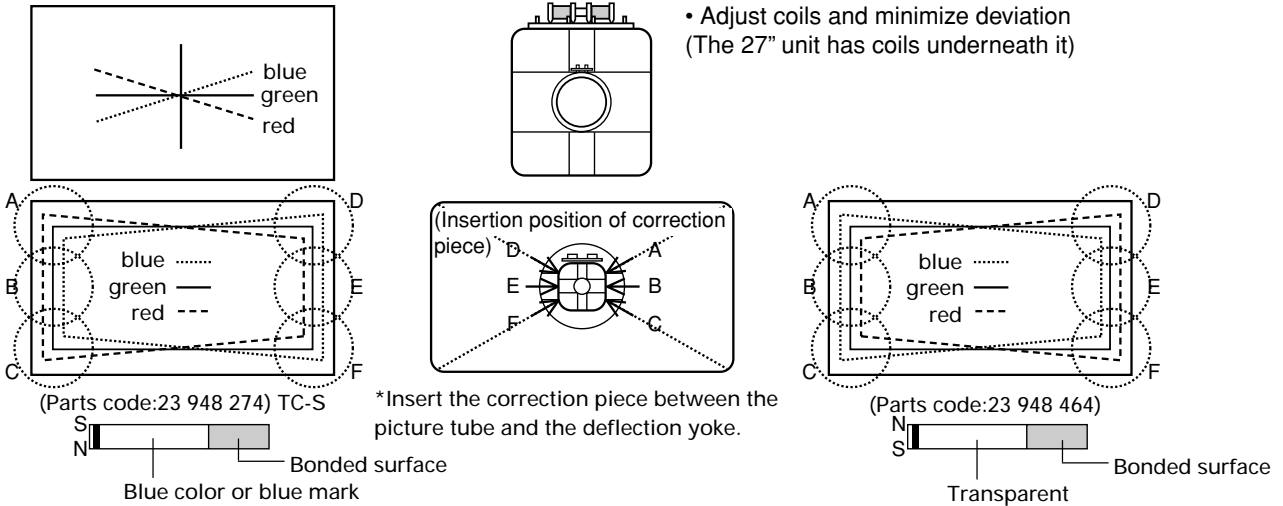

• Adjust coils and minimize deviation (The 27" unit has coils underneath it)

**Adjust VR 1 and minimize the deviation of YH. \*Only 27", 30" and 32".**

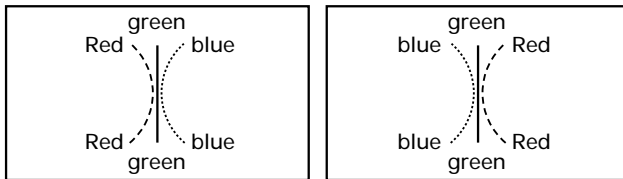

**Adjust VR 2 (YHC) and minimize the deviation of YH.**

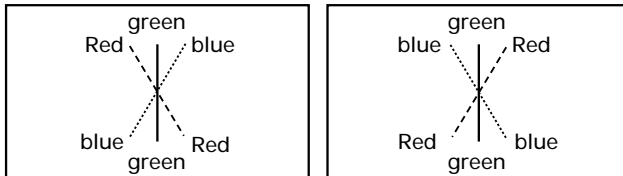

**Adjust VR 3 (YV) and minimize the deviation of YV.**

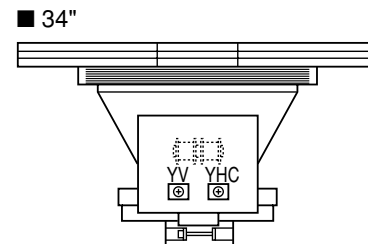
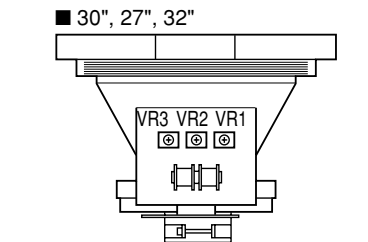
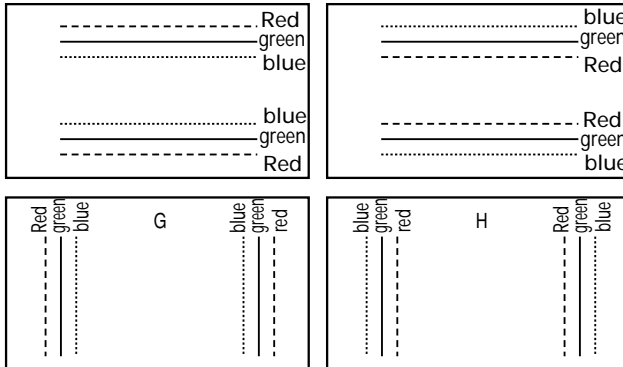

27" (Part No. 23 947 371)  
32", 30" (Part No. 23 947 121)  
34" (Part No. 23 993 080)

Perform correction by inserting the correction piece into the clearance of terminal board coils of the deflection yoke.

**Note:**  
Perform insertion by turning the metal side to the terminal board side of the deflection yoke.

# SERVICE MODE

## 1. ENTERING TO SERVICE MODE

1) Press MUTE button twice on Remote Control.

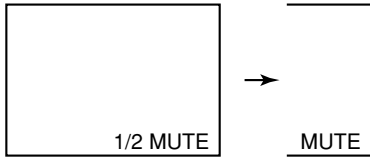

2) Press MUTE button again to keep pressing.



3) While pressing the MUTE button, press MENU button on TV set.



(Service mode display)

## 2. DISPLAYING THE ADJUSTMENT MENU

1) Press MENU button on TV.

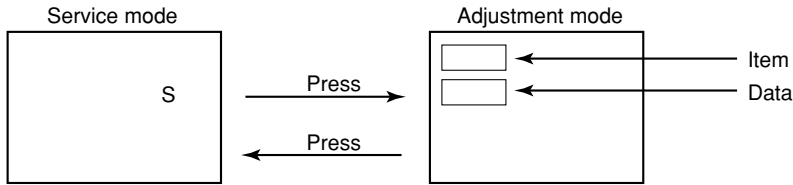

## 3. KEY FUNCTION IN THE SERVICE MODE

The following key entry during display of adjustment menu provides special functions.

- |   |                                   |
|---|-----------------------------------|
| A single horizontal line ON/OFF:            | TV (ANT)/VIDEO button (on TV)     |
| Test signal selection :                     | TV (ANT)/VIDEO button (on Remote) |
| Selection of the adjustment items :         | Channel ▲/▼ (on TV or Remote)     |
| Change of the data value :                  | Volume ▲/▼ (on TV or Remote)      |
| Adjustment menu mode ON/OFF :               | MENU button (on TV)               |
| Initialization of the memory (QA02, QA04) : | RECALL+Channel (▲) button on TV   |
| Initialization of the self diagnostic data: | RECALL+Channel (▼) button on TV   |

- |                                   |          |
|-----------------------------------|----------|
| “RCUT” selection :                | 1 button |
| “GCUT” selection :                | 2 button |
| “BCUT” selection :                | 3 button |
| “CNTX” selection :                | 4 button |
| “COLC” selection :                | 5 button |
| “TNTC” selection :                | 6 button |
| Test audio signal ON/OFF (1kHz) : | 8 button |
| Self diagnostic display ON/OFF :  | 9 button |



#### 4. SELECTING THE ADJUSTING ITEMS

- 1) Every pressing of CHANNEL ▲ button in the service mode changes the adjustment items in the order of table-2. (▼ button for reverse order)

Refer to table-2 for preset data of adjustment mode.  
(See SETTING & ADJUSTING DATA on page 14)

#### 5. ADJUSTING THE DATA

- 1) Pressing of VOLUME ▲ or ▼ button will change the value of data in the range from 00H to FFH. The variable range depends on the adjusting item.

#### 6. EXIT FROM SERVICE MODE

- 1) Pressing POWER button to turn off the TV once.

#### ■ INITIALIZATION OF MEMORY DATA OF QA02 AND QA04

After replacing QA02 and QA04, the following initialization is required.

1. Enter the service mode, then select any register item.
2. Press and hold the RECALL button on the Remote, then press the CHANNEL ▲ button on the TV. The initialization of QA02 and QA04 has been completed.
3. Check the picture carefully. If necessary, adjust any adjustment item above.  
Perform "Programming Channel Memory" on the owner's manual.

CAUTION: Never attempt to initialize the data unless QA02, QA04 has been replaced.

#### 7. TEST SIGNAL SELECTION

- 1) Every pressing of TV/VIDEO button on the Remote Control in the Service mode changes the built-in test patterns on screen in the following order.

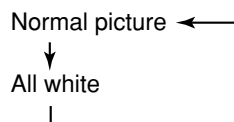

Signals	Picture
• All White	

- 2) Press "8" button while any built-in test pattern to on the screen to output the 1 kHz sound. Press the button again to cut off the sound.

Note: If the video cable is connected to the VIDEO1 INPUT jack, the built-in pattern signals are not displayed.

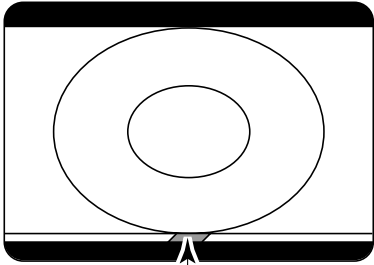
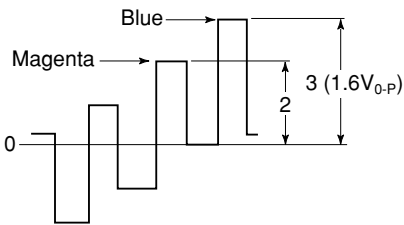

## ELECTRICAL ADJUSTMENTS

ITEM	ADJUSTMENT PROCEDURE
FOCUS VR ADJ	<ol style="list-style-type: none"> <li>1. Enter the service mode, then select any register item.</li> <li>2. Press the TV/VIDEO button on the Remote until the black cross-bar pattern appears on the screen.</li> <li>3. Adjust the FOCUS control (on T461) for well defined scanning lines on the picture screen.</li> </ol>
SUB-BRIGHTNESS (BRTC)	<ol style="list-style-type: none"> <li>1. Constrict the picture height until the vertical retrace line appears adjusting the item HIT (HEIGHT).</li> <li>2. Adjust the CONTRAST control to the minimum.</li> <li>3. Call up the adjustment mode display, then select the item <b>BRTC</b>.</li> <li>4. Press the VOLUME ▲ or ▼ button so the belt of vertical retrace line just disappear.</li> <li>5. Adjust the CONTRAST control for the desired contrast.</li> <li>6. Perform the HEIGHT adjustment.</li> </ol> <div style="text-align: center;">  <p style="text-align: center;">Vertical retrace line</p> </div>
SUB-COLOR (SCOL) SUB-TINT (TNTC)	<ol style="list-style-type: none"> <li>1. Receive color-bar signal from color-bar generator.</li> <li>2. Press the RESET button.</li> <li>3. Connect oscilloscope to TP501 on SIGNAL board.</li> <li>4. Adjust the CONTRAST control to the minimum.</li> <li>5. Call up the adjustment mode display, then select the item <b>TNTC</b>.</li> <li>6. Adjust the SUB-TINT by pressing the VOLUME ▲ or ▼ button to obtain a blue bar to magenta bar ratio of 3:2 as shown.</li> <li>7. Press the RESET button.</li> <li>8. Select the item <b>SCOL</b>.</li> <li>9. Adjust the SUB-COLOR by pressing the VOLUME ▲ or ▼ button to achieve 1.6V<sub>0-P</sub> of a blue bar on scope.</li> <li>10. Check the picture with off-air signal.</li> </ol> <div style="text-align: center;">  </div>
WIDTH (WID)	<ol style="list-style-type: none"> <li>1. Call up the adjustment mode display, then select the item <b>WID</b>.</li> <li>2. Press the VOLUME ▲ or ▼ button to get the picture so the left and right edges of raster begins to lack.</li> <li>3. Press the VOLUME ▲ or ▼ button to advance the data by 7 steps.</li> </ol> <p>Note : Check the horizontal picture position is correct.</p>

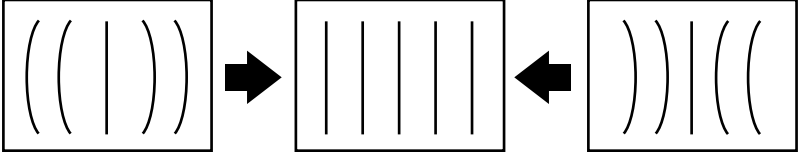
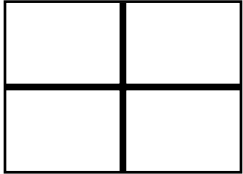
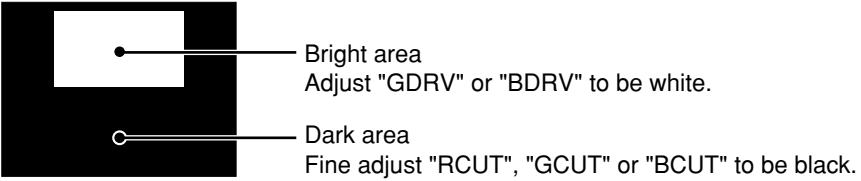
ITEM	ADJUSTMENT PROCEDURE
<p>E-W PARABOLA (DPC) (PARA)</p>	<ol style="list-style-type: none"> <li>1. Call up the adjustment mode display, then select the item <b>PARA</b>.</li> <li>2. Press the TV/VIDEO button on Remote until the cross-hatch pattern appears on the screen.</li> <li>3. Press the VOLUME ▲ or ▼ button to make vertical lines straight as shown below.</li> </ol> 
<p>HORIZONTAL POSITION (HPOS) VERTICAL POSITION (VPOS)</p>	<ol style="list-style-type: none"> <li>1. Call up the adjustment mode display, then select the item <b>HPOS</b> or <b>VPOS</b>.</li> <li>2. Press the TV/VIDEO button on Remote until the white cross-bar or black cross-bar pattern appears on the screen.</li> <li>3. Adjust the HORIZONTAL and VERTICAL position alternately by pressing the VOLUME ▲ or ▼ button for proper picture position.</li> <li>4. Check the picture with off-air signal.</li> </ol> 
<p>HEIGHT (HIT)</p>	<ol style="list-style-type: none"> <li>1. Call up the adjustment mode display, then select the item <b>HIT</b>.</li> <li>2. Press the VOLUME ▲ or ▼ button to get the picture so the top of raster begins to lack.</li> <li>3. Press the VOLUME ▲ button to advance the data by 9 steps.</li> </ol> <p>Note : Check the vertical picture position is correct.</p>
<p>WHITE BALANCE (RCUT) (GCUT) (BCUT) (GDRV) (BDRV)</p>	<ol style="list-style-type: none"> <li>1. Adjust the CONTRAST control to the center, and BRIGHTNESS control to the maximum.</li> <li>2. Call up the adjustment mode display, and press the TV/VIDEO button on Remote until the white and black pattern appears on the screen.</li> <li>3. Adjust the following items with the CHANNEL ▲/▼ and VOLUME ▲/▼ buttons. <ul style="list-style-type: none"> <li>Item : RCUT → Data : 40H</li> <li>Item : GCUT → Data : 40H</li> <li>Item : BCUT → Data : 40H</li> <li>Item : GDRV → Data : 40H</li> <li>Item : BDRV → Data : 40H</li> </ul> </li> <li>4. Press the TV/VIDEO button on TV to display a single horizontal line on the screen.</li> <li>5. Turn the SCREEN control (FBT) fully counterclockwise and gradually rotate clockwise until the first horizontal line appears slightly on the screen.</li> <li>6. Press the TV/VIDEO button to display the normal picture.</li> <li>7. Adjust the remaining two “?CUT” items (CHANNEL ▲/▼ → TV/VIDEO → VOLUME ▲/▼ in order) to obtain the slightly lighted horizontal line in the same levels of three (red, green, blue) colors. The line should be white if the adjustments are proper.</li> </ol> 

# CIRCUIT CHECKS

## HIGH VOLTAGE CHECK

**CAUTION:** There is no HIGH VOLTAGE ADJUSTMENT on this chassis. Checking should be done following the steps below.

1. Connect an accurate high voltage meter to the second anode of the picture tube.
2. Turn on the receiver. Set the BRIGHTNESS and CONTRAST controls to minimum (zero beam current).
3. High voltage must be measured below (B) kV.

Refer to table-1 for high voltage (B).  
(See SETTING & ADJUSTING DATA on page 14)

4. Vary the BRIGHTNESS control to both extremes to be sure the high voltage does not exceed the limit under any conditions.

## FS CIRCUIT CHECK

The Fail Safe (FS) circuit check is indispensable for the final check in servicing. Checking should be done following the steps below.

1. Turn the receiver on and press the RESET button.
2. Temporarily short TP-(R) and TP-(X) with a jumper wire. Raster and sound will disappear.
3. The receiver must remain in this state even after removing the jumper wire. This is the evidence that the FS circuit is functioning properly.
4. To obtain a picture again, temporarily turn the receiver off and allow the FS circuit more than 5 seconds to reset. Then turn the power switch on to produce a normal picture.

## Troubleshooting Guide for Fail Safe Circuit

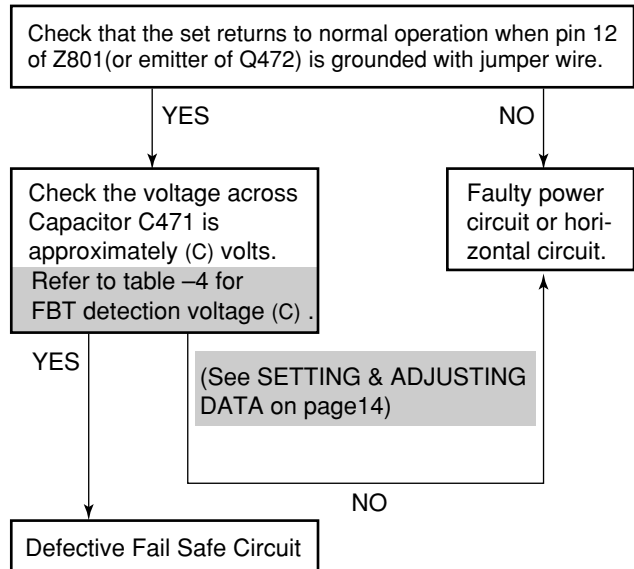

## CHAPTER 2 SPECIFIC INFORMATIONS

### SETTING & ADJUSTING DATA

#### 【 SAFETY INSTRUCTIONS 】

		36"	32"
HIGH VOLTAGE AT ZERO BEAM:	(A)	32.7 kV	32.7 kV
MAX HIGH VOLTAGE:	(B)	34.1 kV	34.1 kV

Table-1

#### 【 SERVICE MODE 】

#### ADJUSTING ITEMS AND DATAS IN THE SERVICE MODE:

Item	Name of adjustment	Preset	Data	Item	Name of adjustment	Preset	Data
RCUT	R CUTOFF	40H	←	CNR	E-W CORNER	13H	←
GCUT	G CUTOFF	40H	←	TRAP	TRAPEZIUM	33H	←
BCUT	B CUTOFF	40H	←	HCP	H-COMPENSATION	02H	←
GDRV	G DRIVE	40H	←	VFC	V-F CORRECTION	0CH	←
BDRV	B DRIVE	40H	←	HPS	H-POSITION	3FH	←
BRTC	BRIGHT CENT	80H	←	BLKS	BLANKING START	—	←
TNTC	TINT CENT	44H	←	BLKE	BLANKING END	—	←
SCOL	SUB-COLOR	06H	←	GMPS	GMPS	2CH	←
SCNT	SUB-CONTRAST	12H	←	CPAR	CENTER PARA	04H	←
HIT	HEIGHT	40H	←	PHUE	PIP TINT	40H	←
LIN	V-LINEARITY	14H	←	PCNT	PIP CONTRAST	10H	←
VSC	V-S CORRECTION	36H	←	PCOL	PIP COLOR	15H	←
VPS2	V-SHIFT	02H	←	OPT1		4AH	←
VCP	V-COMPENSATION	02H	←	OPT2		25H	←
WID	PICTURE WIDTH	31H	←	TVOP		18H	←
PARA	E-W PARABOLA	16H	←				

Table-2

#### OPTION: (PROGRESSIVE 4:3 DV)

MODELS	OPT1 (2CAH)	OPT2(2CBH)
	HEX	HEX
36HFX71	4AH	25H
32HFX71	4AH	25H

Table-3

#### 【 CIRCUIT CHECKS 】

FBT DETECTION VOLTAGE	(C)	18.9 V
-----------------------	-----	--------

Table-4

# LOCATION OF CONTROLS

## TV Front

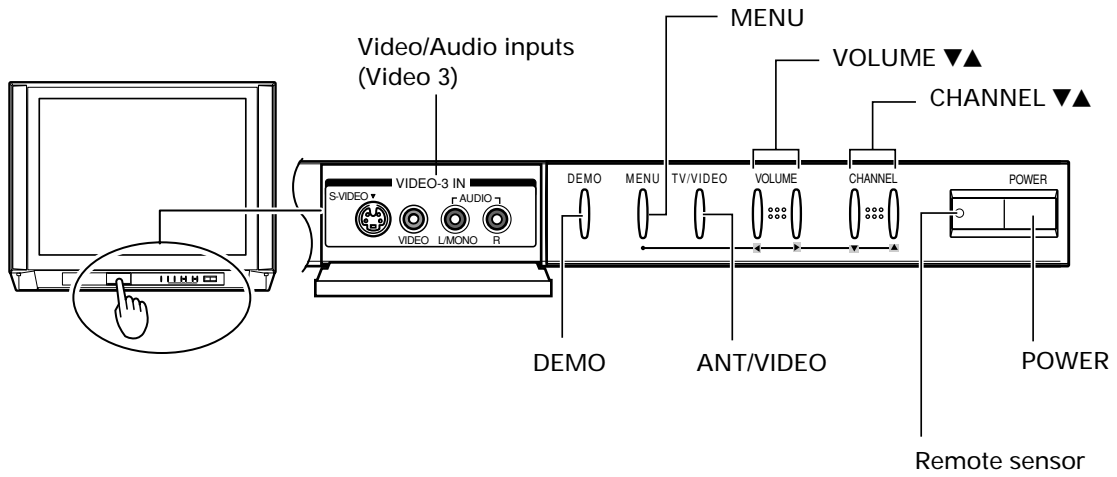

## TV Rear

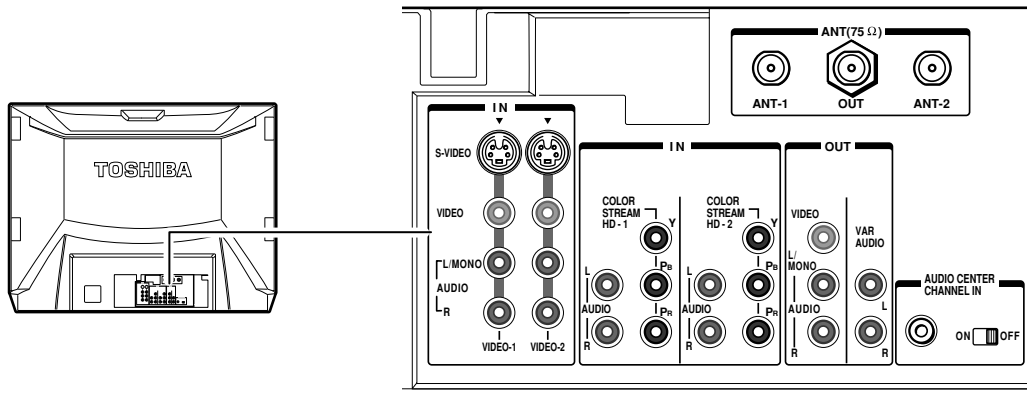

## Remote Control

**Power** turns the TV on or off

**SLEEP** sets the TV to turn at a specific time

**LIGHT** The initial press of the LIGHT button causes two actions:

**Channel Numbers (0–9, 100)** allow direct access to channels

**MODE** cycles through the 6 device modes

**FAVOURITE** allows access to Multi-Window function

**INFO** allows access to Multi-Window function

**MENU** allows access to programming

**ENTER** sets programming menu information

**▲▼◀▶** selects or adjusts programming menus

**[FAV] ◀▶** selects your favourite channels

**Volume ▲▼** adjusts the volume level

**EXIT** exits programming menus

**Channel ▲▼** cycles through programmed channels

**CH RTN** returns to the last viewed channels

**RECALL** displays on-screen information

**MUTE** mutes the sound

**INPUT** selects video input source

**PIP** allows access to PIP functions

**PIP** turns the PIP on or off

**PIP CH ▲▼** selects the PIP channels

**MULTI** allows access to Multi-Windows function

**STILL** freezes the PIP

**SOURCE** selects the PIP source

**LOCATE** moves the PIP

**SWAP** switches the PIP and main pictures

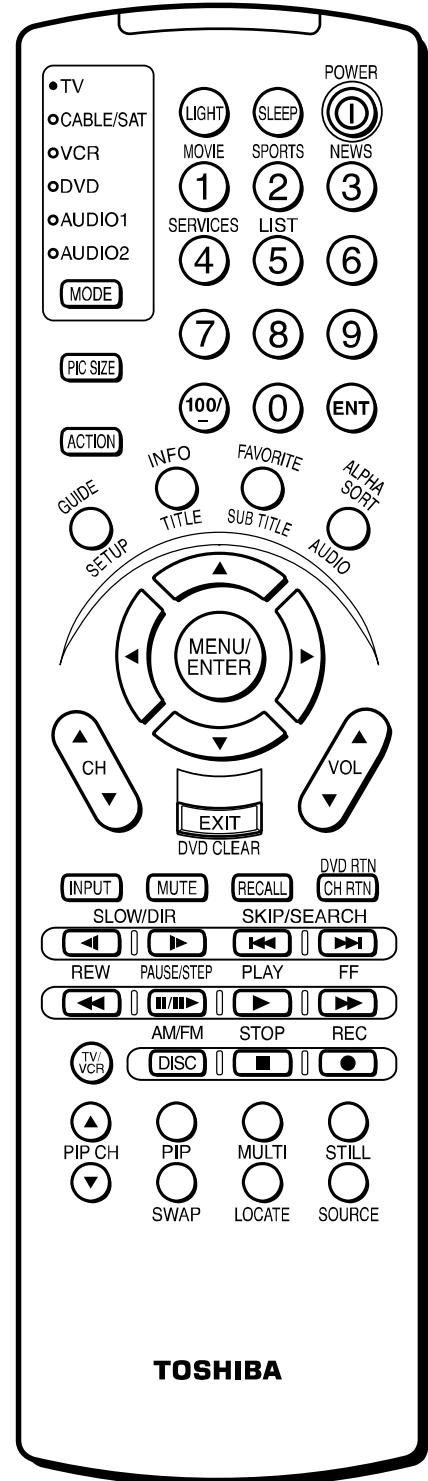



## PROGRAMMING CHANNEL MEMORY

The channel memory is the list of TV channel numbers your TV will stop on when you press the CHANNEL ▲ or ▼ button.

**First, use the TV/CABLE and CH PROGRAM functions to preset all active channels in your area automatically.**

If necessary, arrange the preset channels with the ADD/ERASE functions so that you can tune into only desired channels.

**Note:** If you utilize both ANT-1 and ANT-2 terminals for some model, perform programming channels for each input source.

### TV/CABLE function

- 1 Press **MENU**, then press ► or ◀ until the SET UP menu appears.
- 2 Press ▼ (or ▲) until "TV/CABLE" is highlighted.
- 3 Press ► or ◀ to highlight either "TV" or "CABLE", whichever you use.

### CH PROGRAM function

- 1 Select "CH PROGRAM" following steps 1 and 2 above.
- 2 Press ► or ◀ to start channel programming.  
The TV will automatically cycle through all the TV or CABLE channels selected by the TV/CABLE function, and store active channels in the channel memory.
- 3 When channel programming is complete, you will see the message to the right.
- 4 Press **CHANNEL ▲** or **▼** to make sure the channel programming has been done properly.

### ADD/ERASE function

After performing the CH PROGRAM function, you can add or erase specific channels.

- 1 Select the channel you want to erase using the CHANNEL ▲ or ▼ button, or select the channel you want to add using the **Channel Number** buttons.
- 2 Press **MENU**, then press ► or ◀ until the SET UP menu appears.
- 3 Press ▼ (or ▲) until "ADD/ERASE" is highlighted.
- 4 Press ► or ◀ :  
**To erase the channel**  
Press the button until "Erase" is highlighted.  
**To add the channel**  
Press the button until "Add" is highlighted.
- 5 Repeat steps 1 to 4 for other channels.

You have now completed the channel programming.

**Note:** The CHANNEL ▼/▲ buttons on the TV function as the ▼/▲ buttons while a menu is on the screen.

\* Please refer to owner's manual in detail.

# CIRCUIT BLOCK DIAGRAM

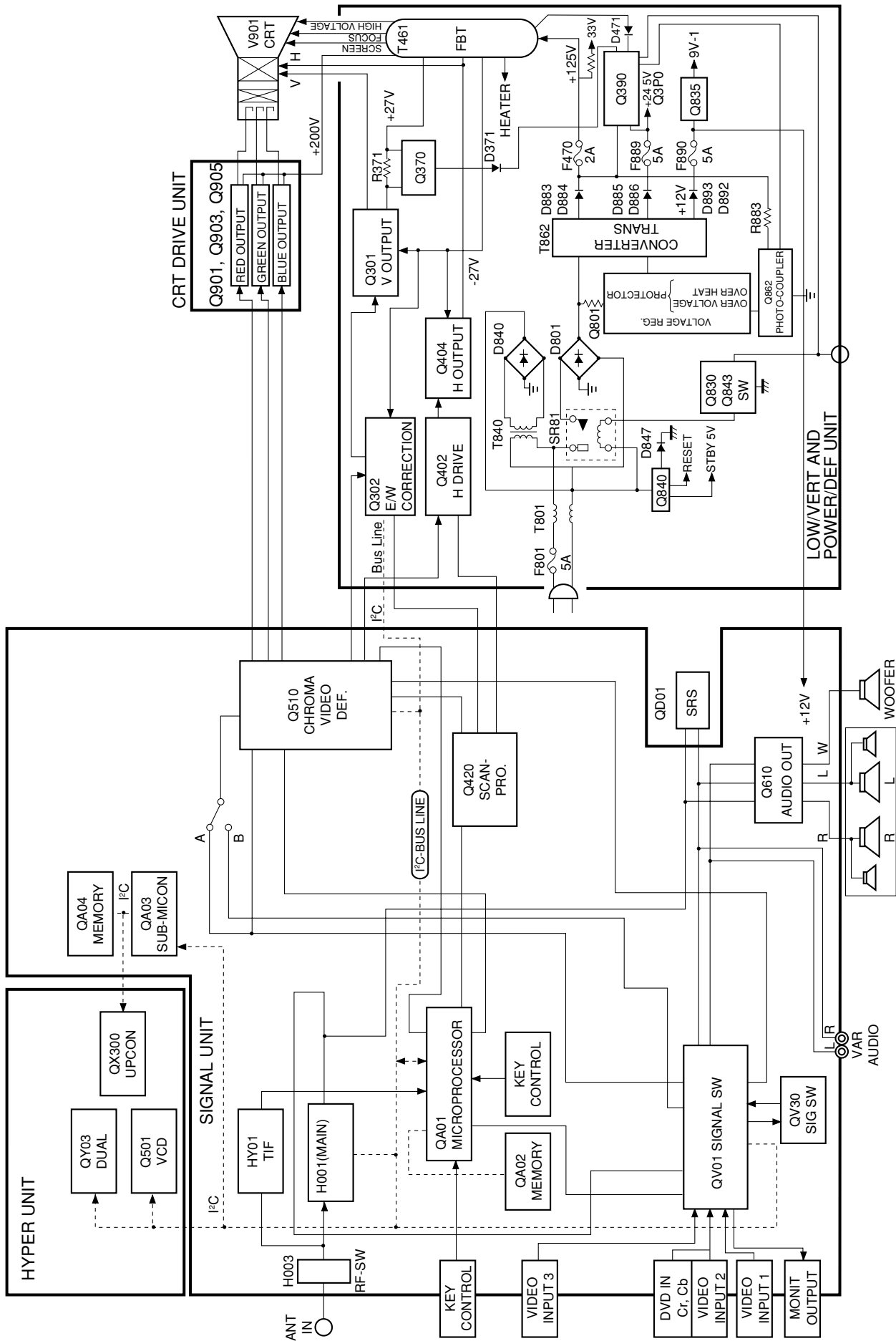

# CHASSIS AND CABINET REPLACEMENT PARTS LIST

**WARNING:** BEFORE SERVICING THIS CHASSIS, READ THE "X-RAY RADIATION PRECAUTION", "SAFETY PRECAUTION" AND "PRODUCT SAFETY NOTICE" ON PAGE 3 OF THIS MANUAL.

**CAUTION:** The international hazard symbols "⚠" in the schematic diagram and the parts list designate components which have special characteristics important for safety and should be replaced only with types identical to those in the original circuit or specified in the parts list. The mounting position of replacements is to be identical with originals. Before replacing any of these components, read carefully the PRODUCT SAFETY NOTICE. Do not degrade the safety of the receiver through improper servicing.

**NOTICE:**

- The part number must be used when ordering parts, in order to assist in processing, be sure to include the Model number and Description.
- The PC board assembly with \* mark is no longer available after the end of the production.

**Model : 36HFX71/32HFX71**

Capacitors ..... CD : Ceramic Disk      PF : Plastic Film      EL : Electrolytic  
 Resistors ..... CF : Carbon Film      CC : Carbon Composition      MF : Metal Film  
                          OMF : Oxide Metal Film      VR : Variable Resistor      FR : Fusible Resistor  
 (All CD and PF capacitors are ±5%, 50V and all resistors, ±5%, 1/6W unless otherwise noted.)

Location No.	Parts No.	Description
<b>CAPACITORS</b>		
C102	24762471	ELECTROLYTIC CE04G 10V 470UF M
C103	24109103	CERAMIC CHIP CK73B 50V 10000PF K
C105	24109102	CERAMIC CHIP CK73B 50V 1000PF K
C106	24797479	ELECTROLYTIC CE04G 50V 4.7UF M
C107	24794221	ELECTROLYTIC CE04G 16V 220UF M
C112	24762221	ELECTROLYTIC CE04G 10V 220UF M
C115	24109103	CERAMIC CHIP CK73B 50V 10000PF K
C117	24794221	ELECTROLYTIC CE04G 16V 220UF M
C151	24109102	CERAMIC CHIP CK73B 50V 1000PF K
C201	24092730	CERAMIC CHIP, 16V 0.1UF K
C205	24797229	ELECTROLYTIC, 50V 2.2UF M
C206	24794220	ELECTROLYTIC CE04G 16V 22UF M
C211	24092730	CERAMIC CHIP, 16V 0.1UF K
C303	24214471	CERAMIC DISK CK45 B 500V 470PF K
C304	24693473	PLASTIC FILM CQ921 M 100V 0.047MF J
C306	24795332	ELECTROLYTIC CE04G 25V 3300UF M
C308	24797221	ELECTROLYTIC CE04G 50V 220UF M
C310	24797222	ELECTROLYTIC CE04G 50V 2200UF M
C312	24503037	MT PLA CAP 63V 0.047UF J
C313	24082057	PLASTIC FILM CF922 M 100V 220000PF J
C314	24793101	ELECTROLYTIC CE04G 10V 100UF M
C315	24619071	MENNJISSOU, 2.2U UWX1H2R2MCR1
C315	24212222	CERAMIC DISK CK45 B 50V 2200PF K
C318	24073041	ELECTROLYTIC CE04P 16V 470UF M 3A
C319	24591103	PLASTIC FILM, 50V 0.01MF J
C320	24797101	ELECTROLYTIC CE04G 50V 100UF M
C322	24617912	ELECTROLYTIC, 50V 2.2UF K 3A LI
C323	24591474	PLASTIC FILM, 50V 0.47MF J
C325	24591203	PLASTIC FILM, 50V 0.020MF J
C326	24212102	CERAMIC DISK CK45 B 50V 1000PF K
C327	24073041	ELECTROLYTIC CE04P 16V 470UF M 3A
C352	24617915	ELECTROLYTIC CE04CH 50V 1.0UF K 3A LI
C361	24591123	PLASTIC FILM, 50V 0.012MF J
C362	24503041	MT PLA CAP 63V 0.1UF J
C370	24669101	ELECTROLYTIC, 50V 100UF M 3A
C371	24668100	ELECTROLYTIC, 35V 10UF M 3A
C391	24794100	ELECTROLYTIC CE04G 16V 10UF M

Location No.	Parts No.	Description
C392	24085961	ELEC. NONPOLAR CE04J 50V 10UF M 11L NP
C393	24794100	ELECTROLYTIC CE04G 16V 10UF M
C396	24082825	PLASTIC FILM CF92 T 1800VH 1800PF H
C402	24092463	CERAMIC CHIP CK732B 16V R22UF K
C404	24619071	MENNJISSOU, 2.2U UWX1H2R2MCR1
C406	24109223	CERAMIC CHIP CK73B 25V 22000PF K
C410	24105221	CERAMIC CHIP CC73CH 50V 220PF J
C410	24829563	PLASTIC FILM CQ92 T 400V 56000PF J
C413	24214392	CERAMIC DISK CK45 B 500V 3900PF K
C415	24109103	CERAMIC CHIP CK73B 50V 10000PF K
C416	24676330	ELECTROLYTIC CE04Q 100V 33UF M 3A
C417	24214391	CERAMIC DISK CK45 B 500V 390PF K
C424	24763101	ELECTROLYTIC CE04G 16V 100UF M
C425	24763101	ELECTROLYTIC CE04G 16V 100UF M
△ C428	24082647	PLASTIC FILM CF92 T 400V R27UF J
C430	24109103	CERAMIC CHIP CK73B 50V 10000PF K
C431	24763221	ELECTROLYTIC, 16V 220UF M
C432	24567474	PLASTIC FILM, 50V 0.47UF J
C434	24820332	PLASTIC FILM CQ92 T 630V 3300PF J
C435	24212101	CERAMIC DISK CK45 B 50V 100PF K
C436	24503041	MT PLA CAP 63V 0.1UF J
C437	24082399	PLASTIC FILM CF92 T 1250VH 1600PF H
C439	24829273	PLASTIC FILM CQ92 T 400V 27000PF J
△ C440	24082592	PLASTIC FILM CF92 T 1800VH 1000PF H
△ C442	24082648	MT PLA CAP T 400V 304J
△ C443	24082606	PLASTIC FILM CF92 T 1800VH 3900PF H
△ C444	24082606	PLASTIC FILM CF92 T 1800VH 3900PF H (36HFX71)
C444	24082599	CF92T3Q202H (32HFX71)
C445	24095740	PLASTIC FILM CF92 T 400V R047UF J
C446	24640020	ELECTROLYTIC CE04Q 250V 33UF M H-R
C448	24640962	CHEMICON 04H 200V 330M
C449	24667471	ELECTROLYTIC, 25V 470UF M 3A
C450	24092344	CERAMIC DISC CK45R 2KV 820PF K
C451	24092344	CERAMIC DISC CK45R 2KV 820PF K
C452	24082597	PLASTIC FILM, 1800VH 1600PF H
C461	24763101	ELECTROLYTIC CE04G 16V 100UF M
C463	24591223	PLASTIC FILM, 50V 0.022MF J

Location No.	Parts No.	Description
C464	24640900	CAPACITOR ELEC,CE04W 100V 4.7MF CE04W2A4R7
△ C465	24082429	PLASTIC FILM CF92 T 1250VH 10000PF H
C466	24503041	MT PLA CAP 63V 0.1UF J
△ C467	24082429	PLASTIC FILM CF92 T 1250VH 10000PF H
C468	24567474	PLASTIC FILM, 50V 0.47UF J
△ C469	24082429	PLASTIC FILM CF92 T 1250VH 10000PF H
C470	24766220	ELECTROLYTIC CE04G 50V 22UF M
C471	24766479	ELECTROLYTIC, 50V 4.7UF M
C472	24567474	PLASTIC FILM, 50V 0.47UF J
C475	24214102	CERAMIC DISK CK45 B 500V 1000PF K
C476	24214471	CERAMIC DISK CK45 B 500V 470PF K
C477	24666220	ELECTROLYTIC, 16V 22UF M 3A
C480	24794100	ELECTROLYTIC CE04G 16V 10UF M
C481	24214221	CERAMIC DISK CK45 B 500V 220PF K
C481	24794100	ELECTROLYTIC CE04G 16V 10UF M
C482	24109122	CERAMIC CHIP CC73B 50V 1200PF K
C488	24666100	ELECTROLYTIC, 10V 10UF M 3A
△ C491	24082645	PLASTIC FILM CF92 T 400V R22UF J (36HFX71)
△ C491	24082910	CF92T2F154J (32HFX71)
△ C492	24082645	PLASTIC FILM CF92 T 400V R22UF J (36HFX71)
△ C492	24082908	CF92T2F124J (32HFX71)
C497	24829243	PLASTIC FILM CQ92 T 400V 24000PF J
C499	24828823	PLASTIC FILM CQ92 T 200V 82000PF J
C501	24109103	CERAMIC CHIP CK73B 50V 10000PF K
C502	24092730	CERAMIC CHIP, 16V 0.1UF K
C503	24619151	MENJISSOU TYP 6.3V470U
C504	24109222	CERAMIC CHIP CK73B 50V 2200PF K
C505	24105120	CERAMIC CHIP CC73CH 50V 12PF J
C506	24105120	CERAMIC CHIP CC73CH 50V 12PF J
C507	24105120	CERAMIC CHIP CC73CH 50V 12PF J
C508	24100104	CERAMIC CHIP CK73F 25V 10000PF Z
C509	24619157	MENJISSOU TYP 16V100U
C510	24092730	CERAMIC CHIP, 16V 0.1UF K
C511	24619157	MENJISSOU TYP 16V100U
C512	24092463	CERAMIC CHIP CK732B 16V R22UF K
C513	24100104	CERAMIC CHIP CK73F 25V 10000PF Z
C513	24109103	CERAMIC CHIP CK73B 50V 10000PF K
C514	24619040	ELEC. CHIP CE24W 16V 10UF M 3A
C515	24100104	CERAMIC CHIP CK73F 25V 10000PF Z
C520	24539334	PLASTIC FILM, 50V 0.33UF J
C524	24092730	CERAMIC CHIP, 16V 0.1UF K
C525	24092730	CERAMIC CHIP, 16V 0.1UF K
C526	24092730	CERAMIC CHIP, 16V 0.1UF K
C527	24092730	CERAMIC CHIP, 16V 0.1UF K
C528	24092730	CERAMIC CHIP, 16V 0.1UF K
C529	24092730	CERAMIC CHIP, 16V 0.1UF K
C530	24797010	ELECTROLYTIC CE04G 50V 1.0UF M
C531	24100104	CERAMIC CHIP CK73F 25V 10000PF Z
C532	24100104	CERAMIC CHIP CK73F 25V 10000PF Z
C533	24100104	CERAMIC CHIP CK73F 25V 10000PF Z
C534	24100104	CERAMIC CHIP CK73F 25V 10000PF Z
C535	24092730	CERAMIC CHIP, 16V 0.1UF K
C536	24100104	CERAMIC CHIP CK73F 25V 10000PF Z
C537	24100104	CERAMIC CHIP CK73F 25V 10000PF Z
C540	24100104	CERAMIC CHIP CK73F 25V 10000PF Z
C541	24100104	CERAMIC CHIP CK73F 25V 10000PF Z
C542	24100104	CERAMIC CHIP CK73F 25V 10000PF Z
C546	24100104	CERAMIC CHIP CK73F 25V 10000PF Z
C547	24109103	CERAMIC CHIP CK73B 50V 10000PF K
C560	24797010	ELECTROLYTIC CE04G 50V 1.0UF M
C561	24797010	ELECTROLYTIC CE04G 50V 1.0UF M
C562	24797010	ELECTROLYTIC CE04G 50V 1.0UF M

Location No.	Parts No.	Description
C563	24797010	ELECTROLYTIC CE04G 50V 1.0UF M
C564	24797229	ELECTROLYTIC, 50V 2.2UF M
C565	24100104	CERAMIC CHIP CK73F 25V 100000PF Z
C566	24100104	CERAMIC CHIP CK73F 25V 100000PF Z
C567	24100104	CERAMIC CHIP CK73F 25V 100000PF Z
C573	24109103	CERAMIC CHIP CK73B 50V 10000PF K
C574	24109103	CERAMIC CHIP CK73B 50V 10000PF K
C598	24073042	ELECTROLYTIC CE04P 16V 1000UF M 3A
C599	24073042	ELECTROLYTIC CE04P 16V 1000UF M 3A
C612	24668101	ELECTROLYTIC CE04Q 35V 100UF M 3A
C613	24109103	CERAMIC CHIP CK73B 50V 10000PF K
C661	24109102	CERAMIC CHIP CK73B 50V 1000PF K
C662	24109102	CERAMIC CHIP CK73B 50V 1000PF K
C664	24794220	ELECTROLYTIC CE04G 16V 22UF M
C665	24794100	ELECTROLYTIC CE04G 16V 10UF M
C671	24669479	ELECTROLYTIC CE04Q 50V 4.7UF M 3A
C672	24669479	ELECTROLYTIC CE04Q 50V 4.7UF M 3A
C673	24669010	ELECTROLYTIC, 50V 1.0UF M 3A
C676	24503041	MT PLA CAP 63V 0.1UF J
C677	24503041	MT PLA CAP 63V 0.1UF J
C678	24669010	ELECTROLYTIC, 50V 1.0UF M 3A
C679	24667470	ELECTROLYTIC, 25V 47UF M 3A
C680	24109473	CERAMIC CHIP CK73B 25V 47000PFK
C681	24668471	ELECTROLYTIC, 35V 470UF M 3A
C682	24668102	ELECTROLYTIC CE04Q 35V 1000UF M 3A
C683	24668471	ELECTROLYTIC, 35V 470UF M 3A
C684	24668102	ELECTROLYTIC CE04Q 35V 1000UF M 3A
C686	24503041	MT PLA CAP 63V 0.1UF J
C704	24591822	PLASTIC FILM, 50V 8200PF J
C707	24794470	ELECTROLYTIC CE04G 16V 47UF M
C712	24666470	ELECTROLYTIC, 16V 47UF M 3A
C713	24709100	ELECTROLYTIC CE04G 200V 10UF M
C714	24436101	CERAMIC DISC CC45 SL 50V100PF J
C715	24214472	CERAMIC DISK CK45 B 500V 4700PF K
C716	24436101	CERAMIC DISC CC45 SL 50V100PF J
C717	24214472	CERAMIC DISK CK45 B 500V 4700PF K
C718	24766470	ELECTROLYTIC CE04G 50V 47UF M
C719	24435560	PCERA CAP SL 500V 560J
C720	24709100	ELECTROLYTIC CE04G 200V 10UF M
C721	24797470	ELECTROLYTIC, 50V 47UF M
C722	24436820	CERAMIC DISC CC45 SL 50V82PF J
C726	24212102	CERAMIC DISK CK45 B 50V 1000PF K
C801	24503002	MT PLA AC275V 0.22UF M
C805	24092623	CERAMIC DISC CKS45F 250V 10000PFZ
C806	24092623	CERAMIC DISC CKS45F 250V 10000PFZ
C807	24214103	CERAMIC DISK CK45 B 500V 10000PF K
C810	24086933	200V 1000M30F
C811	24092597	CERAMIC DISC CK45E AC250V 4700PF M
C812	24092597	CERAMIC DISC CK45E AC250V 4700PF M
C813	24092598	CERAMIC DISC CK45F AC250V 10000PF M
C814	24092598	CERAMIC DISC CK45F AC250V 10000PF M
C821	24794102	ELECTROLYTIC CE04G 16V 1000UF M
C822	24539334	PLASTIC FILM, 50V 0.33UF J
C823	24539334	PLASTIC FILM, 50V 0.33UF J
C824	24539334	PLASTIC FILM, 50V 0.33UF J
C825	24539334	PLASTIC FILM, 50V 0.33UF J
C826	24539334	PLASTIC FILM, 50V 0.33UF J
C827	24539334	PLASTIC FILM, 50V 0.33UF J
C828	24539334	PLASTIC FILM, 50V 0.33UF J
C829	24794470	ELECTROLYTIC CE04G 16V 47UF M
C837	24503041	MT PLA CAP 63V 0.1UF J
C838	24617026	ELECTROLYTIC, 820UF, 16V, M
C839	24794102	ELECTROLYTIC CE04G 16V 1000UF M
C840	24667222	ELECTROLYTIC CE04Q 25V 2200UF M 3A
C841	24503041	MT PLA CAP 63V 0.1UF J

Location No.	Parts No.	Description
C842	24792101	ELECTROLYTIC CE04G 6.3V 100UF M
C844	24503041	MT PLA CAP 63V 0.1UF J
C846	24214331	CERAMIC DISK CK45 B 500V 330PF K
C847	24669339	ELECTROLYTIC, 50V 3.3UF M
C848	24794102	ELECTROLYTIC CE04G 16V 1000UF M
C850	24539334	PLASTIC FILM, 50V 0.33UF J
C851	24539334	PLASTIC FILM, 50V 0.33UF J
C860	24214103	CERAMIC DISK CK45 B 500V 10000PF K
C862	24435221	CERA CAP SL 500V 221J
C863	24503041	MT PLA CAP 63V 0.1UF J
C864	24092347	CERAMIC DISC CK45R 2KV 1500PF K
C865	24092347	CERAMIC DISC CK45R 2KV 1500PF K
C866	24669010	ELECTROLYTIC, 50V 1.0UF M 3A
C867	24591682	PLASTIC FILM, 50V 6800PF J
C868	24668470	ELECTROLYTIC CE04Q 35V 47UF M 3A
C869	24678229	ELECTROLYTIC CE04Q 200 2.2UF M 3A
C870	24820184	PLASTIC FILM CQ92 T 630V R18UF J
C871	24092347	CERAMIC DISC CK45R 2KV 1500PF K
C873	24567224	PLASTIC FILM, 50V 0.22UF J
C874	24435221	CERA CAP SL 500V 221J
C876	24503041	MT PLA CAP 63V 0.1UF J
C877	24092347	CERAMIC DISC CK45R 2KV 1500PF K
C879	24212101	CERAMIC DISK CK45 B 50V 100PF K
C881	24214471	CERAMIC DISK CK45 B 500V 470PF K
C882	24214471	CERAMIC DISK CK45 B 500V 470PF K
C884	24086049	ELECTROLYTIC CE692J 160V 330UF M 3D
C885	24214471	CERAMIC DISK CK45 B 500V 470PF K
C886	24214471	CERAMIC DISK CK45 B 500V 470PF K
C889	24668332	ELECTROLYTIC CE04Q 35V 3300UF M 3A
C891	24082229	PLASTIC FILM, 0.1MFD, 250V
C893	24092335	CERAMIC DISC CK45R 2KV 150PF K
C894	24092335	CERAMIC DISC CK45R 2KV 150PF K
C895	24796471	ELECTROLYTIC CE04G 35V 470UF M
C896	24214471	CERAMIC DISK CK45 B 500V 470PF K
C897	24617044	ELECTROLYTIC, 35V 2200UF M
C898	24503041	MT PLA CAP 63V 0.1UF J
C899	24214471	CERAMIC DISK CK45 B 500V 470PF K
C902	24092353	CERAMIC DISC CK45R 2KV 4700PF K
C904	24436471	CERAMIC DISC CC45 SL 50V470PF J
C905	24436391	CERAMIC DISC CC45 SL 50V390PF J
C907	24436561	CERAMIC DISC CC45 SL 50V560PF J
C909	24679220	ELECTROLYTIC CE04Q 250V 22UF M 3A
C910	24669478	ELECTROLYTIC, 50V 0.47UF M 3A
C911	24203100	ELECTROLYTIC CE04WS 16V 10UF M 7L 3A
C912	24073042	ELECTROLYTIC CE04P 16V 1000UF M 3A
C913	24666102	ELECTROLYTIC, 16V 1000UF M 3A
C918	24503041	MT PLA CAP 63V 0.1UF J
C919	24503041	MT PLA CAP 63V 0.1UF J
C920	24503041	MT PLA CAP 63V 0.1UF J
C921	24503041	MT PLA CAP 63V 0.1UF J
C922	24436390	CERAMIC DISC CC45SL 50V 39PFJ
C923	24794470	ELECTROLYTIC CE04G 16V 47UF M
C924	24794470	ELECTROLYTIC CE04G 16V 47UF M
C925	24794470	ELECTROLYTIC CE04G 16V 47UF M
C931	24214101	CERAMIC DISK CK45 B 500V 100PF K
C2061	24100104	CERAMIC CHIP CK73F 25V 10000PF Z
C2102	24105100	CERAMIC CHIP CC73CH 50V 10PF D
C2103	24105100	CERAMIC CHIP CC73CH 50V 10PF D
C2104	24105100	CERAMIC CHIP CC73CH 50V 10PF D
C2110	24109103	CERAMIC CHIP CK73B 50V 10000PF K
C3110	24085988	ELEC. NONPOLAR CE04J 50V 1.0UF M 7L NP
C4030	24109103	CERAMIC CHIP CK73B 50V 10000PF K
C4404	24100104	CERAMIC CHIP CK73F 25V 10000PF Z
C4405	24100104	CERAMIC CHIP CK73F 25V 10000PF Z

Location No.	Parts No.	Description
C4406	24109103	CERAMIC CHIP CK73B 50V 10000PF K
C4407	24766010	ELECTROLYTIC CE04G 50V 1.0UF M
C4408	24109103	CERAMIC CHIP CK73B 50V 10000PF K
C4415	24109472	CERAMIC CHIP CK73B 50V 4700PF K
C4421	24085988	ELEC. NONPOLAR CE04J 50V 1.0UF M 7L NP
C4425	24109222	CERAMIC CHIP CK73B 50V 2200PF K
C4426	24763331	ELECTROLYTIC CE04G 16V 330UF M
C4427	24085988	ELEC. NONPOLAR CE04J 50V 1.0UF M 7L NP
C4461	24539184	PLASTIC FILM CF922 50V 0.18UF
C4463	24567224	PLASTIC FILM, 50V 0.22UF J
C4464	24766010	ELECTROLYTIC CE04G 50V 1.0UF M
C4699	24668222	ELECTROLYTIC CE04Q 35V 2200UF M 3A
C4816	24669010	ELECTROLYTIC, 50V 1.0UF M 3A
C4817	24590102	PLASTIC FILM, 50V 1000PF J
C4818	24503041	MT PLA CAP 63V 0.1UF J
C4819	24567684	PLASTIC FILM, 50V 0.68UF J
C5020	24109103	CERAMIC CHIP CK73B 50V 10000PF K
C5030	24794101	ELECTROLYTIC, 16V 100UF M
C5088	24797010	ELECTROLYTIC CE04G 50V 1.0UF M
C5090	24794101	ELECTROLYTIC, 16V 100UF M
C5280	24105101	CERAMIC CHIP CC73CH 50V 100PF J
C8601	24214103	CERAMIC DISK CK45 B 500V 10000PF K
CA04	24109103	CERAMIC CHIP CK73B 50V 10000PF K
CA05	24109103	CERAMIC CHIP CK73B 50V 10000PF K
CA06	24109392	CERAMIC CHIP CK73B 50V 3900PF K
CA07	24109392	CERAMIC CHIP CK73B 50V 3900PF K
CA23	24105101	CERAMIC CHIP CC73CH 50V 100PF J
CA25	24109103	CERAMIC CHIP CK73B 50V 10000PF K
CA27	24092538	CERAMIC CHIP CK73F 10V 1UF Z
CA28	24085970	ELEC. NONPOLAR CE04J 16V 10UF M 7L NP
CA30	24085970	ELEC. NONPOLAR CE04J 16V 10UF M 7L NP
CA31	24092538	CERAMIC CHIP CK73F 10V 1UF Z
CA33	24100103	CERAMIC CHIP CK73F 50V 10000PF Z
CA34	24092538	CERAMIC CHIP CK73F 10V 1UF Z
CA37	24105101	CERAMIC CHIP CC73CH 50V 100PF J
CA38	24105101	CERAMIC CHIP CC73CH 50V 100PF J
CA39	24105101	CERAMIC CHIP CC73CH 50V 100PF J
CA42	24109392	CERAMIC CHIP CK73B 50V 3900PF K
CA45	24105471	CERAMIC CHIP CC73CH 50V 470pF J
CA46	24105101	CERAMIC CHIP CC73CH 50V 100PF J
CA49	24105101	CERAMIC CHIP CC73CH 50V 100PF J
CA54	24092730	CERAMIC CHIP, 16V 0.1UF K
CA57	24105101	CERAMIC CHIP CC73CH 50V 100PF J
CA60	24105101	CERAMIC CHIP CC73CH 50V 100PF J
CA61	24666220	ELECTROLYTIC, 16V 22UF M 3A
CA69	24109103	CERAMIC CHIP CK73B 50V 10000PF K
CA71	24105331	CERAMIC CHIP CC73CH 50V 330pF J
CA72	24085970	ELEC. NONPOLAR CE04J 16V 10UF M 7L NP
CA73	24666100	ELECTROLYTIC, 10V 10UF M 3A
CA80	24503041	MT PLA CAP 63V 0.1UF J
CA81	24073015	ELECTROLYTIC CE04P 10V 47UF M 3A
CA82	24539474	MT PLA CAP M 50V 474J MUL
CA95	24100103	CERAMIC CHIP CK73F 50V 10000PF Z
CA98	24797220	ELECTROLYTIC CE04G 50V 22UF M
CA251	24073015	ELECTROLYTIC CE04P 10V 47UF M 3A
CA331	24073015	ELECTROLYTIC CE04P 10V 47UF M 3A
CA611	24100103	CERAMIC CHIP CK73F 50V 10000PF Z
CA680	24666100	ELECTROLYTIC, 10V 10UF M 3A
CA701	24092538	CERAMIC CHIP CK73F 10V 1UF Z
CA705	24666100	ELECTROLYTIC, 10V 10UF M 3A

Location No.	Parts No.	Description
CB01	24794470	ELECTORLYTIC CE04G 16V 47UF M
CB05	24666100	ELECTROLYTIC, 10V 10UF M 3A
CB13	24085970	ELEC. NONPOLAR CE04J 16V 10UF M 7L NP
CB14	24105331	CERAMIC CHIP CC73CH 50V 330pF J
CB15	24794100	ELECTROLYTIC CE04G 16V 10UF M
CB40	24797010	ELECTROLYTIC CE04G 50V 1.0UF M
CB41	24109102	CERAMIC CHIP CK73B 50V 1000PF K
CB42	24105561	CERAMIC CHIP CC73CH 50V 560PF J
CB43	24109122	CERAMIC CHIP CC73B 50V 1200PF K
CB44	24797100	ELECTROLYTIC CE04G 50V 10UF M
CB90	24100103	CERAMIC CHIP CK73F 50V 10000PF Z
CD01	24797100	ELECTROLYTIC CE04G 50V 10UF M
CD02	24539104	PLASTIC FILM, 50V 0.1UF J
CD03	24590472	PLASTIC FILM CQ922M 50V 4700PF J
CD04	24797479	ELECTROLYTIC CE04G 50V 4.7UF M
CD05	24797479	ELECTROLYTIC CE04G 50V 4.7UF M
CD06	24797479	ELECTROLYTIC CE04G 50V 4.7UF M
CD07	24797479	ELECTROLYTIC CE04G 50V 4.7UF M
CD08	24797100	ELECTROLYTIC CE04G 50V 10UF M
CD09	24797220	ELECTROLYTIC CE04G 50V 22UF M
CD10	24797100	ELECTROLYTIC CE04G 50V 10UF M
CD11	24539104	PLASTIC FILM, 50V 0.1UF J
CD12	24539224	PLASTIC FILM, 50V 0.22 UF J
CD13	24794470	ELECTORLYTIC CE04G 16V 47UF M
CD14	24590472	PLASTIC FILM CQ922M 50V 4700PF J
CD15	24539104	PLASTIC FILM, 50V 0.1UF J
CD17	24797100	ELECTROLYTIC CE04G 50V 10UF M
CD18	24794221	ELECTROIYTIC CE04G 16V 220UF M
CD41	24503041	MT PLA CAP 63V 0.1UF J
CD42	24590103	PLASTIC FILM, 50V 0.01MF J
CD43	24503041	MT PLA CAP 63V 0.1UF J
CD44	24503041	MT PLA CAP 63V 0.1UF J
CD45	24539184	PLASTIC FILM CF922 50V 0.18UF
CD46	24539184	PLASTIC FILM CF922 50V 0.18UF
CD47	24539334	PLASTIC FILM, 50V 0.33UF J
CD48	24539334	PLASTIC FILM, 50V 0.33UF J
CD49	24797010	ELECTROLYTIC CE04G 50V 1.0UF M
CD60	24797100	ELECTROLYTIC CE04G 50V 10UF M
CD61	24567333	PLASTIC FILM CF92 M 50V 33000PF J
CD62	24590103	PLASTIC FILM, 50V 0.01MF J
CD63	24539474	MT PLA CAP M 50V 474J MUL
CD64	24539334	PLASTIC FILM, 50V 0.33UF J
CD65	24436221	CERAMIC DISC CC45 SL 50V 220PF J
CD70	24794221	ELECTROIYTIC CE04G 16V 220UF M
CD73	24797100	ELECTROLYTIC CE04G 50V 10UF M
CD74	24794221	ELECTROIYTIC CE04G 16V 220UF M
CD75	24797100	ELECTROLYTIC CE04G 50V 10UF M
CD76	24797100	ELECTROLYTIC CE04G 50V 10UF M
CD77	24797100	ELECTROLYTIC CE04G 50V 10UF M
CD79	24797220	ELECTROLYTIC CE04G 50V 22UF M
CD80	24797220	ELECTROLYTIC CE04G 50V 22UF M
CD81	24503041	MT PLA CAP 63V 0.1UF J
CD82	24503041	MT PLA CAP 63V 0.1UF J
CD83	24503041	MT PLA CAP 63V 0.1UF J
CD84	24503041	MT PLA CAP 63V 0.1UF J
CD85	24797100	ELECTROLYTIC CE04G 50V 10UF M
CD86	24797100	ELECTROLYTIC CE04G 50V 10UF M
CD87	24797100	ELECTROLYTIC CE04G 50V 10UF M
CD88	24797100	ELECTROLYTIC CE04G 50V 10UF M
CD103	24797220	ELECTROLYTIC CE04G 50V 22UF M
CD104	24590102	PLASTIC FILM, 50V 1000PF J
CD105	24539124	PLASTEC FILM, 50V 0.12UF J
CD106	24539104	PLASTIC FILM, 50V 0.1UF J
CD107	24539563	MT PLA CAP M 50V 563J MUL

Location No.	Parts No.	Description
CD108	24797010	ELECTROLYTIC CE04G 50V 1.0UF M
CD109	24797100	ELECTROLYTIC CE04G 50V 10UF M
CD110	24590103	PLASTIC FILM, 50V 0.01MF J
CD111	24797100	ELECTROLYTIC CE04G 50V 10UF M
CD113	24797010	ELECTROLYTIC CE04G 50V 1.0UF M
CD114	24797010	ELECTROLYTIC CE04G 50V 1.0UF M
CD115	24797010	ELECTROLYTIC CE04G 50V 1.0UF M
CD116	24590103	PLASTIC FILM, 50V 0.01MF J
CD117	24590103	PLASTIC FILM, 50V 0.01MF J
CD118	24567273	PLASTIC FILM CF92 M 50V 27000PF J
CD120	24794221	ELECTROIYTIC CE04G 16V 220UF M
CD121	24590822	PLASTIC FILM, 50V 8200PF J
CD123	24797220	ELECTROLYTIC CE04G 50V 22UF M
CD124	24797010	ELECTROLYTIC CE04G 50V 1.0UF M
CD125	24567273	PLASTIC FILM CF92 M 50V 27000PF J
CD126	24590822	PLASTIC FILM, 50V 8200PF J
CD128	24797220	ELECTROLYTIC CE04G 50V 22UF M
CR12	24100104	CERAMIC CHIP CK73F 25V 100000PF Z
CR13	24100104	CERAMIC CHIP CK73F 25V 100000PF Z
CR14	24100104	CERAMIC CHIP CK73F 25V 100000PF Z
CR90	24100104	CERAMIC CHIP CK73F 25V 100000PF Z
CS03	24105221	CERAMIC CHIP CC73CH 50V 220PF J
CS04	24797010	ELECTROLYTIC CE04G 50V 1.0UF M
CS07	24105221	CERAMIC CHIP CC73CH 50V 220PF J
CS08	24797010	ELECTROLYTIC CE04G 50V 1.0UF M
CS09	24105331	CERAMIC CHIP CC73CH 50V 330pF J
CS10	24797229	ELECTROLYTIC, 50V 2.2UF M
CS11	24797010	ELECTROLYTIC CE04G 50V 1.0UF M
CS12	24105221	CERAMIC CHIP CC73CH 50V 220PF J
CS13	24797010	ELECTROLYTIC CE04G 50V 1.0UF M
CS14	24105221	CERAMIC CHIP CC73CH 50V 220PF J
CS15	24105331	CERAMIC CHIP CC73CH 50V 330pF J
CS16	24797229	ELECTROLYTIC, 50V 2.2UF M
CS21	24105101	CERAMIC CHIP CC73CH 50V 100PF J
CS22	24105101	CERAMIC CHIP CC73CH 50V 100PF J
CS24	24105331	CERAMIC CHIP CC73CH 50V 330pF J
CS25	24797229	ELECTROLYTIC, 50V 2.2UF M
CS28	24105331	CERAMIC CHIP CC73CH 50V 330pF J
CS29	24105331	CERAMIC CHIP CC73CH 50V 330pF J
CS30	24797229	ELECTROLYTIC, 50V 2.2UF M
CS32	24794100	ELECTROLYTIC CE04G 16V 10UF M
CS33	24794100	ELECTROLYTIC CE04G 16V 10UF M
CS34	24105331	CERAMIC CHIP CC73CH 50V 330pF J
CS35	24797229	ELECTROLYTIC, 50V 2.2UF M
CS36	24797229	ELECTROLYTIC, 50V 2.2UF M
CS51	24797229	ELECTROLYTIC, 50V 2.2UF M
CS52	24797229	ELECTROLYTIC, 50V 2.2UF M
CS53	24797229	ELECTROLYTIC, 50V 2.2UF M
CS54	24797229	ELECTROLYTIC, 50V 2.2UF M
CS55	24105331	CERAMIC CHIP CC73CH 50V 330pF J
CS56	24105331	CERAMIC CHIP CC73CH 50V 330pF J
CS57	24105331	CERAMIC CHIP CC73CH 50V 330pF J
CS58	24105331	CERAMIC CHIP CC73CH 50V 330pF J
CS60	24503041	MT PLA CAP 63V 0.1UF J
CS115	24797010	ELECTROLYTIC CE04G 50V 1.0UF M
CS116	24797010	ELECTROLYTIC CE04G 50V 1.0UF M
CS118	24794470	ELECTORLYTIC CE04G 16V 47UF M
CS119	24797010	ELECTROLYTIC CE04G 50V 1.0UF M
CS120	24797010	ELECTROLYTIC CE04G 50V 1.0UF M
CS121	24797010	ELECTROLYTIC CE04G 50V 1.0UF M
CS122	24797101	ELECTROLYTIC CE04G 50V 100UF M
CS123	24797470	ELECTROLYTIC, 50V 47UF M
CS124	24797229	ELECTROLYTIC, 50V 2.2UF M
CS125	24590103	PLASTIC FILM, 50V 0.01MF J
CS652	24794220	ELECTROLYTIC CE04G 16V 22UF M

Location No.	Parts No.	Description
CS676	24100103	CERAMIC CHIP CK73F 50V 10000PF Z
CV01	24794100	ELECTROLYTIC CE04G 16V 10UF M
CV02	24100103	CERAMIC CHIP CK73F 50V 10000PF Z
CV04	24794100	ELECTROLYTIC CE04G 16V 10UF M
CV05	24794100	ELECTROLYTIC CE04G 16V 10UF M
CV07	24794100	ELECTROLYTIC CE04G 16V 10UF M
CV08	24763102	ELECTROLYTIC CE04G 16V 1000UF M
CV12	24794100	ELECTROLYTIC CE04G 16V 10UF M
CV18	24794100	ELECTROLYTIC CE04G 16V 10UF M
CV21	24794100	ELECTROLYTIC CE04G 16V 10UF M
CV22	24794100	ELECTROLYTIC CE04G 16V 10UF M
CV23	24100103	CERAMIC CHIP CK73F 50V 10000PF Z
CV27	24762471	ELECTROLYTIC CE04G 10V 470UF M
CV29	24794101	ELECTROLYTIC, 16V 100UF M
CV30	24100103	CERAMIC CHIP CK73F 50V 10000PF Z
CV75	24100103	CERAMIC CHIP CK73F 50V 10000PF Z
CV90	24794100	ELECTROLYTIC CE04G 16V 10UF M
CV91	24794100	ELECTROLYTIC CE04G 16V 10UF M
CV92	24794100	ELECTROLYTIC CE04G 16V 10UF M
CV100	24794100	ELECTROLYTIC CE04G 16V 10UF M
CV120	24794100	ELECTROLYTIC CE04G 16V 10UF M
CV246	24100103	CERAMIC CHIP CK73F 50V 10000PF Z
CV247	24794470	ELECTORLYTIC CE04G 16V 47UF M
CV248	24794470	ELECTORLYTIC CE04G 16V 47UF M
CV262	24794470	ELECTORLYTIC CE04G 16V 47UF M
CV266	24794470	ELECTORLYTIC CE04G 16V 47UF M
CV269	24794470	ELECTORLYTIC CE04G 16V 47UF M
CV272	24794470	ELECTORLYTIC CE04G 16V 47UF M
CV275	24794470	ELECTORLYTIC CE04G 16V 47UF M
CV501	24619157	MENJISSOU TYP 16V100U
CV505	24109103	CERAMIC CHIP CK73B 50V 10000PF K
CW08	24794100	ELECTROLYTIC CE04G 16V 10UF M
CW09	24100103	CERAMIC CHIP CK73F 50V 10000PF Z
CX101	24619046	MENJISSOU, 470U UWX1C470MCR1
CX102	24619046	MENJISSOU, 470U UWX1C470MCR1
CX111	24100104	CERAMIC CHIP CK73F 25V 10000PF Z
CX112	24105181	CERAMIC CHIP CC73CH 50V 180PF J
CX113	24105820	CERAMIC CHIP CC73CH 50V 82PF J
CX114	24105101	CERAMIC CHIP CC73CH 50V 100PF J
CX115	24092616	CERAMIC CHIP CK732B 16V 330000PF K
CX116	24100104	CERAMIC CHIP CK73F 25V 10000PF Z
CX117	24619042	ELEC. CHIP CE24W 16V 22UF M 3A
CX118	24100104	CERAMIC CHIP CK73F 25V 10000PF Z
CX119	24105820	CERAMIC CHIP CC73CH 50V 82PF J
CX121	24100104	CERAMIC CHIP CK73F 25V 10000PF Z
CX122	24105121	CERAMIC CHIP CC73CH 50V 120PF J
CX123	24105151	CERAMIC CHIP CC73CH 50V 150PF J
CX124	24105331	CERAMIC CHIP CC73CH 50V 330pF J
CX125	24092616	CERAMIC CHIP CK732B 16V 330000PF K
CX126	24100104	CERAMIC CHIP CK73F 25V 10000PF Z
CX127	24619042	ELEC. CHIP CE24W 16V 22UF M 3A
CX128	24100104	CERAMIC CHIP CK73F 25V 10000PF Z
CX131	24100104	CERAMIC CHIP CK73F 25V 10000PF Z
CX132	24105121	CERAMIC CHIP CC73CH 50V 120PF J
CX133	24105151	CERAMIC CHIP CC73CH 50V 150PF J
CX134	24105331	CERAMIC CHIP CC73CH 50V 330pF J
CX135	24092616	CERAMIC CHIP CK732B 16V 330000PF K
CX136	24100104	CERAMIC CHIP CK73F 25V 10000PF Z
CX137	24619042	ELEC. CHIP CE24W 16V 22UF M 3A
CX141	24100104	CERAMIC CHIP CK73F 25V 10000PF Z
CX142	24105181	CERAMIC CHIP CC73CH 50V 180PF J
CX143	24105820	CERAMIC CHIP CC73CH 50V 82PF J
CX144	24105121	CERAMIC CHIP CC73CH 50V 120PF J
CX145	24092616	CERAMIC CHIP CK732B 16V 330000PF K
CX146	24100104	CERAMIC CHIP CK73F 25V 10000PF Z

Location No.	Parts No.	Description
CX147	24619042	ELEC. CHIP CE24W 16V 22UF M 3A
CX151	24100104	CERAMIC CHIP CK73F 25V 100000PF Z
CX152	24105121	CERAMIC CHIP CC73CH 50V 120PF J
CX153	24105151	CERAMIC CHIP CC73CH 50V 150PF J
CX154	24105331	CERAMIC CHIP CC73CH 50V 330pF J
CX155	24092616	CERAMIC CHIP CK732B 16V 330000PF K
CX156	24100104	CERAMIC CHIP CK73F 25V 100000PF Z
CX157	24619042	ELEC. CHIP CE24W 16V 22UF M 3A
CX161	24100104	CERAMIC CHIP CK73F 25V 100000PF Z
CX162	24105121	CERAMIC CHIP CC73CH 50V 120PF J
CX163	24105151	CERAMIC CHIP CC73CH 50V 150PF J
CX164	24105331	CERAMIC CHIP CC73CH 50V 330pF J
CX165	24092616	CERAMIC CHIP CK732B 16V 330000PF K
CX166	24100104	CERAMIC CHIP CK73F 25V 100000PF Z
CX167	24619042	ELEC. CHIP CE24W 16V 22UF M 3A
CX171	24100104	CERAMIC CHIP CK73F 25V 100000PF Z
CX172	24100104	CERAMIC CHIP CK73F 25V 100000PF Z
CX173	24619070	MENJISSOU, 1U 50V UWX1H010MCR1
CX174	24619157	MENJISSOU TYP 16V100U
CX175	24100104	CERAMIC CHIP CK73F 25V 100000PF Z
CX176	24619157	MENJISSOU TYP 16V100U
CX177	24100104	CERAMIC CHIP CK73F 25V 100000PF Z
CX178	24619040	ELEC. CHIP CE24W 16V 10UF M 3A
CX179	24100104	CERAMIC CHIP CK73F 25V 100000PF Z
CX181	24105101	CERAMIC CHIP CC73CH 50V 100PF J
CX182	24105101	CERAMIC CHIP CC73CH 50V 100PF J
CX183	24105101	CERAMIC CHIP CC73CH 50V 100PF J
CX184	24105101	CERAMIC CHIP CC73CH 50V 100PF J
CX185	24105101	CERAMIC CHIP CC73CH 50V 100PF J
CX186	24105101	CERAMIC CHIP CC73CH 50V 100PF J
CX193	24092730	CERAMIC CHIP, 16V 0.1UF K
CX205	24109103	CERAMIC CHIP CK73B 50V 10000PF K
CX206	24100104	CERAMIC CHIP CK73F 25V 100000PF Z
CX207	24100104	CERAMIC CHIP CK73F 25V 100000PF Z
CX221	24619040	ELEC. CHIP CE24W 16V 10UF M 3A
CX222	24100104	CERAMIC CHIP CK73F 25V 100000PF Z
CX223	24100104	CERAMIC CHIP CK73F 25V 100000PF Z
CX224	24100104	CERAMIC CHIP CK73F 25V 100000PF Z
CX225	24100104	CERAMIC CHIP CK73F 25V 100000PF Z
CX226	24100104	CERAMIC CHIP CK73F 25V 100000PF Z
CX227	24100104	CERAMIC CHIP CK73F 25V 100000PF Z
CX228	24100104	CERAMIC CHIP CK73F 25V 100000PF Z
CX229	24100104	CERAMIC CHIP CK73F 25V 100000PF Z
CX230	24619040	ELEC. CHIP CE24W 16V 10UF M 3A
CX241	24619040	ELEC. CHIP CE24W 16V 10UF M 3A
CX242	24100104	CERAMIC CHIP CK73F 25V 100000PF Z
CX243	24100104	CERAMIC CHIP CK73F 25V 100000PF Z
CX244	24100104	CERAMIC CHIP CK73F 25V 100000PF Z
CX245	24100104	CERAMIC CHIP CK73F 25V 100000PF Z
CX246	24100104	CERAMIC CHIP CK73F 25V 100000PF Z
CX248	24100104	CERAMIC CHIP CK73F 25V 100000PF Z
CX249	24100104	CERAMIC CHIP CK73F 25V 100000PF Z
CX250	24619040	ELEC. CHIP CE24W 16V 10UF M 3A
CX252	24100104	CERAMIC CHIP CK73F 25V 100000PF Z
CX253	24100104	CERAMIC CHIP CK73F 25V 100000PF Z
CX257	24100104	CERAMIC CHIP CK73F 25V 100000PF Z
CX261	24619040	ELEC. CHIP CE24W 16V 10UF M 3A
CX262	24100104	CERAMIC CHIP CK73F 25V 100000PF Z
CX263	24100104	CERAMIC CHIP CK73F 25V 100000PF Z
CX264	24100104	CERAMIC CHIP CK73F 25V 100000PF Z
CX265	24100104	CERAMIC CHIP CK73F 25V 100000PF Z
CX266	24100104	CERAMIC CHIP CK73F 25V 100000PF Z
CX267	24100104	CERAMIC CHIP CK73F 25V 100000PF Z
CX269	24100104	CERAMIC CHIP CK73F 25V 100000PF Z
CX270	24619040	ELEC. CHIP CE24W 16V 10UF M 3A

Location No.	Parts No.	Description
CX301	24619151	MENJISSOU TYP 6.3V470U
CX302	24619151	MENJISSOU TYP 6.3V470U
CX303	24100104	CERAMIC CHIP CK73F 25V 10000PF Z
CX304	24092538	CERAMIC CHIP CK73F 10V 1UF Z
CX305	24100104	CERAMIC CHIP CK73F 25V 10000PF Z
CX306	24100104	CERAMIC CHIP CK73F 25V 10000PF Z
CX307	24092538	CERAMIC CHIP CK73F 10V 1UF Z
CX308	24100104	CERAMIC CHIP CK73F 25V 10000PF Z
CX309	24100104	CERAMIC CHIP CK73F 25V 10000PF Z
CX310	24100104	CERAMIC CHIP CK73F 25V 10000PF Z
CX311	24100104	CERAMIC CHIP CK73F 25V 10000PF Z
CX312	24100104	CERAMIC CHIP CK73F 25V 10000PF Z
CX313	24100104	CERAMIC CHIP CK73F 25V 10000PF Z
CX314	24100104	CERAMIC CHIP CK73F 25V 10000PF Z
CX315	24092538	CERAMIC CHIP CK73F 10V 1UF Z
CX316	24092538	CERAMIC CHIP CK73F 10V 1UF Z
CX317	24092538	CERAMIC CHIP CK73F 10V 1UF Z
CX318	24092538	CERAMIC CHIP CK73F 10V 1UF Z
CX319	24092538	CERAMIC CHIP CK73F 10V 1UF Z
CX320	24100104	CERAMIC CHIP CK73F 25V 10000PF Z
CX321	24092538	CERAMIC CHIP CK73F 10V 1UF Z
CX322	24100104	CERAMIC CHIP CK73F 25V 10000PF Z
CX323	24092538	CERAMIC CHIP CK73F 10V 1UF Z
CX324	24092538	CERAMIC CHIP CK73F 10V 1UF Z
CX325	24092538	CERAMIC CHIP CK73F 10V 1UF Z
CX326	24100104	CERAMIC CHIP CK73F 25V 10000PF Z
CX327	24092538	CERAMIC CHIP CK73F 10V 1UF Z
CX328	24092538	CERAMIC CHIP CK73F 10V 1UF Z
CX329	24100104	CERAMIC CHIP CK73F 25V 10000PF Z
CX330	24100104	CERAMIC CHIP CK73F 25V 10000PF Z
CX331	24092538	CERAMIC CHIP CK73F 10V 1UF Z
CX332	24100104	CERAMIC CHIP CK73F 25V 10000PF Z
CX340	24619148	MENJISSOU TYP 6.3V100U
CX341	24100104	CERAMIC CHIP CK73F 25V 10000PF Z
CX342	24100104	CERAMIC CHIP CK73F 25V 10000PF Z
CX343	24092538	CERAMIC CHIP CK73F 10V 1UF Z
CX344	24092538	CERAMIC CHIP CK73F 10V 1UF Z
CX345	24092730	CERAMIC CHIP, 16V 0.1UF K
CX346	24100104	CERAMIC CHIP CK73F 25V 10000PF Z
CX347	24092730	CERAMIC CHIP, 16V 0.1UF K
CX348	24092730	CERAMIC CHIP, 16V 0.1UF K
CX349	24100104	CERAMIC CHIP CK73F 25V 10000PF Z
CX350	24092730	CERAMIC CHIP, 16V 0.1UF K
CX351	24105330	CERAMIC CHIP CC73CH 50V 33PF J
CX352	24105330	CERAMIC CHIP CC73CH 50V 33PF J
CX361	24100104	CERAMIC CHIP CK73F 25V 10000PF Z
CX362	24100104	CERAMIC CHIP CK73F 25V 10000PF Z
CX363	24100104	CERAMIC CHIP CK73F 25V 10000PF Z
CX364	24100104	CERAMIC CHIP CK73F 25V 10000PF Z
CX365	24100104	CERAMIC CHIP CK73F 25V 10000PF Z
CX366	24619040	ELEC. CHIP CE24W 16V 10UF M 3A
CX367	24100104	CERAMIC CHIP CK73F 25V 10000PF Z
CX368	24100104	CERAMIC CHIP CK73F 25V 10000PF Z
CX369	24092538	CERAMIC CHIP CK73F 10V 1UF Z
CX370	24619151	MENJISSOU TYP 6.3V470U
CX371	24092538	CERAMIC CHIP CK73F 10V 1UF Z
CX372	24100104	CERAMIC CHIP CK73F 25V 10000PF Z
CX373	24092538	CERAMIC CHIP CK73F 10V 1UF Z
CX374	24100104	CERAMIC CHIP CK73F 25V 10000PF Z
CX375	24092538	CERAMIC CHIP CK73F 10V 1UF Z
CX376	24100104	CERAMIC CHIP CK73F 25V 10000PF Z
CX377	24092538	CERAMIC CHIP CK73F 10V 1UF Z
CX381	24092538	CERAMIC CHIP CK73F 10V 1UF Z
CX382	24092538	CERAMIC CHIP CK73F 10V 1UF Z
CX383	24100104	CERAMIC CHIP CK73F 25V 10000PF Z

Location No.	Parts No.	Description
CX384	24092538	CERAMIC CHIP CK73F 10V 1UF Z
CX385	24100104	CERAMIC CHIP CK73F 25V 10000PF Z
CX386	24092538	CERAMIC CHIP CK73F 10V 1UF Z
CX387	24100104	CERAMIC CHIP CK73F 25V 10000PF Z
CX391	24100104	CERAMIC CHIP CK73F 25V 10000PF Z
CX431	24100104	CERAMIC CHIP CK73F 25V 10000PF Z
CX432	24100104	CERAMIC CHIP CK73F 25V 10000PF Z
CX471	24100104	CERAMIC CHIP CK73F 25V 10000PF Z
CX473	24092538	CERAMIC CHIP CK73F 10V 1UF Z
CX511	24100104	CERAMIC CHIP CK73F 25V 10000PF Z
CX521	24100104	CERAMIC CHIP CK73F 25V 10000PF Z
CX531	24100104	CERAMIC CHIP CK73F 25V 10000PF Z
CX552	24105820	CERAMIC CHIP CC73CH 50V 82PF J
CX553	24105270	CERAMIC CHIP CC73CH 50V 27PF J
CX554	24105560	CERAMIC CHIP CC73CH 50V 56PF J
CX555	24100104	CERAMIC CHIP CK73F 25V 10000PF Z
CX562	24105101	CERAMIC CHIP CC73CH 50V 100PF J
CX564	24105330	CERAMIC CHIP CC73CH 50V 33PF J
CX565	24100104	CERAMIC CHIP CK73F 25V 10000PF Z
CX572	24105101	CERAMIC CHIP CC73CH 50V 100PF J
CX574	24105330	CERAMIC CHIP CC73CH 50V 33PF J
CX575	24100104	CERAMIC CHIP CK73F 25V 10000PF Z
CX811	24105330	CERAMIC CHIP CC73CH 50V 33PF J
CX812	24105330	CERAMIC CHIP CC73CH 50V 33PF J
CX821	24105100	CERAMIC CHIP CC73CH 50V 10PF D
CX822	24105100	CERAMIC CHIP CC73CH 50V 10PF D
CX823	24105100	CERAMIC CHIP CC73CH 50V 10PF D
CX824	24105221	CERAMIC CHIP CC73CH 50V 220PF J
CX825	24105221	CERAMIC CHIP CC73CH 50V 220PF J
CX826	24105221	CERAMIC CHIP CC73CH 50V 220PF J
CX827	24105221	CERAMIC CHIP CC73CH 50V 220PF J
CX829	24105221	CERAMIC CHIP CC73CH 50V 220PF J
CX844	24105221	CERAMIC CHIP CC73CH 50V 220PF J
CX845	24105221	CERAMIC CHIP CC73CH 50V 220PF J
CY21	24100104	CERAMIC CHIP CK73F 25V 10000PF Z
CY22	24100104	CERAMIC CHIP CK73F 25V 10000PF Z
CY23	24619158	MENJISSOU TYP 16V220U
CY23	24797100	ELECTROLYTIC CE04G 50V 10UF M
CY24	24100104	CERAMIC CHIP CK73F 25V 10000PF Z
CY25	24100104	CERAMIC CHIP CK73F 25V 10000PF Z
CY26	24100104	CERAMIC CHIP CK73F 25V 10000PF Z
CY27	24092730	CERAMIC CHIP, 16V 0.1UF K
CY28	24092730	CERAMIC CHIP, 16V 0.1UF K
CY29	24092730	CERAMIC CHIP, 16V 0.1UF K
CY32	24619151	MENJISSOU TYP 6.3V470U
CY33	24100104	CERAMIC CHIP CK73F 25V 10000PF Z
CY35	24100104	CERAMIC CHIP CK73F 25V 10000PF Z
CY36	24105120	CERAMIC CHIP CC73CH 50V 12PF J
CY37	24105120	CERAMIC CHIP CC73CH 50V 12PF J
CY38	24105120	CERAMIC CHIP CC73CH 50V 12PF J
CY39	24092463	CERAMIC CHIP CK732B 16V R22UF K
CY40	24109222	CERAMIC CHIP CK73B 50V 2200PF K
CY41	24109103	CERAMIC CHIP CK73B 50V 10000PF K
CY42	24619071	MENJISSOU, 2.2U UWX1H2R2MCR1
CY43	24092463	CERAMIC CHIP CK732B 16V R22UF K
CY44	24619071	MENJISSOU, 2.2U UWX1H2R2MCR1
CY45	24109223	CERAMIC CHIP CK73B 25V 22000PF J
CY105	24105221	CERAMIC CHIP CC73CH 50V 220PF J
CY186	24100104	CERAMIC CHIP CK73F 25V 10000PF Z
CY501	24619157	MENJISSOU TYP 16V100U
CY505	24109103	CERAMIC CHIP CK73B 50V 10000PF K
CY601	24619046	MENJISSOU, 470U UWX1C470MCR1
CY602	24100104	CERAMIC CHIP CK73F 25V 10000PF Z
CY603	24100104	CERAMIC CHIP CK73F 25V 10000PF Z
CY604	24100104	CERAMIC CHIP CK73F 25V 10000PF Z



Location No.	Parts No.	Description
CY605	24100104	CERAMIC CHIP CK73F 25V 100000PF Z
CY606	24100104	CERAMIC CHIP CK73F 25V 100000PF Z
CY613	24105330	CERAMIC CHIP CC73CH 50V 33PF J
CY614	24105820	CERAMIC CHIP CC73CH 50V 82PF J
CY616	24100104	CERAMIC CHIP CK73F 25V 100000PF Z
CY617	24100104	CERAMIC CHIP CK73F 25V 100000PF Z
CY621	24100104	CERAMIC CHIP CK73F 25V 100000PF Z
CY622	24100104	CERAMIC CHIP CK73F 25V 100000PF Z
CY623	24105101	CERAMIC CHIP CC73CH 50V 100PF J
CY624	24105101	CERAMIC CHIP CC73CH 50V 100PF J
CY661	24100104	CERAMIC CHIP CK73F 25V 100000PF Z
CY662	24100104	CERAMIC CHIP CK73F 25V 100000PF Z
CY663	24105101	CERAMIC CHIP CC73CH 50V 100PF J
CY664	24105101	CERAMIC CHIP CC73CH 50V 100PF J
CY813	24092538	CERAMIC CHIP CK73F 10V 1UF Z
CY822	24105330	CERAMIC CHIP CC73CH 50V 33PF J
CY824	24100104	CERAMIC CHIP CK73F 25V 100000PF Z
CY825	24092538	CERAMIC CHIP CK73F 10V 1UF Z
CY826	24105330	CERAMIC CHIP CC73CH 50V 33PF J
CY827	24105330	CERAMIC CHIP CC73CH 50V 33PF J
CY828	24105330	CERAMIC CHIP CC73CH 50V 33PF J
CY829	24105330	CERAMIC CHIP CC73CH 50V 33PF J
CY830	24105330	CERAMIC CHIP CC73CH 50V 33PF J
CY900	24619151	MENJISSOU TYP 6.3V470U
CZ02	24100104	CERAMIC CHIP CK73F 25V 100000PF Z
CZ03	24092730	CERAMIC CHIP, 16V 0.1UF K
CZ04	24105181	CERAMIC CHIP CC73CH 50V 180PF J
CZ05	24105680	CERAMIC CHIP CC73CH 50V 68PF J
CZ06	24105330	CERAMIC CHIP CC73CH 50V 33PF J
CZ08	24100104	CERAMIC CHIP CK73F 25V 100000PF Z
CZ09	24109103	CERAMIC CHIP CK73B 50V 10000PF K
CZ10	24619157	MENJISSOU TYP 16V100U
CZ11	24100104	CERAMIC CHIP CK73F 25V 100000PF Z
CZ12	24105101	CERAMIC CHIP CC73CH 50V 100PF J
CZ13	24105101	CERAMIC CHIP CC73CH 50V 100PF J
CZ14	24105151	CERAMIC CHIP CC73CH 50V 150PF J
CZ27	24092538	CERAMIC CHIP CK73F 10V 1UF Z
CZ28	24109561	CERAMIC CHIP CK73B 50V 560PF K
CZ29	24092538	CERAMIC CHIP CK73F 10V 1UF Z
CZ30	24092730	CERAMIC CHIP, 16V 0.1UF K
CZ31	24092730	CERAMIC CHIP, 16V 0.1UF K
CZ32	24100104	CERAMIC CHIP CK73F 25V 100000PF Z
CZ33	24109102	CERAMIC CHIP CK73B 50V 1000PF K
CZ34	24100104	CERAMIC CHIP CK73F 25V 100000PF Z
CZ35	24619070	MENJISSOU, 1U 50V UWX1H010MCR1
CZ36	24619151	MENJISSOU TYP 6.3V470U
CZ37	24100104	CERAMIC CHIP CK73F 25V 100000PF Z
CZ38	24100104	CERAMIC CHIP CK73F 25V 100000PF Z
CZ39	24100104	CERAMIC CHIP CK73F 25V 100000PF Z
CZ40	24100104	CERAMIC CHIP CK73F 25V 100000PF Z
CZ41	24100104	CERAMIC CHIP CK73F 25V 100000PF Z
CZ42	24100104	CERAMIC CHIP CK73F 25V 100000PF Z
CZ43	24100104	CERAMIC CHIP CK73F 25V 100000PF Z
CZ44	24092730	CERAMIC CHIP, 16V 0.1UF K
CZ45	24100104	CERAMIC CHIP CK73F 25V 100000PF Z
CZ46	24100104	CERAMIC CHIP CK73F 25V 100000PF Z
CZ47	24105820	CERAMIC CHIP CC73CH 50V 82PF J
CZ48	24092730	CERAMIC CHIP, 16V 0.1UF K
CZ49	24092730	CERAMIC CHIP, 16V 0.1UF K
CZ50	24100104	CERAMIC CHIP CK73F 25V 100000PF Z
CZ51	24092730	CERAMIC CHIP, 16V 0.1UF K
CZ52	24092730	CERAMIC CHIP, 16V 0.1UF K
CZ54	24100104	CERAMIC CHIP CK73F 25V 100000PF Z
CZ57	24105181	CERAMIC CHIP CC73CH 50V 180PF J
CZ58	24105560	CERAMIC CHIP CC73CH 50V 56PF J

Location No.	Parts No.	Description
CZ60	24100104	CERAMIC CHIP CK73F 25V 100000PF Z
CZ77	24092730	CERAMIC CHIP, 16V 0.1UF K
CZ96	24105270	CERAMIC CHIP CC73CH 50V 27PF J
CZ101	24092441	CHIP CERA CK732F 16V 1UF Z
CZ102	24619157	MENJISSOU TYP 16V100U
CZ103	24100104	CERAMIC CHIP CK73F 25V 100000PF Z
CZ104	24109103	CERAMIC CHIP CK73B 50V 10000PF K
CZ105	24109103	CERAMIC CHIP CK73B 50V 10000PF K
CZ106	24109103	CERAMIC CHIP CK73B 50V 10000PF K
CZ108	24100104	CERAMIC CHIP CK73F 25V 100000PF Z
CZ109	24105101	CERAMIC CHIP CC73CH 50V 100PF J
CZ111	24109103	CERAMIC CHIP CK73B 50V 10000PF K
CZ112	24105181	CERAMIC CHIP CC73CH 50V 180PF J
CZ113	24109103	CERAMIC CHIP CK73B 50V 10000PF K
CZ114	24109103	CERAMIC CHIP CK73B 50V 10000PF K
CZ115	24105390	CERAMIC CHIP CC73CH 50V 39PF J
CZ116	24105470	CERAMIC CHIP CC73CH 50V 47PF J
CZ117	24105680	CERAMIC CHIP CC73CH 50V 68PF J
CZ800	24105330	CERAMIC CHIP CC73CH 50V 33PF J
CZ802	24105330	CERAMIC CHIP CC73CH 50V 33PF J
CZ804	24105330	CERAMIC CHIP CC73CH 50V 33PF J
CZ805	24105330	CERAMIC CHIP CC73CH 50V 33PF J
CZ806	24105330	CERAMIC CHIP CC73CH 50V 33PF J
CZ809	24105330	CERAMIC CHIP CC73CH 50V 33PF J
CZ810	24105330	CERAMIC CHIP CC73CH 50V 33PF J
CZ811	24105330	CERAMIC CHIP CC73CH 50V 33PF J
CZ812	24105330	CERAMIC CHIP CC73CH 50V 33PF J

**RESISTORS**

R101	24553183	OXIDE RES B 1W 183J
R150	24011101	CHIP, METAL FILM, 1/20W 100 OHM J
R151	24011562	METAL FILM CHIP 1/20W 5.6K J
R152	24011103	CHIP, METAL FILM, 1/20W 10K OHM J
R171	24011103	CHIP, METAL FILM, 1/20W 10K OHM J
R172	24011273	METAL FILM CHIP 1/20W 27K J
R173	24011103	CHIP, METAL FILM, 1/20W 10K OHM J
R174	24011273	METAL FILM CHIP 1/20W 27K J
R201	24011101	CHIP, METAL FILM, 1/20W 100 OHM J
R202	24011471	METAL FILM CHIP 1/20W 470 J
R203	24000445	CHIP JUMPER, 1608TYPE
R204	24000445	CHIP JUMPER, 1608TYPE
R207	24011101	CHIP, METAL FILM, 1/20W 100 OHM J
R208	24011102	CHIP, METAL FILM, 1/20W 1K OHM J
R209	24011102	CHIP, METAL FILM, 1/20W 1K OHM J
R210	24011102	CHIP, METAL FILM, 1/20W 1K OHM J
R212	24011103	CHIP, METAL FILM, 1/20W 10K OHM J
R213	24011123	CHIP, METAL FILM, 1/20W 12K OHM J
R214	24011222	METAL FILM CHIP 1/20W 2.2K J
R215	24011101	CHIP, METAL FILM, 1/20W 100 OHM J
R217	24366103	CARBON FILM, 1/6W 10K OHM J
R218	24367303	CARBON,FILM G SB 1/6W 30K G
R219	24366393	CARBON FILM, 1/6W 39K OHM J
R220	24366473	CARBON FILM, 1/6W 47K OHM J
R227	24367273	CARBON FILM, 1/6W 27K OHM G
R227	24367363	CARBON FILM 1/6W 36K G
R228	24367682	CARBON FILM, 1/6W 6.8K OHM G
R245	24011102	CHIP, METAL FILM, 1/20W 1K OHM J
R303	24321109	OXIDE METAL FILM, 1/2W 1 OHM J
R305	24323688	OXIDE METAL FILM, 2W 0.68 OHM J
R306	24366473	CARBON FILM, 1/6W 47K OHM J
R309	24366154	CARBON FILM, 1/6W 150K OHM J
R310	24366102	CARBON FILM, 1/6W 1K OHM J
R312	24366153	CARBON FILM, 1/6W 15K OHM J
R313	24366153	CARBON FILM, 1/6W 15K OHM J
R314	24011101	CHIP, METAL FILM, 1/20W 100 OHM J

Location No.	Parts No.	Description
R315	24011474	METAL FILM CHIP 1/20W 470K J
R317	24366472	CARBON FILM, 1/6W 4.7K OHM J
R318	24366101	CARBON FILM, 1/6W 100 OHM J
R319	24366101	CARBON FILM, 1/6W 100 OHM J
R320	24366101	CARBON FILM, 1/6W 100 OHM J
R321	24366474	CARBON FILM, 1/6W 470K OHM J
R322	24366394	CARBON FILM, 1/6W 390K OHM J
R323	24366274	CARBON,FILM G SB 1/6W 270K J
R324	24366334	CARBON FILM, 1/6W 330K OHM J
R328	24366202	CARBON FILM, 1/6W 2K OHM J
R329	24366153	CARBON FILM, 1/6W 15K OHM J
R330	24366102	CARBON FILM, 1/6W 1K OHM J
R331	24366184	CARBON FILM, 1/6W 180K OHM J
R336	24383271	OXIDE METAL FILM, 2W 270 OHM J
R342	24011101	CHIP, METAL FILM, 1/20W 100 OHM J
R344	24553102	OXIDE METAL FILM, 1W 1K OHM J
R344	24011222	METAL FILM CHIP 1/20W 2.2K J
R354	24366431	CARBON FILM, 1/6W 430 OHM J
R357	24381100	OXIDE FILM 1/2W 10 J
R358	24383101	OXIDE METAL FILM, 2W 100 OHM J
R359	24366103	CARBON FILM, 1/6W 10K OHM J
R360	24366103	CARBON FILM, 1/6W 10K OHM J
R360	24011223	METAL FILM CHIP 1/20W 22K J
R361	24011183	METAL FILM CHIP 1/20W 18K J
R361	24366102	CARBON FILM, 1/6W 1K OHM J
R361	24011223	METAL FILM CHIP 1/20W 22K J
R362	24366103	CARBON FILM, 1/6W 10K OHM J
R362	24011223	METAL FILM CHIP 1/20W 22K J
R363	24366103	CARBON FILM, 1/6W 10K OHM J
R363	24011472	METAL FILM CHIP 1/20W 4.7K J
R364	24366332	CARBON FILM, 1/6W 3.3K OHM J
R365	24366681	CARBON FILM, 1/6W 680 OHM J
R366	24366471	CARBON FILM, 1/6W 470 OHM J
R367	24366472	CARBON FILM, 1/6W 4.7K OHM J
R368	24366333	CARBON FILM, 1/6W 33K OHM J
R369	24366433	CARBON,FILM G SB 1/6W 43K J
R371	24366562	CARBON FILM, 1/6W 5.6K OHM J
R372	24366392	CARBON FILM, 1/6W 3.9K OHM J
R373	24366182	CARBON FILM, 1/6W 1.8K OHM J
R374	24366473	CARBON FILM, 1/6W 47K OHM J
R379	24382103	OXIDE METAL FILM, 1W 10K OHM J
R380	24946226	CARBON CONPOSITION, 1/2W 22M OHM K
R381	24366822	CARBON FILM, 1/6W 8.2K OHM J
R392	24552102	OXIDE METAL FILM, 1/2W 1K OHM J
R394	24366102	CARBON FILM, 1/6W 1K OHM J
R395	24366103	CARBON FILM, 1/6W 10K OHM J
R396	24366103	CARBON FILM, 1/6W 10K OHM J
R397	24366103	CARBON FILM, 1/6W 10K OHM J
R398	24366184	CARBON FILM, 1/6W 180K OHM J
R400	24946561	CARBON COMPOSITION GF 1/2W 560 K
R401	24011361	METAL FILM CHIP 1/20W 360 J
R402	24011103	CHIP, METAL FILM, 1/20W 10K OHM J
R403	24011272	METAL FILM CHIP 1/20W 2.7K J
R405	24553682	OXIDE METAL FILM, 1W 6.8K OHM J
R409	24011102	CHIP, METAL FILM, 1/20W 1K OHM J
R411	24366180	CARBON RES G 1/6W 180J
R412	24323228	METAL FILM, 2W 0.22 OHM J
R413	24011182	METAL FILM CHIP 1/20W 1.8K J
R415	24383271	OXIDE METAL FILM, 2W 270 OHM J
R416	24383820	CAPACITOR, OXIDE FILM 2W 82. J
R417	24366182	CARBON FILM, 1/6W 1.8K OHM J
R418	24366182	CARBON FILM, 1/6W 1.8K OHM J
R422	24011472	METAL FILM CHIP 1/20W 4.7K J
R423	24011103	CHIP, METAL FILM, 1/20W 10K OHM J
R424	24321229	OXIDE METAL FILM, 1/2W 2.2 OHM J

Location No.	Parts No.	Description
R424	24011272	METAL FILM CHIP 1/20W 2.7K J
R425	24011102	CHIP, METAL FILM, 1/20W 1K OHM J
R426	24381363	OXIDE FILM 1/2W 36K J
R433	24366101	CARBON FILM, 1/6W 100 OHM J
R435	24327224	METAL FILM, 1/4W 220K OHM F
R438	24552152	OXIDE METAL FILM, 1/2W 1.5K OHM J
R439	24381100	OXIDE FILM 1/2W 10 J
R441	24383181	OXIDE RES B 2W 181J
R447	24382473	OXIDE METAL FILM, 1W 47K OHM J
R448	24321338	OXIDE METAL FILM, 1/2W 0.33 OHM J
R452	24061546	VARIABLE METAL FILM 1W 100 M
R461	24366183	CARBON FILM, 1/6W 18K OHM J
R462	24367333	CARBON FILM, 1/6W 33K OHM G
△ R467	24000524	METAL FILM 1/4W 4.3K F
△ R468	24000632	METAL FILM 1/4W 9.1K F
R470	24323518	OXIDE METAL FILM, 2W 0.51 OHM J
R471	24381301	OXIDE METAL FILM, 1/2W 300 OHM J
R472	24554270	OXIDE RES B 2W 270J
R473	24000221	METAL FILM, 1/4W 20K OHM F
R474	24366822	CARBON FILM, 1/6W 8.2K OHM J
R475	24366912	CARBON FILM, 1/6W 9.1K OHM J
R476	24000221	METAL FILM, 1/4W 20K OHM F
R477	24366102	CARBON FILM, 1/6W 1K OHM J
R478	24338688	METAL FILM 1W R68 J
R479	24381131	OXIDE METAL FILM, 1/2W 130 OHM J
R480	24366472	CARBON FILM, 1/6W 4.7K OHM J
R481	24366103	CARBON FILM, 1/6W 10K OHM J
R482	24366182	CARBON FILM, 1/6W 1.8K OHM J
R483	24011223	METAL FILM CHIP 1/20W 22K J
R484	24366223	CARBON FILM, 1/6W 22K OHM J
R485	24366223	CARBON FILM, 1/6W 22K OHM J
R485	24011472	METAL FILM CHIP 1/20W 4.7K J
R486	24011622	METAL FILM CHIP 1/20W 6.2K J
R487	24011474	METAL FILM CHIP 1/20W 470K J
R488	24011154	METAL FILM CHIP 1/20W 150K J
R491	24366122	CARBON FILM, 1/6W 1.2K OHM J
R492	24366122	CARBON FILM, 1/6W 1.2K OHM J
R493	24366123	CARBON FILM, 1/6W 12K OHM J
R494	24366184	CARBON FILM, 1/6W 180K OHM J
R496	24382104	OXIDE METAL FILM, 1W 100K OHM J
R499	24322109	METAL FILM, 1W 1 OHM J
R501	24011303	METAL FILM CHIP 1/20W 30K J
R503	24011103	CHIP, METAL FILM, 1/20W 10K OHM J
R505	24011152	CHIP, METAL FILM, 1/20W 1.5K OHM J
R506	24011272	METAL FILM CHIP 1/20W 2.7K J
R508	24011102	CHIP, METAL FILM, 1/20W 1K OHM J
R509	24011102	CHIP, METAL FILM, 1/20W 1K OHM J
R510	24011471	METAL FILM CHIP 1/20W 470 J
R511	24011103	CHIP, METAL FILM, 1/20W 10K OHM J
R512	24011103	CHIP, METAL FILM, 1/20W 10K OHM J
R513	24011104	CHIP, METAL FILM, 1/20W 100K OHM J
R514	24011103	CHIP, METAL FILM, 1/20W 10K OHM J
R515	24011103	CHIP, METAL FILM, 1/20W 10K OHM J
R520	24011101	CHIP, METAL FILM, 1/20W 100 OHM J
R521	24011101	CHIP, METAL FILM, 1/20W 100 OHM J
R525	24011752	METAL FILM CHIP 1/20W 7.5K J
R526	24011101	CHIP, METAL FILM, 1/20W 100 OHM J
R530	24011103	CHIP, METAL FILM, 1/20W 10K OHM J
R531	24011103	CHIP, METAL FILM, 1/20W 10K OHM J
R532	24011103	CHIP, METAL FILM, 1/20W 10K OHM J
R543	24011680	METAL FILM CHIP 1/20W 68 J
R548	24011680	METAL FILM CHIP 1/20W 68 J
R552	24011101	CHIP, METAL FILM, 1/20W 100 OHM J
R553	24011680	METAL FILM CHIP 1/20W 68 J
R560	24011103	CHIP, METAL FILM, 1/20W 10K OHM J

Location No.	Parts No.	Description
R561	24552271	OXIDE METAL FILM, 1/2W 270 OHM J
R562	24011103	CHIP, METAL FILM, 1/20W 10K OHM J
R563	24011102	CHIP, METAL FILM, 1/20W 1K OHM J
R564	24011102	CHIP, METAL FILM, 1/20W 1K OHM J
R565	24011102	CHIP, METAL FILM, 1/20W 1K OHM J
R566	24011101	CHIP, METAL FILM, 1/20W 100 OHM J
R567	24011102	CHIP, METAL FILM, 1/20W 1K OHM J
R568	24011101	CHIP, METAL FILM, 1/20W 100 OHM J
R571	24011101	CHIP, METAL FILM, 1/20W 100 OHM J
R572	24000445	CHIP JUMPER, 1608TYPE
R573	24000445	CHIP JUMPER, 1608TYPE
R610	24871222	CHIP, METAL FILM, 1/8W 2.2K OHM J
R611	24871222	CHIP, METAL FILM, 1/8W 2.2K OHM J
R612	24011103	CHIP, METAL FILM, 1/20W 10K OHM J
R613	24871222	CHIP, METAL FILM, 1/8W 2.2K OHM J
R661	24011103	CHIP, METAL FILM, 1/20W 10K OHM J
R662	24011103	CHIP, METAL FILM, 1/20W 10K OHM J
R663	24011272	METAL FILM CHIP 1/20W 2.7K J
R664	24011272	METAL FILM CHIP 1/20W 2.7K J
R666	24011102	CHIP, METAL FILM, 1/20W 1K OHM J
R667	24011822	METAL FILM CHIP 1/20W 8.2K J
R668	24011223	METAL FILM CHIP 1/20W 22K J
R669	24011223	METAL FILM CHIP 1/20W 22K J
R676	24366229	CARBON FILM, 1/6W 2.2 OHM J
R677	24366229	CARBON FILM, 1/6W 2.2 OHM J
R680	24011473	METAL FILM CHIP 1/20W 47K J
R681	24011103	CHIP, METAL FILM, 1/20W 10K OHM J
R682	24011104	CHIP, METAL FILM, 1/20W 100K OHM J
R683	24011333	METAL FILM CHIP 1/20W 33K J
R686	24366229	CARBON FILM, 1/6W 2.2 OHM J
R693	24011102	CHIP, METAL FILM, 1/20W 1K OHM J
R698	24011102	CHIP, METAL FILM, 1/20W 1K OHM J
R699	24011103	CHIP, METAL FILM, 1/20W 10K OHM J
R702	24552221	OXIDE METAL FILM, 1/2W 220 OHM J
R709	24366563	CARBON FILM, 1/6W 56K OHM J
R713	24366393	CARBON FILM, 1/6W 39K OHM J
R715	24366273	CARBON FILM, 1/6W 27K OHM J
R716	24366273	CARBON FILM, 1/6W 27K OHM J
R717	24366333	CARBON FILM, 1/6W 33K OHM J
R718	24366222	CARBON FILM, 1/6W 2.2K OHM J
R719	24366101	CARBON FILM, 1/6W 100 OHM J
R720	24366102	CARBON FILM, 1/6W 1K OHM J
R721	24366101	CARBON FILM, 1/6W 100 OHM J
R722	24552471	OXIDE METAL FILM, 1/2W 470 OHM J
R723	24366101	CARBON FILM, 1/6W 100 OHM J
R724	24366151	CARBON FILM, 1/6W 150 OHM J
R725	24366182	CARBON FILM, 1/6W 1.8K OHM J
R730	24552100	OXIDE METAL FILM, 1/2W 10 OHM J
R731	24552331	OXIDE METAL FILM, 1/2W 330 OHM J
R732	24366330	CARBON FILM, 1/6W 33 OHM J
R733	24366683	CARBON FILM, 1/6W 68K OHM J
R734	24366330	CARBON FILM, 1/6W 33 OHM J
R735	24366683	CARBON FILM, 1/6W 68K OHM J
R736	24553470	METAL OXIDE FILM B 1W 47 J
R737	24366681	CARBON FILM, 1/6W 680 OHM J
R738	24366102	CARBON FILM, 1/6W 1K OHM J
R739	24366681	CARBON FILM, 1/6W 680 OHM J
R740	24553470	METAL OXIDE FILM B 1W 47 J
R741	24322229	METAL FILM 1W 2R2 J
R742	24322229	METAL FILM 1W 2R2 J
R743	24554181	OXIDE FILM 2W 180 J
R744	24366122	CARBON FILM, 1/6W 1.2K OHM J
R745	24366122	CARBON FILM, 1/6W 1.2K OHM J
R808	24019477	THERMISTOR, PTC THERMISTOR AC140V 1R5 M

Location No.	Parts No.	Description
R810	24045007	CEMENT RES G 20W 1R2J
R818	24366102	CARBON FILM, 1/6W 1K OHM J
R819	24366103	CARBON FILM, 1/6W 10K OHM J
R834	24366102	CARBON FILM, 1/6W 1K OHM J
R835	24366820	CARBON FILM, 1/6W 82 OHM J
R847	24011471	METAL FILM CHIP 1/20W 470 J
R848	24011820	METAL FILM CHIP 1/20W 82 J
R849	24011331	METAL FILM CHIP 1/20W 330 J
R861	24382153	OXIDE FILM 1W 15K J
R862	24552330	OXIDE METAL FILM, 1/2W 33 OHM J
R864	24552102	OXIDE METAL FILM, 1/2W 1K OHM J
R865	24552221	OXIDE METAL FILM, 1/2W 220 OHM J
R867	24000639	METAL FILM, 1/4W 22K OHM F
R868	24552560	OXIDE METAL FILM, 1/2W 56 OHM J
R870	24381151	OXIDE FILM 1/2W 150 J
R871	24381101	OXIDE FILM 1/2W 100 J
R872	24382563	OXIDE FILM 1W 56K J
R883	24381682	OXIDE METAL FILM, 1/2W 6.8K OHM J
R884	24366102	CARBON FILM, 1/6W 1K OHM J
R891	24366152	CARBON FILM, 1/6W 1.5K OHM J
R899	24002000	CARBON COMPOSITION GE 1/2W 3R9M K
R901	24946561	CARBON COMPOSITION GF 1/2W 560 K
R902	24946561	CARBON COMPOSITION GF 1/2W 560 K
R903	24946561	CARBON COMPOSITION GF 1/2W 560 K
R904	24366472	CARBON FILM, 1/6W 4.7K OHM J
R905	24366150	CARBON FILM, 1/6W 15 OHM J
R906	24366103	CARBON FILM, 1/6W 10K OHM J
R912	24366102	CARBON FILM, 1/6W 1K OHM J
R914	24366151	CARBON FILM, 1/6W 150 OHM J
R915	24366470	CARBON FILM, 1/6W 47 OHM J
R916	24366150	CARBON FILM, 1/6W 15 OHM J
R917	24366431	CARBON FILM, 1/6W 430 OHM J
R918	24366240	CARBON FILM, 1/6W 24 OHM J
R919	24366102	CARBON FILM, 1/6W 1K OHM J
R920	24339159	METAL FILM 2W 1R5 J (36HFX71)
R920	24000879	FRN98Z3D519 (32HFX71)
R921	24366151	CARBON FILM, 1/6W 150 OHM J
R922	24366470	CARBON FILM, 1/6W 47 OHM J
R924	24366220	CARBON FILM, 1/6W 22 OHM J
R925	24366431	CARBON FILM, 1/6W 430 OHM J
R926	24366102	CARBON FILM, 1/6W 1K OHM J
R928	24366151	CARBON FILM, 1/6W 150 OHM J
R929	24366470	CARBON FILM, 1/6W 47 OHM J
R930	24366180	CARBON RES G 1/6W 180J
R932	24366332	CARBON F1LM, 1/6W 3.3K OHM J
R933	24366750	CARBON FILM, 1/6W 75 OHM J
R934	24366391	CARBON FILM, 1/6W 390 OHM J
R935	24366122	CARBON FILM, 1/6W 1.2K OHM J
R936	24366750	CARBON FILM, 1/6W 75 OHM J
R937	24366431	CARBON FILM, 1/6W 430 OHM J
R939	24366470	CARBON FILM, 1/6W 47 OHM J
R942	24366392	CARBON FILM, 1/6W 3.9K OHM J
R943	24366392	CARBON FILM, 1/6W 3.9K OHM J
R944	24366392	CARBON FILM, 1/6W 3.9K OHM J
R945	24366150	CARBON FILM, 1/6W 15 OHM J
R946	24366150	CARBON FILM, 1/6W 15 OHM J
R947	24366391	CARBON FILM, 1/6W 390 OHM J
R948	24366822	CARBON FILM, 1/6W 8.2K OHM J
R949	24366471	CARBON F1LM, 1/6W 470 OHM J
R952	24366622	CARBON FILM, 1/6W 6.2K OHM J
R953	24366622	CARBON FILM, 1/6W 6.2K OHM J
R954	24366622	CARBON FILM, 1/6W 6.2K OHM J
R960	24383153	OXIDE METAL FILM, 2W 15K OHM J
R961	24383153	OXIDE METAL FILM, 2W 15K OHM J
R962	24383153	OXIDE METAL FILM, 2W 15K OHM J

Location No.	Parts No.	Description
R963	24383153	OXIDE METAL FILM, 2W 15K OHM J
R964	24383153	OXIDE METAL FILM, 2W 15K OHM J
R965	24383153	OXIDE METAL FILM, 2W 15K OHM J
R967	24366682	CARBON FILM, 1/6W 6.8K OHM J
R968	24366332	CARBON F1LM, 1/6W 3.3K OHM J
R969	24366122	CARBON FILM, 1/6W 1.2K OHM J
R970	24366472	CARBON FILM, 1/6W 4.7K OHM J
R971	24366332	CARBON F1LM, 1/6W 3.3K OHM J
R972	24366102	CARBON FILM, 1/6W 1K OHM J
R973	24366103	CARBON FILM, 1/6W 10K OHM J
R974	24366103	CARBON FILM, 1/6W 10K OHM J
R975	24366102	CARBON FILM, 1/6W 1K OHM J
R976	24366102	CARBON FILM, 1/6W 1K OHM J
R977	24366561	CARBON FILM, 1/6W 560 OHM J
R978	24383153	OXIDE METAL FILM, 2W 15K OHM J
R979	24383153	OXIDE METAL FILM, 2W 15K OHM J
R980	24366471	CARBON F1LM, 1/6W 470 OHM J
R981	24366471	CARBON F1LM, 1/6W 470 OHM J
R982	24366682	CARBON FILM, 1/6W 6.8K OHM J
R983	24366222	CARBON FILM, 1/6W 2.2K OHM J
R984	24367821	CARBON,FILM SB 1/6W 820. G
R985	24367471	CARBON FILM, 1/6W 470 OHM G
R986	24367681	CARBON FILM, 1/6W 680 OHM G
R987	24367681	CARBON FILM, 1/6W 680 OHM G
R988	24367472	CARBON FOLM, 1/6W 4.7K OHM G
R989	24367472	CARBON FOLM, 1/6W 4.7K OHM G
R990	24366561	CARBON FILM, 1/6W 560 OHM J
R991	24367391	CARBON FILM, 1/6W 390 OHM G
R992	24366150	CARBON FILM, 1/6W 15 OHM J
R993	24383153	OXIDE METAL FILM, 2W 15K OHM J
R994	24383153	OXIDE METAL FILM, 2W 15K OHM J
R995	24383153	OXIDE METAL FILM, 2W 15K OHM J
R996	24383153	OXIDE METAL FILM, 2W 15K OHM J
R997	24366272	CARBON FILM, 1/6W 2.7K OHM J
R998	24366102	CARBON FILM, 1/6W 1K OHM J
R999	24366102	CARBON FILM, 1/6W 1K OHM J
R2020	24011101	CHIP, METAL FILM, 1/20W 100 OHM J
R2060	24011102	CHIP, METAL FILM, 1/20W 1K OHM J
R2061	24011101	CHIP, METAL FILM, 1/20W 100 OHM J
R2105	24011101	CHIP, METAL FILM, 1/20W 100 OHM J
R2106	24011101	CHIP, METAL FILM, 1/20W 100 OHM J
R2107	24011101	CHIP, METAL FILM, 1/20W 100 OHM J
R2108	24011103	CHIP, METAL FILM, 1/20W 10K OHM J
R2109	24011103	CHIP, METAL FILM, 1/20W 10K OHM J
R2110	24011103	CHIP, METAL FILM, 1/20W 10K OHM J
R2149	24871681	CHIP, METAL FILM, 1/8W 680 OHM J
R2150	24871681	CHIP, METAL FILM, 1/8W 680 OHM J
R2151	24871681	CHIP, METAL FILM, 1/8W 680 OHM J
R2152	24011101	CHIP, METAL FILM, 1/20W 100 OHM J
R2153	24011101	CHIP, METAL FILM, 1/20W 100 OHM J
R2154	24011101	CHIP, METAL FILM, 1/20W 100 OHM J
R3105	24011102	CHIP, METAL FILM, 1/20W 1K OHM J
R3106	24011102	CHIP, METAL FILM, 1/20W 1K OHM J
R3110	24011224	METAL FILM CHIP 1/20W 220K J
R4201	24011103	CHIP, METAL FILM, 1/20W 10K OHM J
R4202	24011102	CHIP, METAL FILM, 1/20W 1K OHM J
R4203	24011561	METAL FILM CHIP 1/20W 560 J
R4204	24011152	CHIP, METAL FILM, 1/20W 1.5K OHM J
R4228	24011682	METAL FILM CHIP 1/20W 6.8K J
R4310	24366183	CARBON FILM, 1/6W 18K OHM J
R4311	24366563	CARBON FILM, 1/6W 56K OHM J
R4385	24366822	CARBON FILM, 1/6W 8.2K OHM J
R4386	24366331	CARBON FILM, 1/6W 330 OHM J
R4402	24011105	CHIP, METAL FILM, 1/20W 1M OHM J
R4406	24011622	METAL FILM CHIP 1/20W 6.2K J

Location No.	Parts No.	Description
R4407	24011361	METAL FILM CHIP 1/20W 360 J
R4410	24011103	CHIP, METAL FILM, 1/20W 10K OHM J
R4416	24011471	METAL FILM CHIP 1/20W 470 J
R4417	24011471	METAL FILM CHIP 1/20W 470 J
R4422	24011101	CHIP, METAL FILM, 1/20W 100 OHM J
R4425	24552471	OXIDE METAL FILM, 1/2W 470 OHM J
R4460	24366102	CARBON FILM, 1/6W 1K OHM J
R4461	24366102	CARBON FILM, 1/6W 1K OHM J
R4462	24366133	CARBON FILM, 1/6W 13K OHM J
R4463	24366682	CARBON FILM, 1/6W 6.8K OHM J
R4463	24011471	METAL FILM CHIP 1/20W 470 J
R4464	24011302	METAL FILM CHIP 1/20W 3K J
R4466	24366103	CARBON FILM, 1/6W 10K OHM J
R4467	24366103	CARBON FILM, 1/6W 10K OHM J
R4468	24366562	CARBON FILM, 1/6W 5.6K OHM J
R4469	24366102	CARBON FILM, 1/6W 1K OHM J
R4470	24366393	CARBON FILM, 1/6W 39K OHM J
R4471	24011103	CHIP, METAL FILM, 1/20W 10K OHM J
R4472	24011223	METAL FILM CHIP 1/20W 22K J
R4560	24011103	CHIP, METAL FILM, 1/20W 10K OHM J
R4561	24011103	CHIP, METAL FILM, 1/20W 10K OHM J
R4761	24366102	CARBON FILM, 1/6W 1K OHM J
R4762	24366104	CARBON FILM, 1/6W 100K OHM J
R4763	24366472	CARBON FILM, 1/6W 4.7K OHM J
R4764	24366104	CARBON FILM, 1/6W 100K OHM J
R4765	24366221	CARBON FILM, 1/6W 220 OHM J
R4766	24366202	CARBON FILM, 1/6W 2K OHM J
R4767	24003984	METAL RES S 1/4W 102J
R4768	24366622	CARBON FILM, 1/6W 6.2K OHM J
R4816	24366471	CARBON F1LM, 1/6W 470 OHM J
R4818	24366681	CARBON FILM, 1/6W 680 OHM J
R4819	24366102	CARBON FILM, 1/6W 1K OHM J
R4820	24011103	CHIP, METAL FILM, 1/20W 10K OHM J
R5020	24011101	CHIP, METAL FILM, 1/20W 100 OHM J
R5030	24011101	CHIP, METAL FILM, 1/20W 100 OHM J
R9701	24366821	CARBON FILM, 1/6W 820 OHM J
RA01	24011102	CHIP, METAL FILM, 1/20W 1K OHM J
RA02	24011101	CHIP, METAL FILM, 1/20W 100 OHM J
RA03	24011101	CHIP, METAL FILM, 1/20W 100 OHM J
RA04	24011101	CHIP, METAL FILM, 1/20W 100 OHM J
RA05	24011101	CHIP, METAL FILM, 1/20W 100 OHM J
RA06	24011101	CHIP, METAL FILM, 1/20W 100 OHM J
RA07	24011101	CHIP, METAL FILM, 1/20W 100 OHM J
RA09	24011102	CHIP, METAL FILM, 1/20W 1K OHM J
RA10	24011101	CHIP, METAL FILM, 1/20W 10K OHM J
RA12	24011102	CHIP, METAL FILM, 1/20W 1K OHM J
RA13	24011102	CHIP, METAL FILM, 1/20W 1K OHM J
RA15	24011102	CHIP, METAL FILM, 1/20W 1K OHM J
RA16	24011102	CHIP, METAL FILM, 1/20W 1K OHM J
RA17	24011101	CHIP, METAL FILM, 1/20W 100 OHM J
RA21	24011102	CHIP, METAL FILM, 1/20W 1K OHM J
RA22	24011682	METAL FILM CHIP 1/20W 6.8K J
RA23	24011102	CHIP, METAL FILM, 1/20W 1K OHM J
RA26	24011333	METAL FILM CHIP 1/20W 33K J
RA28	24011101	CHIP, METAL FILM, 1/20W 100 OHM J
RA30	24011101	CHIP, METAL FILM, 1/20W 100 OHM J
RA32	24011682	METAL FILM CHIP 1/20W 6.8K J
RA33	24011103	CHIP, METAL FILM, 1/20W 10K OHM J
RA35	24011152	CHIP, METAL FILM, 1/20W 1.5K OHM J
RA36	24011332	METAL FILM CHIP 1/20W 3.3K J
RA37	24011101	CHIP, METAL FILM, 1/20W 100 OHM J
RA38	24872101	CHIP, METAL FILM, 1/16W 100 OHM J
RA39	24011101	CHIP, METAL FILM, 1/20W 100 OHM J
RA40	24011101	CHIP, METAL FILM, 1/20W 100 OHM J
RA41	24011332	METAL FILM CHIP 1/20W 3.3K J

Location No.	Parts No.	Description
RA42	24011151	CHIP, METAL FILM, 1/20W 150 OHM J
RA43	24011102	CHIP, METAL FILM, 1/20W 1K OHM J
RA44	24011102	CHIP, METAL FILM, 1/20W 1K OHM J
RA45	24011102	CHIP, METAL FILM, 1/20W 1K OHM J
RA46	24011102	CHIP, METAL FILM, 1/20W 1K OHM J
RA49	24011102	CHIP, METAL FILM, 1/20W 1K OHM J
RA51	24011101	CHIP, METAL FILM, 1/20W 100 OHM J
RA52	24011103	CHIP, METAL FILM, 1/20W 10K OHM J
RA54	24011332	METAL FILM CHIP 1/20W 3.3K J
RA55	24011102	CHIP, METAL FILM, 1/20W 1K OHM J
RA59	24011101	CHIP, METAL FILM, 1/20W 100 OHM J
RA60	24011101	CHIP, METAL FILM, 1/20W 100 OHM J
RA71	24366273	CARBON FILM, 1/6W 27K OHM J
RA72	24011332	METAL FILM CHIP 1/20W 3.3K J
RA72	24366153	CARBON FILM, 1/6W 15K OHM J
RA73	24011471	METAL FILM CHIP 1/20W 470 J
RA73	24366822	CARBON FILM, 1/6W 8.2K OHM J
RA74	24011153	CHIP, METAL FILM, 1/20W 15K OHM J
RA75	24011153	CHIP, METAL FILM, 1/20W 15K OHM J
RA76	24011103	CHIP, METAL FILM, 1/20W 10K OHM J
RA76	24366822	CARBON FILM, 1/6W 8.2K OHM J
RA77	24011103	CHIP, METAL FILM, 1/20W 10K OHM J
RA77	24366153	CARBON FILM, 1/6W 15K OHM J
RA78	24011333	METAL FILM CHIP 1/20W 33K J
RA78	24366273	CARBON FILM, 1/6W 27K OHM J
RA79	24011333	METAL FILM CHIP 1/20W 33K J
RA80	24011101	CHIP, METAL FILM, 1/20W 100 OHM J
RA81	24011473	METAL FILM CHIP 1/20W 47K J
RA021	24011101	CHIP, METAL FILM, 1/20W 100 OHM J
RA031	24011101	CHIP, METAL FILM, 1/20W 100 OHM J
RA116	24011103	CHIP, METAL FILM, 1/20W 10K OHM J
RA161	24011103	CHIP, METAL FILM, 1/20W 10K OHM J
RA191	24011101	CHIP, METAL FILM, 1/20W 100 OHM J
RA192	24011101	CHIP, METAL FILM, 1/20W 100 OHM J
RA195	24011101	CHIP, METAL FILM, 1/20W 100 OHM J
RA196	24011472	METAL FILM CHIP 1/20W 4.7K J
RA197	24011472	METAL FILM CHIP 1/20W 4.7K J
RA198	24011472	METAL FILM CHIP 1/20W 4.7K J
RA199	24011472	METAL FILM CHIP 1/20W 4.7K J
RA210	24011102	CHIP, METAL FILM, 1/20W 1K OHM J
RA211	24011102	CHIP, METAL FILM, 1/20W 1K OHM J
RA212	24011102	CHIP, METAL FILM, 1/20W 1K OHM J
RA221	24366153	CARBON FILM, 1/6W 15K OHM J
RA361	24011102	CHIP, METAL FILM, 1/20W 1K OHM J
RA401	24011471	METAL FILM CHIP 1/20W 470 J
RA431	24011103	CHIP, METAL FILM, 1/20W 10K OHM J
RA703	24011102	CHIP, METAL FILM, 1/20W 1K OHM J
RA705	24011103	CHIP, METAL FILM, 1/20W 10K OHM J
RA708	24011101	CHIP, METAL FILM, 1/20W 100 OHM J
RB03	24011330	METAL FILM CHIP 1/20W 33 J
RB05	24011102	CHIP, METAL FILM, 1/20W 1K OHM J
RB11	24366271	CARBON FILM, 1/6W 270 OHM J
RB12	24366103	CARBON FILM, 1/6W 10K OHM J
RB13	24366470	CARBON FILM, 1/6W 47 OHM J
RB14	24011153	CHIP, METAL FILM, 1/20W 15K OHM J
RB15	24011153	CHIP, METAL FILM, 1/20W 15K OHM J
RB16	24011471	METAL FILM CHIP 1/20W 470 J
RB17	24011332	METAL FILM CHIP 1/20W 3.3K J
RB28	24011102	CHIP, METAL FILM, 1/20W 1K OHM J
RB29	24011472	METAL FILM CHIP 1/20W 4.7K J
RB30	24366103	CARBON FILM, 1/6W 10K OHM J
RB30	24011472	METAL FILM CHIP 1/20W 4.7K J
RB31	24011101	CHIP, METAL FILM, 1/20W 100 OHM J
RB32	24011274	METAL FILM CHIP 1/20W 270K J
RB33	24011123	CHIP, METAL FILM, 1/20W 12K OHM J

Location No.	Parts No.	Description
RB34	24011392	METAL FILM CHIP 1/20W 3.9K J
RB35	24011103	CHIP, METAL FILM, 1/20W 10K OHM J
RB37	24011302	METAL FILM CHIP 1/20W 3K J
RB38	24011103	CHIP, METAL FILM, 1/20W 10K OHM J
RB39	24011183	METAL FILM CHIP 1/20W 18K J
RB41	24366123	CARBON FILM, 1/6W 12K OHM J
RB41	24011151	CHIP, METAL FILM, 1/20W 150 OHM J
RB42	24366153	CARBON FILM, 1/6W 15K OHM J
RB46	24011103	CHIP, METAL FILM, 1/20W 10K OHM J
RB49	24011331	METAL FILM CHIP 1/20W 330 J
RB90	24011392	METAL FILM CHIP 1/20W 3.9K J
RB91	24011473	METAL FILM CHIP 1/20W 47K J
RB92	24011271	METAL FILM CHIP 1/20W 270 J
RB93	24011271	METAL FILM CHIP 1/20W 270 J
RB94	24011222	METAL FILM CHIP 1/20W 2.2K J
RB95	24011222	METAL FILM CHIP 1/20W 2.2K J
RB96	24011273	METAL FILM CHIP 1/20W 27K J
RB97	24011273	METAL FILM CHIP 1/20W 27K J
RB98	24011102	CHIP, METAL FILM, 1/20W 1K OHM J
RB031	24011330	METAL FILM CHIP 1/20W 33 J
RB032	24011330	METAL FILM CHIP 1/20W 33 J
RB033	24011103	CHIP, METAL FILM, 1/20W 10K OHM J
RB051	24011102	CHIP, METAL FILM, 1/20W 1K OHM J
RB052	24011332	METAL FILM CHIP 1/20W 3.3K J
RB511	24011102	CHIP, METAL FILM, 1/20W 1K OHM J
RB512	24011100	CHIP, METAL FILM, 1/20W 10 OHM J
RB551	24011102	CHIP, METAL FILM, 1/20W 1K OHM J
RB552	24011102	CHIP, METAL FILM, 1/20W 1K OHM J
RB553	24011332	METAL FILM CHIP 1/20W 3.3K J
RD02	24366101	CARBON FILM, 1/6W 100 OHM J
RD03	24366105	CARBON FILM, 1/6W 1M OHM J
RD04	24366221	CARBON FILM, 1/6W 220 OHM J
RD05	24366101	CARBON FILM, 1/6W 100 OHM J
RD07	24366101	CARBON FILM, 1/6W 100 OHM J
RD23	24366101	CARBON FILM, 1/6W 100 OHM J
RD29	24366101	CARBON FILM, 1/6W 100 OHM J
RD41	24366123	CARBON FILM, 1/6W 12K OHM J
RD42	24366223	CARBON FILM, 1/6W 22K OHM J
RD43	24366182	CARBON FILM, 1/6W 1.8K OHM J
RD44	24366123	CARBON FILM, 1/6W 12K OHM J
RD45	24366333	CARBON FILM, 1/6W 33K OHM J
RD46	24366272	CARBON FILM, 1/6W 2.7K OHM J
RD47	24366104	CARBON FILM, 1/6W 100K OHM J
RD48	24366153	CARBON FILM, 1/6W 15K OHM J
RD49	24366562	CARBON FILM, 1/6W 5.6K OHM J
RD60	24366222	CARBON FILM, 1/6W 2.2K OHM J
RD61	24366682	CARBON FILM, 1/6W 6.8K OHM J
RD62	24366109	CARBON FILM, 1/6W 1 OHM J
RD72	24366103	CARBON FILM, 1/6W 10K OHM J
RD73	24366101	CARBON FILM, 1/6W 100 OHM J
RD74	24366101	CARBON FILM, 1/6W 100 OHM J
RD75	24366473	CARBON FILM, 1/6W 47K OHM J
RD76	24366122	CARBON FILM, 1/6W 1.2K OHM J
RD77	24366473	CARBON FILM, 1/6W 47K OHM J
RD78	24366122	CARBON FILM, 1/6W 1.2K OHM J
RD101	24366393	CARBON FILM, 1/6W 39K OHM J
RD102	24366393	CARBON FILM, 1/6W 39K OHM J
RD104	24366101	CARBON FILM, 1/6W 100 OHM J
RD107	24366101	CARBON FILM, 1/6W 100 OHM J
RD109	24366223	CARBON FILM, 1/6W 22K OHM J
RD110	24366473	CARBON FILM, 1/6W 47K OHM J
RD113	24366101	CARBON FILM, 1/6W 100 OHM J
RD114	24366221	CARBON FILM, 1/6W 220 OHM J
RD115	24366101	CARBON FILM, 1/6W 100 OHM J
RD116	24366101	CARBON FILM, 1/6W 100 OHM J

Location No.	Parts No.	Description
RD117	24366472	CARBON FILM, 1/6W 4.7K OHM J
RD118	24366822	CARBON FILM, 1/6W 8.2K OHM J
RD119	24366822	CARBON FILM, 1/6W 8.2K OHM J
RD120	24366472	CARBON FILM, 1/6W 4.7K OHM J
RJ01	24366103	CARBON FILM, 1/6W 10K OHM J
RJ02	24366102	CARBON FILM, 1/6W 1K OHM J
RJ04	24366102	CARBON FILM, 1/6W 1K OHM J
RJ05	24323479	METAL FILM, 2W 4.7 OHM J
RJ06	24366103	CARBON FILM, 1/6W 10K OHM J
RJ24	24000445	CHIP JUMPER, 1608TYPE
RJ25	24000445	CHIP JUMPER, 1608TYPE
RM16	24011101	CHIP, METAL FILM, 1/20W 100 OHM J
RM18	24011102	CHIP, METAL FILM, 1/20W 1K OHM J
RM79	24011472	METAL FILM CHIP 1/20W 4.7K J
RM80	24011103	CHIP, METAL FILM, 1/20W 10K OHM J
RM82	24011473	METAL FILM CHIP 1/20W 47K J
RM83	24011472	METAL FILM CHIP 1/20W 4.7K J
RR31	24011102	CHIP, METAL FILM, 1/20W 1K OHM J
RR90	24011182	METAL FILM CHIP 1/20W 1.8K J
RR91	24011153	CHIP, METAL FILM, 1/20W 15K OHM J
RR92	24011123	CHIP, METAL FILM, 1/20W 12K OHM J
RR93	24011562	METAL FILM CHIP 1/20W 5.6K J
RR94	24011102	CHIP, METAL FILM, 1/20W 1K OHM J
RR95	24011562	METAL FILM CHIP 1/20W 5.6K J
RS02	24011472	METAL FILM CHIP 1/20W 4.7K J
RS04	24011102	CHIP, METAL FILM, 1/20W 1K OHM J
RS06	24011102	CHIP, METAL FILM, 1/20W 1K OHM J
RS07	24011103	CHIP, METAL FILM, 1/20W 10K OHM J
RS08	24011103	CHIP, METAL FILM, 1/20W 10K OHM J
RS09	24011102	CHIP, METAL FILM, 1/20W 1K OHM J
RS10	24011102	CHIP, METAL FILM, 1/20W 1K OHM J
RS12	24011103	CHIP, METAL FILM, 1/20W 10K OHM J
RS21	24011104	CHIP, METAL FILM, 1/20W 100K OHM J
RS22	24011104	CHIP, METAL FILM, 1/20W 100K OHM J
RS25	24011223	METAL FILM CHIP 1/20W 22K J
RS26	24011223	METAL FILM CHIP 1/20W 22K J
RS27	24011471	METAL FILM CHIP 1/20W 470 J
RS28	24011471	METAL FILM CHIP 1/20W 470 J
RS29	24011104	CHIP, METAL FILM, 1/20W 100K OHM J
RS30	24011104	CHIP, METAL FILM, 1/20W 100K OHM J
RS31	24011103	CHIP, METAL FILM, 1/20W 10K OHM J
RS32	24011104	CHIP, METAL FILM, 1/20W 100K OHM J
RS33	24011222	METAL FILM CHIP 1/20W 2.2K J
RS34	24011222	METAL FILM CHIP 1/20W 2.2K J
RS35	24011103	CHIP, METAL FILM, 1/20W 10K OHM J
RS36	24011103	CHIP, METAL FILM, 1/20W 10K OHM J
RS37	24011101	CHIP, METAL FILM, 1/20W 100 OHM J
RS40	24011101	CHIP, METAL FILM, 1/20W 100 OHM J
RS42	24011101	CHIP, METAL FILM, 1/20W 100 OHM J
RS48	24011101	CHIP, METAL FILM, 1/20W 100 OHM J
RS49	24011103	CHIP, METAL FILM, 1/20W 10K OHM J
RS51	24011103	CHIP, METAL FILM, 1/20W 10K OHM J
RS52	24011103	CHIP, METAL FILM, 1/20W 10K OHM J
RS53	24011103	CHIP, METAL FILM, 1/20W 10K OHM J
RS54	24011103	CHIP, METAL FILM, 1/20W 10K OHM J
RS101	24011102	CHIP, METAL FILM, 1/20W 1K OHM J
RS102	24011102	CHIP, METAL FILM, 1/20W 1K OHM J
RS103	24011103	CHIP, METAL FILM, 1/20W 10K OHM J
RS104	24011104	CHIP, METAL FILM, 1/20W 100K OHM J
RS105	24011332	METAL FILM CHIP 1/20W 3.3K J
RS107	24011473	METAL FILM CHIP 1/20W 47K J
RS108	24011473	METAL FILM CHIP 1/20W 47K J
RS109	24011472	METAL FILM CHIP 1/20W 4.7K J
RS110	24011471	METAL FILM CHIP 1/20W 470 J
RS111	24011222	METAL FILM CHIP 1/20W 2.2K J

Location No.	Parts No.	Description
RS112	24011223	METAL FILM CHIP 1/20W 22K J
RS113	24011472	METAL FILM CHIP 1/20W 4.7K J
RS114	24011471	METAL FILM CHIP 1/20W 470 J
RS115	24011222	METAL FILM CHIP 1/20W 2.2K J
RS116	24011273	METAL FILM CHIP 1/20W 27K J
RS120	24366271	CARBON FILM, 1/6W 270 OHM J
RS121	24011103	CHIP, METAL FILM, 1/20W 10K OHM J
RS122	24011103	CHIP, METAL FILM, 1/20W 10K OHM J
RS123	24011473	METAL FILM CHIP 1/20W 47K J
RS124	24011102	CHIP, METAL FILM, 1/20W 1K OHM J
RS125	24011122	CHIP, METAL FILM, 1/20W 1.2K OHM J
RS651	24011101	CHIP, METAL FILM, 1/20W 100 OHM J
RS652	24011101	CHIP, METAL FILM, 1/20W 100 OHM J
RS657	24011103	CHIP, METAL FILM, 1/20W 10K OHM J
RS658	24011103	CHIP, METAL FILM, 1/20W 10K OHM J
RS659	24011103	CHIP, METAL FILM, 1/20W 10K OHM J
RS660	24011103	CHIP, METAL FILM, 1/20W 10K OHM J
RS665	24011103	CHIP, METAL FILM, 1/20W 10K OHM J
RS671	24000445	CHIP JUMPER, 1608TYPE
RS672	24011273	METAL FILM CHIP 1/20W 27K J
RS673	24000445	CHIP JUMPER, 1608TYPE
RS674	24011273	METAL FILM CHIP 1/20W 27K J
RS675	24011223	METAL FILM CHIP 1/20W 22K J
RS676	24011101	CHIP, METAL FILM, 1/20W 100 OHM J
RV01	24011472	METAL FILM CHIP 1/20W 4.7K J
RV03	24011101	CHIP, METAL FILM, 1/20W 100 OHM J
RV04	24011101	CHIP, METAL FILM, 1/20W 100 OHM J
RV11	24011100	CHIP, METAL FILM, 1/20W 10 OHM J
RV12	24011100	CHIP, METAL FILM, 1/20W 10 OHM J
RV13	24011100	CHIP, METAL FILM, 1/20W 10 OHM J
RV15	24011222	METAL FILM CHIP 1/20W 2.2K J
RV17	24366750	CARBON FILM, 1/6W 75 OHM J
RV18	24366750	CARBON FILM, 1/6W 75 OHM J
RV19	24366332	CARBON F1LM, 1/6W 3.3K OHM J
RV24	24011750	METAL FILM CHIP 1/20W 75 J
RV25	24011750	METAL FILM CHIP 1/20W 75 J
RV26	24011750	METAL FILM CHIP 1/20W 75 J
RV30	24011182	METAL FILM CHIP 1/20W 1.8K J
RV31	24011332	METAL FILM CHIP 1/20W 3.3K J
RV56	24011101	CHIP, METAL FILM, 1/20W 100 OHM J
RV63	24011102	CHIP, METAL FILM, 1/20W 1K OHM J
RV64	24011750	METAL FILM CHIP 1/20W 75 J
RV65	24011750	METAL FILM CHIP 1/20W 75 J
RV67	24011750	METAL FILM CHIP 1/20W 75 J
RV72	24011221	METAL FILM CHIP 1/20W 220 J
RV74	24011750	METAL FILM CHIP 1/20W 75 J
RV78	24011103	CHIP, METAL FILM, 1/20W 10K OHM J
RV79	24011101	CHIP, METAL FILM, 1/20W 100 OHM J
RV83	24011332	METAL FILM CHIP 1/20W 3.3K J
RV84	24011750	METAL FILM CHIP 1/20W 75 J
RV89	24011620	METAL FILM CHIP 1/20W 62 J
RV90	24011103	CHIP, METAL FILM, 1/20W 10K OHM J
RV91	24011392	METAL FILM CHIP 1/20W 3.9K J
RV92	24011101	CHIP, METAL FILM, 1/20W 100 OHM J
RV93	24011103	CHIP, METAL FILM, 1/20W 10K OHM J
RV94	24011392	METAL FILM CHIP 1/20W 3.9K J
RV95	24011101	CHIP, METAL FILM, 1/20W 100 OHM J
RV96	24011103	CHIP, METAL FILM, 1/20W 10K OHM J
RV97	24011392	METAL FILM CHIP 1/20W 3.9K J
RV98	24011101	CHIP, METAL FILM, 1/20W 100 OHM J
RV111	24011100	CHIP, METAL FILM, 1/20W 10 OHM J
RV117	24011750	METAL FILM CHIP 1/20W 75 J
RV118	24011750	METAL FILM CHIP 1/20W 75 J
RV119	24011750	METAL FILM CHIP 1/20W 75 J
RV120	24366750	CARBON FILM, 1/6W 75 OHM J

Location No.	Parts No.	Description
RV121	24011100	CHIP, METAL FILM, 1/20W 10 OHM J
RV131	24011100	CHIP, METAL FILM, 1/20W 10 OHM J
RV178	24011152	CHIP, METAL FILM, 1/20W 1.5K OHM J
RV179	24011472	METAL FILM CHIP 1/20W 4.7K J
RV180	24011472	METAL FILM CHIP 1/20W 4.7K J
RV181	24011100	CHIP, METAL FILM, 1/20W 10 OHM J
RV182	24011100	CHIP, METAL FILM, 1/20W 10 OHM J
RV183	24011100	CHIP, METAL FILM, 1/20W 10 OHM J
RV184	24011182	METAL FILM CHIP 1/20W 1.8K J
RV185	24011182	METAL FILM CHIP 1/20W 1.8K J
RV186	24011182	METAL FILM CHIP 1/20W 1.8K J
RV301	24011750	METAL FILM CHIP 1/20W 75 J
RV319	24011332	METAL FILM CHIP 1/20W 3.3K J
RV510	24011102	CHIP, METAL FILM, 1/20W 1K OHM J
RV511	24011472	METAL FILM CHIP 1/20W 4.7K J
RV520	24011472	METAL FILM CHIP 1/20W 4.7K J
RV521	24011472	METAL FILM CHIP 1/20W 4.7K J
RV522	24011472	METAL FILM CHIP 1/20W 4.7K J
RV523	24011101	CHIP, METAL FILM, 1/20W 100 OHM J
RV525	24011101	CHIP, METAL FILM, 1/20W 100 OHM J
RV527	24011101	CHIP, METAL FILM, 1/20W 100 OHM J
RV529	24000445	CHIP JUMPER, 1608TYPE
RV530	24000445	CHIP JUMPER, 1608TYPE
RV531	24000445	CHIP JUMPER, 1608TYPE
RV532	24011101	CHIP, METAL FILM, 1/20W 100 OHM J
RV533	24011101	CHIP, METAL FILM, 1/20W 100 OHM J
RV534	24011101	CHIP, METAL FILM, 1/20W 100 OHM J
RV544	24011103	CHIP, METAL FILM, 1/20W 10K OHM J
RV545	24011103	CHIP, METAL FILM, 1/20W 10K OHM J
RV546	24011103	CHIP, METAL FILM, 1/20W 10K OHM J
RV550	24011472	METAL FILM CHIP 1/20W 4.7K J
RV551	24011472	METAL FILM CHIP 1/20W 4.7K J
RV552	24011472	METAL FILM CHIP 1/20W 4.7K J
RV700	24011472	METAL FILM CHIP 1/20W 4.7K J
RV850	24011361	METAL FILM CHIP 1/20W 360 J
RV870	24011361	METAL FILM CHIP 1/20W 360 J
RW10	24011102	CHIP, METAL FILM, 1/20W 1K OHM J
RW30	24011102	CHIP, METAL FILM, 1/20W 1K OHM J
RX11	24011221	METAL FILM CHIP 1/20W 220 J
RX12	24011221	METAL FILM CHIP 1/20W 220 J
RX103	24000445	CHIP JUMPER, 1608TYPE
RX105	24011152	CHIP, METAL FILM, 1/20W 1.5K OHM J
RX106	24011822	METAL FILM CHIP 1/20W 8.2K J
RX107	24011152	CHIP, METAL FILM, 1/20W 1.5K OHM J
RX108	24011152	CHIP, METAL FILM, 1/20W 1.5K OHM J
RX111	24011470	METAL FILM CHIP 1/20W 47 J
RX112	24871221	CHIP, METAL FILM, 1/8W 220 OHM J
RX113	24011121	METAL FILM CHIP 1/20W 120 J
RX114	24011471	METAL FILM CHIP 1/20W 470 J
RX115	24011272	METAL FILM CHIP 1/20W 2.7K J
RX116	24011121	METAL FILM CHIP 1/20W 120 J
RX117	24871331	METAL FILM CHIP 1/8W 330 J
RX118	24000445	CHIP JUMPER, 1608TYPE
RX119	24011471	METAL FILM CHIP 1/20W 470 J
RX121	24011470	METAL FILM CHIP 1/20W 47 J
RX122	24871681	CHIP, METAL FILM, 1/8W 680 OHM J
RX123	24011121	METAL FILM CHIP 1/20W 120 J
RX124	24011471	METAL FILM CHIP 1/20W 470 J
RX126	24011470	METAL FILM CHIP 1/20W 47 J
RX127	24871681	CHIP, METAL FILM, 1/8W 680 OHM J
RX128	24000445	CHIP JUMPER, 1608TYPE
RX129	24011471	METAL FILM CHIP 1/20W 470 J
RX131	24011470	METAL FILM CHIP 1/20W 47 J
RX132	24871681	CHIP, METAL FILM, 1/8W 680 OHM J
RX133	24011121	METAL FILM CHIP 1/20W 120 J

Location No.	Parts No.	Description
RX134	24011471	METAL FILM CHIP 1/20W 470 J
RX136	24011470	METAL FILM CHIP 1/20W 47 J
RX137	24871681	CHIP, METAL FILM, 1/8W 680 OHM J
RX138	24000445	CHIP JUMPER, 1608TYPE
RX139	24011471	METAL FILM CHIP 1/20W 470 J
RX141	24011470	METAL FILM CHIP 1/20W 47 J
RX142	24871681	CHIP, METAL FILM, 1/8W 680 OHM J
RX143	24011121	METAL FILM CHIP 1/20W 120 J
RX144	24011471	METAL FILM CHIP 1/20W 470 J
RX145	24011272	METAL FILM CHIP 1/20W 2.7K J
RX147	24871331	METAL FILM CHIP 1/8W 330 J
RX148	24000445	CHIP JUMPER, 1608TYPE
RX149	24011471	METAL FILM CHIP 1/20W 470 J
RX151	24011470	METAL FILM CHIP 1/20W 47 J
RX152	24871681	CHIP, METAL FILM, 1/8W 680 OHM J
RX153	24011121	METAL FILM CHIP 1/20W 120 J
RX154	24011471	METAL FILM CHIP 1/20W 470 J
RX157	24871681	CHIP, METAL FILM, 1/8W 680 OHM J
RX158	24000445	CHIP JUMPER, 1608TYPE
RX159	24011471	METAL FILM CHIP 1/20W 470 J
RX161	24011470	METAL FILM CHIP 1/20W 47 J
RX162	24871681	CHIP, METAL FILM, 1/8W 680 OHM J
RX163	24011121	METAL FILM CHIP 1/20W 120 J
RX164	24011471	METAL FILM CHIP 1/20W 470 J
RX167	24871681	CHIP, METAL FILM, 1/8W 680 OHM J
RX168	24000445	CHIP JUMPER, 1608TYPE
RX169	24011471	METAL FILM CHIP 1/20W 470 J
RX171	24011102	CHIP, METAL FILM, 1/20W 1K OHM J
RX172	24011102	CHIP, METAL FILM, 1/20W 1K OHM J
RX173	24011102	CHIP, METAL FILM, 1/20W 1K OHM J
RX174	24011102	CHIP, METAL FILM, 1/20W 1K OHM J
RX175	24011471	METAL FILM CHIP 1/20W 470 J
RX176	24011103	CHIP, METAL FILM, 1/20W 10K OHM J
RX177	24011471	METAL FILM CHIP 1/20W 470 J
RX178	24011471	METAL FILM CHIP 1/20W 470 J
RX183	24011471	METAL FILM CHIP 1/20W 470 J
RX184	24011152	CHIP, METAL FILM, 1/20W 1.5K OHM J
RX185	24871271	CHIP, METAL FILM, 1/8W 270 OHM J
RX186	24011100	CHIP, METAL FILM, 1/20W 10 OHM J
RX187	24871271	CHIP, METAL FILM, 1/8W 270 OHM J
RX188	24011100	CHIP, METAL FILM, 1/20W 10 OHM J
RX189	24011101	CHIP, METAL FILM, 1/20W 100 OHM J
RX190	24011101	CHIP, METAL FILM, 1/20W 100 OHM J
RX191	24011100	CHIP, METAL FILM, 1/20W 10 OHM J
RX192	24011101	CHIP, METAL FILM, 1/20W 100 OHM J
RX193	24011100	CHIP, METAL FILM, 1/20W 10 OHM J
RX194	24011101	CHIP, METAL FILM, 1/20W 100 OHM J
RX195	24011100	CHIP, METAL FILM, 1/20W 10 OHM J
RX197	24011100	CHIP, METAL FILM, 1/20W 10 OHM J
RX201	24011101	CHIP, METAL FILM, 1/20W 100 OHM J
RX202	24000445	CHIP JUMPER, 1608TYPE
RX203	24011102	CHIP, METAL FILM, 1/20W 1K OHM J
RX204	24011101	CHIP, METAL FILM, 1/20W 100 OHM J
RX205	24011102	CHIP, METAL FILM, 1/20W 1K OHM J
RX206	24011223	METAL FILM CHIP 1/20W 22K J
RX207	24011103	CHIP, METAL FILM, 1/20W 10K OHM J
RX209	24011221	METAL FILM CHIP 1/20W 220 J
RX210	24011221	METAL FILM CHIP 1/20W 220 J
RX211	24011101	CHIP, METAL FILM, 1/20W 100 OHM J
RX212	24011221	METAL FILM CHIP 1/20W 220 J
RX213	24011102	CHIP, METAL FILM, 1/20W 1K OHM J
RX214	24011101	CHIP, METAL FILM, 1/20W 100 OHM J
RX215	24011102	CHIP, METAL FILM, 1/20W 1K OHM J
RX216	24011100	CHIP, METAL FILM, 1/20W 10 OHM J
RX217	24011471	METAL FILM CHIP 1/20W 470 J

Location No.	Parts No.	Description
RX218	24011222	METAL FILM CHIP 1/20W 2.2K J
RX219	24011100	CHIP, METAL FILM, 1/20W 10 OHM J
RX220	24011100	CHIP, METAL FILM, 1/20W 10 OHM J
RX222	24011470	METAL FILM CHIP 1/20W 47 J
RX224	24011100	CHIP, METAL FILM, 1/20W 10 OHM J
RX225	24011470	METAL FILM CHIP 1/20W 47 J
RX227	24011100	CHIP, METAL FILM, 1/20W 10 OHM J
RX228	24011821	METAL FILM CHIP 1/20W 820 J
RX229	24011470	METAL FILM CHIP 1/20W 47 J
RX230	24011470	METAL FILM CHIP 1/20W 47 J
RX231	24011471	METAL FILM CHIP 1/20W 470 J
RX232	24011222	METAL FILM CHIP 1/20W 2.2K J
RX233	24011100	CHIP, METAL FILM, 1/20W 10 OHM J
RX236	24011100	CHIP, METAL FILM, 1/20W 10 OHM J
RX238	24011102	CHIP, METAL FILM, 1/20W 1K OHM J
RX242	24011470	METAL FILM CHIP 1/20W 47 J
RX244	24011100	CHIP, METAL FILM, 1/20W 10 OHM J
RX245	24011470	METAL FILM CHIP 1/20W 47 J
RX247	24011100	CHIP, METAL FILM, 1/20W 10 OHM J
RX248	24011681	METAL FILM CHIP 1/20W 680 J
RX249	24011470	METAL FILM CHIP 1/20W 47 J
RX250	24011470	METAL FILM CHIP 1/20W 47 J
RX251	24011471	METAL FILM CHIP 1/20W 470 J
RX252	24011272	METAL FILM CHIP 1/20W 2.7K J
RX253	24011100	CHIP, METAL FILM, 1/20W 10 OHM J
RX256	24011100	CHIP, METAL FILM, 1/20W 10 OHM J
RX258	24011102	CHIP, METAL FILM, 1/20W 1K OHM J
RX263	24011100	CHIP, METAL FILM, 1/20W 10 OHM J
RX266	24011100	CHIP, METAL FILM, 1/20W 10 OHM J
RX268	24011681	METAL FILM CHIP 1/20W 680 J
RX269	24011470	METAL FILM CHIP 1/20W 47 J
RX270	24011470	METAL FILM CHIP 1/20W 47 J
RX271	24011471	METAL FILM CHIP 1/20W 470 J
RX272	24011222	METAL FILM CHIP 1/20W 2.2K J
RX273	24011100	CHIP, METAL FILM, 1/20W 10 OHM J
RX276	24011100	CHIP, METAL FILM, 1/20W 10 OHM J
RX277	24011100	CHIP, METAL FILM, 1/20W 10 OHM J
RX304	24011103	CHIP, METAL FILM, 1/20W 10K OHM J
RX306	24019404	CHIP BLOCK P-8 1/16W P-8 103J
RX307	24011103	CHIP, METAL FILM, 1/20W 10K OHM J
RX309	24011103	CHIP, METAL FILM, 1/20W 10K OHM J
RX311	24019439	CHIP BLOCK P-8 1/16W P-8 470J
RX312	24019439	CHIP BLOCK P-8 1/16W P-8 470J
RX313	24019439	CHIP BLOCK P-8 1/16W P-8 470J
RX314	24019439	CHIP BLOCK P-8 1/16W P-8 470J
RX315	24019439	CHIP BLOCK P-8 1/16W P-8 470J
RX316	24019439	CHIP BLOCK P-8 1/16W P-8 470J
RX317	24019439	CHIP BLOCK P-8 1/16W P-8 470J
RX318	24019439	CHIP BLOCK P-8 1/16W P-8 470J
RX319	24019439	CHIP BLOCK P-8 1/16W P-8 470J
RX320	24019439	CHIP BLOCK P-8 1/16W P-8 470J
RX321	24019439	CHIP BLOCK P-8 1/16W P-8 470J
RX322	24019439	CHIP BLOCK P-8 1/16W P-8 470J
RX323	24011470	METAL FILM CHIP 1/20W 47 J
RX324	24011470	METAL FILM CHIP 1/20W 47 J
RX329	24011334	METAL FILM CHIP 1/20W 330K J
RX330	24011103	CHIP, METAL FILM, 1/20W 10K OHM J
RX331	24019404	CHIP BLOCK P-8 1/16W P-8 103J
RX332	24011103	CHIP, METAL FILM, 1/20W 10K OHM J
RX334	24011152	CHIP, METAL FILM, 1/20W 1.5K OHM J
RX335	24011332	METAL FILM CHIP 1/20W 3.3K J
RX342	24011271	METAL FILM CHIP 1/20W 270 J
RX343	24011820	METAL FILM CHIP 1/20W 82 J
RX345	24011271	METAL FILM CHIP 1/20W 270 J
RX346	24011820	METAL FILM CHIP 1/20W 82 J

Location No.	Parts No.	Description
RX347	24011100	CHIP, METAL FILM, 1/20W 10 OHM J
RX348	24011101	CHIP, METAL FILM, 1/20W 100 OHM J
RX349	24011100	CHIP, METAL FILM, 1/20W 10 OHM J
RX350	24011101	CHIP, METAL FILM, 1/20W 100 OHM J
RX351	24000445	CHIP JUMPER, 1608TYPE
RX352	24000445	CHIP JUMPER, 1608TYPE
RX361	24011181	METAL FILM CHIP 1/20W 180 J
RX362	24011270	METAL FILM CHIP 1/20W 27 J
RX363	24011122	CHIP, METAL FILM, 1/20W 1.2K OHM J
RX364	24011272	METAL FILM CHIP 1/20W 2.7K J
RX365	24011272	METAL FILM CHIP 1/20W 2.7K J
RX366	24011181	METAL FILM CHIP 1/20W 180 J
RX367	24011270	METAL FILM CHIP 1/20W 27 J
RX368	24011122	CHIP, METAL FILM, 1/20W 1.2K OHM J
RX369	24011272	METAL FILM CHIP 1/20W 2.7K J
RX370	24011181	METAL FILM CHIP 1/20W 180 J
RX371	24011270	METAL FILM CHIP 1/20W 27 J
RX372	24011122	CHIP, METAL FILM, 1/20W 1.2K OHM J
RX373	24011272	METAL FILM CHIP 1/20W 2.7K J
RX374	24011272	METAL FILM CHIP 1/20W 2.7K J
RX375	24011272	METAL FILM CHIP 1/20W 2.7K J
RX381	24011100	CHIP, METAL FILM, 1/20W 10 OHM J
RX382	24011100	CHIP, METAL FILM, 1/20W 10 OHM J
RX383	24011100	CHIP, METAL FILM, 1/20W 10 OHM J
RX384	24011100	CHIP, METAL FILM, 1/20W 10 OHM J
RX385	24011100	CHIP, METAL FILM, 1/20W 10 OHM J
RX386	24011100	CHIP, METAL FILM, 1/20W 10 OHM J
RX387	24011100	CHIP, METAL FILM, 1/20W 10 OHM J
RX391	24011101	CHIP, METAL FILM, 1/20W 100 OHM J
RX392	24011101	CHIP, METAL FILM, 1/20W 100 OHM J
RX393	24011102	CHIP, METAL FILM, 1/20W 1K OHM J
RX394	24011102	CHIP, METAL FILM, 1/20W 1K OHM J
RX395	24011332	METAL FILM CHIP 1/20W 3.3K J
RX396	24011332	METAL FILM CHIP 1/20W 3.3K J
RX397	24011103	CHIP, METAL FILM, 1/20W 10K OHM J
RX398	24872331	CHIP, METAL FILM, 1/16W 330 OHM J
RX399	24872331	CHIP, METAL FILM, 1/16W 330 OHM J
RX403	24011101	CHIP, METAL FILM, 1/20W 100 OHM J
RX404	24871101	CHIP, METAL FILM, 1/8W 100 OHM J
RX405	24011101	CHIP, METAL FILM, 1/20W 100 OHM J
RX406	24871471	CHIP, METAL FILM, 1/8W 470 OHM J
RX511	24011100	CHIP, METAL FILM, 1/20W 10 OHM J
RX512	24011681	METAL FILM CHIP 1/20W 680 J
RX521	24011100	CHIP, METAL FILM, 1/20W 10 OHM J
RX522	24011681	METAL FILM CHIP 1/20W 680 J
RX531	24011100	CHIP, METAL FILM, 1/20W 10 OHM J
RX532	24011681	METAL FILM CHIP 1/20W 680 J
RX554	24011121	METAL FILM CHIP 1/20W 120 J
RX555	24011681	METAL FILM CHIP 1/20W 680 J
RX557	24871681	CHIP, METAL FILM, 1/8W 680 OHM J
RX564	24011121	METAL FILM CHIP 1/20W 120 J
RX565	24011471	METAL FILM CHIP 1/20W 470 J
RX567	24871681	CHIP, METAL FILM, 1/8W 680 OHM J
RX574	24011121	METAL FILM CHIP 1/20W 120 J
RX575	24011471	METAL FILM CHIP 1/20W 470 J
RX577	24871681	CHIP, METAL FILM, 1/8W 680 OHM J
RX812	24011101	CHIP, METAL FILM, 1/20W 100 OHM J
RX821	24011151	CHIP, METAL FILM, 1/20W 150 OHM J
RX822	24011151	CHIP, METAL FILM, 1/20W 150 OHM J
RX823	24011151	CHIP, METAL FILM, 1/20W 150 OHM J
RX824	24011101	CHIP, METAL FILM, 1/20W 100 OHM J
RX825	24011101	CHIP, METAL FILM, 1/20W 100 OHM J
RX826	24011681	METAL FILM CHIP 1/20W 680 J
RX827	24011101	CHIP, METAL FILM, 1/20W 100 OHM J
RX829	24011102	CHIP, METAL FILM, 1/20W 1K OHM J



Location No.	Parts No.	Description
RX831	24011100	CHIP, METAL FILM, 1/20W 10 OHM J
RX832	24011100	CHIP, METAL FILM, 1/20W 10 OHM J
RX833	24011100	CHIP, METAL FILM, 1/20W 10 OHM J
RX844	24011101	CHIP, METAL FILM, 1/20W 100 OHM J
RX845	24011101	CHIP, METAL FILM, 1/20W 100 OHM J
RY01	24011102	CHIP, METAL FILM, 1/20W 1K OHM J
RY02	24011471	METAL FILM CHIP 1/20W 470 J
RY09	24011102	CHIP, METAL FILM, 1/20W 1K OHM J
RY10	24011102	CHIP, METAL FILM, 1/20W 1K OHM J
RY20	24011101	CHIP, METAL FILM, 1/20W 100 OHM J
RY21	24011101	CHIP, METAL FILM, 1/20W 100 OHM J
RY22	24011153	CHIP, METAL FILM, 1/20W 15K OHM J
RY23	24011332	METAL FILM CHIP 1/20W 3.3K J
RY24	24011102	CHIP, METAL FILM, 1/20W 1K OHM J
RY25	24011102	CHIP, METAL FILM, 1/20W 1K OHM J
RY26	24011331	METAL FILM CHIP 1/20W 330 J
RY27	24011330	METAL FILM CHIP 1/20W 33 J
RY28	24011153	CHIP, METAL FILM, 1/20W 15K OHM J
RY32	24011330	METAL FILM CHIP 1/20W 33 J
RY33	24011330	METAL FILM CHIP 1/20W 33 J
RY83	24011152	CHIP, METAL FILM, 1/20W 1.5K OHM J
RY84	24011101	CHIP, METAL FILM, 1/20W 100 OHM J
RY150	24011102	CHIP, METAL FILM, 1/20W 1K OHM J
RY151	24011471	METAL FILM CHIP 1/20W 470 J
RY152	24011102	CHIP, METAL FILM, 1/20W 1K OHM J
RY154	24011473	METAL FILM CHIP 1/20W 47K J
RY155	24011102	CHIP, METAL FILM, 1/20W 1K OHM J
RY156	24011182	METAL FILM CHIP 1/20W 1.8K J
RY157	24011102	CHIP, METAL FILM, 1/20W 1K OHM J
RY190	24011103	CHIP, METAL FILM, 1/20W 10K OHM J
RY212	24011103	CHIP, METAL FILM, 1/20W 10K OHM J
RY213	24011123	CHIP, METAL FILM, 1/20W 12K OHM J
RY214	24011222	METAL FILM CHIP 1/20W 2.2K J
RY510	24011102	CHIP, METAL FILM, 1/20W 1K OHM J
RY511	24011472	METAL FILM CHIP 1/20W 4.7K J
RY520	24011472	METAL FILM CHIP 1/20W 4.7K J
RY521	24011472	METAL FILM CHIP 1/20W 4.7K J
RY522	24011472	METAL FILM CHIP 1/20W 4.7K J
RY523	24011222	METAL FILM CHIP 1/20W 2.2K J
RY524	24011222	METAL FILM CHIP 1/20W 2.2K J
RY525	24011222	METAL FILM CHIP 1/20W 2.2K J
RY526	24011682	METAL FILM CHIP 1/20W 6.8K J
RY527	24011222	METAL FILM CHIP 1/20W 2.2K J
RY528	24011682	METAL FILM CHIP 1/20W 6.8K J
RY529	24011472	METAL FILM CHIP 1/20W 4.7K J
RY530	24011472	METAL FILM CHIP 1/20W 4.7K J
RY531	24011472	METAL FILM CHIP 1/20W 4.7K J
RY532	24011101	CHIP, METAL FILM, 1/20W 100 OHM J
RY533	24011101	CHIP, METAL FILM, 1/20W 100 OHM J
RY534	24011101	CHIP, METAL FILM, 1/20W 100 OHM J
RY544	24011103	CHIP, METAL FILM, 1/20W 10K OHM J
RY545	24011103	CHIP, METAL FILM, 1/20W 10K OHM J
RY546	24011103	CHIP, METAL FILM, 1/20W 10K OHM J
RY601	24011334	METAL FILM CHIP 1/20W 330K J
RY602	24011470	METAL FILM CHIP 1/20W 47 J
RY603	24011470	METAL FILM CHIP 1/20W 47 J
RY612	24011470	METAL FILM CHIP 1/20W 47 J
RY613	24011470	METAL FILM CHIP 1/20W 47 J
RY614	24011122	CHIP, METAL FILM, 1/20W 1.2K OHM J
RY615	24011100	CHIP, METAL FILM, 1/20W 10 OHM J
RY616	24011223	METAL FILM CHIP 1/20W 22K J
RY617	24011103	CHIP, METAL FILM, 1/20W 10K OHM J
RY621	24011102	CHIP, METAL FILM, 1/20W 1K OHM J
RY622	24011152	CHIP, METAL FILM, 1/20W 1.5K OHM J
RY623	24011102	CHIP, METAL FILM, 1/20W 1K OHM J

Location No.	Parts No.	Description
RY661	24011102	CHIP, METAL FILM, 1/20W 1K OHM J
RY663	24011102	CHIP, METAL FILM, 1/20W 1K OHM J
RY806	24011101	CHIP, METAL FILM, 1/20W 100 OHM J
RY810	24011101	CHIP, METAL FILM, 1/20W 100 OHM J
RZ01	24011330	METAL FILM CHIP 1/20W 33 J
RZ02	24011152	CHIP, METAL FILM, 1/20W 1.5K OHM J
RZ03	24011682	METAL FILM CHIP 1/20W 6.8K J
RZ04	24011392	METAL FILM CHIP 1/20W 3.9K J
RZ05	24011122	CHIP, METAL FILM, 1/20W 1.2K OHM J
RZ06	24011431	METAL FILM CHIP 1/20W 430 J
RZ07	24871331	METAL FILM CHIP 1/8W 330 J
RZ08	24011151	CHIP, METAL FILM, 1/20W 150 OHM J
RZ09	24011330	METAL FILM CHIP 1/20W 33 J
RZ10	24011102	CHIP, METAL FILM, 1/20W 1K OHM J
RZ11	24011561	METAL FILM CHIP 1/20W 560 J
RZ12	24011182	METAL FILM CHIP 1/20W 1.8K J
RZ13	24011392	METAL FILM CHIP 1/20W 3.9K J
RZ14	24011123	CHIP, METAL FILM, 1/20W 12K OHM J
RZ15	24011151	CHIP, METAL FILM, 1/20W 150 OHM J
RZ16	24011102	CHIP, METAL FILM, 1/20W 1K OHM J
RZ17	24871181	METAL FILM CHIP 1/8W 180 J
RZ18	24011121	METAL FILM CHIP 1/20W 120 J
RZ21	24011271	METAL FILM CHIP 1/20W 270 J
RZ28	24011102	CHIP, METAL FILM, 1/20W 1K OHM J
RZ30	24000445	CHIP JUMPER, 1608TYPE
RZ31	24011104	CHIP, METAL FILM, 1/20W 100K OHM J
RZ32	24000445	CHIP JUMPER, 1608TYPE
RZ33	24011101	CHIP, METAL FILM, 1/20W 100 OHM J
RZ34	24011101	CHIP, METAL FILM, 1/20W 100 OHM J
RZ49	24011102	CHIP, METAL FILM, 1/20W 1K OHM J
RZ60	24011102	CHIP, METAL FILM, 1/20W 1K OHM J
RZ64	24011221	METAL FILM CHIP 1/20W 220 J
RZ65	24011224	METAL FILM CHIP 1/20W 220K J
RZ66	24011223	METAL FILM CHIP 1/20W 22K J
RZ67	24011102	CHIP, METAL FILM, 1/20W 1K OHM J
RZ68	24011222	METAL FILM CHIP 1/20W 2.2K J
RZ69	24011153	CHIP, METAL FILM, 1/20W 15K OHM J
RZ70	24011472	METAL FILM CHIP 1/20W 4.7K J
RZ71	24011101	CHIP, METAL FILM, 1/20W 100 OHM J
RZ72	24011103	CHIP, METAL FILM, 1/20W 10K OHM J
RZ73	24011103	CHIP, METAL FILM, 1/20W 10K OHM J
RZ74	24872229	METAL FILM CHIP 1/16W 2R2 J
RZ80	24019439	CHIP BLOCK P-8 1/16W P-8 470J
RZ81	24019439	CHIP BLOCK P-8 1/16W P-8 470J
RZ82	24019439	CHIP BLOCK P-8 1/16W P-8 470J
RZ83	24019439	CHIP BLOCK P-8 1/16W P-8 470J
RZ84	24019439	CHIP BLOCK P-8 1/16W P-8 470J
RZ85	24019439	CHIP BLOCK P-8 1/16W P-8 470J
RZ86	24011470	METAL FILM CHIP 1/20W 47 J
RZ101	24011101	CHIP, METAL FILM, 1/20W 100 OHM J
RZ102	24011221	METAL FILM CHIP 1/20W 220 J
RZ103	24011102	CHIP, METAL FILM, 1/20W 1K OHM J
RZ104	24011102	CHIP, METAL FILM, 1/20W 1K OHM J
RZ105	24011821	METAL FILM CHIP 1/20W 820 J
RZ106	24000445	CHIP JUMPER, 1608TYPE
RZ107	24011751	METAL FILM CHIP 1/20W 750 J
RZ109	24011102	CHIP, METAL FILM, 1/20W 1K OHM J
RZ110	24011152	CHIP, METAL FILM, 1/20W 1.5K OHM J
RZ243	24011220	METAL FILM CHIP 1/20W 22 J
RZ244	24011152	CHIP, METAL FILM, 1/20W 1.5K OHM J
RZ245	24011220	METAL FILM CHIP 1/20W 22 J
RZ246	24011152	CHIP, METAL FILM, 1/20W 1.5K OHM J
RZ265	24011472	METAL FILM CHIP 1/20W 4.7K J
RZ266	24011103	CHIP, METAL FILM, 1/20W 10K OHM J
RZ800	24871330	METAL FILM CHIP 1/8W 33 J

Location No.	Parts No.	Description
RZ802	24871330	METAL FILM CHIP 1/8W 33 J
RZ804	24011330	METAL FILM CHIP 1/20W 33 J
<b>COILS &amp; TRANSFORMERS</b>		
L101	23289846	COIL, PEAKING, TRF4101AT
L103	23289840	COIL, PEAKING, TRF4100AT
L104	23103852	COIL, FILTER, TEM2028AH
L105	23103852	COIL, FILTER, TEM2028AH
L111	23289846	COIL, PEAKING, TRF4101AT
L113	23289840	COIL, PEAKING, TRF4100AT
L121	23289834	COIL, PEAKING 1.00MMHK COLTRF41R0AT
L122	23289834	COIL, PEAKING 1.00MMHK COLTRF41R0AT
L301	23103859	COIL, CHOKE, TEM2011
L302	23237975	COIL, PEAKING, TRF4101AC
L400	23280022	COIL, PEAKING, TRF4101AZ
L402	23103859	COIL, CHOKE, TEM2011
L404	23103880	COIL, CHOKE, TEM2011Y
L409	23248191	COIL, CHOKE, TLN3351AD
L410	23248183	COIL, CHOKE TLN3343AD
△ L441	23233982	COIL, HORIZ.LIN TLN2158AG
L442	23248168	COIL, CHOKE TLN3328AD
△ L447	23248232	COIL, CHOKE TLN3435AE
L460	23103880	COIL, CHOKE, TEM2011Y
△ L461	23248115	COIL, CHOKE, TLN3367D
L463	23103880	COIL, CHOKE, TEM2011Y
L491	23228784	TRANSFORMER, DPC 16.4UH TPC1015AH
L499	23248026	COIL, CHOKE, TLN3269D
L501	23289470	COIL, PEAKING, TRF4470AF
L503	23289470	COIL, PEAKING, TRF4470AF
L504	23103827	INDUCTOR, BEAD TEM2120M
L506	23103827	INDUCTOR, BEAD TEM2120M
L511	23280016	COIL, PEAKING, TRF4100AZ
L702	23261974	COIL, FERRITE BEAD, HC5-035
L704	23103859	COIL, CHOKE, TEM2011
L705	23103859	COIL, CHOKE, TEM2011
L706	23237987	COIL, PEAKING, TRF4100AC
L805	23248227	COIL, CHOKE, TLN3481AD
L806	23248227	COIL, CHOKE, TLN3481AD
L833	23248236	COIL, CHOKE, TLN3441AF
L834	23280018	COIL, PEAKING, TRF4220AZ
L835	23248157	COIL, CHOKE TLN3433AD
L836	23248235	COIL, CHOKE 12X18H 22MMH 4.2A TLN3462AF
L837	23280018	COIL, PEAKING, TRF4220AZ
L861	23103941	COIL, CHOKE, TEM2011
L862	23103880	COIL, CHOKE, TEM2011Y
L883	23103880	COIL, CHOKE, TEM2011Y
L884	23103880	COIL, CHOKE, TEM2011Y
L885	23248073	COIL, CHOKE, TLN3299D
L886	23103880	COIL, CHOKE, TEM2011Y
L887	23103880	COIL, CHOKE, TEM2011Y
L888	23248087	COIL, CHOKE, TLN3312D
L889	23248087	COIL, CHOKE, TLN3312D
L891	23103880	COIL, CHOKE, TEM2011Y
L892	23103880	COIL, CHOKE, TEM2011Y
L893	23248235	COIL, CHOKE 12X18H 22MMH 4.2A TLN3462AF
L894	23248235	COIL, CHOKE 12X18H 22MMH 4.2A TLN3462AF
L895	23103880	COIL, CHOKE, TEM2011Y
L896	23103880	COIL, CHOKE, TEM2011Y
L897	23280016	COIL, PEAKING, TRF4100AZ
L901	23200447	COIL, DG1.10CU T-2LOOP TSB-2407AK (36HFX71)
L901	23200455	COIL, TSB-2412AT (32HFX71)

Location No.	Parts No.	Description
L902	23237975	COIL, PEAKING, TRF4101AC
L903	23237975	COIL, PEAKING, TRF4101AC
L904	23237975	COIL, PEAKING, TRF4101AC
L905	23238712	COIL, PEAKING, TRF4150AJ
L906	23238712	COIL, PEAKING, TRF4150AJ
L907	23238712	COIL, PEAKING, TRF4150AJ
L908	23289840	COIL, PEAKING, TRF4100AT
L910	23237999	COIL, PEAKING, TRF4109AC
L911	23237975	COIL, PEAKING, TRF4101AC
LJ901	23200465	COIL, GEOMAGNETIC CORRECTION TSB-2411AG
LM09	23103906	FILTER, CHIP BEAD INDUCTOR TEM2118AS
LV01	23103845	COIL, COMMONMODE, TEM2030AY
LV17	23103852	COIL, FILTER, TEM2028AH
LV19	23289560	COIL, PEAKING, TRF4560AF
LV21	23289101	COIL, PEAKING, TRF4101AF
LV71	23289840	COIL, PEAKING, TRF4100AT
LV248	23103845	COIL, COMMONMODE, TEM2030AY
LV502	23103906	FILTER, CHIP BEAD INDUCTOR TEM2118AS
LV503	24000445	CHIP JUMPER, 1608TYPE
LX101	23103906	FILTER, CHIP BEAD INDUCTOR TEM2118AS
LX102	23103906	FILTER, CHIP BEAD INDUCTOR TEM2118AS
LX103	23103906	FILTER, CHIP BEAD INDUCTOR TEM2118AS
LX104	23103906	FILTER, CHIP BEAD INDUCTOR TEM2118AS
LX111	23246323	COIL, CHIP INDUCTOR 4.7MMH COLTRF44R7CT
LX121	23246323	COIL, CHIP INDUCTOR 4.7MMH COLTRF44R7CT
LX131	23246323	COIL, CHIP INDUCTOR 4.7MMH COLTRF44R7CT
LX141	23246323	COIL, CHIP INDUCTOR 4.7MMH COLTRF44R7CT
LX151	23246323	COIL, CHIP INDUCTOR 4.7MMH COLTRF44R7CT
LX161	23246323	COIL, CHIP INDUCTOR 4.7MMH COLTRF44R7CT
LX171	23103906	FILTER, CHIP BEAD INDUCTOR TEM2118AS
LX172	23103906	FILTER, CHIP BEAD INDUCTOR TEM2118AS
LX173	24000445	CHIP JUMPER, 1608TYPE
LX174	23103906	FILTER, CHIP BEAD INDUCTOR TEM2118AS
LX175	23103806	INDUCTOR, BEAD TEM2114T
LX186	23103823	COIL, COMMONMODE TEM2027D
LX187	23103823	COIL, COMMONMODE TEM2027D
LX206	23103906	FILTER, CHIP BEAD INDUCTOR TEM2118AS
LX216	23103906	FILTER, CHIP BEAD INDUCTOR TEM2118AS
LX221	23103906	FILTER, CHIP BEAD INDUCTOR TEM2118AS
LX222	23103906	FILTER, CHIP BEAD INDUCTOR TEM2118AS
LX223	23103906	FILTER, CHIP BEAD INDUCTOR TEM2118AS
LX224	23103906	FILTER, CHIP BEAD INDUCTOR TEM2118AS
LX225	23103906	FILTER, CHIP BEAD INDUCTOR TEM2118AS
LX226	23103906	FILTER, CHIP BEAD INDUCTOR TEM2118AS
LX227	23103906	FILTER, CHIP BEAD INDUCTOR TEM2118AS
LX228	23103906	FILTER, CHIP BEAD INDUCTOR TEM2118AS
LX229	23103823	COIL, COMMONMODE TEM2027D
LX241	23103906	FILTER, CHIP BEAD INDUCTOR TEM2118AS
LX242	23103906	FILTER, CHIP BEAD INDUCTOR TEM2118AS
LX243	23103906	FILTER, CHIP BEAD INDUCTOR TEM2118AS
LX244	23103906	FILTER, CHIP BEAD INDUCTOR TEM2118AS
LX245	23103906	FILTER, CHIP BEAD INDUCTOR TEM2118AS
LX246	23103906	FILTER, CHIP BEAD INDUCTOR TEM2118AS
LX247	23103906	FILTER, CHIP BEAD INDUCTOR TEM2118AS
LX249	23103823	COIL, COMMONMODE TEM2027D
LX260	23103906	FILTER, CHIP BEAD INDUCTOR TEM2118AS
LX262	23103906	FILTER, CHIP BEAD INDUCTOR TEM2118AS
LX263	23103906	FILTER, CHIP BEAD INDUCTOR TEM2118AS

Location No.	Parts No.	Description
LX265	23103906	FILTER, CHIP BEAD INDUCTOR TEM2118AS
LX266	23103906	FILTER, CHIP BEAD INDUCTOR TEM2118AS
LX267	23103906	FILTER, CHIP BEAD INDUCTOR TEM2118AS
LX269	23103823	COIL, COMMONMODE TEM2027D
LX301	23103886	INDUCTOR, CHIP BEAD 3A 60OHM
LX302	24000824	JUMPER CHIP, 2125TYPE
LX303	23103886	INDUCTOR, CHIP BEAD 3A 60OHM
LX310	23103886	INDUCTOR, CHIP BEAD 3A 60OHM
LX312	23246199	COIL, CHIP-INDUCTOR-2R2MMHJ COLTRF42R2CG
LX320	23103886	INDUCTOR, CHIP BEAD 3A 60OHM
LX330	23103887	INDUCTOR, CHIP BEAD 3A 220OHM
LX331	23103886	INDUCTOR, CHIP BEAD 3A 60OHM
LX340	23103906	FILTER, CHIP BEAD INDUCTOR TEM2118AS
LX341	23103906	FILTER, CHIP BEAD INDUCTOR TEM2118AS
LX342	24000445	CHIP JUMPER, 1608TYPE
LX343	23103906	FILTER, CHIP BEAD INDUCTOR TEM2118AS
LX344	24000445	CHIP JUMPER, 1608TYPE
LX346	24000445	CHIP JUMPER, 1608TYPE
LX347	24000445	CHIP JUMPER, 1608TYPE
LX348	23103806	INDUCTOR, BEAD TEM2114T
LX349	23103806	INDUCTOR, BEAD TEM2114T
LX360	23103806	INDUCTOR, BEAD TEM2114T
LX363	23103906	FILTER, CHIP BEAD INDUCTOR TEM2118AS
LX364	23103906	FILTER, CHIP BEAD INDUCTOR TEM2118AS
LX391	23103906	FILTER, CHIP BEAD INDUCTOR TEM2118AS
LX470	23103906	FILTER, CHIP BEAD INDUCTOR TEM2118AS
LX473	23246325	COIL, CHIP INDUCTOR 22MMH COLTRF4220CT
LX500	23103806	INDUCTOR, BEAD TEM2114T
LX542	23103906	FILTER, CHIP BEAD INDUCTOR TEM2118AS
LX551	23103823	COIL, COMMONMODE TEM2027D
LX552	23246199	COIL, CHIP-INDUCTOR-2R2MMHJ COLTRF42R2CG
LX561	23103823	COIL, COMMONMODE TEM2027D
LX562	23246323	COIL, CHIP INDUCTOR 4.7MMH COLTRF44R7CT
LX571	23103823	COIL, COMMONMODE TEM2027D
LX572	23246323	COIL, CHIP INDUCTOR 4.7MMH COLTRF44R7CT
LX648	23103906	FILTER, CHIP BEAD INDUCTOR TEM2118AS
LY09	23103827	INDUCTOR, BEAD TEM2120M
LY23	23289840	COIL, PEAKING, TRF4100AT
LY64	23103827	INDUCTOR, BEAD TEM2120M
LY305	23103906	FILTER, CHIP BEAD INDUCTOR TEM2118AS
LY306	23103906	FILTER, CHIP BEAD INDUCTOR TEM2118AS
LY311	23103906	FILTER, CHIP BEAD INDUCTOR TEM2118AS
LY312	23103906	FILTER, CHIP BEAD INDUCTOR TEM2118AS
LY331	23103886	INDUCTOR, CHIP BEAD 3A 60OHM
LY332	23103886	INDUCTOR, CHIP BEAD 3A 60OHM
LY502	23103906	FILTER, CHIP BEAD INDUCTOR TEM2118AS
LY503	24000445	CHIP JUMPER, 1608TYPE
LY601	23103906	FILTER, CHIP BEAD INDUCTOR TEM2118AS
LY602	23103906	FILTER, CHIP BEAD INDUCTOR TEM2118AS
LY611	23246199	COIL, CHIP-INDUCTOR-2R2MMHJ COLTRF42R2CG
LY620	23103906	FILTER, CHIP BEAD INDUCTOR TEM2118AS
LY621	23103906	FILTER, CHIP BEAD INDUCTOR TEM2118AS
LY660	23103906	FILTER, CHIP BEAD INDUCTOR TEM2118AS
LY661	23103906	FILTER, CHIP BEAD INDUCTOR TEM2118AS
LZ03	24000445	CHIP JUMPER, 1608TYPE
LZ05	23103906	FILTER, CHIP BEAD INDUCTOR TEM2118AS
LZ09	23103906	FILTER, CHIP BEAD INDUCTOR TEM2118AS
LZ20	23246316	COIL, CHIP INDUCTOR 4.7MMH COLTRF44R7CR

Location No.	Parts No.	Description
LZ21	23246317	COIL, CHIP INDUCTOR, TRF4100CR
LZ22	23246199	COIL, CHIP-INDUCTOR-2R2MMHJ COLTRF42R2CG
LZ25	23103906	FILTER, CHIP BEAD INDUCTOR TEM2118AS
LZ26	23103906	FILTER, CHIP BEAD INDUCTOR TEM2118AS
LZ28	23103906	FILTER, CHIP BEAD INDUCTOR TEM2118AS
LZ29	23103906	FILTER, CHIP BEAD INDUCTOR TEM2118AS
LZ30	24000445	CHIP JUMPER, 1608TYPE
LZ31	23103906	FILTER, CHIP BEAD INDUCTOR TEM2118AS
LZ32	23103906	FILTER, CHIP BEAD INDUCTOR TEM2118AS
LZ34	24000445	CHIP JUMPER, 1608TYPE
LZ35	23103906	FILTER, CHIP BEAD INDUCTOR TEM2118AS
LZ36	23103906	FILTER, CHIP BEAD INDUCTOR TEM2118AS
LZ38	23103906	FILTER, CHIP BEAD INDUCTOR TEM2118AS
LZ39	23103906	FILTER, CHIP BEAD INDUCTOR TEM2118AS
LZ96	23246206	COIL, CHIP-INDUCTOR-8R2MMHJ COLTRF48R2CG
LZ100	23246223	COIL, CHIP INDUCTOR, TRF4330CG
LZ101	23103827	INDUCTOR, BEAD TEM2120M
LZ102	23103827	INDUCTOR, BEAD TEM2120M
LZ103	23103906	FILTER, CHIP BEAD INDUCTOR TEM2118AS
LZ104	23246219	COIL, CHIP INDUCTOR, TRF4150CG
LZ105	23246222	COIL, CHIP-INDUCTOR-270MMHJ COLTRF4270CG
T400	23224364	TRANSFORMER, TLN2168AH
T401	23224371	TRANSFORMER, HORIZ DRIVE, TLN1080AH
△ T461	23236717	TRANSFORMER, FLY-BACK TFB4165BH (32HFX71)
△ T461Z	23236644	TRANSFORMER, FLY-BACK TFB4165ZD
T802	23211729	COIL, LINE FILTER TRF3232AQ
T840	23217530	TRANSFORMER, POWER EI28 9.1V TPW1570AT
T862	23217485	TRANSFORMER, CONVERTER TPW3462AS
<b>SEMICONDUCTORS</b>		
Q151	23205054	TRANSISTOR, CHIP -50V -150MA SM KTA1504Y
Q152	23205057	TRANSISTOR, CHIP 50V 150MA SM KTC3875Y
Q171	23205057	TRANSISTOR, CHIP 50V 150MA SM KTC3875Y
Q172	23205057	TRANSISTOR, CHIP 50V 150MA SM KTC3875Y
Q201	23114528	TRANSISTOR, 2SC1740S
Q210	23314994	TRANSISTOR, 2SA1576A106
Q211	23314993	TRANSISTOR, 2SC4081 Q
Q213	23205014	TRANSISTOR, HIGH SPEED SWICH 2SC4667-O
Q220	23114460	TRANSISTOR, RN1204
Q221	23114460	TRANSISTOR, RN1204
Q301	23905610	IC, LA7846N
Q301B	70391355	SCREW, 3X8MM
Q302	B0385853	IC, E-W CORRECTION IC NDIP 24 TA1241AN
Q305	23906077	IC, OP-AMP DUAL POWER 8P TCA0372 DP1
Q306	23114530	TRANSISTOR, 2SA933S
Q307	23114528	TRANSISTOR, 2SC1740S
Q308	23114528	TRANSISTOR, 2SC1740S
Q340	23205057	TRANSISTOR, CHIP 50V 150MA SM KTC3875Y
Q360	23205057	TRANSISTOR, CHIP 50V 150MA SM KTC3875Y
Q370	23114530	TRANSISTOR, 2SA933S
Q390	B0350510	IC, TA75558S
Q391	23314959	TRANSISTOR, VCEO1200V 10M

Location No.	Parts No.	Description
Q402	A6325413	TRANSISTOR, 2SC22350 (FA-1)
Q404	A6374144	TRANSISTOR, 2SC5570(FA)
Q404B	A8012650	INSULATOR, TRANSISTOR, AC263
Q404D	72471082	SCREW, 3X10MM
Q408	A6002020	TRANSISTOR, RN1202
Q409	A6002020	TRANSISTOR, RN1202
Q410	23314994	TRANSISTOR, 2SA1576A106
Q418	23314141	TRANSISTOR, 2SC3852
Q418B	70391354	SCREW
Q420	B01A0156	IC, FRONT END PROCESSOR
Q422	23114499	TRANSISTOR, RN1404(TE85L
Q425	23205057	TRANSISTOR, CHIP 50V 150MA SM KTC3875Y
Q426	A6004061	TRANSISTOR, RN1406
Q427	A6004061	TRANSISTOR, RN1406
Q428	A6004061	TRANSISTOR, RN1406
Q430	23319202	IC, +9V 4% REGULATOR IO=1A TO22 MC7809CT
Q431	23114499	TRANSISTOR, RN1404(TE85L
Q434	23314917	TRANSISTOR, 2SK2003-01MR
Q437	23114528	TRANSISTOR, 2SC1740S
Q438	A6066750	TRANSISTOR, 2SK1356
Q460	23314938	TRANSISTOR, 2SD2493(P)
Q460B	72471082	SCREW, 3X10MM
Q462	23114530	TRANSISTOR, 2SA933S
Q465	23114530	TRANSISTOR, 2SA933S
Q470	23114759	TRANSISTOR, 2SA949-Y
Q470	23205057	TRANSISTOR, CHIP 50V 150MA SM KTC3875Y
Q476	23114459	TRANSISTOR, RN1205
Q484	23114530	TRANSISTOR, 2SA933S
Q486	23114528	TRANSISTOR, 2SC1740S
Q486	23114433	TRANSISTOR, 2SC1815-Y
Q495	A8641063	PHOTO COUPLER, TLP521-1 (FA)
Q498	A6002060	TRANSISTOR, RN1206
Q501	B0386049	IC, BUS P/N VCD IC QFP48 TA1270AF(J)
Q502	23000263	IC, CMOS MULTIPLEXER SOP16 BU4053BCF
Q503	23314994	TRANSISTOR, 2SA1576A106
Q504	23314993	TRANSISTOR, 2SC4081 Q
Q510	23000584	IC, BACK END PROCESSOR 56DIP TA1316AN
Q550	23205054	TRANSISTOR, CHIP -50V -150MA SM KTA1504Y
Q551	23205054	TRANSISTOR, CHIP -50V -150MA SM KTA1504Y
Q552	23205054	TRANSISTOR, CHIP -50V -150MA SM KTA1504Y
Q610	23906523	IC, 3CH POWER IC H-ZIP12PIN TA8256BH
Q610B	70391355	SCREW, 3X8MM
Q611	A6359871	TRANSISTOR, 2SC3326B (L)
Q612	23205054	TRANSISTOR, CHIP -50V -150MA SM KTA1504Y
Q613	A6359871	TRANSISTOR, 2SC3326B (L)
Q670	A6359871	TRANSISTOR, 2SC3326B (L)
Q683	23205057	TRANSISTOR, CHIP 50V 150MA SM KTC3875Y
Q705	23114433	TRANSISTOR, 2SC1815-Y
Q706	23114433	TRANSISTOR, 2SC1815-Y
Q707	23114437	TRANSISTOR, 2SC752GTM-Y
Q709	23114433	TRANSISTOR, 2SC1815-Y
Q710	23114425	TRANSISTOR, 2SA1015-Y(TE
Q711	A6550640	TRANSISTOR, 2SA1837
Q712	A6369650	TRANSISTOR, 2SC4793
Q719	23114433	TRANSISTOR, 2SC1815-Y
Q720	23114433	TRANSISTOR, 2SC1815-Y

Location No.	Parts No.	Description
Q801	23135013	IC, STR-Z4317
Q801B	23476828	BRACKET IC MOUNTING, TMX LOCAL CF35F50
Q805	23114459	TRANSISTOR, RN1205
Q831	23319203	IC, +12V 4% REGULATOR IO1A TO22 MC7812CT
Q831B	70391355	SCREW, 3X8MM
Q835	23000546	IC, SWITCHING REG SI-8050SS
Q835B	70391355	SCREW, 3X8MM
Q836	23319202	IC, +9V 4% REGULATOR IO=1A TO22 MC7809CT
Q836	A6002060	TRANSISTOR, RN1206
Q836B	70391355	SCREW, 3X8MM
Q837	23319202	IC, +9V 4% REGULATOR IO=1A TO22 MC7809CT
Q837B	70391355	SCREW, 3X8MM
Q838	23319202	IC, +9V 4% REGULATOR IO=1A TO22 MC7809CT
Q838B	70391355	SCREW, 3X8MM
Q839	23905239	IC, PQ30RV1
Q839B	70391355	SCREW, 3X8MM
Q840	23905976	IC, PQ05RD11
Q840B	70391355	SCREW, 3X8MM
Q843	23114528	TRANSISTOR, 2SC1740S
Q862	23000823	PHOTO COUPLER, CTR=(100-300)% TLP421F(GR)
△ Q883	23319692	IC, ERROR AMP. VS=130.2V TO220A SE130N, LF4
Q901	23314780	TRANSISTOR, 2SC4544
Q902	23114433	TRANSISTOR, 2SC1815-Y
Q903	23314780	TRANSISTOR, 2SC4544
Q904	23114433	TRANSISTOR, 2SC1815-Y
Q905	23314780	TRANSISTOR, 2SC4544
Q906	23114433	TRANSISTOR, 2SC1815-Y
Q907	23114735	TRANSISTOR, 2SA102-Y(C)
Q908	23114429	TRANSISTOR, 2SC2120-Y(TE
Q910	23114433	TRANSISTOR, 2SC1815-Y
Q911	23114433	TRANSISTOR, 2SC1815-Y
Q912	23114425	TRANSISTOR, 2SA1015-Y(TE
Q913	23114425	TRANSISTOR, 2SA1015-Y(TE
Q914	23114433	TRANSISTOR, 2SC1815-Y
Q917	23114433	TRANSISTOR, 2SC1815-Y
Q918	23114433	TRANSISTOR, 2SC1815-Y
Q919	23114433	TRANSISTOR, 2SC1815-Y
Q920	23114433	TRANSISTOR, 2SC1815-Y
Q921	23114433	TRANSISTOR, 2SC1815-Y
Q922	23114433	TRANSISTOR, 2SC1815-Y
Q2104	23114530	TRANSISTOR, 2SA933S
Q2105	23114530	TRANSISTOR, 2SA933S
Q2106	23114530	TRANSISTOR, 2SA933S
Q3103	23205054	TRANSISTOR, CHIP -50V -150MA SM KTA1504Y
Q4460	23114528	TRANSISTOR, 2SC1740S
Q4461	23114528	TRANSISTOR, 2SC1740S
Q4462	23114528	TRANSISTOR, 2SC1740S
Q4819	23114528	TRANSISTOR, 2SC1740S
QA01	23000900	IC, MCU 1CHIP 16BIT 4M 64
QA02	23906642	IC, AT24C64-10PC
QA14	23205054	TRANSISTOR, CHIP -50V -150MA SM KTA1504Y
QA21	23205057	TRANSISTOR, CHIP 50V 150MA SM KTC3875Y
QA27	23904896	IC, JLC1562BF
QA70	23319935	IC, MM1096BS

Location No.	Parts No.	Description
QA71	23205057	TRANSISTOR, CHIP 50V 150MA SM KTC3875Y
QA72	23205057	TRANSISTOR, CHIP 50V 150MA SM KTC3875Y
QA80	23906295	IC, UPC29M33HB
QA81	70200563	IC, RESET VS=2.9V PST9129 PST9129
QB03	A6004051	TRANSISTOR, RN1405
QB05	23205057	TRANSISTOR, CHIP 50V 150MA SM KTC3875Y
QB11	23114528	TRANSISTOR, 2SC1740S
QB14	23205057	TRANSISTOR, CHIP 50V 150MA SM KTC3875Y
QB15	23205057	TRANSISTOR, CHIP 50V 150MA SM KTC3875Y
QB30	23114528	TRANSISTOR, 2SC1740S
QB41	23205054	TRANSISTOR, CHIP -50V -150MA SM KTA1504Y
QB42	23205054	TRANSISTOR, CHIP -50V -150MA SM KTA1504Y
QB43	23205057	TRANSISTOR, CHIP 50V 150MA SM KTC3875Y
QB44	23114499	TRANSISTOR, RN1404(TE85L
QB45	23205057	TRANSISTOR, CHIP 50V 150MA SM KTC3875Y
QB55	23205057	TRANSISTOR, CHIP 50V 150MA SM KTC3875Y
QB92	23205057	TRANSISTOR, CHIP 50V 150MA SM KTC3875Y
QB93	23205054	TRANSISTOR, CHIP -50V -150MA SM KTA1504Y
QB94	23205054	TRANSISTOR, CHIP -50V -150MA SM KTA1504Y
QB95	23205054	TRANSISTOR, CHIP -50V -150MA SM KTA1504Y
QB96	23205054	TRANSISTOR, CHIP -50V -150MA SM KTA1504Y
QD01	23000381	IC, 2CH AUDIO PRO N-DIP22PIN CXA2021S
QD41	23000725	IC, SRS WOW AUDIO SDIP42 NJM2700L
QD42	A6059430	TRANSISTOR, 2SK372 V
QD44	23114460	TRANSISTOR, RN1204
QD101	B0385647	IC, 4CH AUDIO PRO.N-DIP36PIN TA1217AN
QD103	23114460	TRANSISTOR, RN1204
QJ02	23114528	TRANSISTOR, 2SC1740S
QJ03	A6369650	TRANSISTOR, 2SC4793
QJ04	23114528	TRANSISTOR, 2SC1740S
QM03	23205057	TRANSISTOR, CHIP 50V 150MA SM KTC3875Y
QR90	23205057	TRANSISTOR, CHIP 50V 150MA SM KTC3875Y
QR91	23205057	TRANSISTOR, CHIP 50V 150MA SM KTC3875Y
QS01	A6359871	TRANSISTOR, 2SC3326B (L)
QS11	A6359871	TRANSISTOR, 2SC3326B (L)
QS12	A6014041	TRANSISTOR, RN2404
QS13	23205057	TRANSISTOR, CHIP 50V 150MA SM KTC3875Y
QS14	23205057	TRANSISTOR, CHIP 50V 150MA SM KTC3875Y
QS101	23318820	IC, OPE-AMP DUAL VCC=32V SOP8 BA10358F
QS102	A6014041	TRANSISTOR, RN2404
QS103	A6359871	TRANSISTOR, 2SC3326B (L)
QS104	A6359871	TRANSISTOR, 2SC3326B (L)
QS107	23904896	IC, JLC1562BF

Location No.	Parts No.	Description
QS108	23205057	TRANSISTOR, CHIP 50V 150MA SM KTC3875Y
QS120	23906597	IC, BA4558F
QV01	B0384761	IC, écété'ék AV SW IC NDIP 54 TA8851CN
QV02	23905590	IC, M52055FP
QV10	23114528	TRANSISTOR, 2SC1740S
QV17	23205057	TRANSISTOR, CHIP 50V 150MA SM KTC3875Y
QV18	23114528	TRANSISTOR, 2SC1740S
QV19	23114499	TRANSISTOR, RN1404(TE85L
QV37	23205054	TRANSISTOR, CHIP -50V -150MA SM KTA1504Y
QV38	23205054	TRANSISTOR, CHIP -50V -150MA SM KTA1504Y
QV39	23205054	TRANSISTOR, CHIP -50V -150MA SM KTA1504Y
QV160	A6004031	TRANSISTOR, RN1403
QV501	23318981	IC, MC14053BF
QV504	23314994	TRANSISTOR, 2SA1576A106
QV505	23314994	TRANSISTOR, 2SA1576A106
QV506	23314994	TRANSISTOR, 2SA1576A106
QV507	23314994	TRANSISTOR, 2SA1576A106
QV508	23314994	TRANSISTOR, 2SA1576A106
QV509	23314994	TRANSISTOR, 2SA1576A106
QV524	23314993	TRANSISTOR, 2SC4081 Q
QW05	23205057	TRANSISTOR, CHIP 50V 150MA SM KTC3875Y
QW08	23205057	TRANSISTOR, CHIP 50V 150MA SM KTC3875Y
QW11	23205057	TRANSISTOR, CHIP 50V 150MA SM KTC3875Y
QX111	23314993	TRANSISTOR, 2SC4081 Q
QX112	23904125	IC, TC4W53FU(T2L
QX113	23314993	TRANSISTOR, 2SC4081 Q
QX121	23314993	TRANSISTOR, 2SC4081 Q
QX122	23904126	IC, L-MOS D-BILATERAL SW. SM8 TC4W66FU
QX123	23314993	TRANSISTOR, 2SC4081 Q
QX131	23314993	TRANSISTOR, 2SC4081 Q
QX133	23314993	TRANSISTOR, 2SC4081 Q
QX141	23314993	TRANSISTOR, 2SC4081 Q
QX143	23314993	TRANSISTOR, 2SC4081 Q
QX151	23314993	TRANSISTOR, 2SC4081 Q
QX153	23314993	TRANSISTOR, 2SC4081 Q
QX161	23314993	TRANSISTOR, 2SC4081 Q
QX163	23314993	TRANSISTOR, 2SC4081 Q
QX170	23000790	IC, ANALOG MPX SSOP32P BH7650FS
QX171	23318026	IC, C-IC +5V REG IO=40MA TA78L05F(TEL
QX201	23314993	TRANSISTOR, 2SC4081 Q
QX202	23314993	TRANSISTOR, 2SC4081 Q
QX206	23314993	TRANSISTOR, 2SC4081 Q
QX207	23000263	IC, CMOS MULTIPLEXER SOP16 BU4053BCF
QX211	23314993	TRANSISTOR, 2SC4081 Q
QX212	23314993	TRANSISTOR, 2SC4081 Q
QX220	23905939	IC, TLC2933IPW
QX221	23318026	IC, C-IC +5V REG IO=40MA TA78L05F(TEL
QX222	23904396	IC, L-MOS SCHMITT INVERTER SMV TC7S14F
QX223	23905927	IC, TC7SH32FU(BRA
QX224	23906951	IC, HCMOS SINGLE OR GATE 5PIN SN74AHCT1G32DCK
QX226	23314994	TRANSISTOR, 2SA1576A106
QX240	23905013	IC, TLC2932IPW
QX242	23904396	IC, L-MOS SCHMITT INVERTER SMV TC7S14F

Location No.	Parts No.	Description
QX243	23905927	IC, TC7SH32FU(BRA
QX244	23906951	IC, HCMOS SINGLE OR GATE 5PIN SN74AHCT1G32DCK
QX245	23318026	IC, C-IC +5V REG I0=40MA TA78L05F(TEL
QX246	23314994	TRANSISTOR, 2SA1576A106
QX260	23905013	IC, TLC2932IPW
QX261	23000283	IC, R1121N331B-T
QX262	23318823	IC, TC7S04F
QX300	23000788	IC, CMOS NEW MVP QFP240P MB87J4731
QX310	23000198	IC, EM636327Q-8
QX330	23000803	IC, +2.5V 2% REG.SC-63 UPC2925T
QX340	23000282	IC, R1121N251B-T
QX341	23314352	TRANSISTOR, IMT2
QX342	23314352	TRANSISTOR, IMT2
QX360	23000283	IC, R1121N331B-T
QX391	23314993	TRANSISTOR, 2SC4081 Q
QX392	23314993	TRANSISTOR, 2SC4081 Q
QX393	23314993	TRANSISTOR, 2SC4081 Q
QX470	70129665	IC, IC-HCT TC74HCT32AF TC74HCT32AF
QX471	23314993	TRANSISTOR, 2SC4081 Q
QX472	23314993	TRANSISTOR, 2SC4081 Q
QX511	23314994	TRANSISTOR, 2SA1576A106
QX521	23314994	TRANSISTOR, 2SA1576A106
QX531	23314994	TRANSISTOR, 2SA1576A106
QX552	23314994	TRANSISTOR, 2SA1576A106
QX562	23314994	TRANSISTOR, 2SA1576A106
QX572	23314994	TRANSISTOR, 2SA1576A106
QY01	B0386049	IC, BUS P/N VCD IC QFP48 TA1270AF(J)
QY10	23314994	TRANSISTOR, 2SA1576A106
QY12	23314994	TRANSISTOR, 2SA1576A106
QY101	23314994	TRANSISTOR, 2SA1576A106
QY116	23314993	TRANSISTOR, 2SC4081 Q
QY213	23205014	TRANSISTOR, HIGH SPEED SWICH 2SC4667-O
QY264	23205057	TRANSISTOR, CHIP 50V 150MA SM KTC3875Y
QY501	23318981	IC, MC14053BF
QY504	23314994	TRANSISTOR, 2SA1576A106
QY505	23314994	TRANSISTOR, 2SA1576A106
QY506	23314994	TRANSISTOR, 2SA1576A106
QY507	23314994	TRANSISTOR, 2SA1576A106
QY508	23314994	TRANSISTOR, 2SA1576A106
QY509	23314994	TRANSISTOR, 2SA1576A106
QY524	23314993	TRANSISTOR, 2SC4081 Q
QY600	23000936	IC, ODD/EVN-HANTEI 032ATC44-10(T
QY615	23904676	IC, L-MOS BILATERAL SW. SSOP5P TC7S66F
QY616	23314993	TRANSISTOR, 2SC4081 Q
QY621	23904396	IC, L-MOS SCHMITT INVERTER SMV TC7S14F
QY622	23904396	IC, L-MOS SCHMITT INVERTER SMV TC7S14F
QY661	23904396	IC, L-MOS SCHMITT INVERTER SMV TC7S14F
QY662	23904396	IC, L-MOS SCHMITT INVERTER SMV TC7S14F
QZ01	23000108	IC, UPD64082
QZ02	23000438	IC, CMOS 4MDRAM EDO 40SOJ M11B416256A-35J
QZ04	23314994	TRANSISTOR, 2SA1576A106
QZ05	23314994	TRANSISTOR, 2SA1576A106
QZ06	23314993	TRANSISTOR, 2SC4081 Q
QZ14	23314994	TRANSISTOR, 2SA1576A106
QZ16	23314993	TRANSISTOR, 2SC4081 Q
QZ17	23314994	TRANSISTOR, 2SA1576A106

Location No.	Parts No.	Description
QZ18	23314993	TRANSISTOR, 2SC4081 Q
QZ20	23314993	TRANSISTOR, 2SC4081 Q
QZ21	23314993	TRANSISTOR, 2SC4081 Q
QZ22	23314993	TRANSISTOR, 2SC4081 Q
QZ23	23314994	TRANSISTOR, 2SA1576A106
QZ24	23314993	TRANSISTOR, 2SC4081 Q
QZ100	23906515	IC, CMOS 2LDIGICOMB SOP16P TC90A45F
QZ101	23314993	TRANSISTOR, 2SC4081 Q
QZ102	23314993	TRANSISTOR, 2SC4081 Q
QZ103	23314994	TRANSISTOR, 2SA1576A106
D101	23316754	DIODE, ZENER, MTZJ33B
D301	23316472	DIODE, RGP10J
D302	23316472	DIODE, RGP10J
D303	23316794	DIODE, SC570A
D312	23118041	DIODE, MA111
D321	23316761	DIODE, ZENER, MTZJ39A
D330	23118041	DIODE, MA111
D335	23316715	DIODE, ZENER, MTZJ11A
D336	23316672	DIODE, ZENER, MTZJ5.6B
D337	23316672	DIODE, ZENER, MTZJ5.6B
D338	23316655	DIODE, ZENER, MTZJ3.0B
D341	23118041	DIODE, MA111
D354	23118859	DIODE, 1SS133
D370	23316672	DIODE, ZENER, MTZJ5.6B
D371	23118859	DIODE, 1SS133
D390	23316651	DIODE, ZENER VZ=2.43-2.63V DO34 MTZ J 2.4B
D395	23316725	DIODE, ZENER, MTZJ15B
D404	23224366	DIODE, FMQ-3GU
D404B	70391355	SCREW, 3X8MM
D406	23316472	DIODE, RGP10J
D408	23316472	DIODE, RGP10J
D410	23118094	DIODE, EU2A
D412	23118094	DIODE, EU2A
D413	23118859	DIODE, 1SS133
D414	23316688	DIODE, ZENER, MTZJ9.1C
D415	23316472	DIODE, RGP10J
D417	23316726	DIODE, ZENER, MTZJ15C
D418	23316726	DIODE, ZENER, MTZJ15C
D419	23316716	DIODE, ZENER, MTZJ11B
D420	23316716	DIODE, ZENER, MTZJ11B
D422	23316591	DIODE, ZENER, MA8100-M
D423	23115532	DIODE, ERB12-01
D424	23357076	DIODE, ZENER VZ=6.52-6.79 HZS6.8N B2
D432	23115532	DIODE, ERB12-01
D467	23118094	DIODE, EU2A
D470	23316758	DIODE, ZENER VZ32.79-34.49 DO34 MTZ J 36B
D471	23316472	DIODE, RGP10J
D475	23316715	DIODE, ZENER, MTZJ11A
D476	23118859	DIODE, 1SS133
D479	23118041	DIODE, MA111
D480	23118859	DIODE, 1SS133
D481	23118859	DIODE, 1SS133
△ D484	23115774	DIODE, ZENER, RD6.2E(FA-1)
D485	23316684	DIODE, ZENER, MTZJ8.2B
D502	23118041	DIODE, MA111
D503	23118041	DIODE, MA111
D505	23316622	DIODE, ZENER, MA8270-M
D520	23316647	DIODE, ZENER, MTZJ2.0B
D601	23118041	DIODE, MA111
D602	23118041	DIODE, MA111
D603	23118041	DIODE, MA111
D604	23118041	DIODE, MA111
D607	23118262	DIODE, RD33M-T1BB

Location No.	Parts No.	Description
D611	23118041	DIODE, MA111
D612	23316557	DIODE, HSM221C
D613	23118041	DIODE, MA111
D614	23118041	DIODE, MA111
D704	23118859	DIODE, 1SS133
D705	23118859	DIODE, 1SS133
D715	23118859	DIODE, 1SS133
D721	23118859	DIODE, 1SS133
D801	23357041	DIODE, LN6SB60-F05
D801B	70391356	SCREW
D835	23118096	DIODE, RK34
D836	23316782	DIODE, ZENER, MTZJ6.2C
D837	23316678	DIODE, ZENER, MTZJ6.8B
D840	23316962	DIODE, S1WBA20
D845	23118859	DIODE, 1SS133
D855	23118859	DIODE, 1SS133
D862	23316472	DIODE, RGP10J
D864	23316813	DIODE, EG1
D873	23316690	DIODE, ZENER, MTZJ10B
D875	23316689	DIODE, ZENER, MTZJ10A
D876	23316747	DIODE, ZENER, MTZJ27C
D879	23316747	DIODE, ZENER, MTZJ27C
D881	23118859	DIODE, 1SS133
D883	23357018	DIODE, VRM=350V IF=2A S-R DO15L RL2
D884	23357018	DIODE, VRM=350V IF=2A S-R DO15L RL2
D885	23316819	DIODE, RU4YX
D886	23316819	DIODE, RU4YX
D892	23316184	DIODE, FML-G12S
D892B	70391355	SCREW, 3X8MM
D893	23316184	DIODE, FML-G12S
D893B	70391355	SCREW, 3X8MM
D895	23118094	DIODE, EU2A
D896	23118094	DIODE, EU2A
D899	24019485	VARISTOR, V1=430V 3500A TNR10V431K
D901	23118859	DIODE, 1SS133
D904	23118859	DIODE, 1SS133
D905	23118859	DIODE, 1SS133
D906	23118859	DIODE, 1SS133
D907	23118859	DIODE, 1SS133
D908	23118859	DIODE, 1SS133
D909	23118859	DIODE, 1SS133
D911	A7568250	DIODE, 1S1834
D921	A7568250	DIODE, 1S1834
D931	23118859	DIODE, 1SS133
D932	23118859	DIODE, 1SS133
D933	23118859	DIODE, 1SS133
D934	23118859	DIODE, 1SS133
D941	23118859	DIODE, 1SS133
D942	23118859	DIODE, 1SS133
D943	23118859	DIODE, 1SS133
D946	23118859	DIODE, 1SS133
D963	23118859	DIODE, 1SS133
D964	23118859	DIODE, 1SS133
D965	23118859	DIODE, 1SS133
D966	23118859	DIODE, 1SS133
D970	23118859	DIODE, 1SS133
D4385	23316680	DIODE, ZENER, MTZJ7.5A
D4386	23118859	DIODE, 1SS133
D4461	23118041	DIODE, MA111
D4818	23316749	DIODE, ZENER, MTZJ30A
D4819	A7801168	SCR, VRRM=400V IT(AV)0.3A
DA02	23316574	DIODE, ZENER CHIP VZ6.05-6.36V MA8062-M
DA11	23118859	DIODE, 1SS133
DA23	23118041	DIODE, MA111

Location No.	Parts No.	Description
DA43	23118041	DIODE, MA111
DA44	23118041	DIODE, MA111
DA45	23118041	DIODE, MA111
DA46	23118041	DIODE, MA111
DA70	23118041	DIODE, MA111
DA170	23316575	DIODE, ZENER CHIP VZ6.24-6.56V MA8062-H
DB01	23358564	LED, LAMP RED SLR-56VC3FPQ
DB03	23358522	DIODE, LED, SIR-56SB3F
DB05	23316675	DIODE, ZENER, MTZJ6.2B
DB30	23118041	DIODE, MA111
DB31	23118041	DIODE, MA111
DB40	23118041	DIODE, MA111
DJ01	23118859	DIODE, 1SS133
DJ02	23316726	DIODE, ZENER, MTZJ15C
DR90	23118041	DIODE, MA111
DS106	23316583	DIODE, ZENER CHIP VZ3.87-4.10V MA8039-H
DS120	23316740	DIODE, ZENER VZ21.52-22.63 DO34 MTZ J 22D
DV01	23316587	DIODE, ZENER CHIP VZ8.58-9.02V MA8091-L
DV02	23316587	DIODE, ZENER CHIP VZ8.58-9.02V MA8091-L
DV03	23316587	DIODE, ZENER CHIP VZ8.58-9.02V MA8091-L
DV07	23316587	DIODE, ZENER CHIP VZ8.58-9.02V MA8091-L
DV08	23316587	DIODE, ZENER CHIP VZ8.58-9.02V MA8091-L
DV09	23316587	DIODE, ZENER CHIP VZ8.58-9.02V MA8091-L
DV11	23316587	DIODE, ZENER CHIP VZ8.58-9.02V MA8091-L
DV13	23316587	DIODE, ZENER CHIP VZ8.58-9.02V MA8091-L
DV17	23316587	DIODE, ZENER CHIP VZ8.58-9.02V MA8091-L
DV18	23316587	DIODE, ZENER CHIP VZ8.58-9.02V MA8091-L
DV121	23316587	DIODE, ZENER CHIP VZ8.58-9.02V MA8091-L
DV161	23316591	DIODE, ZENER, MA8100-M
DV162	23316591	DIODE, ZENER, MA8100-M
DV163	23316591	DIODE, ZENER, MA8100-M
DV164	23316591	DIODE, ZENER, MA8100-M
DV165	23316591	DIODE, ZENER, MA8100-M
DV166	23316591	DIODE, ZENER, MA8100-M
<b>MISCELLANEOUS</b>		
B230	23037312	SCREW
B231	23035412	SCREW
B232	23035312	SCREW
BB13A	23903022	CONNECTOR, BASE B-B 8P 2.5 JST
BB13B	23903022	CONNECTOR, BASE B-B 8P 2.5 JST
BB14A	23713014	BRIDGE PLUG 16P 1.5
BB14B	23713013	BASE SOCKET 16P 1.5
BB160	23368627	CONNECTOR, BRIDGE B-B 8P 2.5JST 08TM-2.5FJ-E
BB16A	23903022	CONNECTOR, BASE B-B 8P 2.5 JST
BB16B	23903022	CONNECTOR, BASE B-B 8P 2.5 JST
BB50A	23713014	BRIDGE PLUG 16P 1.5
BB50B	23713013	BASE SOCKET 16P 1.5
BB60A	23713014	BRIDGE PLUG 16P 1.5
BB60B	23713013	BASE SOCKET 16P 1.5

Location No.	Parts No.	Description
BB70A	23713014	BRIDGE PLUG 16P 1.5
BB70B	23713013	BASE SOCKET 16P 1.5
BB80A	23368517	CONNECTOR, PLUG B-B 6P2.5
BB80B	23902749	CONNECTOR, SOCKET B-B6P2.5
BB130	23368627	CONNECTOR, BRIDGE B-B 8P 2.5JST 08TM-2.5FJ-E
F470	23144849	FUSE, CARTRIDGE 5X20 250V 2.0A
F470A	23165433	FUSE HOLDER, 5.2 SOC
F801	23144745	FUSE, 10.0A UL
F801A	23165433	FUSE HOLDER, 5.2 SOC
F860	23144456	FUSE, AXIAL 125V 5.0A
F889	23144456	FUSE, AXIAL 125V 5.0A
F890	23144456	FUSE, AXIAL 125V 5.0A
F891	23144456	FUSE, AXIAL 125V 5.0A
G101	24011101	CHIP, METAL FILM, 1/20W 100 OHM J
G102	24011101	CHIP, METAL FILM, 1/20W 100 OHM J
G301	24366472	CARBON FILM, 1/6W 4.7K OHM J
G306	24366222	CARBON FILM, 1/6W 2.2K OHM J
G312	24366272	CARBON FILM, 1/6W 2.7K OHM J
G370	24338159	METAL FILM, 1W 1.5 OHM J
G403	24946223	CARBON COMPOSITION GF 1/2W 22K K
G498	24568109	CERAMIC COVERED G 7W 1.0 J
△G883	23316679	DIODE, ZENER, MTZJ6.8C
GJ02	24000445	CHIP JUMPER, 1608TYPE
GJ16	24000445	CHIP JUMPER, 1608TYPE
GJ17	24000445	CHIP JUMPER, 1608TYPE
GJ19	24000445	CHIP JUMPER, 1608TYPE
GJ33	24000445	CHIP JUMPER, 1608TYPE
GJ40	24000445	CHIP JUMPER, 1608TYPE
GJ501	24000445	CHIP JUMPER, 1608TYPE
GJ510	24000445	CHIP JUMPER, 1608TYPE
GJ511	24000445	CHIP JUMPER, 1608TYPE
GJ512	24000445	CHIP JUMPER, 1608TYPE
GJA33	24000445	CHIP JUMPER, 1608TYPE
GR07	24000445	CHIP JUMPER, 1608TYPE
GR14	24000445	CHIP JUMPER, 1608TYPE
GR15	24000445	CHIP JUMPER, 1608TYPE
GR16	24000445	CHIP JUMPER, 1608TYPE
GR17	24000445	CHIP JUMPER, 1608TYPE
GR20	24000445	CHIP JUMPER, 1608TYPE
GR21	24000445	CHIP JUMPER, 1608TYPE
GR24	24000445	CHIP JUMPER, 1608TYPE
GR49	24000445	CHIP JUMPER, 1608TYPE
GR50	24000445	CHIP JUMPER, 1608TYPE
GR82	24000445	CHIP JUMPER, 1608TYPE
GR83	24000445	CHIP JUMPER, 1608TYPE
GR84	24000445	CHIP JUMPER, 1608TYPE
GR85	24000445	CHIP JUMPER, 1608TYPE
GR90	24000445	CHIP JUMPER, 1608TYPE
GR107	24000445	CHIP JUMPER, 1608TYPE
JM03	24000445	CHIP JUMPER, 1608TYPE
JM04	24000445	CHIP JUMPER, 1608TYPE
JM06	24000445	CHIP JUMPER, 1608TYPE
JM07	24000445	CHIP JUMPER, 1608TYPE
JR02	24000445	CHIP JUMPER, 1608TYPE
JV504	24000445	CHIP JUMPER, 1608TYPE
JX206	24000445	CHIP JUMPER, 1608TYPE
JX207	24000445	CHIP JUMPER, 1608TYPE
JX216	24000445	CHIP JUMPER, 1608TYPE
JX217	24000445	CHIP JUMPER, 1608TYPE
JX551	24000445	CHIP JUMPER, 1608TYPE
JX553	24000445	CHIP JUMPER, 1608TYPE
JX561	24000445	CHIP JUMPER, 1608TYPE
JX563	24000445	CHIP JUMPER, 1608TYPE
JX571	24000445	CHIP JUMPER, 1608TYPE

Location No.	Parts No.	Description
JX573	24000445	CHIP JUMPER, 1608TYPE
JY22	24000445	CHIP JUMPER, 1608TYPE
JY27	24000445	CHIP JUMPER, 1608TYPE
JY303	24000576	JUMPER CHIP, 3216TYPE
JY504	24000445	CHIP JUMPER, 1608TYPE
JZ01	24000445	CHIP JUMPER, 1608TYPE
JZ02	24000576	JUMPER CHIP, 3216TYPE
JZ03	24000445	CHIP JUMPER, 1608TYPE
KB01	23906805	IC, REMOTE PHOTO RECIEVER PIC-TB17
M461A	23192945	ANODECAP ASSEMBLY, TCCP5162
M461B	23505090	CABLE, CABLE FOCUS
M461C	23505089	CABLE, CABLE FOCUS
M461D	23504719	CABLE, CABLE SCREEN
N421	23969041	TAPE WHITE 3M #1, W=1 INCH TNP COMMON
P311A	23902863	SOCKET, B-B, 20P 2MM SMK
P311B	23368520	CONNECTOR, 20P, 2MM
P312A	23902863	SOCKET, B-B, 20P 2MM SMK
P312B	23368520	CONNECTOR, 20P, 2MM
P801	23372113	POWER CORD, U/C 125V10A HSV 2 CMC-02P 1
PV01	23365274	JACK, PIN JACK 2S6P 2S6P
PV02	23365819	JACK, 1S3P, 1S+PIN(1E+1L+1R)
PV03	23365949	JACK, 5P, 1E:OFF+2R:OFF+2L:OFF, JALC
PV04	23365949	JACK, 5P, 1E:OFF+2R:OFF+2L:OFF, JALC
PV08	23365273	JACK, JACK, PIN 6P JACK 6P
PV12	23903040	SOCKET, B-B 2MM 56P TAIKO
PZ01	23368646	PLUG, B-B 2MM 56P TAIKO
S602	23145409	SWITCH
SA01	23145227	SWITCH, PUSH, 1C1P
SA02	23145227	SWITCH, PUSH, 1C1P
SA03	23145227	SWITCH, PUSH, 1C1P
SA04	23145227	SWITCH, PUSH, 1C1P
SA05	23145227	SWITCH, PUSH, 1C1P
SA06	23145227	SWITCH, PUSH, 1C1P
SA07	23145227	SWITCH, PUSH, 1C1P
SA08	23145227	SWITCH, PUSH, 1C1P
SJ01	23146958	RELAY, 2C 1A DC12V OMRON
SR42	23146558	RELAY, DC12V SILENT DJ12D1-O(M)-Q
SR81	23146577	RELAY, DLS5D1-O(M)0.25W DLS5D1-O(M)0.
SR83	23146564	RELAY, DC12V, TV5, DG-3
W661	23351038	SPEAKER, SPK1311, 60X120,8 OHM,10W
W662	23351038	SPEAKER, SPK1311, 60X120,8 OHM,10W
W665	23351133	SPEAKER, SPK1392, 100X100 60HM 16W
X401	23153721	CERAMIC RESONATOR, 503KHZ
X501	23153961	CRYSTAL, 3.58MHZ
XA01	23153533	CERAMIC RESONATOR, CERA RESO TCR1082AM
XY01	23153961	CRYSTAL, 3.58MHZ
XY03	23153721	CERAMIC RESONATOR, 503KHZ
X4401	23153721	CERAMIC RESONATOR, 503KHZ
X4402	23153721	CERAMIC RESONATOR, 503KHZ
Z301	23110845	CAPACITOR, RECTI.CIRCUIT BLOCK TPA6032BH
Z401	23140203	SPARK GAP, 2.0-3.0KV C-010 AG20PC152F-L3N
ZX821	23246195	COIL, CHIP INDUCTOR, TRF41R0CG
ZX822	23246195	COIL, CHIP INDUCTOR, TRF41R0CG
ZX823	23246195	COIL, CHIP INDUCTOR, TRF41R0CG
<b>PC BOARD ASSEMBLIES</b>		
* U801	23786377	POW/DEF BOARD, PD0159A (36HFX71)
* U801	23786388	POW/DEF BOARD, PD0159B (32HFX71)
* U802	23786378	AC INPUT BOARD, PD0161
* U803	23786379	LOWB/VERT BOARD, PB9567A (36HFX71)



Location No.	Parts No.	Description
* U803	23786789	LOWB/VERT BOARD, PB9567B (32HFX71)
* U901	23786790	CRT/D VM BOARD, PD0164A (36HFX71)
* U901	23786381	CRT/D VM BOARD, PD0164B (32HFX71)
* U902	23786380	SIGNAL BOARD, PD0162A
* UA01	23786956	CONT-1 BOARD, PB9570B (36HFX71)
* UA01	23786957	CONT-1 BOARD, PB9699A (32HFX71)
* UA02	23785948	CONT-2 BOARD, PB9571B (36HFX71)
* UA02	23785391	CONT-2 BOARD, PB9700 (32HFX71)
* UD01	23786625	WOW BOARD, PD0220B
* UZ01	23786382	NEXT HYPER BOARD, PD0264B
<b>PICTURE TUBE</b>		
△ V901	23312929	ITC36VPF LH0.22LV11 TDD A90AJZ90X30 (36HFX71)
△ V901	23312931	PICTURE TUBE, A80ERF031X64
<b>TUNER</b>		
H001	23321411	TUNER, TIM 181CH IIC PH SHINSEN EL967LW
HY01	23321412	TUNER, TIF 181CH IIC PH TDL EL963L
<b>ACCESSORIES</b>		
K912	23306370	REMOCON HAND UNIT IR, CTVUSA CT-90047
Y101	23565306	OWNER'S MANUAL, ENGLISH
Y101F	23565307	OWNER'S MANUAL, FRENCH
<b>CABINET PARTS</b>		
A201	23540706	FRONT COVER ASSY 36HFX71
A211	23540659	FRONT COVER (32HFX71)
A213	23427977	DOOR, DOOR 36AFX61
A214	23451976	PUSH CATCH, CLICK
A224	23445521	BUTTON, BUTTON 36AFX61
A411	23540212	COVER, B/C PROPER (36HFX71)
A411	23540031	COVER, B/C PROPER (32HFX71)
A701	23946097	PACKING, CARTON 36HFX70
A703	23946094	PACKING, TOP PACKING 36HFX70
A708	23946095	PACKING, BOTTOM PACKING 36HFX70

Location No.	Parts No.	Description
--------------	-----------	-------------

**THIS PAGE IS  
INTENTIONALLY LEFT  
BLANK.**



POWER/DEF BOARD PD0159  
BOTTOM (FOIL) SIDE

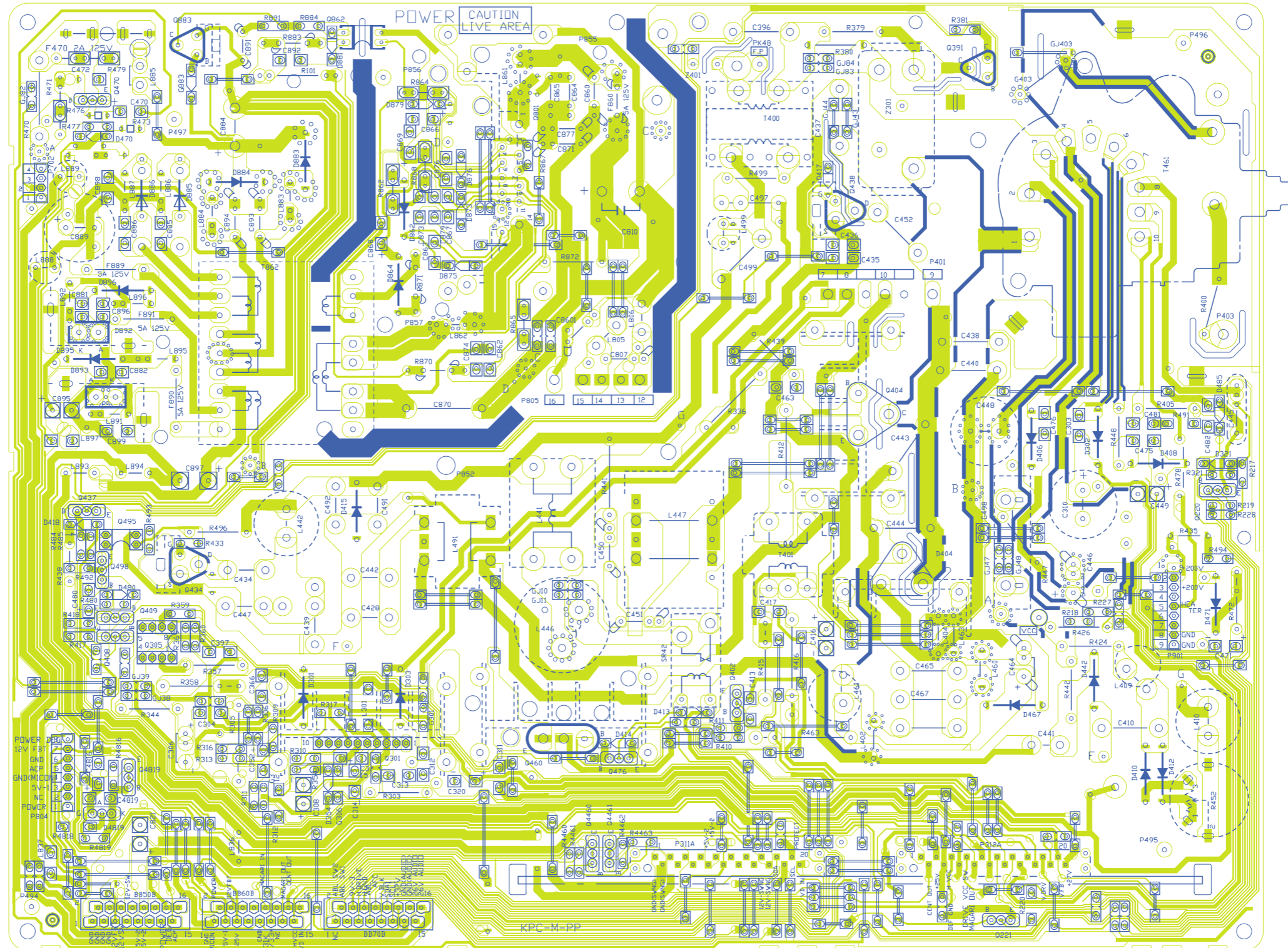





# CONTROL-1 BOARD PB9570

## BOTTOM (FOIL) SIDE

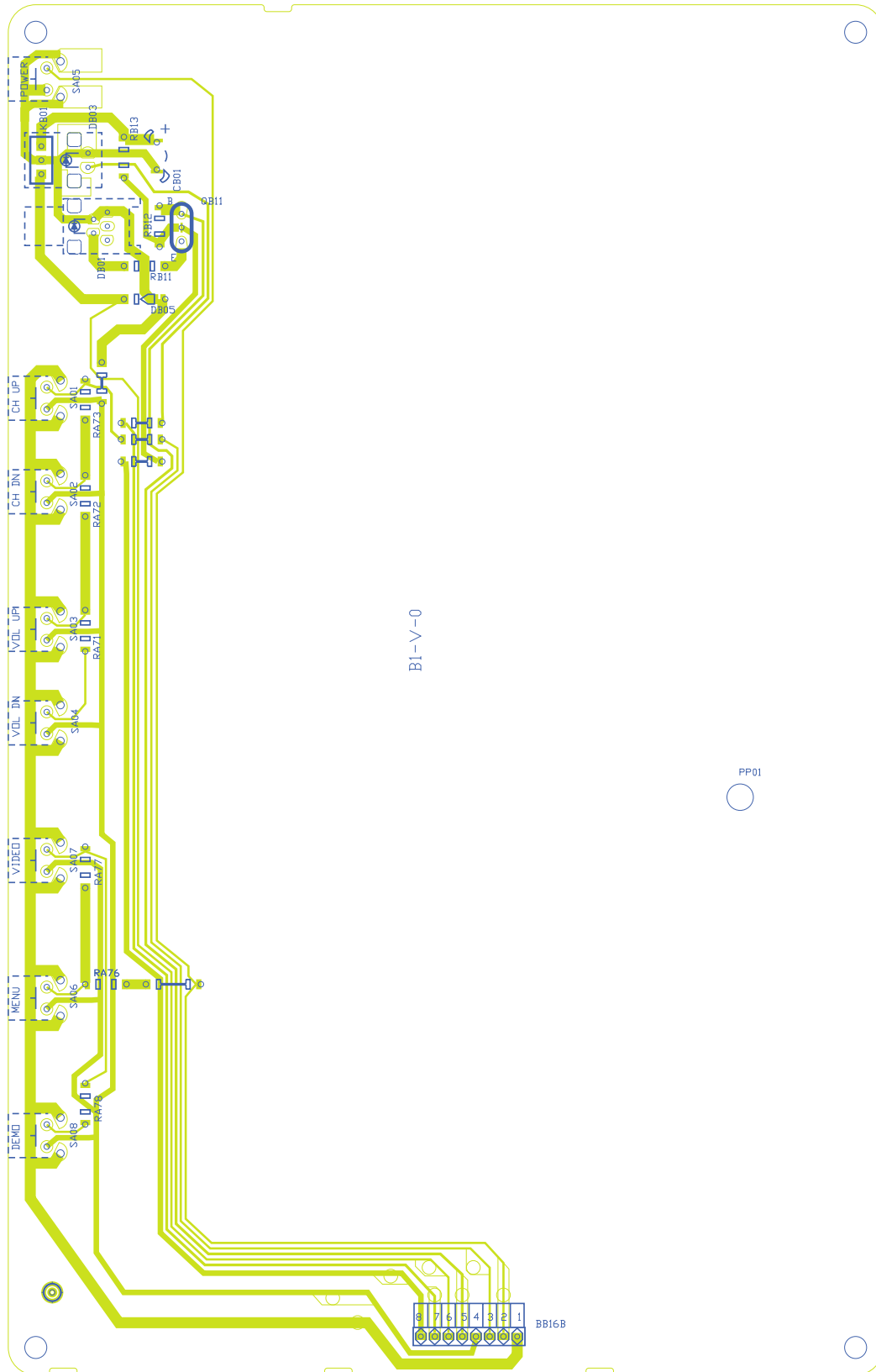

# CONTROL-2 BOARD PB9571

## BOTTOM (FOIL) SIDE

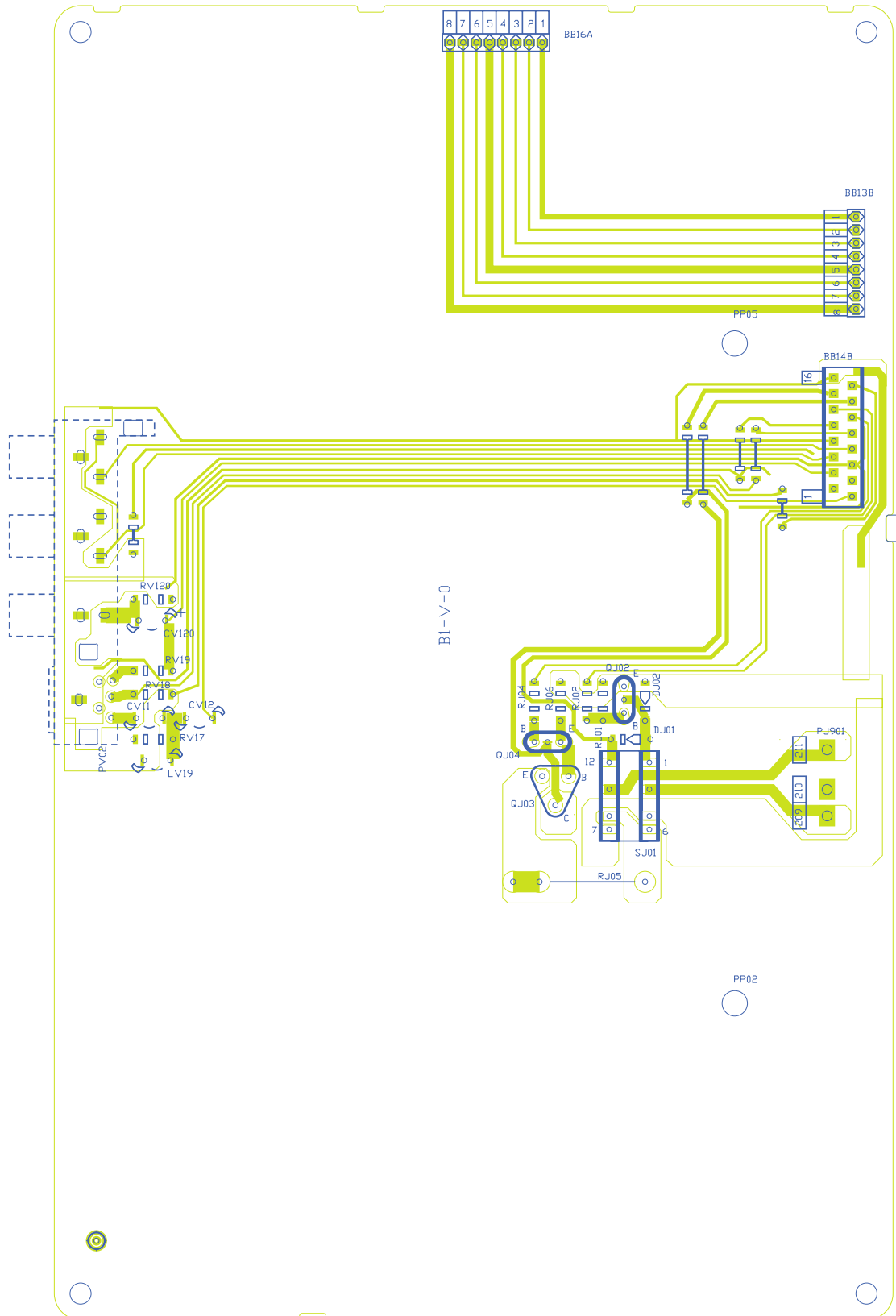



WOW BOARD PD0220  
BOTTOM (FOIL) SIDE

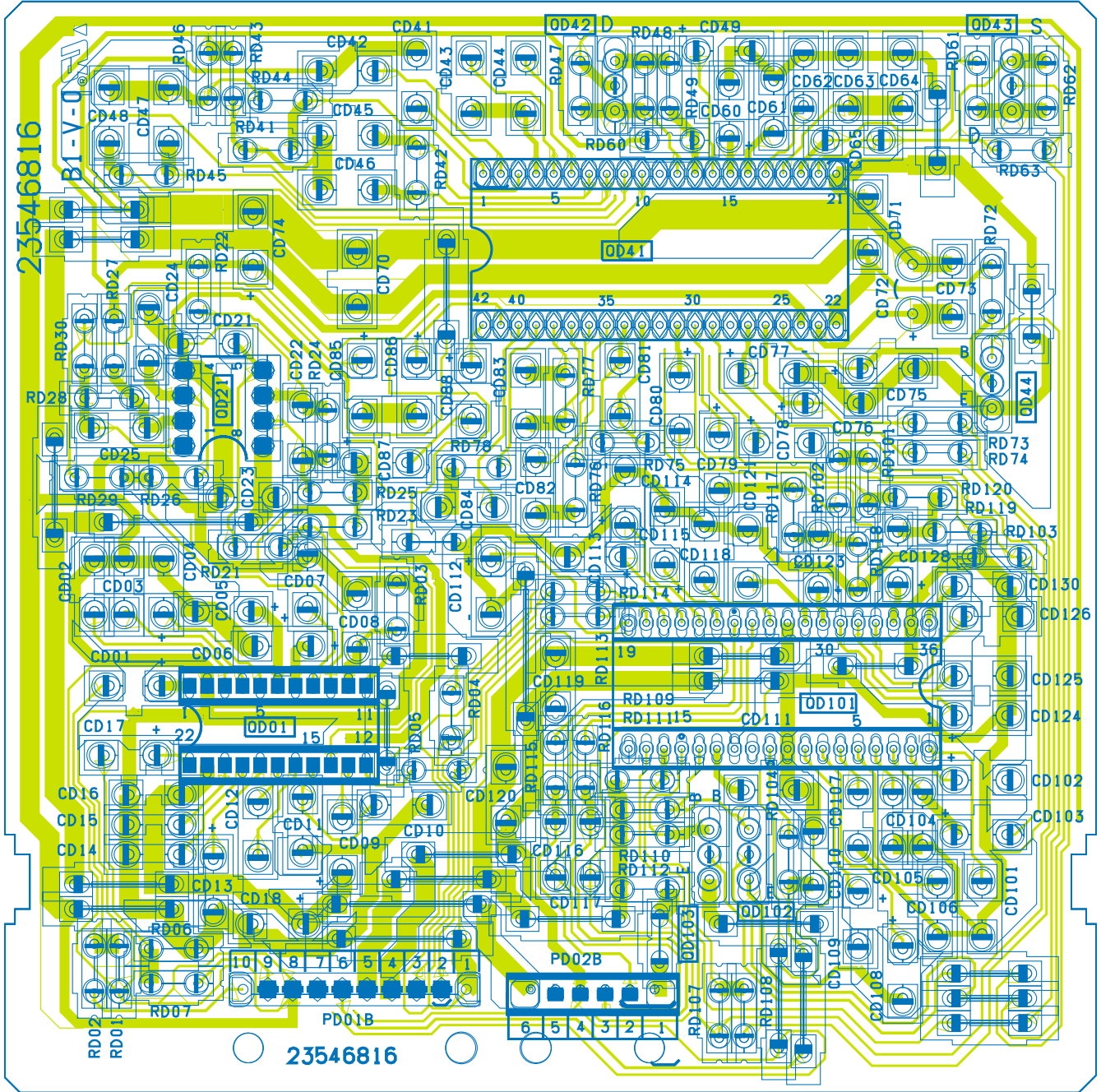



# TERMINAL VIEW OF TRANSISTORS

- ① 2SD2253  
(old)  
2SC5243

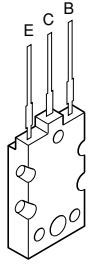

- ② 2SC3852  
2SD1763A  
2SC1569  
2SC4544  
2SA1788  
2SA1306  
2SA1186A

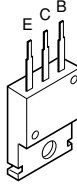

- ③ 2SC752GTM  
2SC2482  
2SC2655  
2SC4721P



- ④ 2SC752  
2SA562TM  
2SA1015  
2SC1815  
2SC2878  
2SC1740S  
2SC2120  
2SA9335

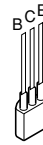

- ⑤ 2SA1788

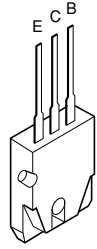

- ⑥ RN2203  
RN2201  
RN2004  
RN1203  
RN1204  
RN2204  
RN1205  
RN1202  
RN1201

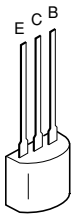

- ⑦ 2SD1554  
2SD2253  
2SD1556  
2SC5143  
2SC5570  
2SD2553

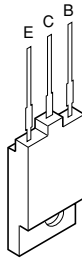

- ⑧ ON4409

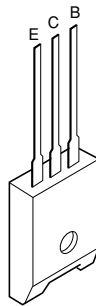



<b>SPECIFICATIONS(Representative: 36HFX71)</b>	
TELEVISION SYSTEM	NTSC standard
CHANNEL COVERAGE	VHF: 2 through 13 UHF: 14 through 69 Cable TV: mid band (A-8 through A-1, A through I) super band (J through W) hyper band (AA through ZZ, AAA, BBB) ultra band (65 through 94, 100 through 125)
POWER SOURCE	120V AC, 60Hz
POWER CONSUMPTION	176 W (average)
AUDIO POWER	10W + 10W, 13 W (Sub-woofer)
SPEAKER TYPE	Two 2-3/8 x 4-3/4 inches (60 x 120mm), one 4 inches (10cm)
VIDEO/AUDIO TERMINALS	S-VIDEO INPUT Y: 1V(p-p), 75 ohm, negative sync. C: 0.286V(p-p) (burst signal), 75 ohm VIDEO/AUDIO INPUT VIDEO: 1V(p-p), 75 ohm, negative sync. AUDIO: 150mV(rms) (30% modulation equivalent, 47k ohm) ColorStream™ (Component video) INPUT Y: 1V (p-p), 75 ohm P <sub>B</sub> : 0.7 V (p-p), 75 ohm P <sub>R</sub> : 0.7 V (p-p), 75 ohm AUDIO: 150 mV (rms) 47k ohm VIDEO/AUDIO OUT PUT VIDEO: 1 V (p-p), 75 ohm, negative sync. AUDIO: 150 mV (rms) (30% modulation equivalent, 4.7k ohm) VARIABLE AUDIO OUTPUT 0-300mV(rms) (30% modulation equivalent, 4.7k ohm) AUDIO CENTER CHANNEL INPUT 300mV(rms) (30% modulation equivalent, 10k ohm)
DIMENSIONS	Width ..... 38-1/4 inches (972 mm) Height ..... 29-5/8 inches (753 mm) Depth ..... 24-1/4 inches (615 mm)
MASS	214 lbs (97.0 kg)
SUPPLIED ACCESORIES	Remote Control with 2 "AA" size alkaline batteries

\* Please refer to owner's manual in detail.

TOSHIBA CORPORATION  
1-1, SHIBAURA 1-CHOME, MINATO-KU, TOKYO 105-8001, JAPAN