

## Low Capacitance Quad Array for ESD Protection

### Features

- Ultra low leakage: nA level
- Operating voltage: 5V
- Low clamping voltage
- Complies with following standards:
  - IEC 61000-4-2 (ESD) immunity test
    - Air discharge:  $\pm 30\text{kV}$
    - Contact discharge:  $\pm 25\text{kV}$
  - IEC61000-4-5 (Lightning) 6A (8/20 $\mu\text{s}$ )
- RoHS Compliant

### Dimensions SOT-353

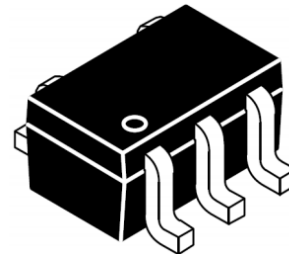

### Applications

- Computers
- Printers
- Communication systems
- Cellular phones handsets and accessories
- Wireline and wireless telephone sets
- Set top boxes

### Pin Configuration

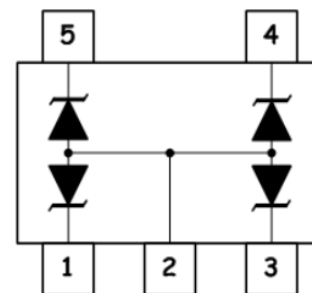

### Mechanical Characteristics

- Package: SOT-353
- Lead Finish: Lead Free
- UL Flammability Classification Rating 94V-0
- Quantity Per Reel: 3,000 pcs
- Reel Size: 7 inch
- Device Marking: WE

### Absolute Maximum Ratings (T<sub>amb</sub>=25°C unless otherwise specified)

Parameter	Symbol	Value	Unit
Peak Pulse Power (8/20 $\mu\text{s}$ )	P <sub>pp</sub>	150	W
ESD per IEC 61000-4-2 (Air)	V <sub>ESD</sub>	$\pm 30$	Kv
ESD per IEC 61000-4-2 (Contact)		$\pm 25$	
Operating Temperature Range	T <sub>J</sub>	-40 to +125	°C
Storage Temperature Range	T <sub>STJ</sub>	-40 to +125	°C

**Electrical Characteristics** (TA=25°C unless otherwise specified)

Parameter	Symbol	Test Condition	Min	Typ	Max	Unit
Reverse Working Voltage	$V_{RWM}$			5		V
Breakdown Voltage	$V_{BR}$	$I_T = 1\text{mA}$	6.1	6.7	7.2	V
Reverse Leakage Current	$I_R$	$V_{RWM} = 5\text{V}$			1	$\mu\text{A}$
Clamping Voltage	$V_C$	$I_{PP} = 1\text{A}$ (8 x 20 $\mu\text{s}$ pulse)		10	15	V
Clamping Voltage	$V_C$	$I_{PP} = 6\text{A}$ (8 x 20 $\mu\text{s}$ pulse)		13.5	20	V
Junction Capacitance	$C_J$	$V_R = 0\text{V}$ , $f = 1\text{MHz}$		90		pF

# Characteristic Curves

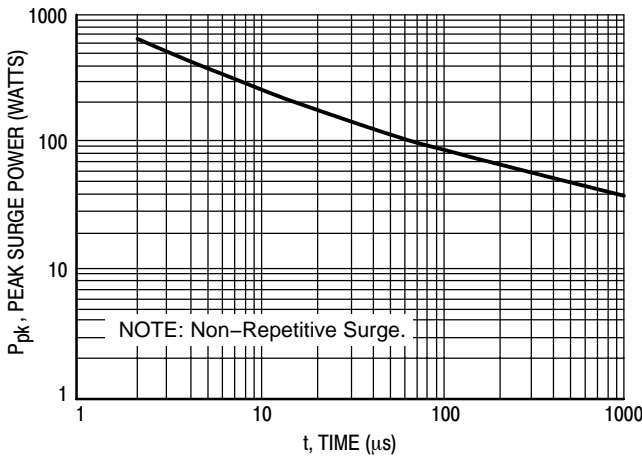

Figure 1. Pulse Width

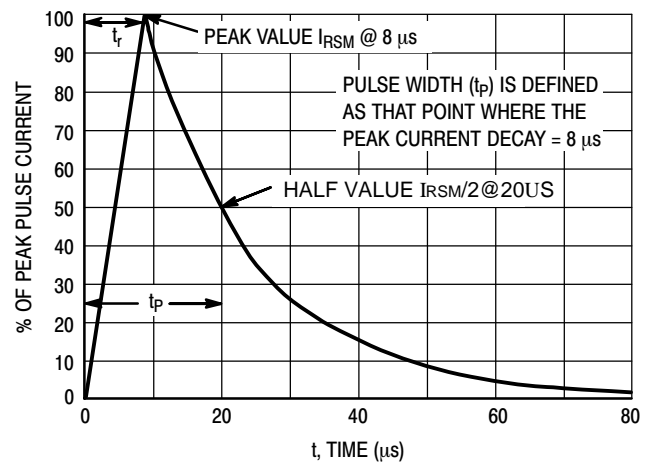

Figure 2. 8 x 20  $\mu$ s Pulse Waveform

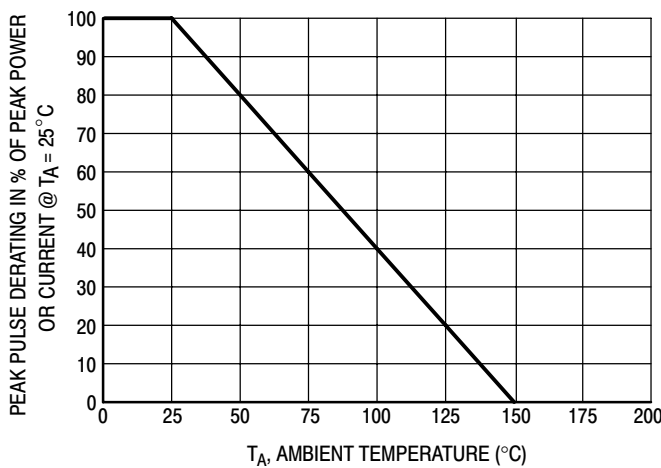

Figure 3. Pulse Derating Curve

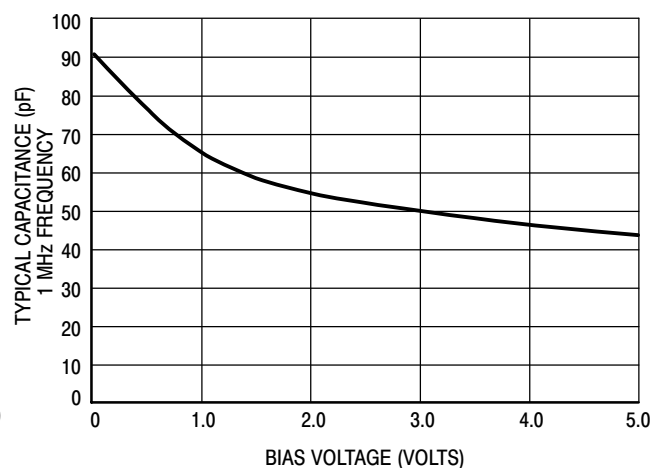

Figure 4. Capacitance

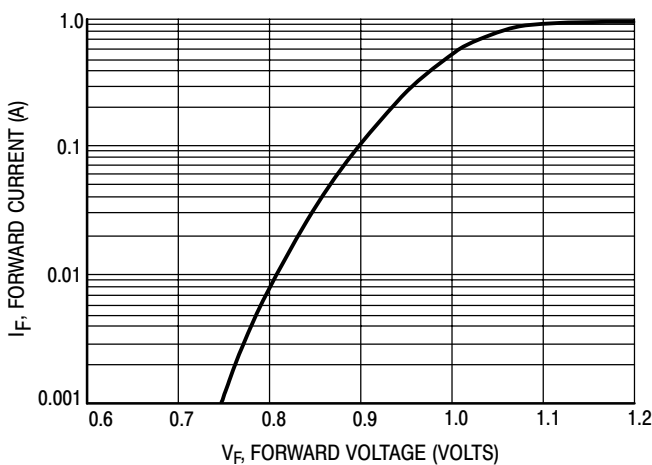

Figure 5. Forward Voltage

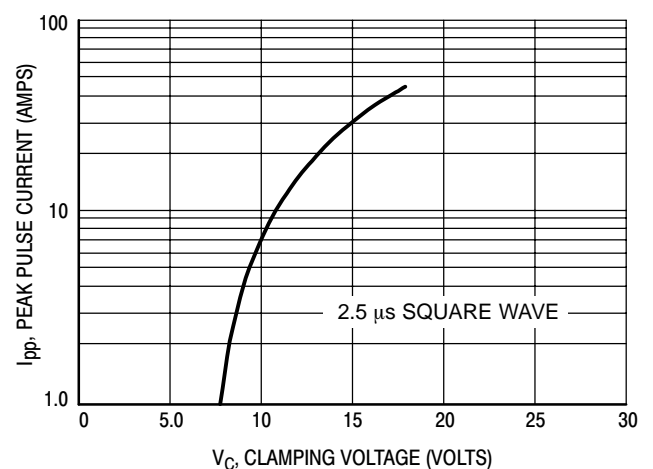
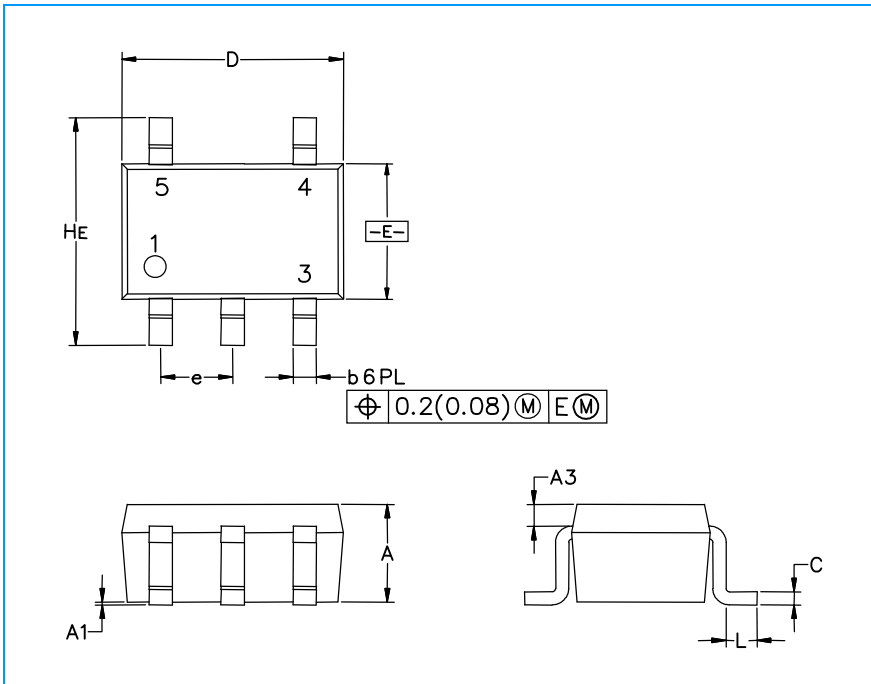

Figure 6. Clamping Voltage versus Peak Pulse Current (Reverse Direction)

## SOT-353 Package Outline & Dimensions



Symbol	Inches			Millimeters		
	Min.	Nom.	Max.	Min.	Nom.	Max.
A	0.031	0.037	0.043	0.80	0.95	1.10
A1	0.000	0.002	0.004	0.00	0.05	0.10
A3	0.08 REF			0.2 REF		
b	0.004	0.008	0.012	0.10	0.21	0.30
C	0.004	0.005	0.010	0.10	0.14	0.25
D	0.070	0.078	0.086	1.80	2.00	2.20
E	0.045	0.049	0.053	1.15	1.25	1.35
e	0.026 BSC			0.65 BSC		
L	0.004	0.008	0.012	0.10	0.20	0.30
H <sub>E</sub>	0.078	0.082	0.086	2.00	2.10	2.20

### Soldering Footprint

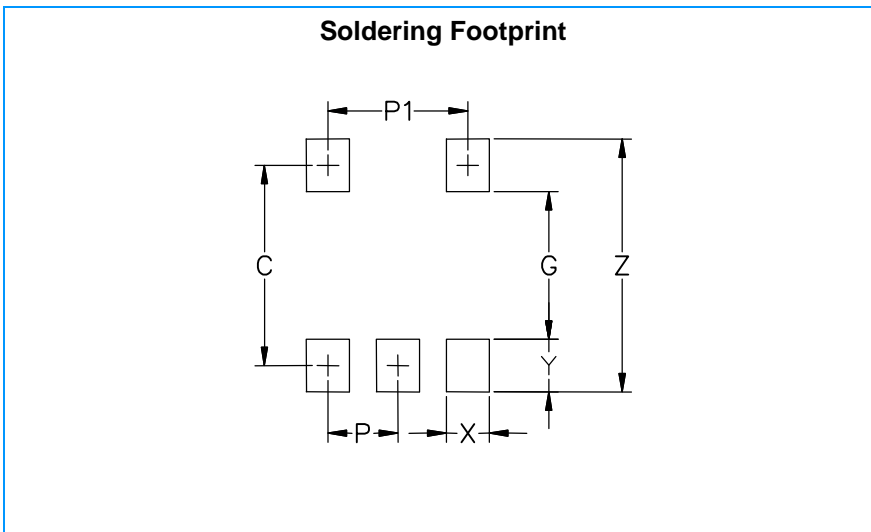

Symbol	Inches	Millimeters
C	0.0748	1.9
G	0.055	1.40
P	0.025	0.65
P1	0.051	1.30
X	0.0157	0.40
Y	0.019	0.50
Z	0.0945	2.4