

Automotive fully integrated H-bridge motor driver

Features

Type	$R_{DS(on)}$	I_{out}	V_{CCmax}
VNH2SP30-E	19m Ω max (per leg)	30A	41V

- 5V logic level compatible inputs
- Undervoltage and overvoltage shut-down
- Overvoltage clamp
- Thermal shut down
- Cross-conduction protection
- Linear current limiter
- Very low stand-by power consumption
- PWM operation up to 20 kHz
- Protection against loss of ground and loss of V_{CC}
- Current sense output proportional to motor current
- Package: ECOPACK[®]

Description

The VNH2SP30-E is a full bridge motor driver intended for a wide range of automotive applications. The device incorporates a dual monolithic high side driver and two low side switches. The high side driver switch is designed using STMicroelectronic's well known and proven proprietary VIPower[™] M0 technology which permits efficient integration on the same die of a true Power MOSFET with an intelligent signal/protection circuitry.

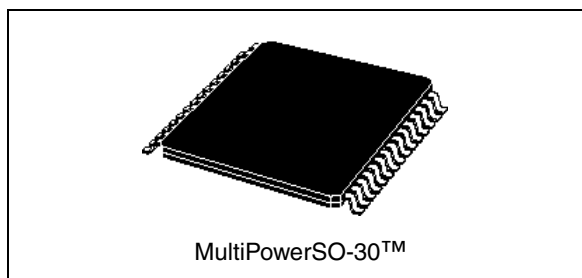

The low side switches are vertical MOSFETs manufactured using STMicroelectronic's proprietary EHD ('STripFET[™]') process. The three die are assembled in the MultiPowerSO-30 package on electrically isolated leadframes. This package, specifically designed for the harsh automotive environment offers improved thermal performance thanks to exposed die pads. Moreover, its fully symmetrical mechanical design allows superior manufacturability at board level. The input signals IN_A and IN_B can directly interface to the microcontroller to select the motor direction and the brake condition. The $DIAG_A/EN_A$ or $DIAG_B/EN_B$, when connected to an external pull-up resistor, enable one leg of the bridge. They also provide a feedback digital diagnostic signal. The normal condition operation is explained in [Table 12: Truth table in normal operating conditions on page 14](#). The motor current can be monitored with the CS pin by delivering a current proportional to its value. The speed of the motor can be controlled in all possible conditions by the PWM up to 20 kHz. In all cases, a low level state on the PWM pin will turn off both the LS_A and LS_B switches. When PWM rises to a high level, LS_A or LS_B turn on again depending on the input pin state.

Table 1. Device summary

Package	Order codes	
	Tube	Tape and Reel
MultiPowerSO-30	VNH2SP30-E	VNH2SP30TR-E

Contents

- 1 Block diagram and pin description 5**

- 2 Electrical specifications 8**
 - 2.1 Absolute maximum ratings 8
 - 2.2 Electrical characteristics 9
 - 2.3 Electrical characteristics curves 16

- 3 Application information 20**
 - 3.1 Reverse battery protection 21

- 4 Package and PCB thermal data 25**
 - 4.1 PowerSSO-30 thermal data 25
 - 4.1.1 Thermal calculation in clockwise and anti-clockwise operation in steady-state mode 26
 - 4.1.2 Thermal resistances definition (values according to the PCB heatsink area) 26
 - 4.1.3 Thermal calculation in transient mode 26
 - 4.1.4 Single pulse thermal impedance definition (values according to the PCB heatsink area) 26

- 5 Package and packing information 29**
 - 5.1 ECOPACK® packages 29
 - 5.2 MultiPowerSO-30 package mechanical data 29
 - 5.3 Packing information 31

- 6 Revision history 32**

List of tables

Table 1.	Device summary	1
Table 2.	Block description	5
Table 3.	Pin definitions and functions	6
Table 4.	Pin functions description	7
Table 5.	Absolute maximum ratings	8
Table 6.	Power section	9
Table 7.	Logic inputs (INA, INB, ENA, ENB)	9
Table 8.	PWM	10
Table 9.	Switching ($V_{CC} = 13V$, $R_{LOAD} = 0.87W$, unless otherwise specified)	10
Table 10.	Protection and diagnostic	10
Table 11.	Current sense ($9V < V_{CC} < 16V$)	11
Table 12.	Truth table in normal operating conditions	14
Table 13.	Truth table in fault conditions (detected on OUTA)	14
Table 14.	Electrical transient requirements	15
Table 15.	Thermal calculation in clockwise and anti-clockwise operation in steady-state mode	26
Table 16.	Thermal parameters	28
Table 17.	MultiPowerSO-30 mechanical data	30
Table 18.	Document revision history	32

List of figures

Figure 1.	Block diagram	5
Figure 2.	Configuration diagram (top view)	6
Figure 3.	Current and voltage conventions	8
Figure 4.	Definition of the delay times measurement	11
Figure 5.	Definition of the low side switching times	12
Figure 6.	Definition of the high side switching times	12
Figure 7.	Definition of dynamic cross conduction current during a PWM operation.	13
Figure 8.	On state supply current.	16
Figure 9.	Off state supply current.	16
Figure 10.	High level input current.	16
Figure 11.	Input clamp voltage.	16
Figure 12.	Input high level voltage	16
Figure 13.	Input low level voltage	16
Figure 14.	Input hysteresis voltage	17
Figure 15.	High level enable pin current	17
Figure 16.	Delay time during change of operation mode	17
Figure 17.	Enable clamp voltage	17
Figure 18.	High level enable voltage	17
Figure 19.	Low level enable voltage	17
Figure 20.	PWM high level voltage	18
Figure 21.	PWM low level voltage	18
Figure 22.	PWM high level current.	18
Figure 23.	Overshoot shutdown	18
Figure 24.	Undervoltage shutdown	18
Figure 25.	Current limitation.	18
Figure 26.	On state high side resistance vs Tcase	19
Figure 27.	On state low side resistance vs Tcase	19
Figure 28.	Turn-On delay time	19
Figure 29.	Turn-Off delay time	19
Figure 30.	Output voltage rise time	19
Figure 31.	Output voltage fall time	19
Figure 32.	Typical application circuit for DC to 20 kHz PWM operation short circuit protection	20
Figure 33.	Behavior in fault condition (How a fault can be cleared).	21
Figure 34.	Half-bridge configuration.	22
Figure 35.	Multi-motors configuration	22
Figure 36.	Waveforms in full bridge operation	23
Figure 37.	Waveforms in full bridge operation (continued)	24
Figure 38.	MultiPowerSO-30™ PC board	25
Figure 39.	Chipset configuration	25
Figure 40.	Auto and mutual Rthj-amb vs PCB copper area in open box free air condition	25
Figure 41.	MultiPowerSO-30 HSD thermal impedance junction ambient single pulse	27
Figure 42.	MultiPowerSO-30 LSD thermal impedance junction ambient single pulse	27
Figure 43.	Thermal fitting model of an H-bridge in MultiPowerSO-30	28
Figure 44.	MultiPowerSO-30 package outline	29
Figure 45.	MultiPowerSO-30 suggested pad layout	30
Figure 46.	MultiPowerSO-30 tube shipment (no suffix)	31
Figure 47.	MultiPowerSO-30 tape and reel shipment (suffix "TR")	31

1 Block diagram and pin description

Figure 1. Block diagram

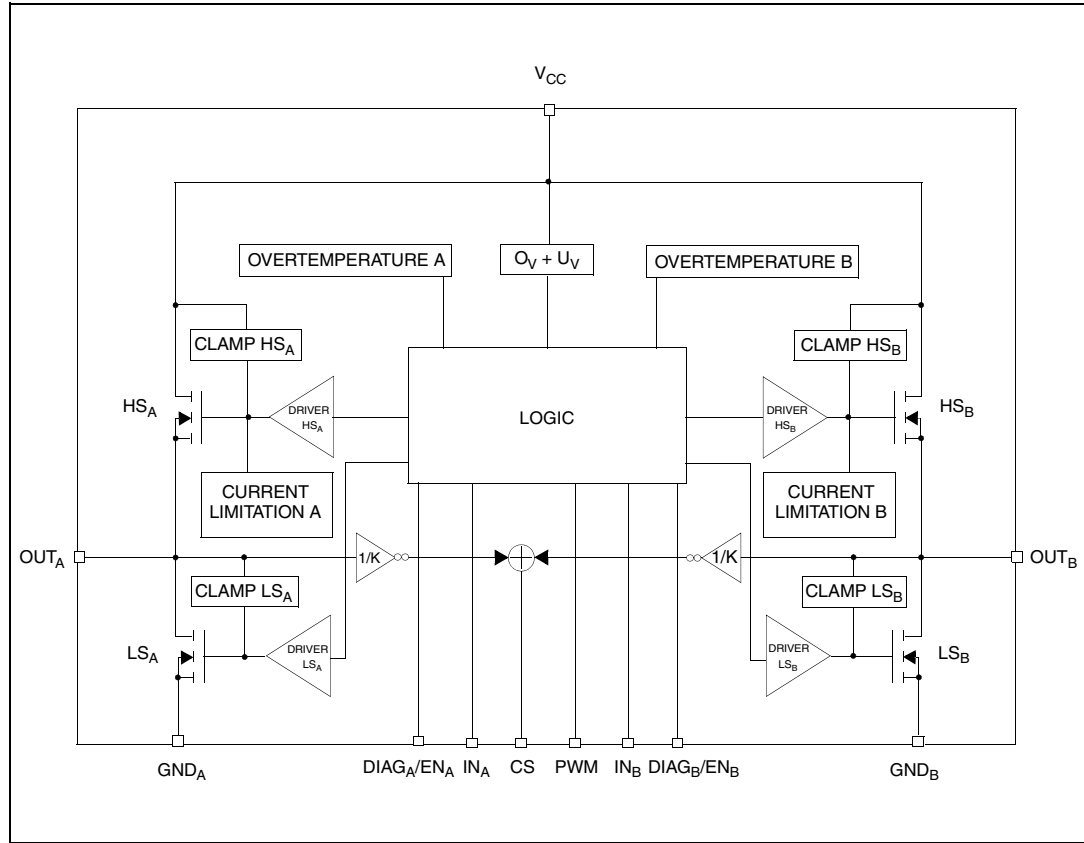

Table 2. Block description

Name	Description
Logic control	Allows the turn-on and the turn-off of the high side and the low side switches according to the truth table
Overvoltage + undervoltage	Shuts down the device outside the range [5.5V..16V] for the battery voltage
High side and low side clamp voltage	Protects the high side and the low side switches from the high voltage on the battery line in all configurations for the motor
High side and low side driver	Drives the gate of the concerned switch to allow a proper $R_{DS(on)}$ for the leg of the bridge
Linear current limiter	Limits the motor current by reducing the high side switch gate-source voltage when short-circuit to ground occurs
Overtemperature protection	In case of short-circuit with the increase of the junction's temperature, shuts down the concerned high side to prevent its degradation and to protect the die
Fault detection	Signals an abnormal behavior of the switches in the half-bridge A or B by pulling low the concerned EN_x /DIAG _x pin

Figure 2. Configuration diagram (top view)

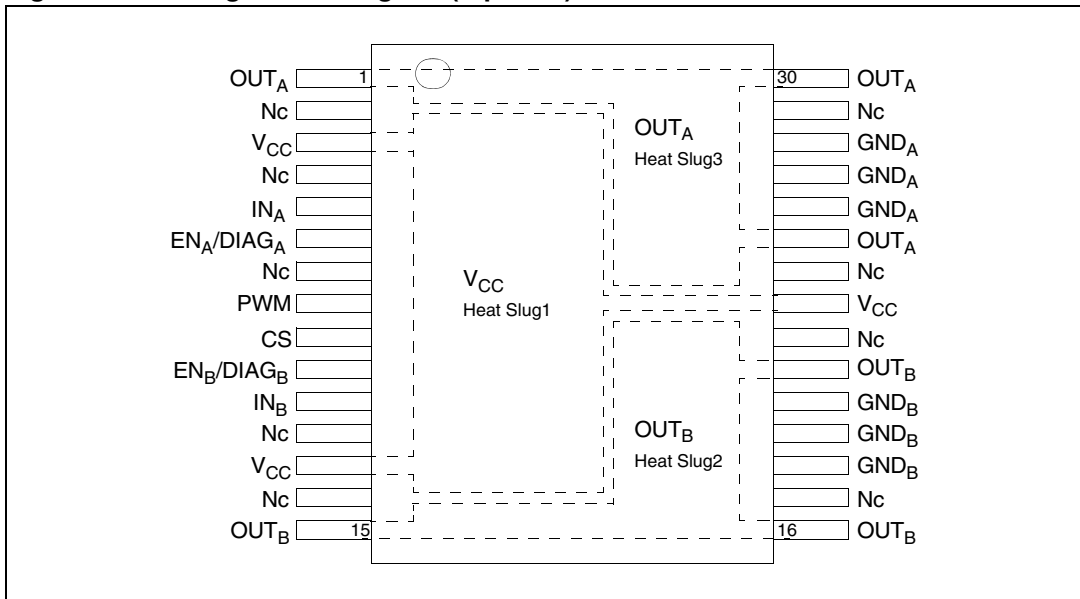

Table 3. Pin definitions and functions

Pin No	Symbol	Function
1, 25, 30	OUT _A , Heat Slug3	Source of high side switch A / Drain of low side switch A
2, 4, 7, 12, 14, 17, 22, 24, 29	NC	Not connected
3, 13, 23	V _{CC} , Heat Slug1	Drain of high side switches and power supply voltage
6	EN _A /DIAG _A	Status of high side and low side switches A; open drain output
5	IN _A	Clockwise input
8	PWM	PWM input
9	CS	Output of current sense
11	IN _B	Counter clockwise input
10	EN _B /DIAG _B	Status of high side and low side switches B; open drain output
15, 16, 21	OUT _B , Heat Slug2	Source of high side switch B / Drain of low side switch B
26, 27, 28	GND _A	Source of low side switch A ⁽¹⁾
18, 19, 20	GND _B	Source of low side switch B ⁽¹⁾

1. GND_A and GND_B must be externally connected together.

Table 4. Pin functions description

Name	Description
V_{CC}	Battery connection
GND_A, GND_B	Power grounds; must always be externally connected together
OUT_A, OUT_B	Power connections to the motor
IN_A, IN_B	Voltage controlled input pins with hysteresis, CMOS compatible. These two pins control the state of the bridge in normal operation according to the truth table (brake to V_{CC} , brake to GND, clockwise and counterclockwise).
PWM	Voltage controlled input pin with hysteresis, CMOS compatible. Gates of low side FETs are modulated by the PWM signal during their ON phase allowing speed control of the motor.
$EN_A/DIAG_A, EN_B/DIAG_B$	Open drain bidirectional logic pins. These pins must be connected to an external pull up resistor. When externally pulled low, they disable half-bridge A or B. In case of fault detection (thermal shutdown of a high side FET or excessive ON state voltage drop across a low side FET), these pins are pulled low by the device (see truth table in fault condition).
CS	Analog current sense output. This output sources a current proportional to the motor current. The information can be read back as an analog voltage across an external resistor.

2 Electrical specifications

Figure 3. Current and voltage conventions

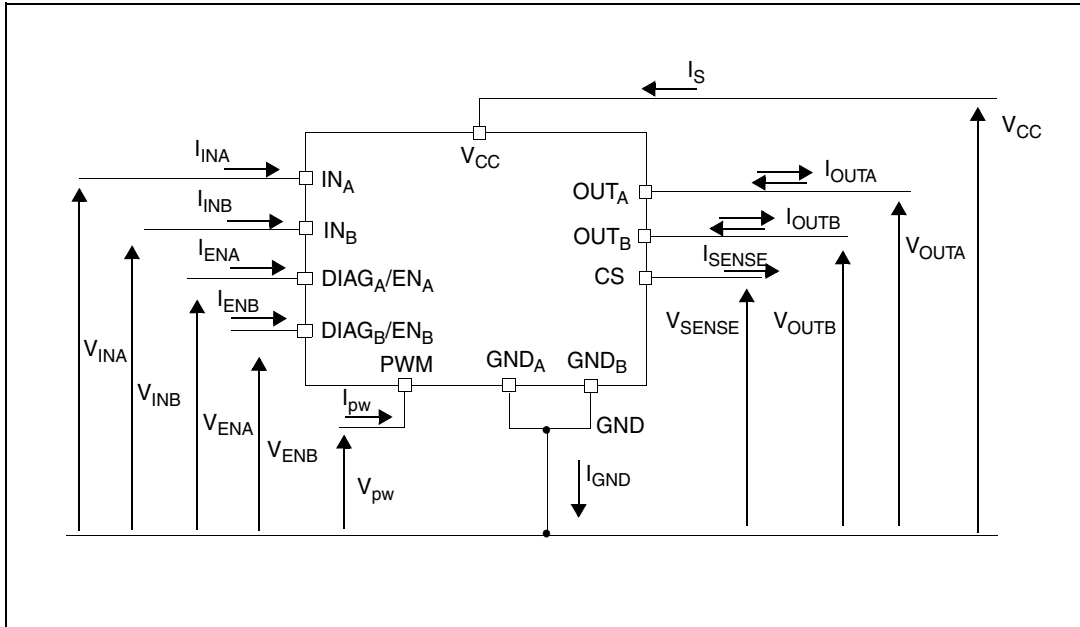

2.1 Absolute maximum ratings

Table 5. Absolute maximum ratings

Symbol	Parameter	Value	Unit
V_{CC}	Supply voltage	+41	V
I_{max}	Maximum output current (continuous)	30	A
I_R	Reverse output current (continuous)	-30	
I_{IN}	Input current (IN_A and IN_B pins)	± 10	mA
I_{EN}	Enable input current ($DIAG_A/EN_A$ and $DIAG_B/EN_B$ pins)	± 10	
I_{pw}	PWM input current	± 10	
V_{CS}	Current sense maximum voltage	-3/+15	V
V_{ESD}	Electrostatic discharge ($R = 1.5k\Omega$, $C = 100pF$)		
	– CS pin	2	kV
	– logic pins	4	kV
	– output pins: OUT_A , OUT_B , V_{CC}	5	kV
T_j	Junction operating temperature	Internally limited	$^{\circ}C$
T_c	Case operating temperature	-40 to 150	
T_{STG}	Storage temperature	-55 to 150	

2.2 Electrical characteristics

$V_{CC} = 9V$ up to 16 V; $-40^{\circ}C < T_J < 150^{\circ}C$, unless otherwise specified.

Table 6. Power section

Symbol	Parameter	Test conditions	Min	Typ	Max	Unit
V_{CC}	Operating supply voltage		5.5		16	V
I_S	Supply current	Off state with all Fault Cleared & $EN_x=0$ $I_{N_A} = I_{N_B} = PWM = 0$; $T_J = 25^{\circ}C$; $V_{CC} = 13V$ $I_{N_A} = I_{N_B} = PWM = 0$ Off state: $I_{N_A} = I_{N_B} = PWM = 0$		12	30 60	μA μA mA
		On state: I_{N_A} or $I_{N_B} = 5V$, no PWM			10	mA
R_{ONHS}	Static high side resistance	$I_{OUT} = 15A$; $T_J = 25^{\circ}C$			14	m Ω
		$I_{OUT} = 15A$; $T_J = -40$ to $150^{\circ}C$			28	
R_{ONLS}	Static low side resistance	$I_{OUT} = 15A$; $T_J = 25^{\circ}C$			5	
		$I_{OUT} = 15A$; $T_J = -40$ to $150^{\circ}C$			10	
V_f	High side free-wheeling diode forward voltage	$I_f = 15A$		0.8	1.1	V
$I_{L(off)}$	High side off state output current (per channel)	$T_J = 25^{\circ}C$; $V_{OUTX} = EN_x = 0V$; $V_{CC} = 13V$			3	μA
		$T_J = 125^{\circ}C$; $V_{OUTX} = EN_x = 0V$; $V_{CC} = 13V$			5	
I_{RM}	Dynamic cross-conduction current	$I_{OUT} = 15A$ (see Figure 7)		0.7		A

Table 7. Logic inputs (I_{N_A} , I_{N_B} , EN_A , EN_B)

Symbol	Parameter	Test conditions	Min	Typ	Max	Unit
V_{IL}	Input low level voltage	Normal operation ($DIAG_x/EN_x$ pin acts as an input pin)			1.25	V
V_{IH}	Input high level voltage		3.25			
V_{IHYST}	Input hysteresis voltage		0.5			
V_{ICL}	Input clamp voltage	$I_{IN} = 1mA$	5.5	6.3	7.5	
		$I_{IN} = -1mA$	-1.0	-0.7	-0.3	
I_{INL}	Input low current	$V_{IN} = 1.25V$	1			μA
I_{INH}	Input high current	$V_{IN} = 3.25V$			10	
V_{DIAG}	Enable output low level voltage	Fault operation ($DIAG_x/EN_x$ pin acts as an output pin); $I_{EN} = 1mA$			0.4	V

Table 8. PWM

Symbol	Parameter	Test conditions	Min	Typ	Max	Unit
V _{pwl}	PWM low level voltage				1.25	V
I _{pwl}	PWM pin current	V _{pw} = 1.25V	1			μA
V _{pwh}	PWM high level voltage		3.25			V
I _{pwh}	PWM pin current	V _{pw} = 3.25V			10	μA
V _{pwhhyst}	PWM hysteresis voltage		0.5			V
V _{pwcl}	PWM clamp voltage	I _{pw} = 1mA	V _{CC} + 0.3	V _{CC} + 0.7	V _{CC} + 1.0	
		I _{pw} = -1mA	-6.0	-4.5	-3.0	
C _{INPWM}	PWM pin input capacitance	V _{IN} = 2.5V			25	pF

Table 9. Switching (V_{CC} = 13V, R_{LOAD} = 0.87Ω , unless otherwise specified)

Symbol	Parameter	Test conditions	Min	Typ	Max	Unit
f	PWM frequency		0		20	kHz
t _{d(on)}	Turn-on delay time	Input rise time < 1μs (see Figure 6)			250	μs
t _{d(off)}	Turn-off delay time	Input rise time < 1μs (see Figure 6)			250	
t _r	Rise time	(see Figure 5)		1	1.6	
t _f	Fall time	(see Figure 5)		1.2	2.4	
t _{DEL}	Delay time during change of operating mode	(see Figure 4)	300	600	1800	
t _{rr}	High side free wheeling diode reverse recovery time	(see Figure 7)		110		ns
t _{off(min)} ⁽¹⁾	PWM minimum off time	9V < V _{CC} < 16V; T _j = 25°C; L = 250μH; I _{OUT} = 15A			6	μs

1. To avoid false Short to Battery detection during PWM operation, the PWM signal must be low for a time longer than 6μs.

Table 10. Protection and diagnostic

Symbol	Parameter	Test conditions	Min	Typ	Max	Unit
V _{USD}	Undervoltage shut-down				5.5	V
	Undervoltage reset			4.7		
V _{OV}	Overvoltage shut-down		16	19	22	
I _{LIM}	High side current limitation		30	50	70	A
V _{CLP}	Total clamp voltage (V _{CC} to GND)	I _{OUT} = 15A	43	48	54	V
T _{TSD}	Thermal shut-down temperature	V _{IN} = 3.25V	150	175	200	°C
T _{TR}	Thermal reset temperature		135			
T _{HYST}	Thermal hysteresis		7	15		

Table 11. Current sense ($9V < V_{CC} < 16V$)

Symbol	Parameter	Test conditions	Min	Typ	Max	Unit
K_1	I_{OUT}/I_{SENSE}	$I_{OUT} = 30A; R_{SENSE} = 1.5k\Omega;$ $T_j = -40 \text{ to } 150^\circ\text{C}$	9665	11370	13075	
K_2	I_{OUT}/I_{SENSE}	$I_{OUT} = 8A; R_{SENSE} = 1.5k\Omega;$ $T_j = -40 \text{ to } 150^\circ\text{C}$	9096	11370	13644	
$dK_1 / K_1^{(1)}$	Analog sense current drift	$I_{OUT} = 30A; R_{SENSE} = 1.5k\Omega;$ $T_j = -40 \text{ to } 150^\circ\text{C}$	-8		+8	%
$dK_2 / K_2^{(1)}$	Analog sense current drift	$I_{OUT} > 8A; R_{SENSE} = 1.5k\Omega;$ $T_j = -40 \text{ to } 150^\circ\text{C}$	-10		+10	
I_{SENSE0}	Analog sense leakage current	$I_{OUT} = 0A; V_{SENSE} = 0V;$ $T_j = -40 \text{ to } 150^\circ\text{C}$	0		65	μA

1. Analog sense current drift is deviation of factor K for a given device over (-40°C to 150°C and $9V < V_{CC} < 16V$) with respect to its value measured at $T_j = 25^\circ\text{C}, V_{CC} = 13V$.

Figure 4. Definition of the delay times measurement

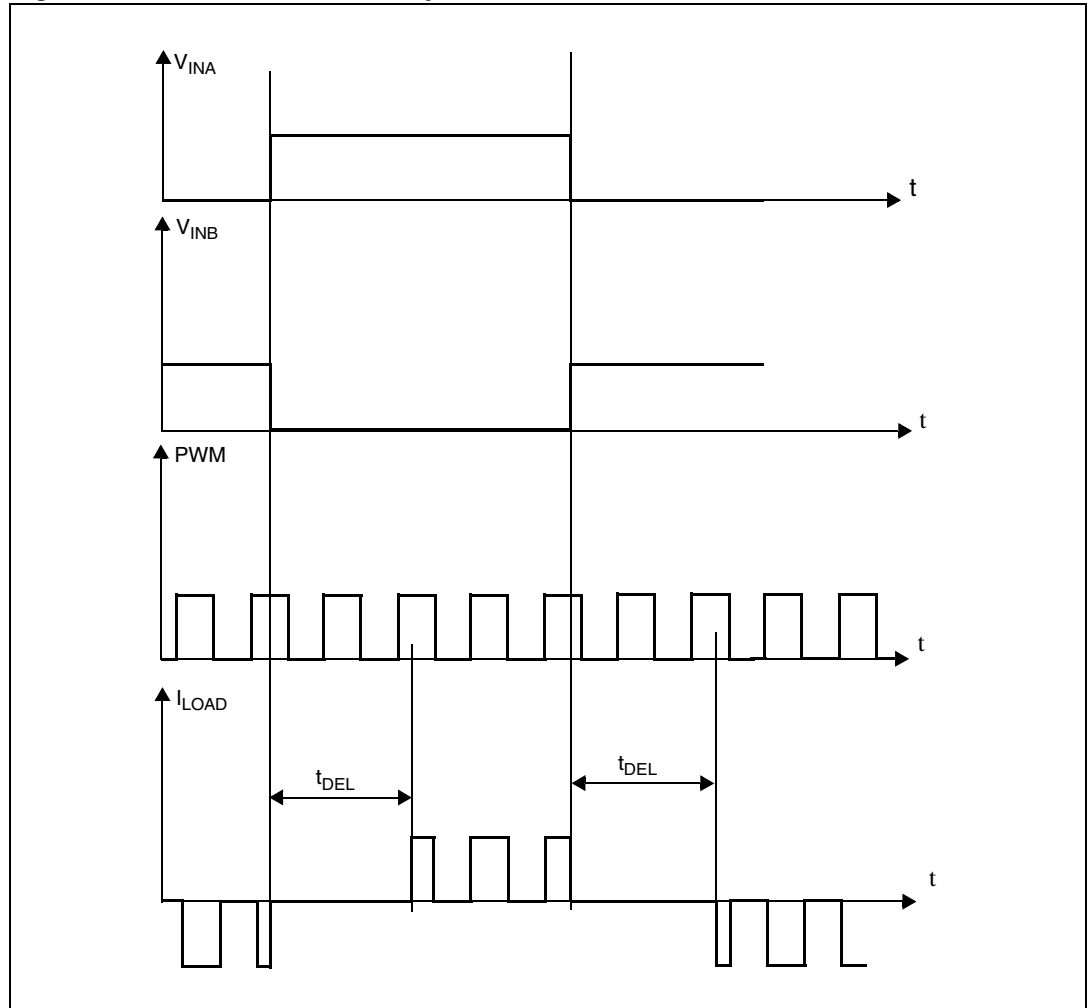

Figure 5. Definition of the low side switching times

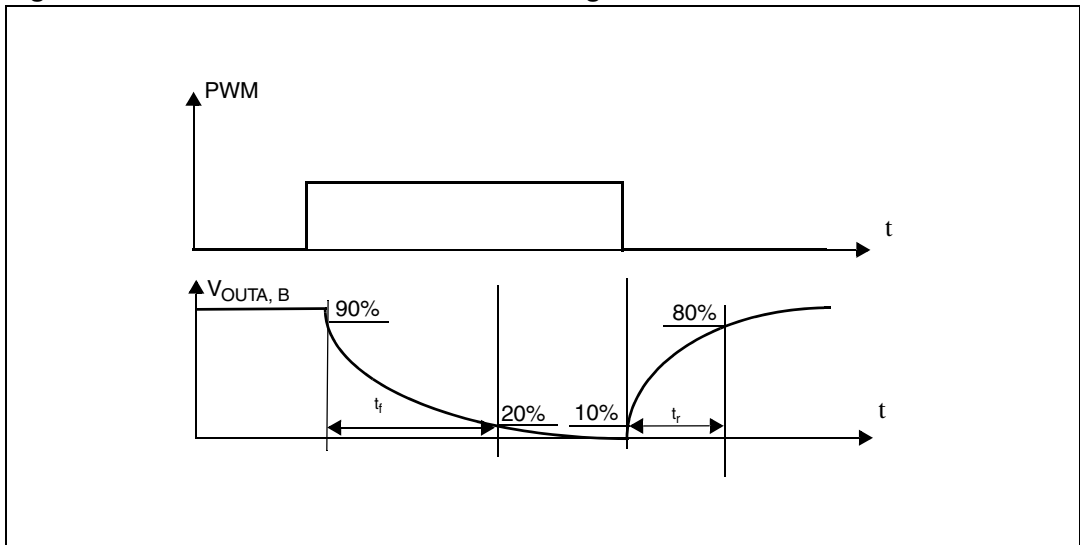

Figure 6. Definition of the high side switching times

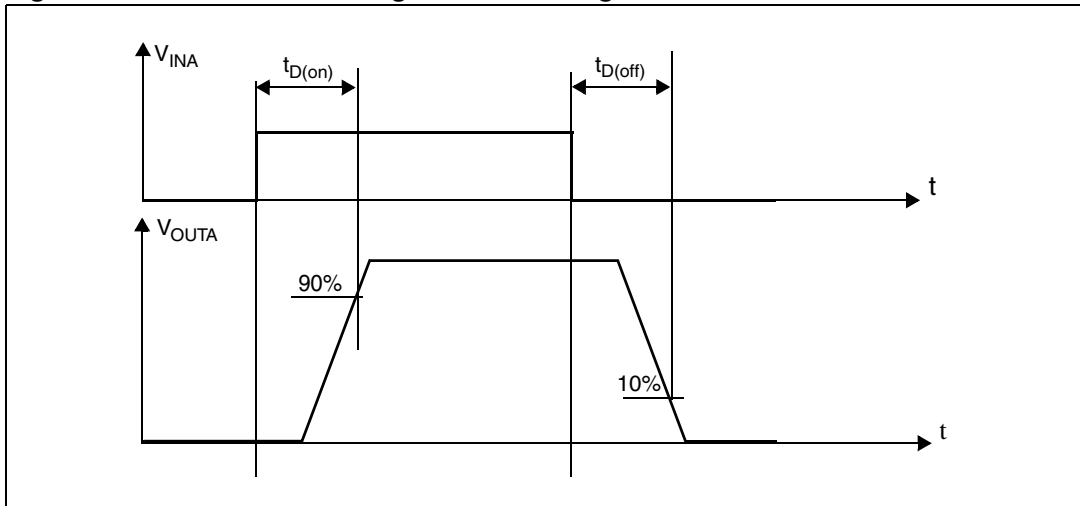

Figure 7. Definition of dynamic cross conduction current during a PWM operation

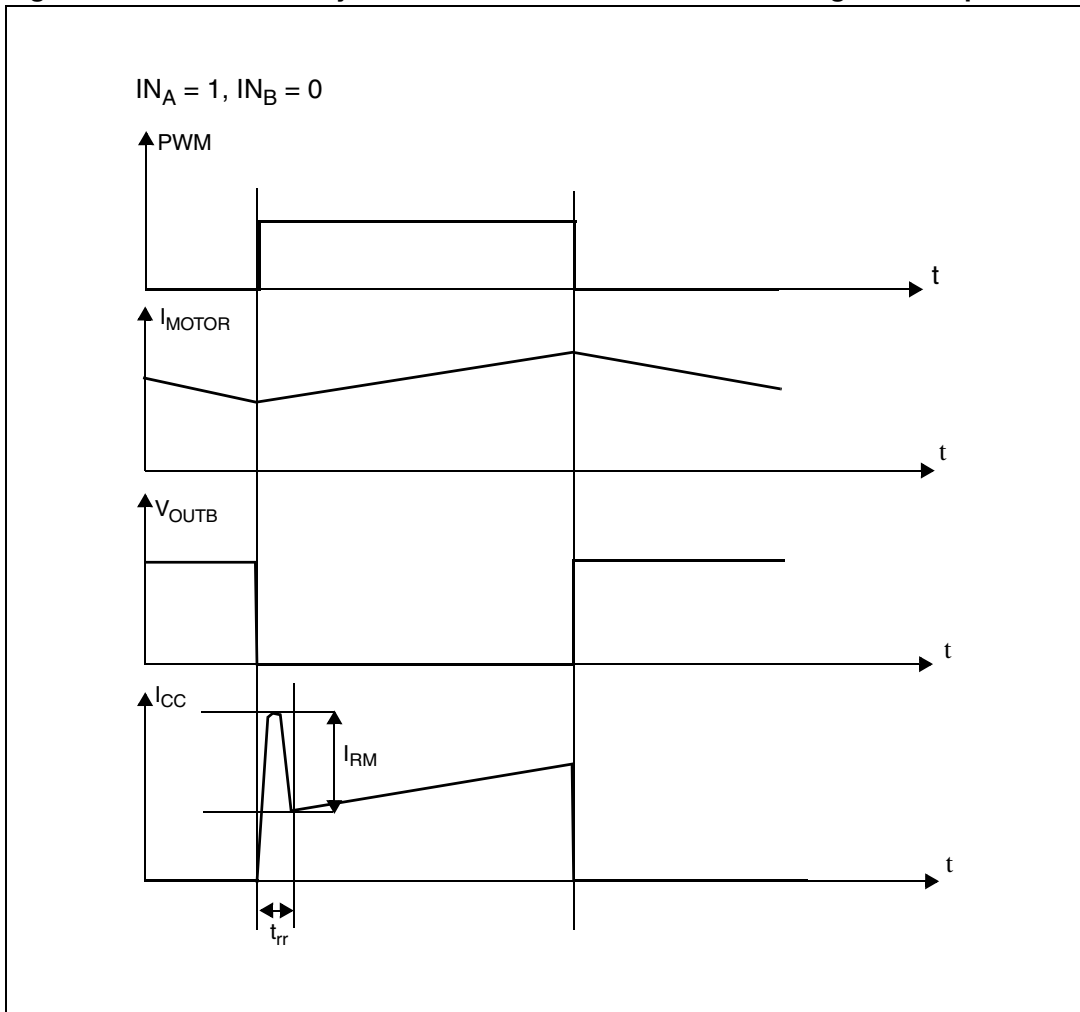

Table 12. Truth table in normal operating conditions

IN _A	IN _B	DIAG _A /EN _A	DIAG _B /EN _B	OUT _A	OUT _B	CS	Operating mode
1	1	1	1	H	H	High Imp.	Brake to V _{CC}
	L				I _{SENSE} = I _{OUT} /K	Clockwise (CW)	
0	1			L		H	Counterclockwise (CCW)
	0			L	L	High Imp.	Brake to GND

Table 13. Truth table in fault conditions (detected on OUT_A)

IN _A	IN _B	DIAG _A /EN _A	DIAG _B /EN _B	OUT _A	OUT _B	CS
1	1	0	1	OPEN	H	High Imp.
	0				L	
0	1				H	I _{OUTB} /K
	0					L
X	X				0	OPEN
	1				1	H
	0	L	High Imp.			

↑
Fault Information
↑
Protection Action

Note: Notice that saturation detection on the low side power MOSFET is possible only if the impedance of the short-circuit from the output to the battery is less than 100mΩ when the device is supplied with a battery voltage of 13.5V.

Table 14. Electrical transient requirements

ISO T/R - 7637/1 Test pulse	Test Level I	Test Level II	Test Level III	Test Level IV	Test levels delays and impedance
1	-25V	-50V	-75V	-100V	2ms, 10Ω
2	+25V	+50V	+75V	+100V	0.2ms, 10Ω
3a	-25V	-50V	-100V	-150V	0.1μs, 50Ω
3b	+25V	+50V	+75V	+100V	
4	-4V	-5V	-6V	-7V	100ms, 0.01Ω
5	+26.5V	+46.5V	+66.5V	+86.5V	400ms, 2Ω

ISO T/R - 7637/1 test pulse	Test levels result I	Test levels result II	Test levels result III	Test levels result IV
1	C	C	C	C
2				
3a				
3b				
4				
5 ⁽¹⁾		E	E	E

1. For load dump exceeding the above value a centralized suppressor must be adopted.

Class	Contents
C	All functions of the device are performed as designed after exposure to disturbance.
E	One or more functions of the device are not performed as designed after exposure to disturbance and cannot be returned to proper operation without replacing the device.

2.3 Electrical characteristics curves

Figure 8. On state supply current

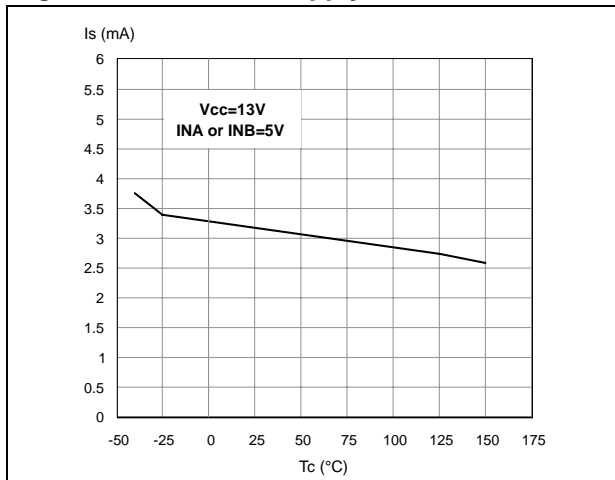

Figure 9. Off state supply current

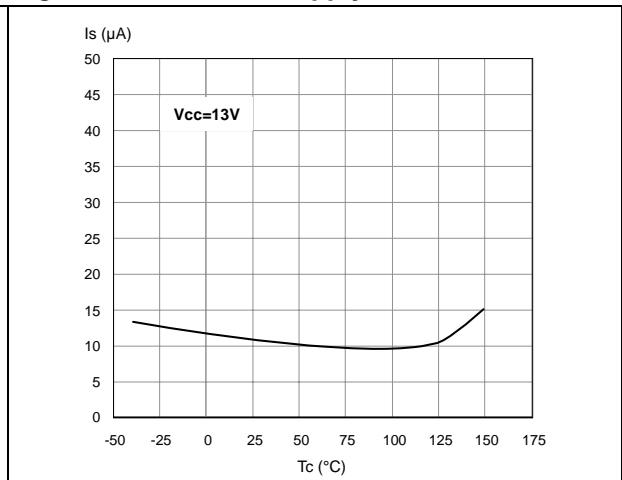

Figure 10. High level input current

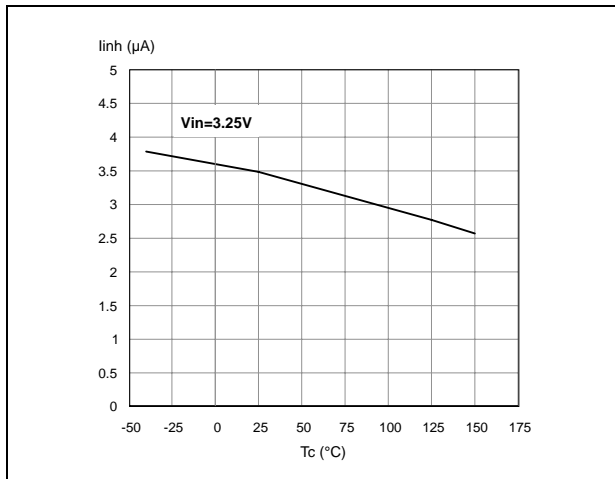

Figure 11. Input clamp voltage

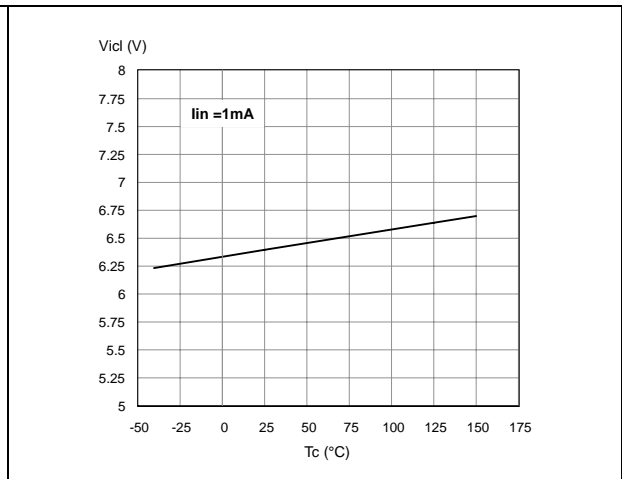

Figure 12. Input high level voltage

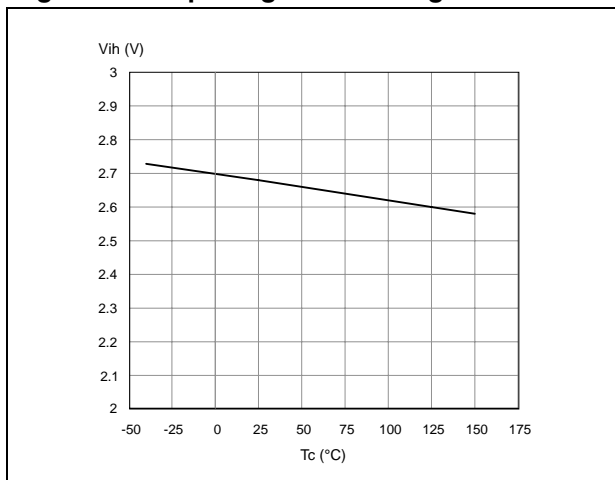

Figure 13. Input low level voltage

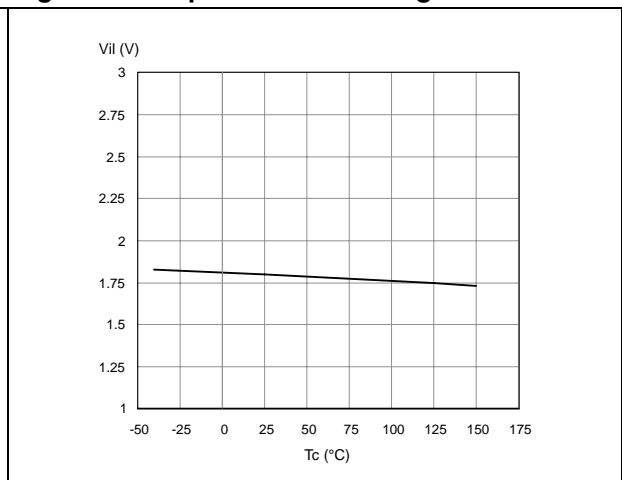

Figure 14. Input hysteresis voltage

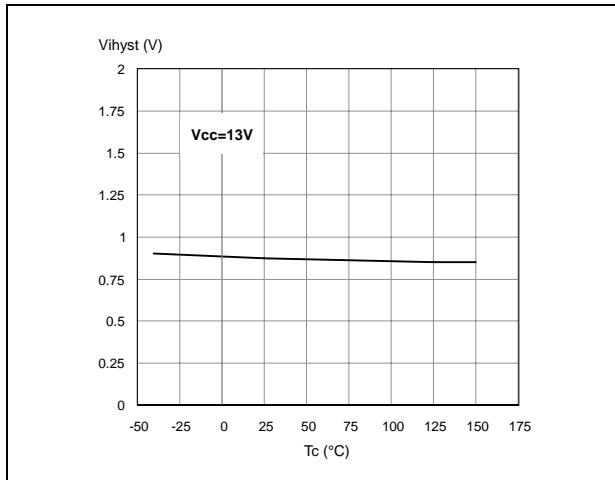

Figure 15. High level enable pin current

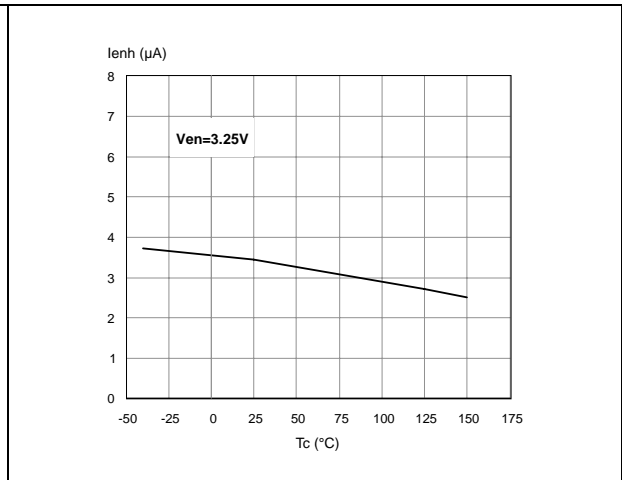

Figure 16. Delay time during change of operation mode

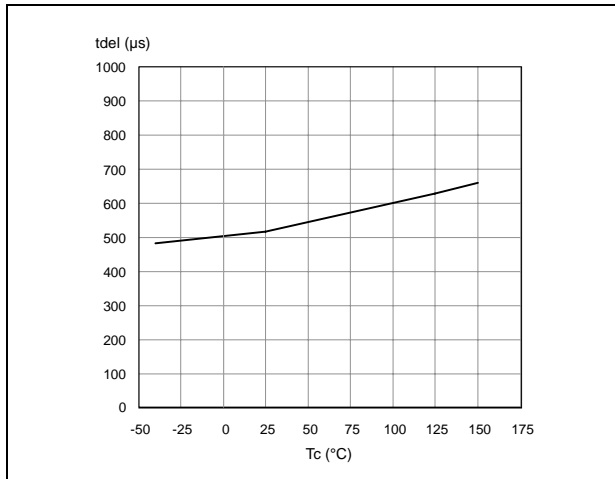

Figure 17. Enable clamp voltage

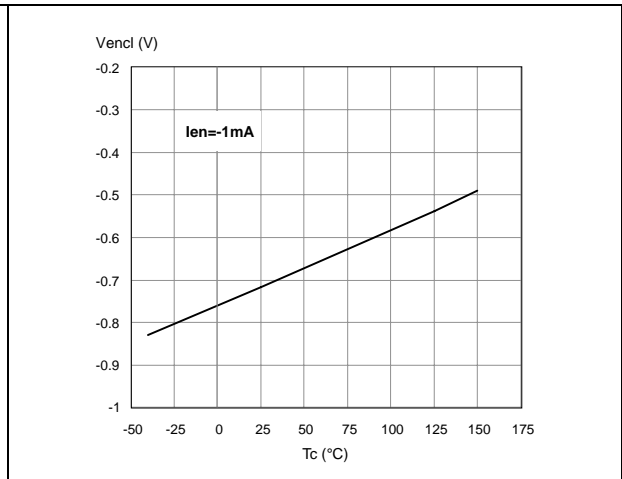

Figure 18. High level enable voltage

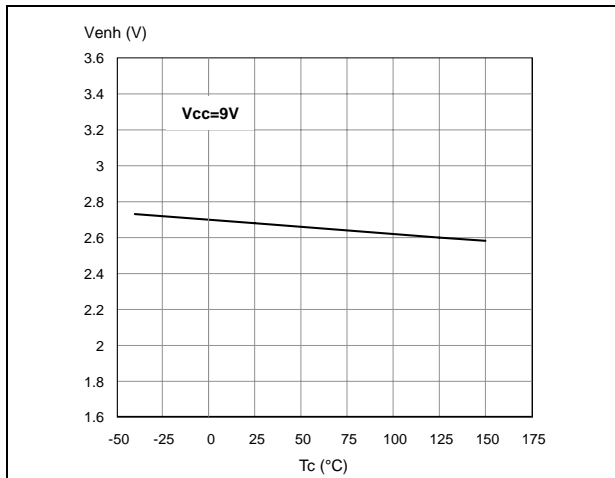

Figure 19. Low level enable voltage

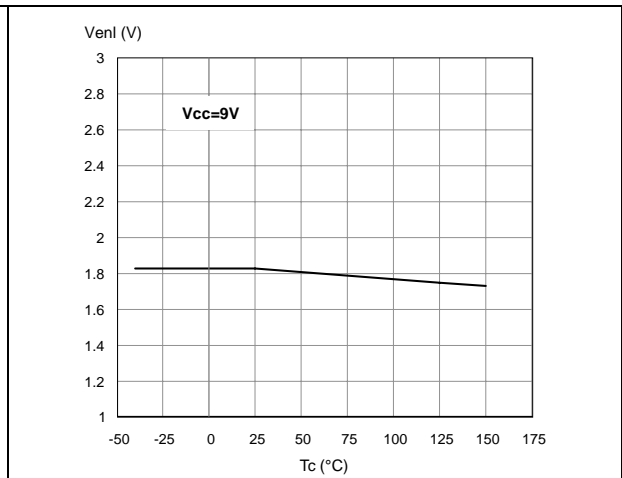

Figure 20. PWM high level voltage

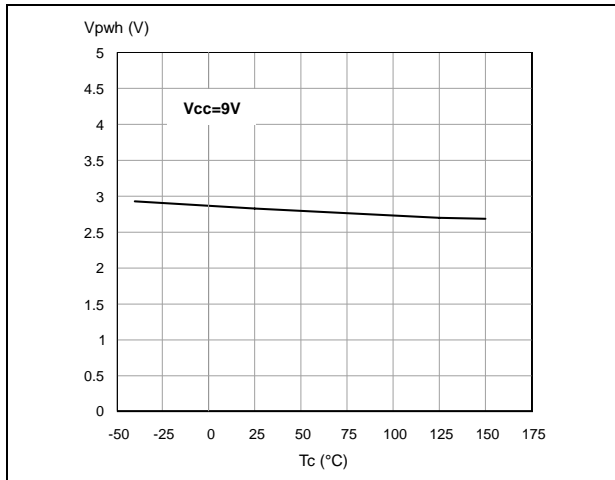

Figure 21. PWM low level voltage

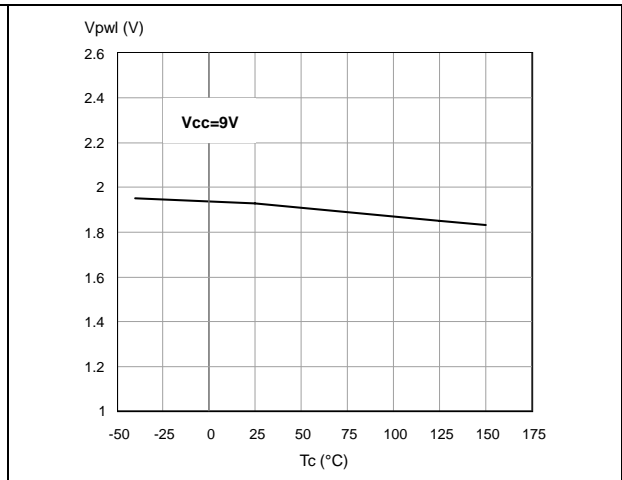

Figure 22. PWM high level current

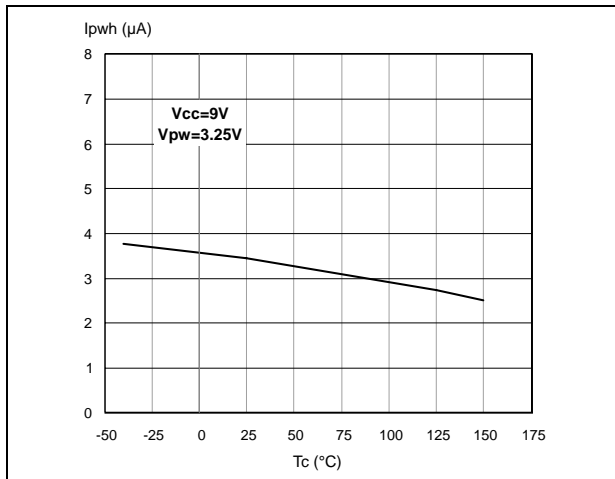

Figure 23. Overvoltage shutdown

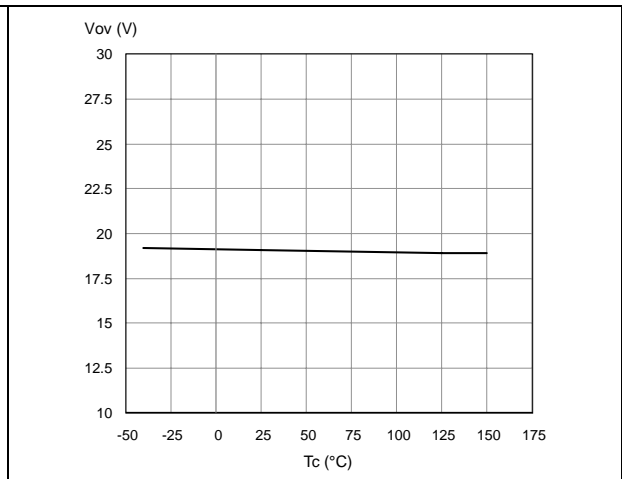

Figure 24. Undervoltage shutdown

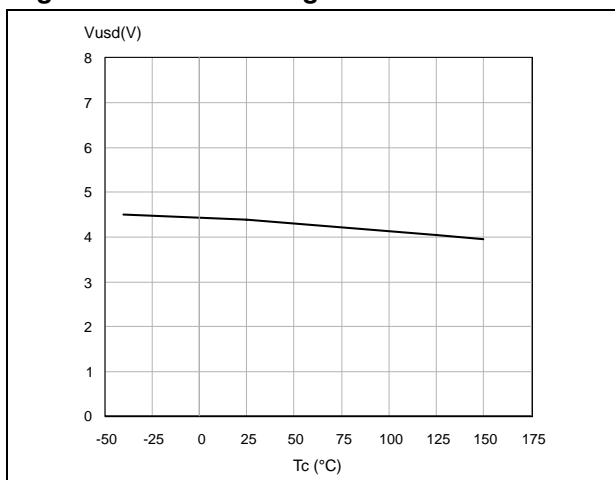

Figure 25. Current limitation

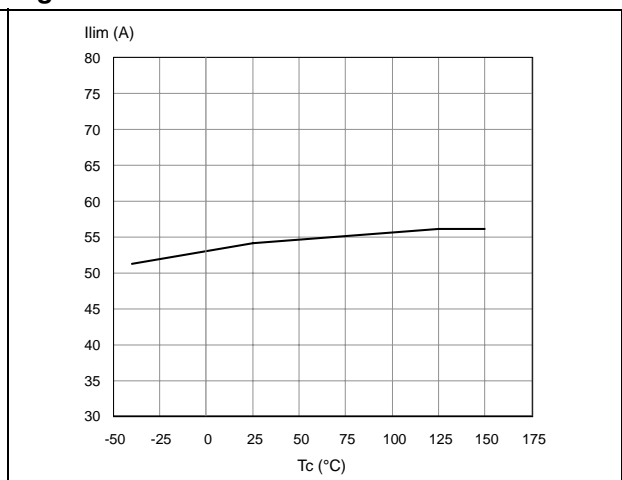

Figure 26. On state high side resistance vs T_{case}

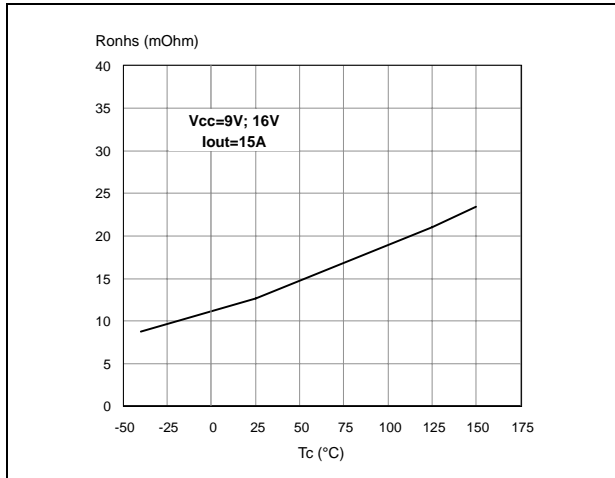

Figure 27. On state low side resistance vs T_{case}

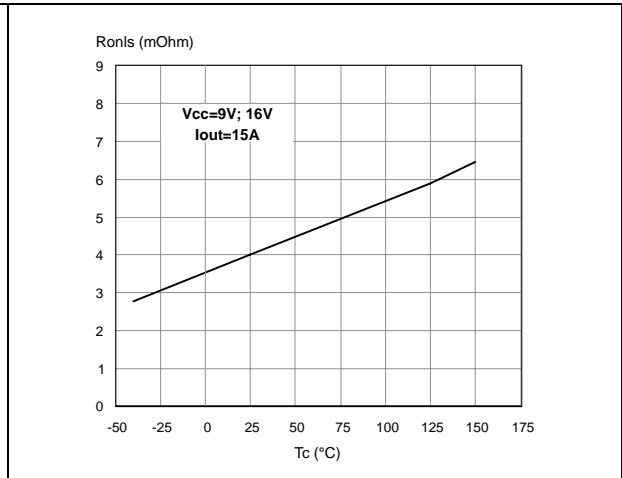

Figure 28. Turn-On delay time

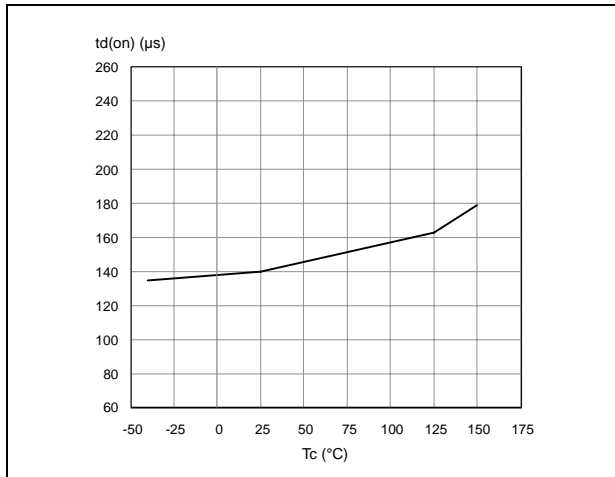

Figure 29. Turn-Off delay time

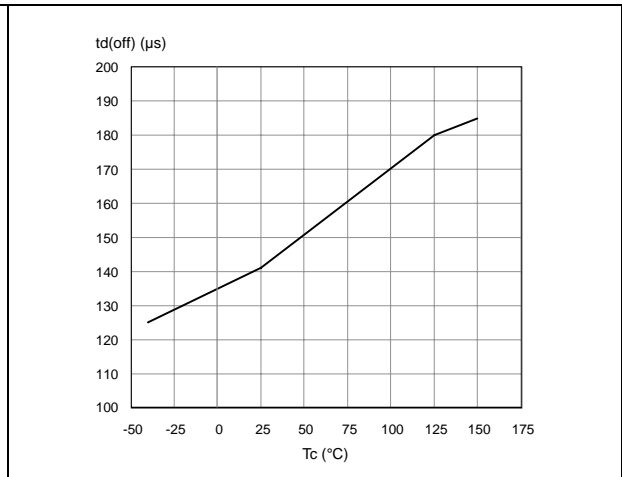

Figure 30. Output voltage rise time

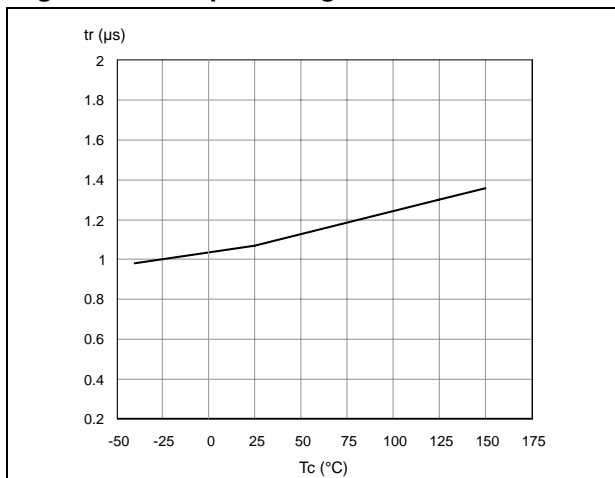
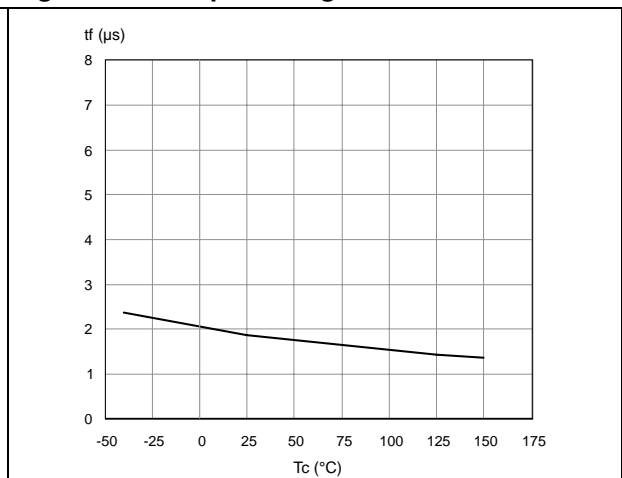

Figure 31. Output voltage fall time



3 Application information

In normal operating conditions the DIAG_X/EN_X pin is considered as an input pin by the device. This pin must be externally pulled high.

PWM pin usage: in all cases, a “0” on the PWM pin will turn off both LS_A and LS_B switches. When PWM rises back to “1”, LS_A or LS_B turn on again depending on the input pin state.

Figure 32. Typical application circuit for DC to 20 kHz PWM operation short circuit protection

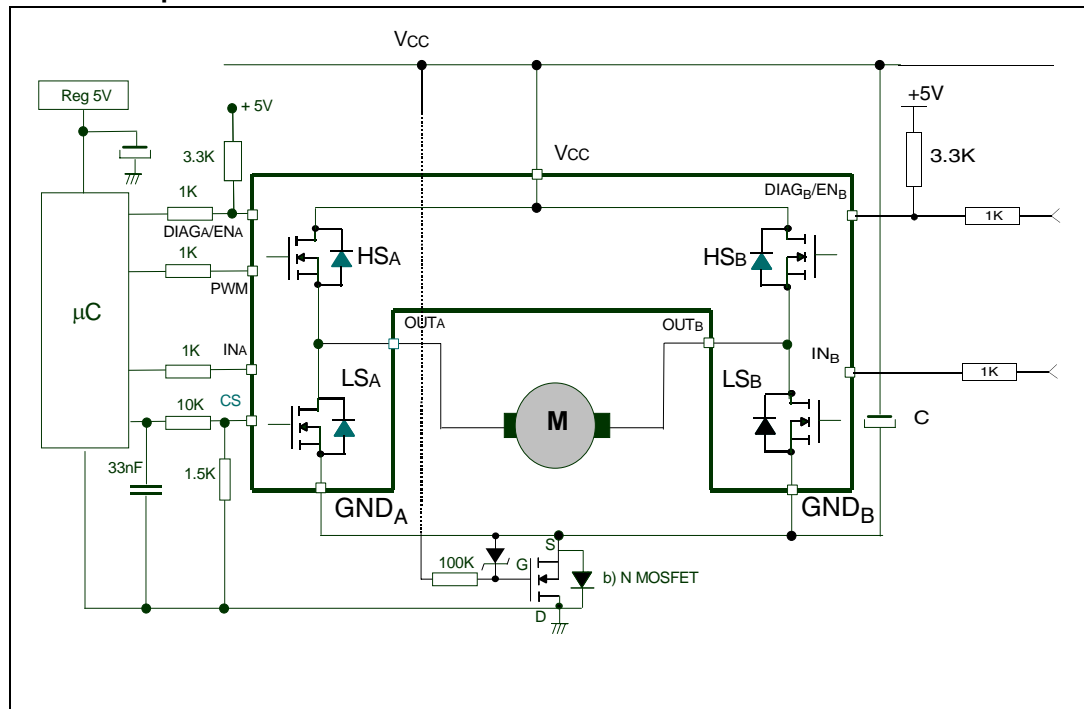

Note: The value of the blocking capacitor (C) depends on the application conditions and defines voltage and current ripple onto supply line at PWM operation. Stored energy of the motor inductance may fly back into the blocking capacitor, if the bridge driver goes into tri-state. This causes a hazardous overvoltage if the capacitor is not big enough. As basic orientation, 500µF per 10A load current is recommended.

In case of a fault condition the DIAG_X/EN_X pin is considered as an output pin by the device. The fault conditions are:

- overtemperature on one or both high sides
- short to battery condition on the output (saturation detection on the low side power MOSFET)

Possible origins of fault conditions may be:

- OUT_A is shorted to ground → overtemperature detection on high side A.
- OUT_A is shorted to V_{CC} → low side power MOSFET saturation detection.

When a fault condition is detected, the user can know which power element is in fault by monitoring the IN_A , IN_B , $DIAG_A/EN_A$ and $DIAG_B/EN_B$ pins.

In any case, when a fault is detected, the faulty leg of the bridge is latched off. To turn on the respective output (OUT_X) again, the input signal must rise from low to high level.

Figure 33. Behavior in fault condition (How a fault can be cleared)

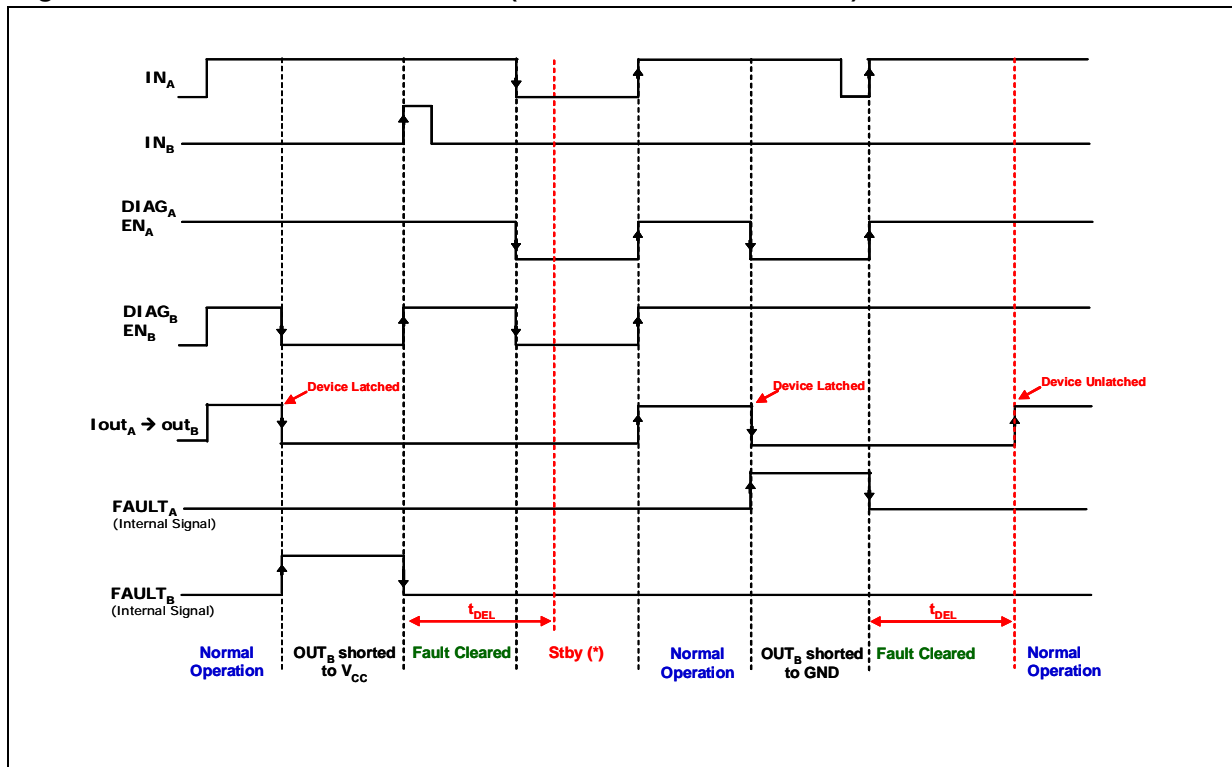

Note: In case of the fault condition is not removed, the procedure for unlatching and sending the device in Stby mode is:

- Clear the fault in the device (toggle : IN_A if $EN_A=0$ or IN_B if $EN_B=0$)
- Pull low all inputs, PWM and Diag/EN pins within t_{DEL} .

If the Diag/En pins are already low, PWM=0, the fault can be cleared simply toggling the input. The device will enter in stby mode as soon as the fault is cleared.

3.1 Reverse battery protection

Three possible solutions can be considered:

1. a Schottky diode D connected to V_{CC} pin
2. an N-channel MOSFET connected to the GND pin (see [Figure 32: Typical application circuit for DC to 20 kHz PWM operation short circuit protection on page 20](#))
3. a P-channel MOSFET connected to the V_{CC} pin

The device sustains no more than -30A in reverse battery conditions because of the two body diodes of the power MOSFETs. Additionally, in reverse battery condition the I/Os of VNH2SP30-E are pulled down to the V_{CC} line (approximately -1.5V). A series resistor must

be inserted to limit the current sunk from the microcontroller I/Os. If I_{Rmax} is the maximum target reverse current through μC I/Os, the series resistor is:

Figure 34. Half-bridge configuration

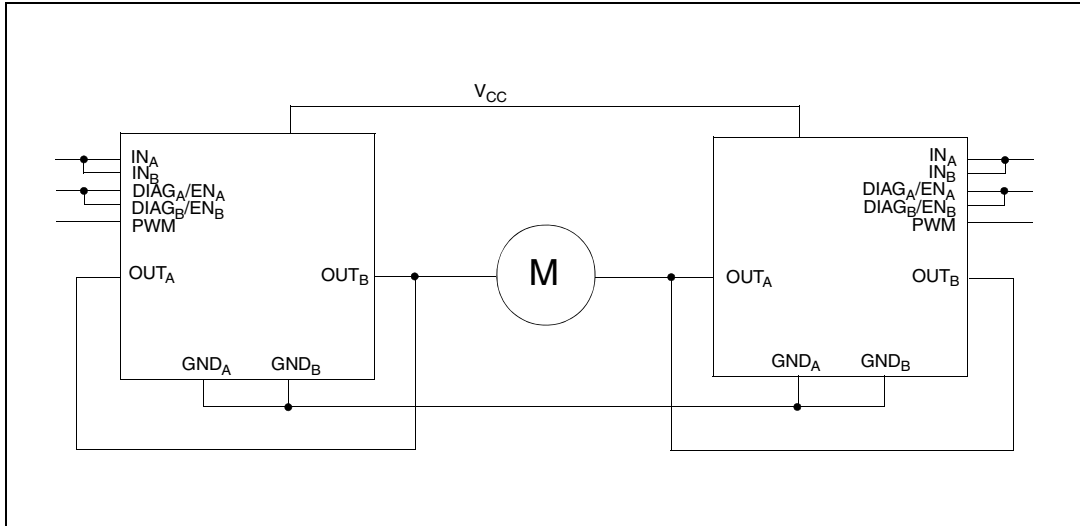

Note: The VNH2SP30-E can be used as a high power half-bridge driver achieving an On resistance per leg of 9.5mΩ.

Figure 35. Multi-motors configuration

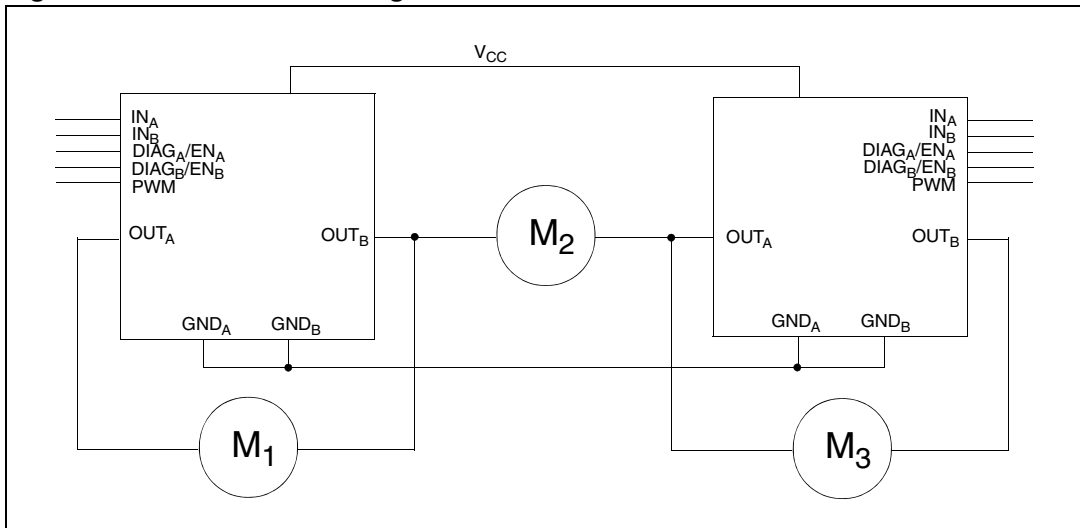

Note: The VNH2SP30-E can easily be designed in multi-motors driving applications such as seat positioning systems where only one motor must be driven at a time. $DIAG_X/EN_X$ pins allow to put unused half-bridges in high impedance.

Figure 36. Waveforms in full bridge operation

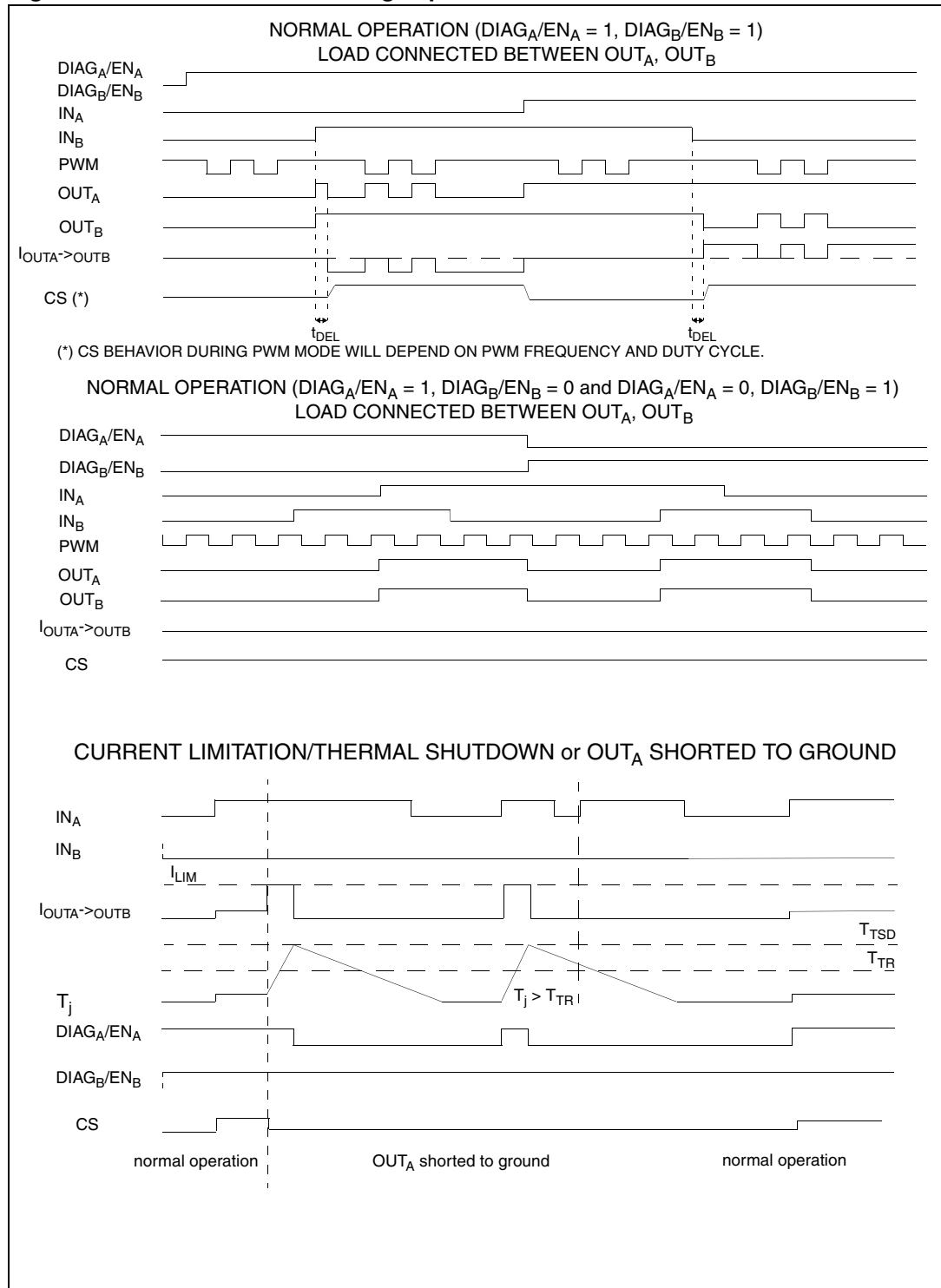
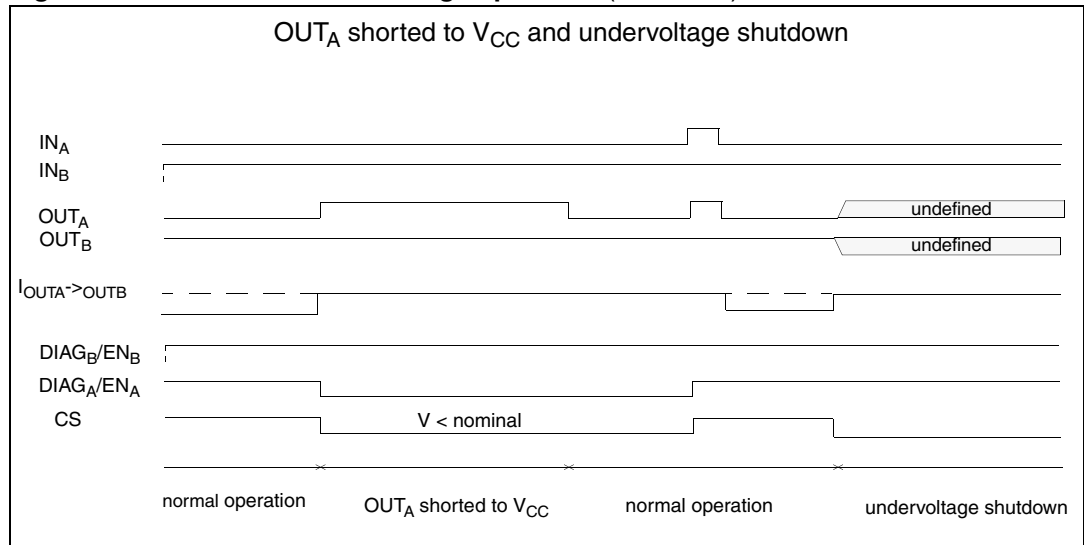

Figure 37. Waveforms in full bridge operation (continued)



4 Package and PCB thermal data

4.1 PowerSSO-30 thermal data

Figure 38. MultiPowerSO-30™ PC board

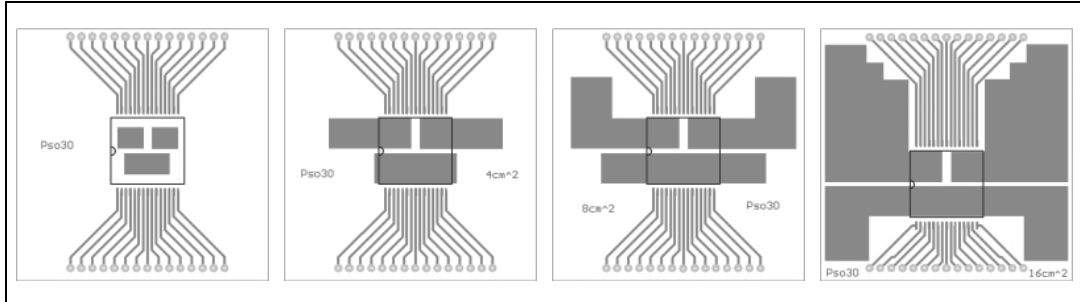

Note: Layout condition of R_{th} and Z_{th} measurements (PCB FR4 area = 58mm x 58mm, PCB thickness = 2mm. Cu thickness = 35 μ m, Copper areas: from minimum pad layout to 16cm²).

Figure 39. Chipset configuration

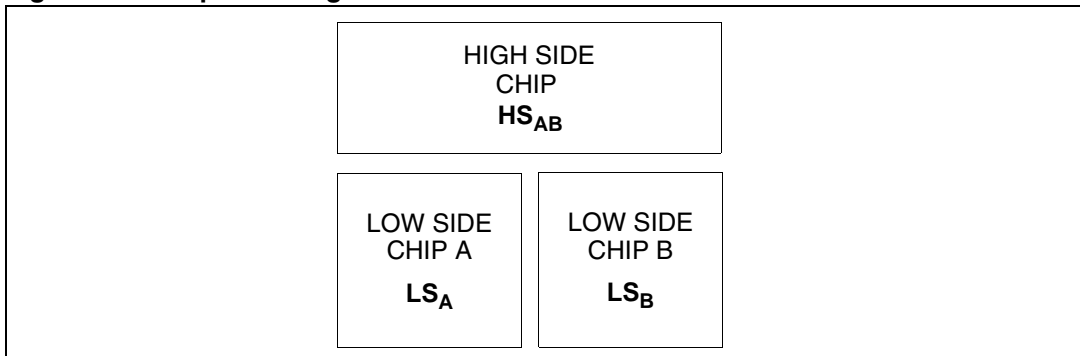
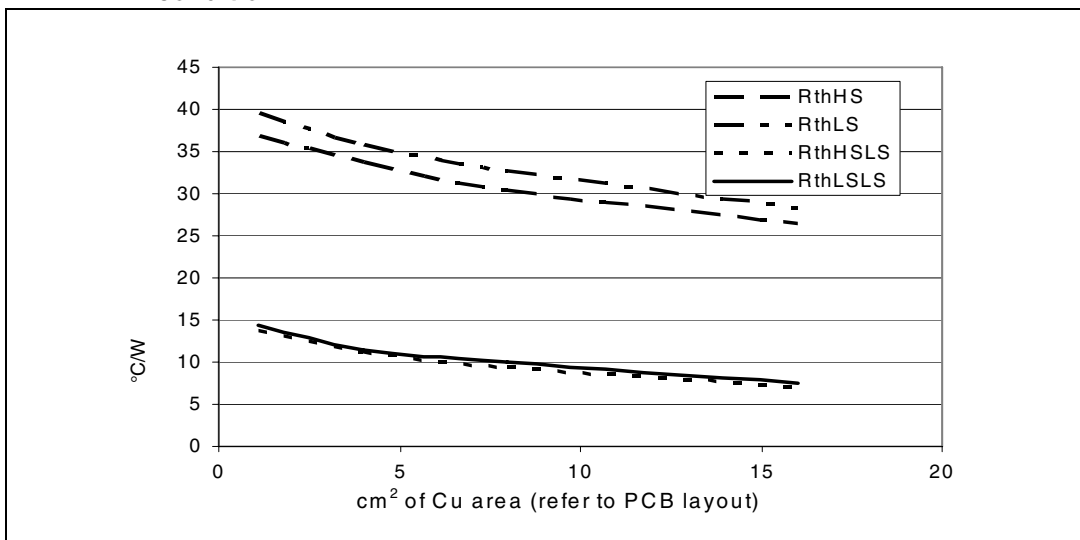

Figure 40. Auto and mutual $R_{thj-amb}$ vs PCB copper area in open box free air condition



4.1.1 Thermal calculation in clockwise and anti-clockwise operation in steady-state mode

Table 15. Thermal calculation in clockwise and anti-clockwise operation in steady-state mode

HS _A	HS _B	LS _A	LS _B	T _{jHSAB}	T _{jLSA}	T _{jLSB}
ON	OFF	OFF	ON	$P_{dHSA} \times R_{thHS} + P_{dLSB} \times R_{thHSLs} + T_{amb}$	$P_{dHSA} \times R_{thHSLs} + P_{dLSB} \times R_{thLSLs} + T_{amb}$	$P_{dHSA} \times R_{thHSLs} + P_{dLSB} \times R_{thLS} + T_{amb}$
OFF	ON	ON	OFF	$P_{dHSB} \times R_{thHS} + P_{dLSA} \times R_{thHSLs} + T_{amb}$	$P_{dHSB} \times R_{thHSLs} + P_{dLSA} \times R_{thLS} + T_{amb}$	$P_{dHSB} \times R_{thHSLs} + P_{dLSA} \times R_{thLSLs} + T_{amb}$

4.1.2 Thermal resistances definition (values according to the PCB heatsink area)

R_{thHS} = R_{thHSA} = R_{thHSB} = High Side Chip Thermal Resistance Junction to Ambient (HS_A or HS_B in ON state)

R_{thLS} = R_{thLSA} = R_{thLSB} = Low Side Chip Thermal Resistance Junction to Ambient

R_{thHSLs} = R_{thHSALSB} = R_{thHSBLSA} = Mutual Thermal Resistance Junction to Ambient between High Side and Low Side Chips

R_{thLSLs} = R_{thLSALSB} = Mutual Thermal Resistance Junction to Ambient between Low Side Chips

4.1.3 Thermal calculation in transient mode^(a)

$$T_{jHSAB} = Z_{thHS} \times P_{dHSAB} + Z_{thHSLs} \times (P_{dLSA} + P_{dLSB}) + T_{amb}$$

$$T_{jLSA} = Z_{thHSLs} \times P_{dHSAB} + Z_{thLS} \times P_{dLSA} + Z_{thLSLs} \times P_{dLSB} + T_{amb}$$

$$T_{jLSB} = Z_{thHSLs} \times P_{dHSAB} + Z_{thLSLs} \times P_{dLSA} + Z_{thLS} \times P_{dLSB} + T_{amb}$$

4.1.4 Single pulse thermal impedance definition (values according to the PCB heatsink area)

Z_{thHS} = High Side Chip Thermal Impedance Junction to Ambient

Z_{thLS} = Z_{thLSA} = Z_{thLSB} = Low Side Chip Thermal Impedance Junction to Ambient

Z_{thHSLs} = Z_{thHSABLSA} = Z_{thHSBLSB} = Mutual Thermal Impedance Junction to Ambient between High Side and Low Side Chips

Z_{thLSLs} = Z_{thLSALSB} = Mutual Thermal Impedance Junction to Ambient between Low Side Chips

a. Calculation is valid in any dynamic operating condition. P_d values set by user.

Equation 1: pulse calculation formula

$$Z_{TH\delta} = R_{TH} P \delta + Z_{THtp}(1 - \delta)$$

where $\delta = t_p/T$

Figure 41. MultiPowerSO-30 HSD thermal impedance junction ambient single pulse

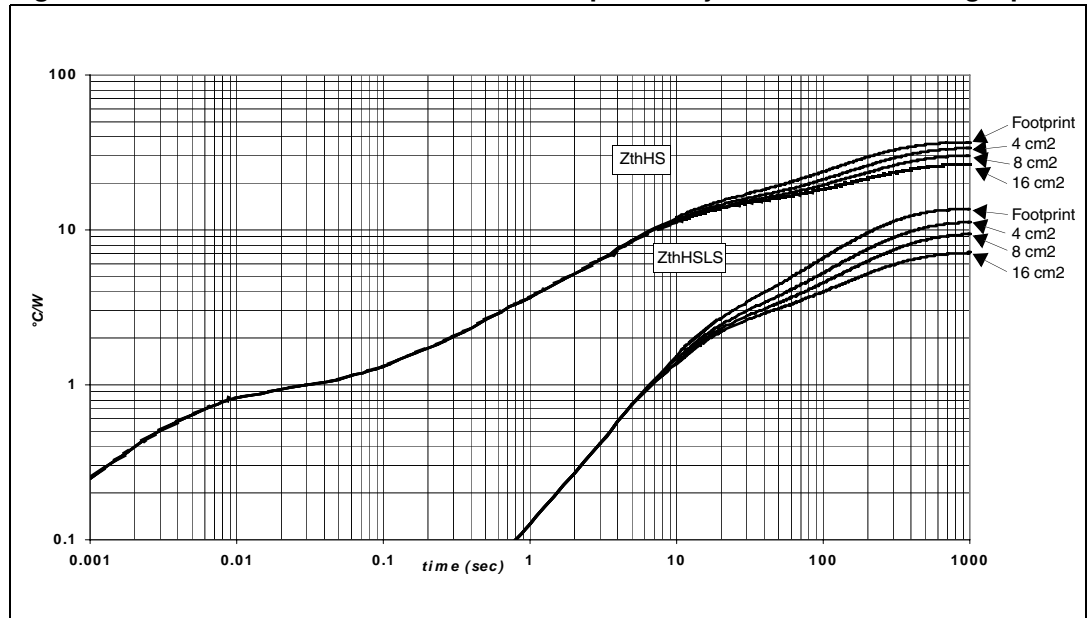

Figure 42. MultiPowerSO-30 LSD thermal impedance junction ambient single pulse

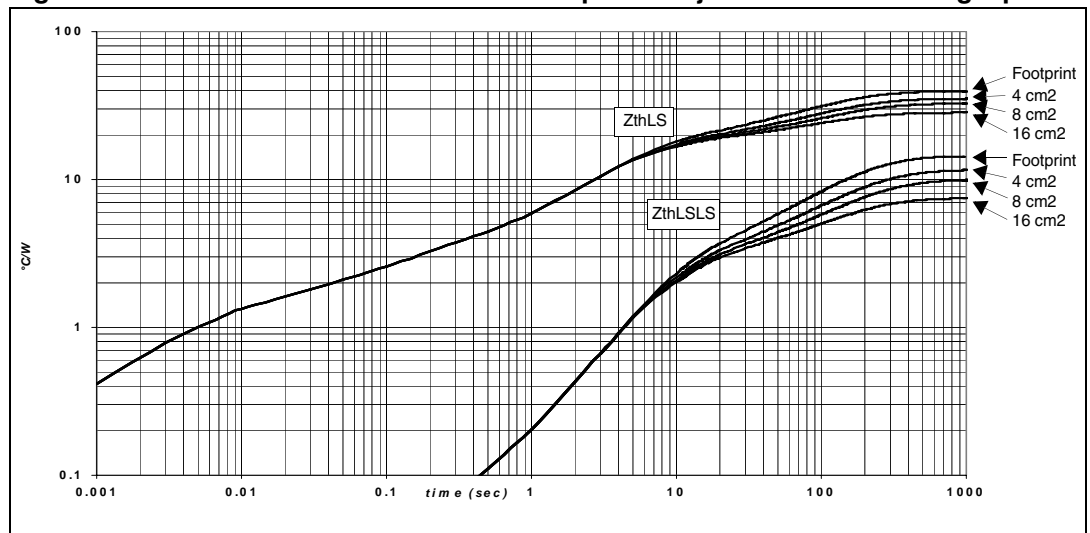

Figure 43. Thermal fitting model of an H-bridge in MultiPowerSO-30

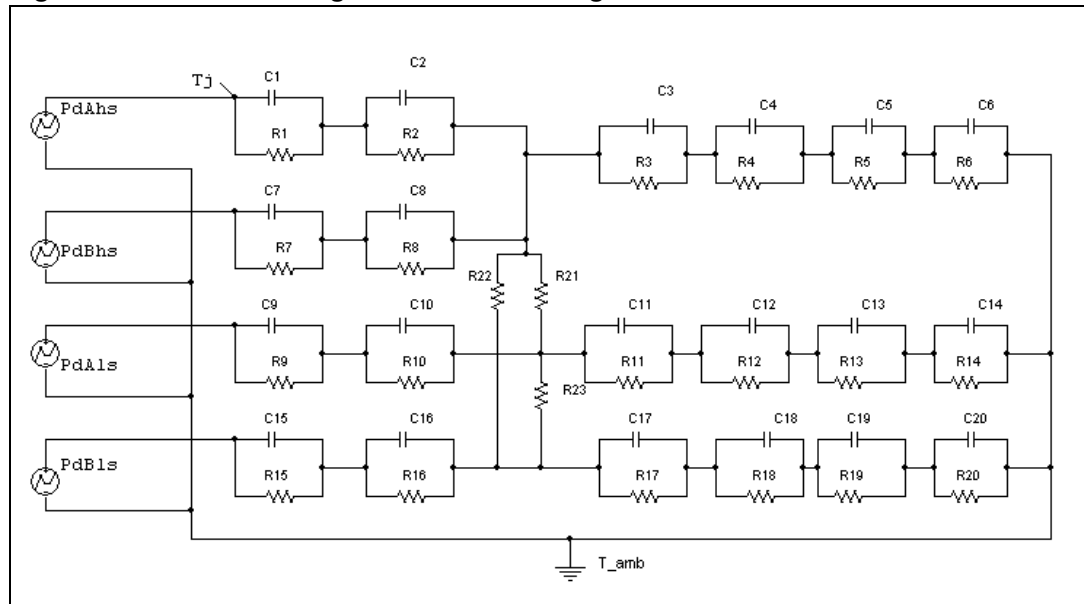

Table 16. Thermal parameters⁽¹⁾

Area/island (cm ²)	Footprint	4	8	16
R1 = R7 (°C/W)	0.05			
R2 = R8 (°C/W)	0.3			
R3 (°C/W)	0.5			
R4 (°C/W)	1.3			
R5 (°C/W)	14			
R6 (°C/W)	44.7	39.1	31.6	23.7
R9 = R15 (°C/W)	0.2			
R10 = R16 (°C/W)	0.4			
R11 = R17 (°C/W)	0.8			
R12 = R18 (°C/W)	1.5			
R13 = R19 (°C/W)	20			
R14 = R20 (°C/W)	46.9	36.1	30.4	20.8
R21 = R22 = R23 (°C/W)	115			
C1 = C7 (W.s/°C)	0.005			
C2 = C8 (W.s/°C)	0.008			
C3 = C11 = C17 (W.s/°C)	0.01			
C4 = C13 = C19 (W.s/°C)	0.3			
C5 (W.s/°C)	0.6			
C6 (W.s/°C)	5	7	9	11
C9 = C15 (W.s/°C)	0.003			
C10 = C16 (W.s/°C)	0.006			
C12 = C18 (W.s/°C)	0.075			
C14 = C20 (W.s/°C)	2.5	3.5	4.5	5.5

1. The blank space means that the value is the same as the previous one.

5 Package and packing information

5.1 ECOPACK® packages

In order to meet environmental requirements, ST offers these devices in ECOPACK® packages. ECOPACK® packages are lead-free. The category of Second Level Interconnect is marked on the package and on the inner box label, in compliance with JEDEC Standard JESD97. The maximum ratings related to soldering conditions are also marked on the inner box label.

ECOPACK is an ST trademark. ECOPACK specifications are available at www.st.com.

5.2 MultiPowerSO-30 package mechanical data

Figure 44. MultiPowerSO-30 package outline

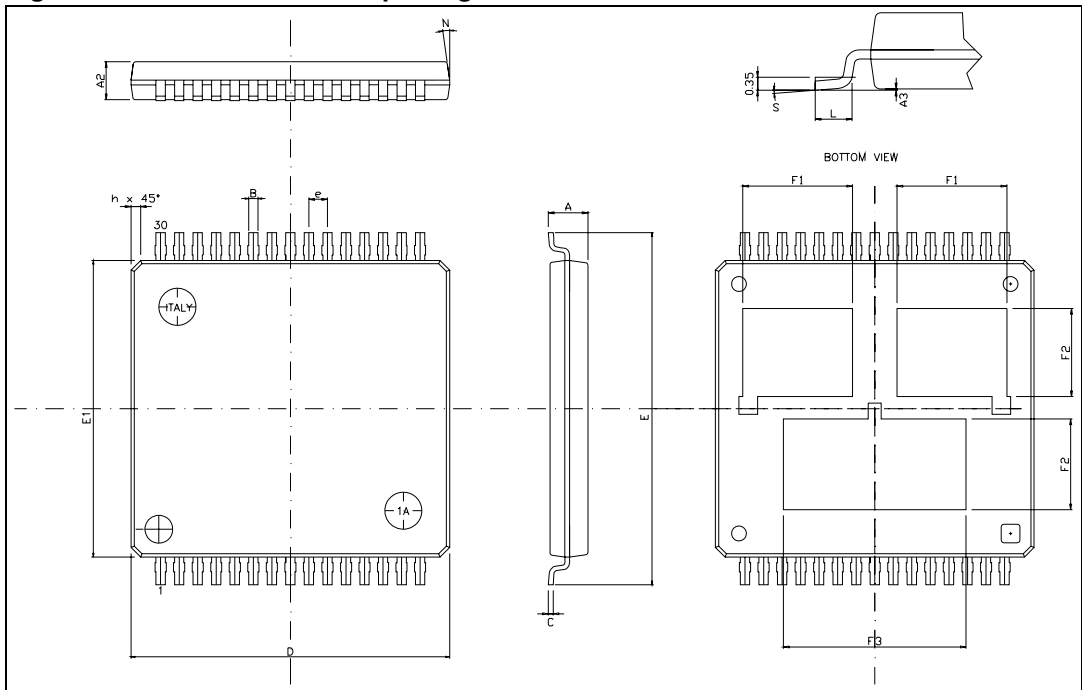
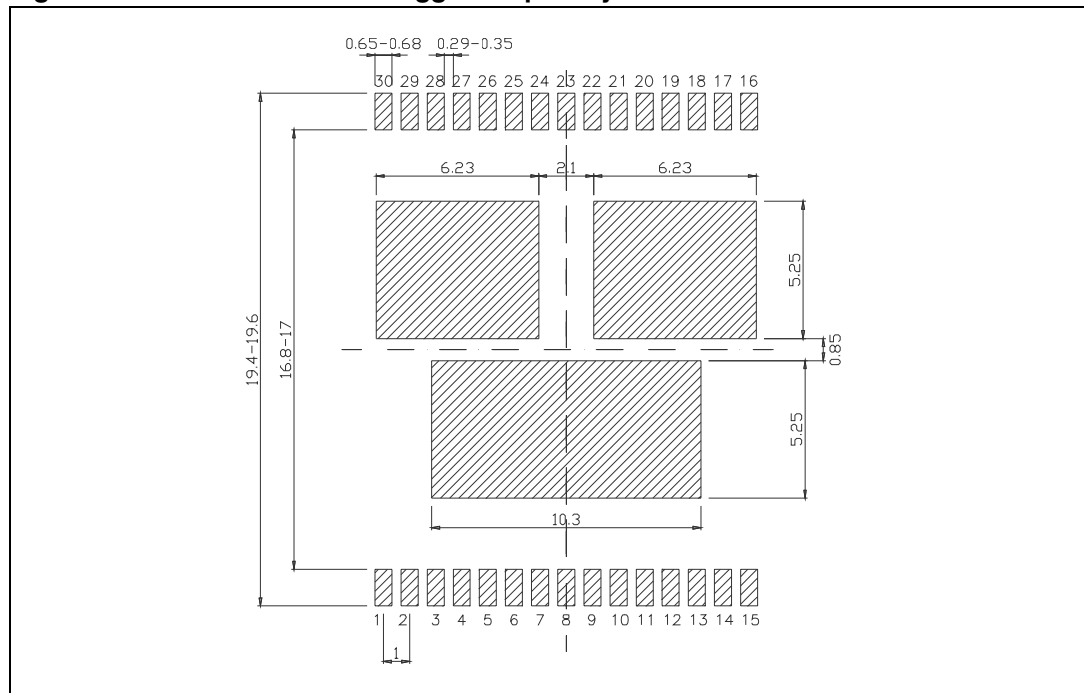

Table 17. MultiPowerSO-30 mechanical data

Symbol	Millimeters		
	Min	Typ	Max
A			2.35
A2	1.85		2.25
A3	0		0.1
B	0.42		0.58
C	0.23		0.32
D	17.1	17.2	17.3
E	18.85		19.15
E1	15.9	16	16.1
e		1	
F1	5.55		6.05
F2	4.6		5.1
F3	9.6		10.1
L	0.8		1.15
N			10deg
S	0deg		7deg

Figure 45. MultiPowerSO-30 suggested pad layout



5.3 Packing information

Note: The devices can be packed in tube or tape and reel shipments (see the [Device summary on page 1](#) for packaging quantities).

Figure 46. MultiPowerSO-30 tube shipment (no suffix)

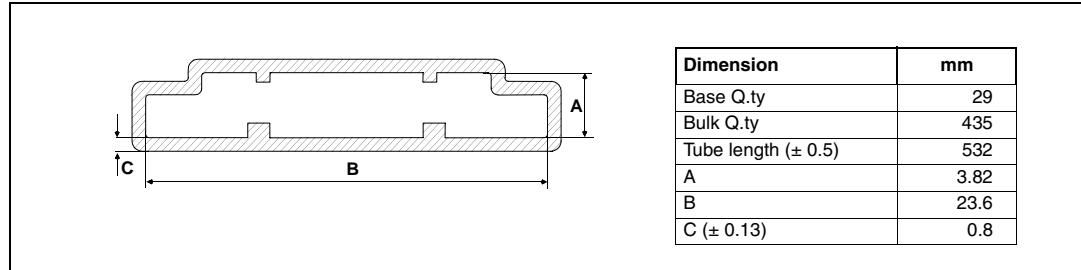
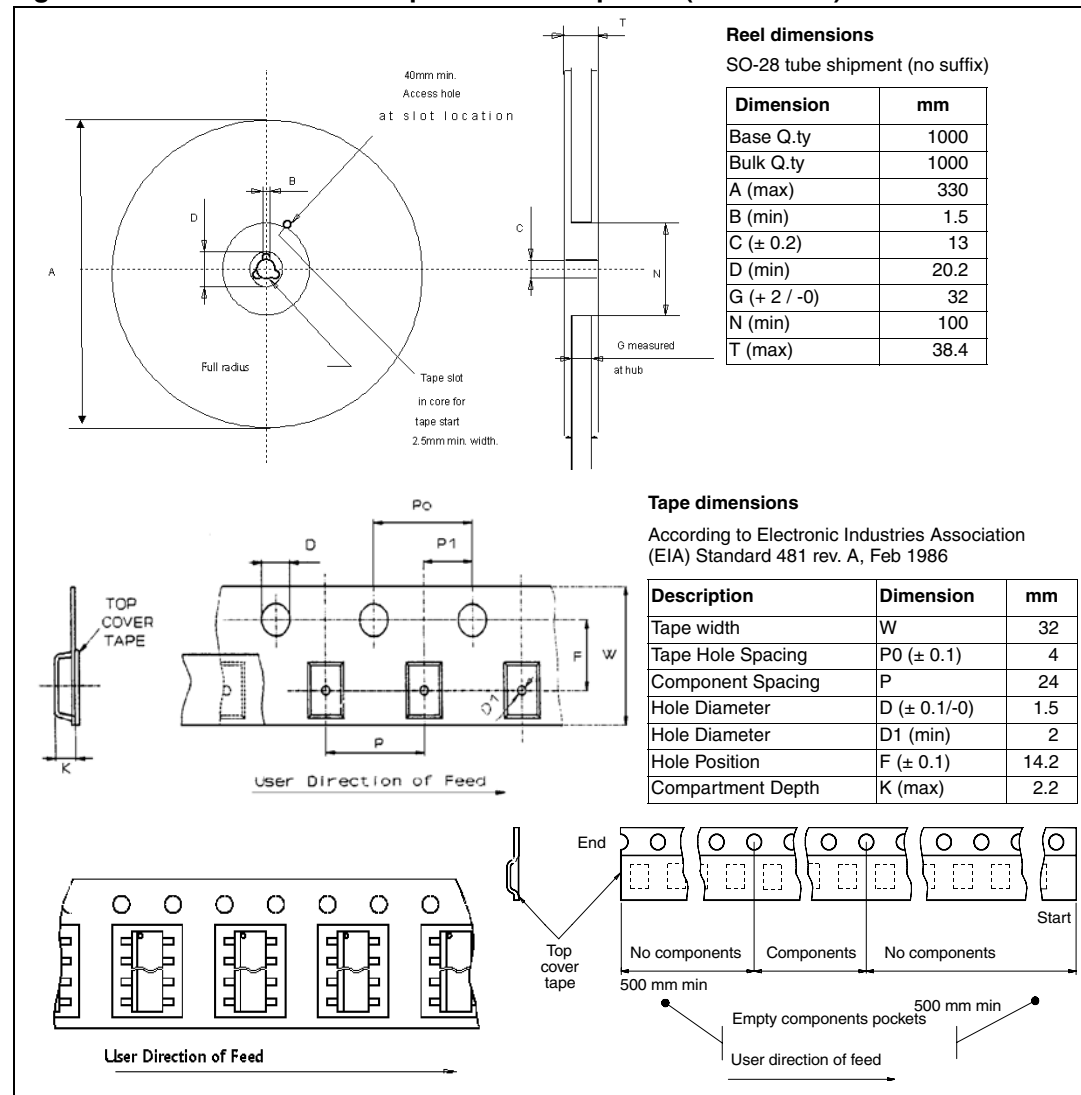

Figure 47. MultiPowerSO-30 tape and reel shipment (suffix “TR”)



6 Revision history

Table 18. Document revision history

Date	Revision	Description of changes
Sep-2004	1	First issue
Dec- 2004	2	Inserted $t_{off(min)}$ test condition modification and note Modified I_{RM} figure number
Feb-2005	3	Minor changes
Apr-2005	4	Public release
01-Sep-2006	5	Document converted into new ST corporate template. Added table of contents, list of tables and list of figures Removed figure number from package outline <i>on page 1</i> Changed <i>Features on page 1</i> to add ECOPACK® package Added <i>Section 1: Block diagram and pin description on page 5</i> Added <i>Section 2.2: Electrical characteristics on page 9</i> Added “low” and “high” to parameters for I_{INL} and I_{INH} in <i>Table 7 on page 9</i> Inserted note in <i>Figure 32 on page 20</i> Added vertical limitation line to left side arrow of $t_{D(off)}$ to <i>Figure 7 on page 13</i> Added <i>Section 4.1: PowerSSO-30 thermal data on page 25</i> Added <i>Section 5: Package and packing information on page 29</i> Added <i>Section 5.3: Packing information on page 31</i> Updated disclaimer (last page) to include a mention about the use of ST products in automotive applications
15-May-2007	6	Document reformatted and converted into new ST template.
06-Feb-2008	7	Corrected Heat Slug numbers in <i>Table 3: Pin definitions and functions</i> .
02-Oct-2008	8	Added new information in <i>Table 6: Power section</i> Added <i>Figure 33: Behavior in fault condition (How a fault can be cleared)</i>

Please Read Carefully:

Information in this document is provided solely in connection with ST products. STMicroelectronics NV and its subsidiaries ("ST") reserve the right to make changes, corrections, modifications or improvements, to this document, and the products and services described herein at any time, without notice.

All ST products are sold pursuant to ST's terms and conditions of sale.

Purchasers are solely responsible for the choice, selection and use of the ST products and services described herein, and ST assumes no liability whatsoever relating to the choice, selection or use of the ST products and services described herein.

No license, express or implied, by estoppel or otherwise, to any intellectual property rights is granted under this document. If any part of this document refers to any third party products or services it shall not be deemed a license grant by ST for the use of such third party products or services, or any intellectual property contained therein or considered as a warranty covering the use in any manner whatsoever of such third party products or services or any intellectual property contained therein.

UNLESS OTHERWISE SET FORTH IN ST'S TERMS AND CONDITIONS OF SALE ST DISCLAIMS ANY EXPRESS OR IMPLIED WARRANTY WITH RESPECT TO THE USE AND/OR SALE OF ST PRODUCTS INCLUDING WITHOUT LIMITATION IMPLIED WARRANTIES OF MERCHANTABILITY, FITNESS FOR A PARTICULAR PURPOSE (AND THEIR EQUIVALENTS UNDER THE LAWS OF ANY JURISDICTION), OR INFRINGEMENT OF ANY PATENT, COPYRIGHT OR OTHER INTELLECTUAL PROPERTY RIGHT.

UNLESS EXPRESSLY APPROVED IN WRITING BY AN AUTHORIZED ST REPRESENTATIVE, ST PRODUCTS ARE NOT RECOMMENDED, AUTHORIZED OR WARRANTED FOR USE IN MILITARY, AIR CRAFT, SPACE, LIFE SAVING, OR LIFE SUSTAINING APPLICATIONS, NOR IN PRODUCTS OR SYSTEMS WHERE FAILURE OR MALFUNCTION MAY RESULT IN PERSONAL INJURY, DEATH, OR SEVERE PROPERTY OR ENVIRONMENTAL DAMAGE. ST PRODUCTS WHICH ARE NOT SPECIFIED AS "AUTOMOTIVE GRADE" MAY ONLY BE USED IN AUTOMOTIVE APPLICATIONS AT USER'S OWN RISK.

Resale of ST products with provisions different from the statements and/or technical features set forth in this document shall immediately void any warranty granted by ST for the ST product or service described herein and shall not create or extend in any manner whatsoever, any liability of ST.

ST and the ST logo are trademarks or registered trademarks of ST in various countries.

Information in this document supersedes and replaces all information previously supplied.

The ST logo is a registered trademark of STMicroelectronics. All other names are the property of their respective owners.

© 2008 STMicroelectronics - All rights reserved

STMicroelectronics group of companies

Australia - Belgium - Brazil - Canada - China - Czech Republic - Finland - France - Germany - Hong Kong - India - Israel - Italy - Japan - Malaysia - Malta - Morocco - Singapore - Spain - Sweden - Switzerland - United Kingdom - United States of America

www.st.com