

TS391, NCV391

Low Power Single Voltage Comparator

Description

The TS391 is an open collector, low-power voltage comparator designed specifically to operate from a single supply over a wide range of voltages. Operation from split power supplies is also possible.

This comparator also has a unique characteristic in that the input common-mode voltage range includes ground, even though operated from a single power supply voltage.

Features

- Wide Single Supply Voltage Range or Dual Supplies
- Low Supply Current (0.5 mA) Independent of Supply Voltage (1 mW/Comparator at +5 V)
- Low Input Bias Current: 25 nA TYP
- Low Input Offset Current: ± 5 nA TYP
- Low Input Offset Voltage: ± 1 mV TYP
- Input Common Mode Voltage Range includes Ground
- Low Output Saturation Voltage: 250 mV TYP at $I_O = 4$ mA
- Differential Input Voltage Range Equal to the Supply Voltage
- TTL, DTL, ECL, CMOS Compatible Devices
- These Devices are Pb-Free, Halogen Free/BFR Free and are RoHS Compliant
- NCV Prefix for Automotive and Other Applications Requiring Unique Site and Control Change Requirements; AEC-Q100 Qualified and PPAP Capable

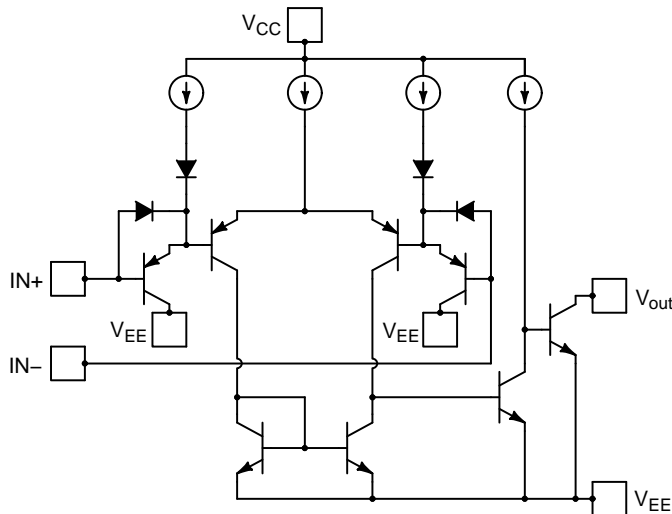

ON Semiconductor®

www.onsemi.com



**TSOP-5
SN SUFFIX
CASE 483**

MARKING DIAGRAM

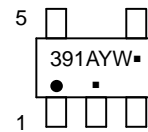

Analog

391 = Specific Device Code
A = Assembly Location
Y = Year
W = Work Week
▪ = Pb-Free Package

(Note: Microdot may be in either location)

PIN CONNECTIONS

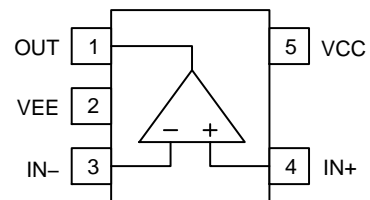

ORDERING INFORMATION

Device	Package	Shipping†
TS391SN2T1G	TSOP-5 (Pb-Free)	3000 / Tape & Reel
NCV391SN2T1G*	TSOP-5 (Pb-Free)	3000 / Tape & Reel

†For information on tape and reel specifications, including part orientation and tape sizes, please refer to our Tape and Reel Packaging Specification Brochure, BRD8011/D.

* NCV Prefix for Automotive and Other Applications Requiring Unique Site and Control Change Requirements; AEC-Q100 Qualified and PPAP Capable

TS391, NCV391

Table 1. ABSOLUTE MAXIMUM RATINGS (Over operating free-air temperature, unless otherwise stated)

Parameter	Symbol	Limit	Unit
Supply Voltage ($V_{CC} - V_{EE}$)	V_S	36	V

INPUT AND OUTPUT PINS

Input Voltage	V_{IN}	-0.3 to 36	V
Differential Input Voltage	V_{ID}	± 36	V
Output Short Circuit Current (Note 1)	I_{SC}	20	mA

TEMPERATURE

Storage Temperature	T_{STG}	-65 to +150	$^{\circ}C$
Junction Temperature	T_J	+150	$^{\circ}C$

ESD RATINGS

Human Body Model	HBM	1500	V
Charged Device Model	CDM	2000	V
Machine Model	MM	200	V

Stresses exceeding those listed in the Maximum Ratings table may damage the device. If any of these limits are exceeded, device functionality should not be assumed, damage may occur and reliability may be affected.

- Short circuits from the output to V_{CC} can cause excessive heating and potential destruction. The maximum short circuit current is independent of the magnitude of V_{CC} .

Table 2. THERMAL INFORMATION (Note 2)

Thermal Metric	Symbol	Limit	Unit
Junction to Ambient – SOIC8	θ_{JA}	238	$^{\circ}C/W$

- Short-circuits can cause excessive heating and destructive dissipation. These values are typical.

Table 3. OPERATING CONDITIONS

Parameter	Symbol	Limit	Unit
Operating Supply Voltage	V_S	2 to 36	V
Specified Operating Range	T_A	-40 to +125	$^{\circ}C$

Functional operation above the stresses listed in the Recommended Operating Ranges is not implied. Extended exposure to stresses beyond the Recommended Operating Ranges limits may affect device reliability.

TS391, NCV391

Table 4. ELECTRICAL CHARACTERISTICS (Vs=+5.0 V, At TA = +25°C)
Boldface limits apply over the specified temperature range, TA = -40°C to +125°C.

Parameter	Symbol	Test Conditions	Min	Typ	Max	Unit	
INPUT CHARACTERISTICS							
Offset Voltage	V _{OS}	V _O = 1.4 V, R _S = 0 Ω, V _S = 5 V to 30 V	V _{CM} = 0 to V _{CC} -1.5 V		1	5	mV
			V _{CM} = 0 to V _{CC} -2 V			9	mV
Input Bias Current	I _{IB}			25	250	nA	
					400	nA	
Input Offset Current	I _{OS}			5	50	nA	
					150	nA	
Input Common Mode Range (Note 3)	V _{ICR}		0		V _{CC} - 1.5	V	
			0		V_{CC} - 2	V	
Differential Input Voltage (Note 4)	V _{ID}				V _{CC}	V	
OUTPUT CHARACTERISTICS							
Output Voltage Low	V _{OL}	V _{ID} = 1 V, I _O = 4 mA		250	400	mV	
					700	mV	
Output Sink Current	I _O	V _{ID} = -1, V _O = 1.5 V	6	16		mA	
Output Leakage Current	I _{OH}	V _{ID} = 1 V, V _{CC} = V _O = 5 V		0.1		nA	
		V _{ID} = 1 V, V _{CC} = V _O = 30 V			1	μA	
DYNAMIC PERFORMANCE							
Open Loop Voltage Gain	A _{VOL}	V _{CC} = 15 V, R _{PU} = 15 kΩ	94	106		dB	
Propagation Delay L-H	t _{PLH}	5 mV overdrive, R _{PU} = 5.1 kΩ		850		ns	
		20 mV overdrive, R _{PU} = 5.1 kΩ		490		ns	
		100 mV overdrive, R _{PU} = 5.1 kΩ		300		ns	
		TTL Input, V _{ref} = +1.4 V, R _{PU} = 5.1 kΩ		220		ns	
Propagation Delay H-L	t _{PHL}	5 mV overdrive, R _{PU} = 5.1 kΩ		620		ns	
		20 mV overdrive, R _{PU} = 5.1 kΩ		400		ns	
		100 mV overdrive, R _{PU} = 5.1 kΩ		250		ns	
		TTL Input, V _{ref} = +1.4 V, R _{PU} = 5.1 kΩ		350		ns	
POWER SUPPLY							
Quiescent Current	I _{CC}	V _{CC} = 5 V		0.5	-	mA	
		V _{CC} = 30 V		0.5	1.25	mA	

Product parametric performance is indicated in the Electrical Characteristics for the listed test conditions, unless otherwise noted. Product performance may not be indicated by the Electrical Characteristics if operated under different conditions.

- The input common mode voltage of either input signal should not be allowed to go negative by more than 0.3 V. The upper end of the common mode voltage range is V_{CC} - 1.5 V, but either or both inputs can go to +30 V without damage.
- Positive excursions of the input voltage may exceed the power supply level. As long as the other voltage remains within the common mode range, the comparator will provide a proper output stage. The low input voltage state must not be less than 0.3 V below the negative supply rail.

TS391, NCV391

TYPICAL CHARACTERISTICS

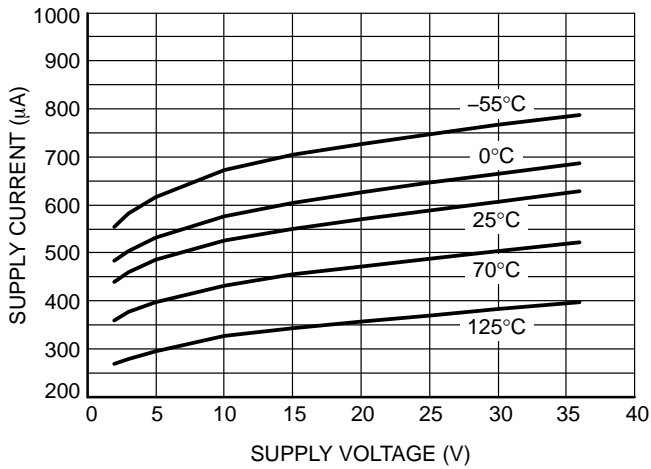

Figure 1. Supply Current vs. Supply Voltage

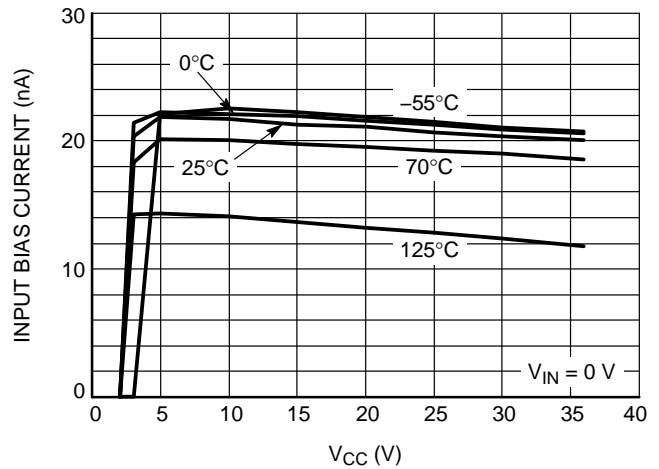

Figure 2. Input Bias Current vs. V_{CC}

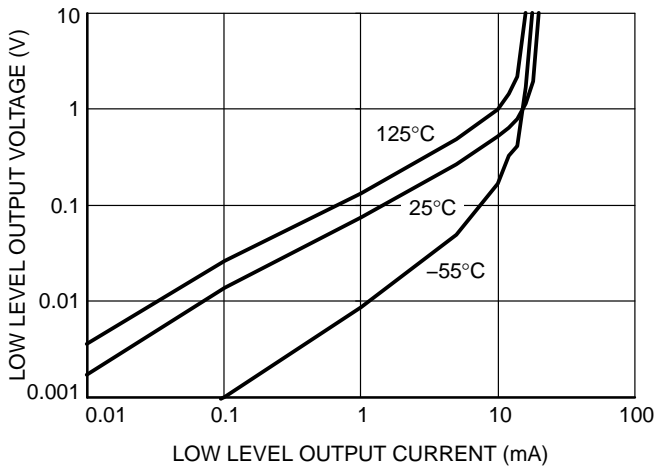

Figure 3. Low Level Output Voltage vs. Output Current

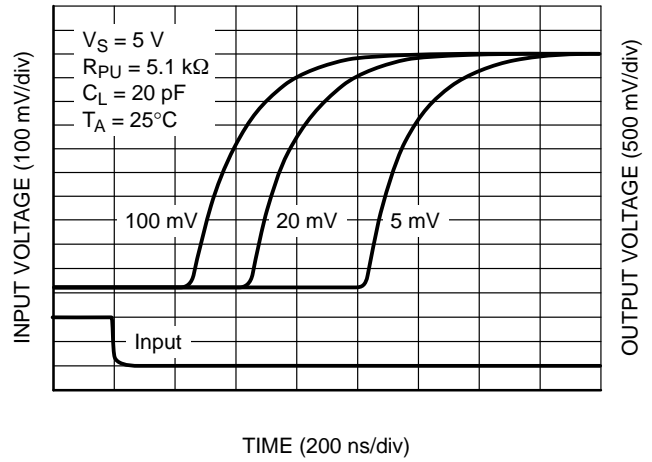

Figure 4. Propagation Delay L-H vs. Overdrive

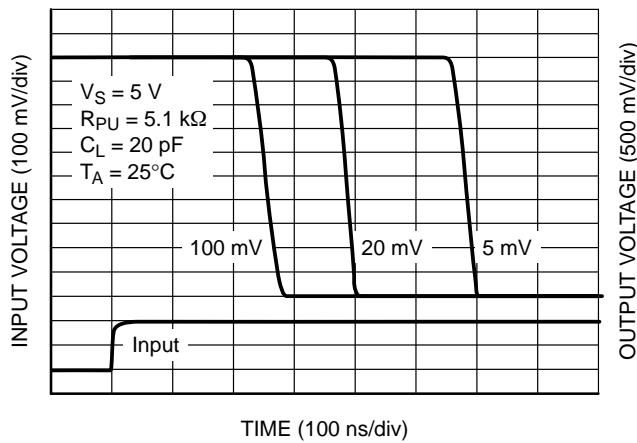
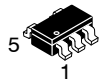

Figure 5. Propagation Delay H-L vs. Overdrive

MECHANICAL CASE OUTLINE PACKAGE DIMENSIONS

ON Semiconductor®



SCALE 2:1

TSOP-5 CASE 483 ISSUE N

DATE 12 AUG 2020

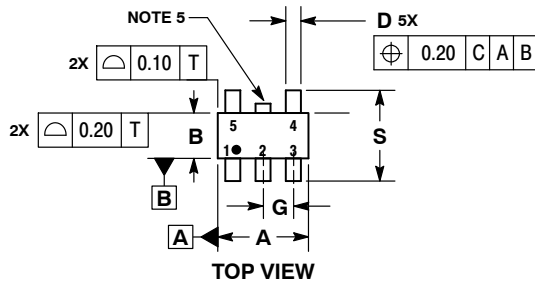

NOTES:

1. DIMENSIONING AND TOLERANCING PER ASME Y14.5M, 1994.
2. CONTROLLING DIMENSION: MILLIMETERS.
3. MAXIMUM LEAD THICKNESS INCLUDES LEAD FINISH THICKNESS. MINIMUM LEAD THICKNESS IS THE MINIMUM THICKNESS OF BASE MATERIAL.
4. DIMENSIONS A AND B DO NOT INCLUDE MOLD FLASH, PROTRUSIONS, OR GATE BURRS. MOLD FLASH, PROTRUSIONS, OR GATE BURRS SHALL NOT EXCEED 0.15 PER SIDE. DIMENSION A.
5. OPTIONAL CONSTRUCTION: AN ADDITIONAL TRIMMED LEAD IS ALLOWED IN THIS LOCATION. TRIMMED LEAD NOT TO EXTEND MORE THAN 0.2 FROM BODY.

DIM	MILLIMETERS	
	MIN	MAX
A	2.85	3.15
B	1.35	1.65
C	0.90	1.10
D	0.25	0.50
G	0.95 BSC	
H	0.01	0.10
J	0.10	0.26
K	0.20	0.60
M	0°	10°
S	2.50	3.00

SOLDERING FOOTPRINT*

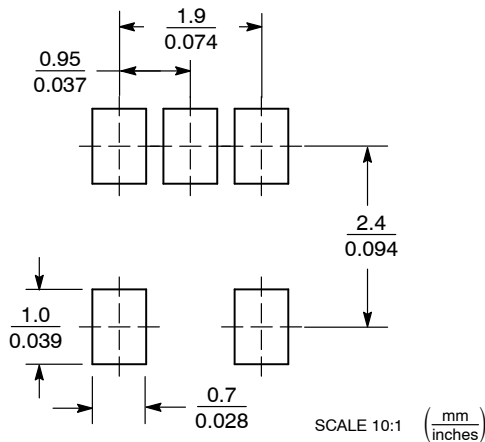

*For additional information on our Pb-Free strategy and soldering details, please download the ON Semiconductor Soldering and Mounting Techniques Reference Manual, SOLDERRM/D.

GENERIC MARKING DIAGRAM*



- XXX = Specific Device Code
 A = Assembly Location
 Y = Year
 W = Work Week
 ■ = Pb-Free Package
- XXX = Specific Device Code
 M = Date Code
 ■ = Pb-Free Package

(Note: Microdot may be in either location)

*This information is generic. Please refer to device data sheet for actual part marking. Pb-Free indicator, "G" or microdot "■", may or may not be present.

DOCUMENT NUMBER:	98ARB18753C	Electronic versions are uncontrolled except when accessed directly from the Document Repository. Printed versions are uncontrolled except when stamped "CONTROLLED COPY" in red.
DESCRIPTION:	TSOP-5	PAGE 1 OF 1

ON Semiconductor and ON are trademarks of Semiconductor Components Industries, LLC dba ON Semiconductor or its subsidiaries in the United States and/or other countries. ON Semiconductor reserves the right to make changes without further notice to any products herein. ON Semiconductor makes no warranty, representation or guarantee regarding the suitability of its products for any particular purpose, nor does ON Semiconductor assume any liability arising out of the application or use of any product or circuit, and specifically disclaims any and all liability, including without limitation special, consequential or incidental damages. ON Semiconductor does not convey any license under its patent rights nor the rights of others.

onsemi, **Onsemi**, and other names, marks, and brands are registered and/or common law trademarks of Semiconductor Components Industries, LLC dba "**onsemi**" or its affiliates and/or subsidiaries in the United States and/or other countries. **onsemi** owns the rights to a number of patents, trademarks, copyrights, trade secrets, and other intellectual property. A listing of **onsemi**'s product/patent coverage may be accessed at www.onsemi.com/site/pdf/Patent-Marking.pdf. **onsemi** reserves the right to make changes at any time to any products or information herein, without notice. The information herein is provided "as-is" and **onsemi** makes no warranty, representation or guarantee regarding the accuracy of the information, product features, availability, functionality, or suitability of its products for any particular purpose, nor does **onsemi** assume any liability arising out of the application or use of any product or circuit, and specifically disclaims any and all liability, including without limitation special, consequential or incidental damages. Buyer is responsible for its products and applications using **onsemi** products, including compliance with all laws, regulations and safety requirements or standards, regardless of any support or applications information provided by **onsemi**. "Typical" parameters which may be provided in **onsemi** data sheets and/or specifications can and do vary in different applications and actual performance may vary over time. All operating parameters, including "Typicals" must be validated for each customer application by customer's technical experts. **onsemi** does not convey any license under any of its intellectual property rights nor the rights of others. **onsemi** products are not designed, intended, or authorized for use as a critical component in life support systems or any FDA Class 3 medical devices or medical devices with a same or similar classification in a foreign jurisdiction or any devices intended for implantation in the human body. Should Buyer purchase or use **onsemi** products for any such unintended or unauthorized application, Buyer shall indemnify and hold **onsemi** and its officers, employees, subsidiaries, affiliates, and distributors harmless against all claims, costs, damages, and expenses, and reasonable attorney fees arising out of, directly or indirectly, any claim of personal injury or death associated with such unintended or unauthorized use, even if such claim alleges that **onsemi** was negligent regarding the design or manufacture of the part. **onsemi** is an Equal Opportunity/Affirmative Action Employer. This literature is subject to all applicable copyright laws and is not for resale in any manner.

PUBLICATION ORDERING INFORMATION

LITERATURE FULFILLMENT:

Email Requests to: orderlit@onsemi.com

onsemi Website: www.onsemi.com

TECHNICAL SUPPORT

North American Technical Support:
Voice Mail: 1 800-282-9855 Toll Free USA/Canada
Phone: 011 421 33 790 2910

Europe, Middle East and Africa Technical Support:

Phone: 00421 33 790 2910

For additional information, please contact your local Sales Representative