

## Low-Noise, Wide-Bandwidth, High PSRR, Low-Dropout 1-A Linear Regulator

### FEATURES

- Low-Dropout 1-A Regulator with Enable
- Adjustable Output Voltage: 0.8 V to 6.0 V
- Wide-Bandwidth High PSRR:
  - 80 dB at 1 kHz
  - 60 dB at 100 kHz
  - 54 dB at 1 MHz
- Low Noise: 23.5  $\mu\text{V}_{\text{RMS}}$  typical (100 Hz to 100 kHz)
- Stable with a 4.7- $\mu\text{F}$  Capacitance
- Excellent Load/Line Transient Response
- 3% Overall Accuracy (over Load/Line/Temperature)
- Over-Current and Over-Temperature Protection
- Very Low Dropout: 170 mV Typical at 1 A
- Package: 3-mm x 3-mm SON-8

### APPLICATIONS

- Telecom Infrastructure
- Audio
- High-Speed I/F (PLL/VCO)

DRB PACKAGE  
3mm x 3mm SON  
(TOP VIEW)

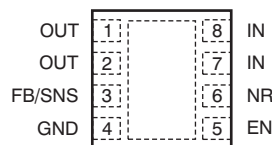

### DESCRIPTION

The TPS7A8101 low-dropout linear regulator (LDO) offers very good performance in noise and power-supply rejection ratio (PSRR) at the output. This LDO uses an advanced BiCMOS process and a PMOSFET pass device to achieve very low noise, excellent transient response, and excellent PSRR performance.

The TPS7A8101 is stable with a 4.7- $\mu\text{F}$  ceramic output capacitor, and uses a precision voltage reference and feedback loop to achieve a worst-case accuracy of 3% over all load, line, process, and temperature variations.

This device is fully specified over the temperature range of  $T_J = -40^\circ\text{C}$  to  $+125^\circ\text{C}$  and is offered in a 3-mm x 3-mm, SON-8 package with a thermal pad.

Typical Application Circuit

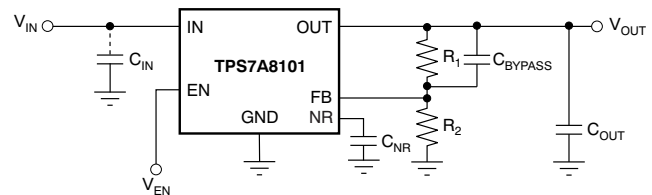

TYPICAL POWER-SUPPLY RIPPLE REJECTION

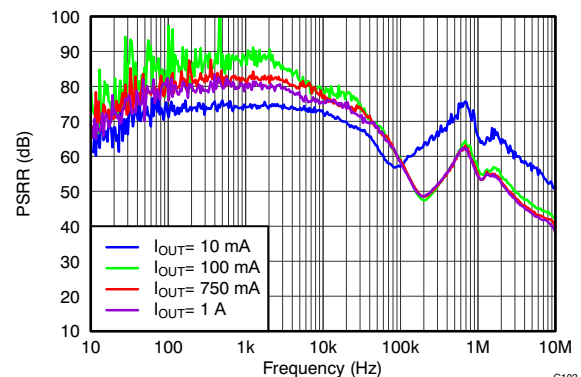

G103



Please be aware that an important notice concerning availability, standard warranty, and use in critical applications of Texas Instruments semiconductor products and disclaimers thereto appears at the end of this data sheet.

All trademarks are the property of their respective owners.



This integrated circuit can be damaged by ESD. Texas Instruments recommends that all integrated circuits be handled with appropriate precautions. Failure to observe proper handling and installation procedures can cause damage.

ESD damage can range from subtle performance degradation to complete device failure. Precision integrated circuits may be more susceptible to damage because very small parametric changes could cause the device not to meet its published specifications.

### ORDERING INFORMATION<sup>(1)</sup>

PRODUCT	V <sub>OUT</sub>
TPS7A8101yyyz	YYY is package designator. Z is package quantity.

(1) For the most current package and ordering information see the Package Option Addendum at the end of this document, or visit the device product folder on [www.ti.com](http://www.ti.com).

### ABSOLUTE MAXIMUM RATINGS

Over operating free-air temperature range (unless otherwise noted).<sup>(1)</sup>

		VALUE		UNIT
		MIN	MAX	
Voltage	IN	-0.3	+7.0	V
	FB, NR	-0.3	+3.6	V
	EN	-0.3	V <sub>IN</sub> + 0.3 <sup>(2)</sup>	V
	OUT	-0.3	+7.0	V
Current	OUT	Internally Limited		A
Temperature	Operating virtual junction, T <sub>J</sub>	-55	+150	°C
	Storage, T <sub>stg</sub>	-55	+150	°C
Electrostatic discharge (ESD) rating <sup>(3)</sup>	Human body model (HBM) QSS 009-105 (JESD22-A114A)	2		kV
	Charged device model (CDM) QSS 009-147 (JESD22-C101B.01)	500		V

- (1) Stresses beyond those listed under *Absolute Maximum Ratings* may cause permanent damage to the device. These are stress ratings only, and functional operation of the device at these or any other conditions beyond those indicated is not implied. Exposure to absolute-maximum-rated conditions for extended periods may affect device reliability.
- (2) V<sub>EN</sub> absolute maximum rating is V<sub>IN</sub> + 0.3 V or +7.0 V, whichever is smaller.
- (3) ESD testing is performed according to the respective JESD22 JEDEC standard.

**THERMAL INFORMATION**

THERMAL METRIC <sup>(1)(2)</sup>		TPS7A8101	UNITS
		DRB <sup>(3)</sup>	
		8 PINS	
$\theta_{JA}$	Junction-to-ambient thermal resistance <sup>(4)</sup>	45.7	°C/W
$\theta_{JCTop}$	Junction-to-case (top) thermal resistance <sup>(5)</sup>	53.2	
$\theta_{JB}$	Junction-to-board thermal resistance <sup>(6)</sup>	21.3	
$\psi_{JT}$	Junction-to-top characterization parameter <sup>(7)</sup>	0.9	
$\psi_{JB}$	Junction-to-board characterization parameter <sup>(8)</sup>	21.4	
$\theta_{JCbott}$	Junction-to-case (bottom) thermal resistance <sup>(9)</sup>	5.2	

- (1) For more information about traditional and new thermal metrics, see the [IC Package Thermal Metrics application report, SPRA953A](#).
- (2) For thermal estimates of this device based on PCB copper area, see the [TI PCB Thermal Calculator](#).
- (3) Thermal data for the DRB package are derived by thermal simulations based on JEDEC-standard methodology as specified in the JESD51 series. The following assumptions are used in the simulations:
  - (a) The exposed pad is connected to the PCB ground layer through a 2x2 thermal via array.
  - (b) The top and bottom copper layers are assumed to have a 5% thermal conductivity of copper representing a 20% copper coverage.
  - (c) This data were generated with only a single device at the center of a JEDEC high-K (2s2p) board with 3in x 3in copper area. To understand the effects of the copper area on thermal performance, refer to the [Power Dissipation](#) and [Estimating Junction Temperature](#) sections.
- (4) The junction-to-ambient thermal resistance under natural convection is obtained in a simulation on a JEDEC-standard, high-K board, as specified in JESD51-7, in an environment described in JESD51-2a.
- (5) The junction-to-case (top) thermal resistance is obtained by simulating a cold plate test on the top of the package. No specific JEDEC-standard test exists, but a close description can be found in the ANSI SEMI standard G30-88.
- (6) The junction-to-board thermal resistance is obtained by simulating in an environment with a ring cold plate fixture to control the PCB temperature, as described in JESD51-8.
- (7) The junction-to-top characterization parameter,  $\psi_{JT}$ , estimates the junction temperature of a device in a real system and is extracted from the simulation data to obtain  $\theta_{JA}$  using a procedure described in JESD51-2a (sections 6 and 7).
- (8) The junction-to-board characterization parameter,  $\psi_{JB}$ , estimates the junction temperature of a device in a real system and is extracted from the simulation data to obtain  $\theta_{JA}$  using a procedure described in JESD51-2a (sections 6 and 7).
- (9) The junction-to-case (bottom) thermal resistance is obtained by simulating a cold plate test on the exposed (power) pad. No specific JEDEC standard test exists, but a close description can be found in the ANSI SEMI standard G30-88.

## ELECTRICAL CHARACTERISTICS

Over the operating temperature range of  $T_J = -40^\circ\text{C}$  to  $+125^\circ\text{C}$ ,  $V_{IN} = V_{OUT(TYP)} + 0.5\text{ V}$  or  $2.2\text{ V}$  (whichever is greater),  $I_{OUT} = 1\text{ mA}$ ,  $V_{EN} = 2.2\text{ V}$ ,  $C_{OUT} = 4.7\text{ }\mu\text{F}$ ,  $C_{NR} = 0.01\text{ }\mu\text{F}$ , and  $C_{BYPASS} = 0\text{ }\mu\text{F}$ , unless otherwise noted. TPS7A8101 is tested at  $V_{OUT} = 0.8\text{ V}$  and  $V_{OUT} = 6.0\text{ V}$ . Typical values are at  $T_J = +25^\circ\text{C}$ .

PARAMETER	TEST CONDITIONS	TPS7A8101			UNIT	
		MIN	TYP	MAX		
$V_{IN}$	Input voltage range <sup>(1)</sup>	2.2		6.5	V	
$V_{NR}$	Internal reference	0.790	0.800	0.810	V	
$V_{OUT}$	Output voltage range	0.8		6.0	V	
	Output accuracy <sup>(2)</sup>	$V_{OUT} + 0.5\text{ V} \leq V_{IN} \leq 6.0\text{ V}$ , $V_{IN} \geq 2.5\text{ V}$ , $100\text{ mA} \leq I_{OUT} \leq 500\text{ mA}$ , $0^\circ\text{C} \leq T_J \leq 85^\circ\text{C}$	-2.0		+2.0	%
		$V_{OUT} + 0.5\text{ V} \leq V_{IN} \leq 6.5\text{ V}$ , $V_{IN} \geq 2.2\text{ V}$ , $100\text{ mA} \leq I_{OUT} \leq 1\text{ A}$	-3.0	$\pm 0.3$	+3.0	%
$\Delta V_{O(\Delta VI)}$	Line regulation	$V_{OUT(NOM)} + 0.5\text{ V} \leq V_{IN} \leq 6.5\text{ V}$ , $V_{IN} \geq 2.2\text{ V}$ , $I_{OUT} = 100\text{ mA}$		150		$\mu\text{V/V}$
$\Delta V_{O(\Delta IL)}$	Load regulation	$100\text{ mA} \leq I_{OUT} \leq 1\text{ A}$		2		$\mu\text{V/mA}$
$V_{DO}$	Dropout voltage <sup>(3)</sup>	$V_{OUT} + 0.5\text{ V} \leq V_{IN} \leq 6.5\text{ V}$ , $V_{IN} \geq 2.2\text{ V}$ , $I_{OUT} = 500\text{ mA}$ , $V_{FB} = \text{GND}$ or $V_{SNS} = \text{GND}$			250	mV
		$V_{OUT} + 0.5\text{ V} \leq V_{IN} \leq 6.5\text{ V}$ , $V_{IN} \geq 2.5\text{ V}$ , $I_{OUT} = 750\text{ mA}$ , $V_{FB} = \text{GND}$ or $V_{SNS} = \text{GND}$			350	mV
		$V_{OUT} + 0.5\text{ V} \leq V_{IN} \leq 6.5\text{ V}$ , $V_{IN} \geq 2.5\text{ V}$ , $I_{OUT} = 1\text{ A}$ , $V_{FB} = \text{GND}$ or $V_{SNS} = \text{GND}$			500	mV
$I_{LIM}$	Output current limit	$V_{OUT} = 0.85 \times V_{OUT(NOM)}$ , $V_{IN} \geq 3.3\text{ V}$	1100	1400	2000	mA
$I_{GND}$	Ground pin current	$I_{OUT} = 1\text{ mA}$		60	100	$\mu\text{A}$
		$I_{OUT} = 1\text{ A}$			350	$\mu\text{A}$
$I_{SHDN}$	Shutdown current ( $I_{GND}$ )	$V_{EN} \leq 0.4\text{ V}$ , $V_{IN} \geq 2.2\text{ V}$ , $R_L = 1\text{ k}\Omega$ , $0^\circ\text{C} \leq T_J \leq 85^\circ\text{C}$		0.20	2	$\mu\text{A}$
$I_{FB}$	Feedback pin current	$V_{IN} = 6.5\text{ V}$ , $V_{FB} = 0.8\text{ V}$		0.02	1.0	$\mu\text{A}$
PSRR	Power-supply rejection ratio	$V_{IN} = 4.3\text{ V}$ , $V_{OUT} = 3.3\text{ V}$ , $I_{OUT} = 750\text{ mA}$	$f = 100\text{ Hz}$		80	dB
			$f = 1\text{ kHz}$		82	dB
			$f = 10\text{ kHz}$		78	dB
			$f = 100\text{ kHz}$		60	dB
			$f = 1\text{ MHz}$		54	dB
$V_n$	Output noise voltage	$BW = 100\text{ Hz to }100\text{ kHz}$ , $V_{IN} = 3.8\text{ V}$ , $V_{OUT} = 3.3\text{ V}$ , $I_{OUT} = 100\text{ mA}$ , $C_{NR} = C_{BYPASS} = 470\text{ nF}$		23.5		$\mu\text{V}_{RMS}$
$V_{EN(HI)}$	Enable high (enabled)	$2.2\text{ V} \leq V_{IN} \leq 3.6\text{ V}$ , $R_L = 1\text{ k}\Omega$	1.2			V
		$3.6\text{ V} < V_{IN} \leq 6.5\text{ V}$ , $R_L = 1\text{ k}\Omega$	1.35			V
$V_{EN(LO)}$	Enable low (shutdown)	$R_L = 1\text{ k}\Omega$	0		0.4	V
$I_{EN(HI)}$	Enable pin current, enabled	$V_{IN} = V_{EN} = 6.5\text{ V}$		0.02	1.0	$\mu\text{A}$
$t_{STR}$	Startup time	$V_{OUT(NOM)} = 3.3\text{ V}$ , $V_{OUT} = 0\%$ to $90\% V_{OUT(NOM)}$ , $R_L = 3.3\text{ k}\Omega$ , $C_{OUT} = 10\text{ }\mu\text{F}$ , $C_{NR} = 470\text{ nF}$		80		ms
UVLO	Undervoltage lockout	$V_{IN}$ rising, $R_L = 1\text{ k}\Omega$	1.86	2	2.10	V
	Hysteresis	$V_{IN}$ falling, $R_L = 1\text{ k}\Omega$		75		mV
$T_{SD}$	Thermal shutdown temperature	Shutdown, temperature increasing		+160		$^\circ\text{C}$
		Reset, temperature decreasing		+140		$^\circ\text{C}$
$T_J$	Operating junction temperature		-40		+125	$^\circ\text{C}$

(1) Minimum  $V_{IN} = V_{OUT} + V_{DO}$  or  $2.2\text{ V}$ , whichever is greater.

(2) The TPS7A8101 does not include external resistor tolerances and it is not tested at this condition:  $V_{OUT} = 0.8\text{ V}$ ,  $4.5\text{ V} \leq V_{IN} \leq 6.5\text{ V}$ , and  $750\text{ mA} \leq I_{OUT} \leq 1\text{ A}$  because the power dissipation is greater than the maximum rating of the package.

(3)  $V_{DO}$  is not measured for fixed output voltage devices with  $V_{OUT} < 1.7\text{ V}$  because minimum  $V_{IN} = 2.2\text{ V}$ .

FUNCTIONAL BLOCK DIAGRAM

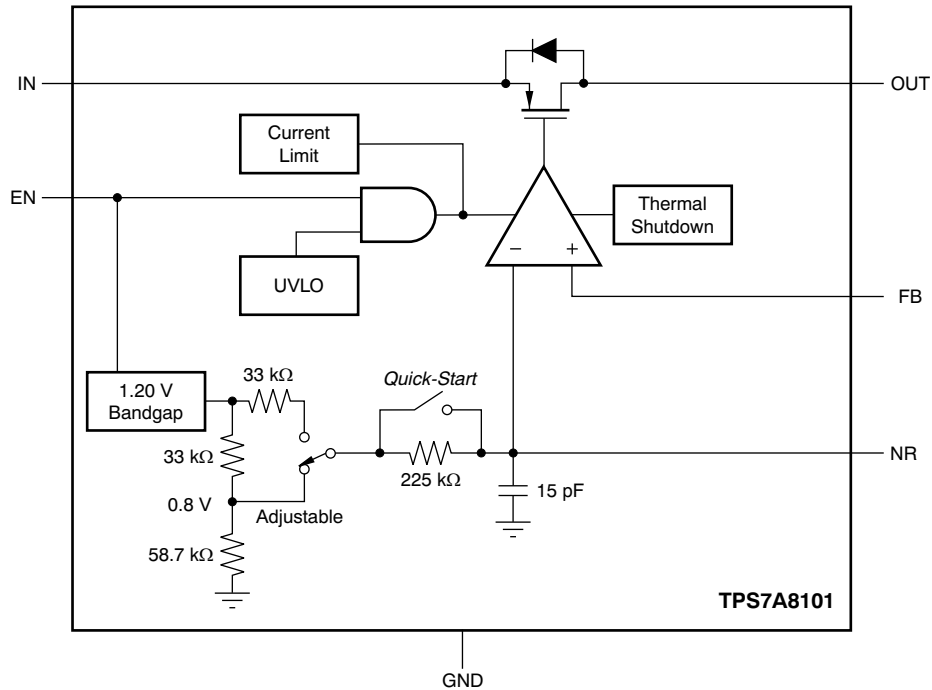
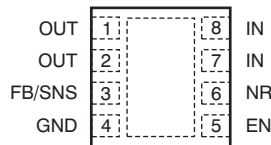

Figure 1. Functional Block Diagram

PIN CONFIGURATION

DRB PACKAGE  
3mm x 3mm SON-8  
(TOP VIEW)



PIN DESCRIPTIONS

PIN		DESCRIPTION
NAME	NO.	
EN	5	Driving this pin high turns on the regulator. Driving this pin low puts the regulator into shutdown mode. Refer to the <i>Shutdown</i> section for more details. EN must not be left floating and can be connected to IN if not used.
FB	3	This pin is the input to the control-loop error amplifier and is used to set the output voltage of the device.
GND	4, pad	Ground
IN	7, 8	Unregulated input supply
NR	6	Connect an external capacitor between this pin and ground to reduce output noise to very low levels. The capacitor also slows down the V <sub>OUT</sub> ramp (RC softstart).
OUT	1, 2	Regulator output. A 4.7-μF or larger capacitor of any type is required for stability.

**TYPICAL CHARACTERISTICS: TPS7A8101**

At  $V_{OUT(TYP)} = 3.3\text{ V}$ ,  $V_{IN} = V_{OUT(TYP)} + 0.5\text{ V}$  or  $2.2\text{ V}$  (whichever is greater),  $I_{OUT} = 100\text{ mA}$ ,  $V_{EN} = V_{IN}$ ,  $C_{IN} = 1\text{ }\mu\text{F}$ ,  $C_{OUT} = 4.7\text{ }\mu\text{F}$ , and  $C_{NR} = 0.01\text{ }\mu\text{F}$ ; all temperature values refer to  $T_J$ , unless otherwise noted.

**LOAD REGULATION**

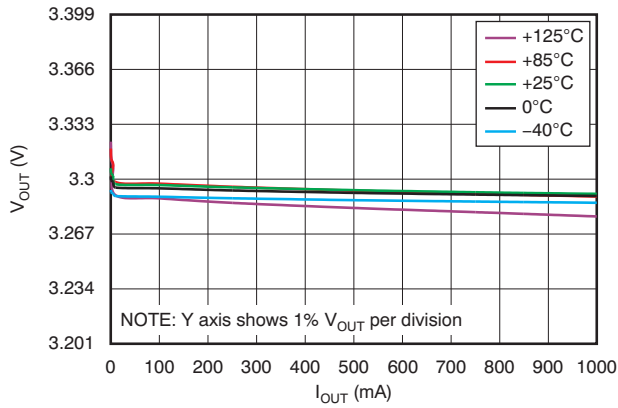

**Figure 2.**

**LOAD REGULATION UNDER LIGHT LOADS**

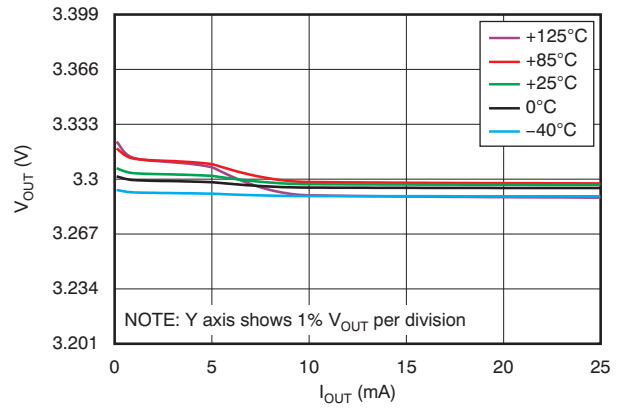

**Figure 3.**

**LINE REGULATION**

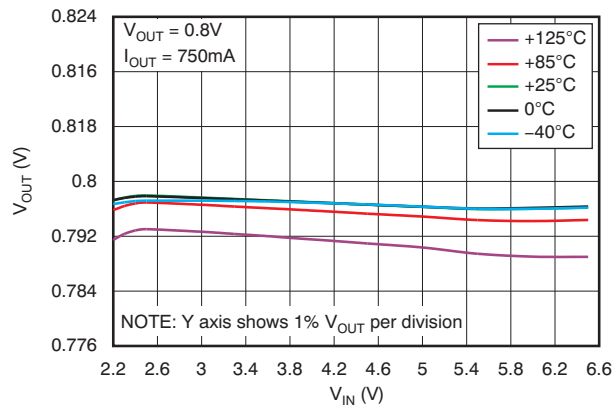

**Figure 4.**

**LINE REGULATION UNDER LIGHT LOADS**

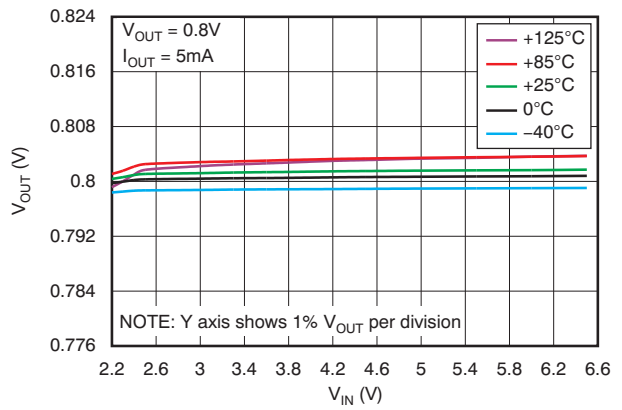
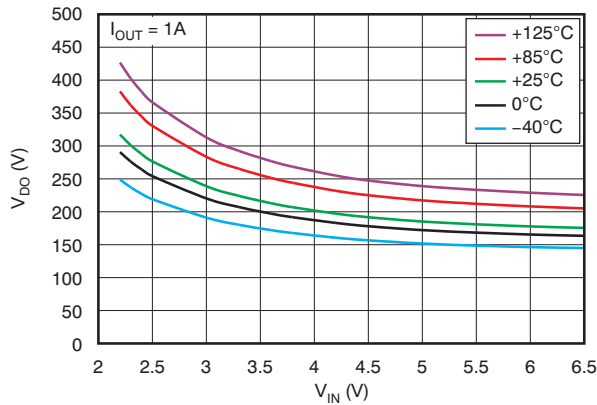

**Figure 5.**

**TYPICAL CHARACTERISTICS: TPS7A8101 (continued)**

At  $V_{OUT(TYP)} = 3.3\text{ V}$ ,  $V_{IN} = V_{OUT(TYP)} + 0.5\text{ V}$  or  $2.2\text{ V}$  (whichever is greater),  $I_{OUT} = 100\text{ mA}$ ,  $V_{EN} = V_{IN}$ ,  $C_{IN} = 1\text{ }\mu\text{F}$ ,  $C_{OUT} = 4.7\text{ }\mu\text{F}$ , and  $C_{NR} = 0.01\text{ }\mu\text{F}$ ; all temperature values refer to  $T_J$ , unless otherwise noted.

**DROPOUT VOLTAGE vs INPUT VOLTAGE**



**Figure 6.**

**DROPOUT VOLTAGE vs INPUT VOLTAGE**

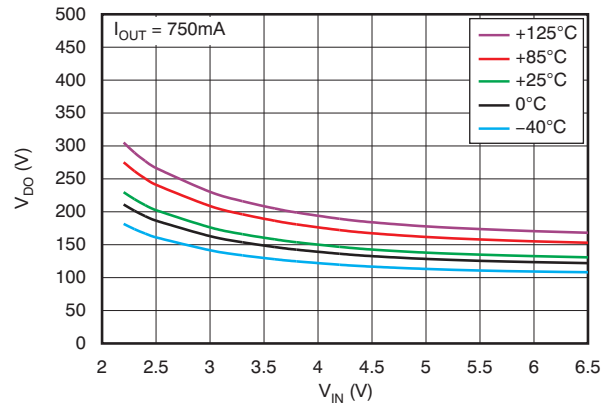

**Figure 7.**

**DROPOUT VOLTAGE vs INPUT VOLTAGE**

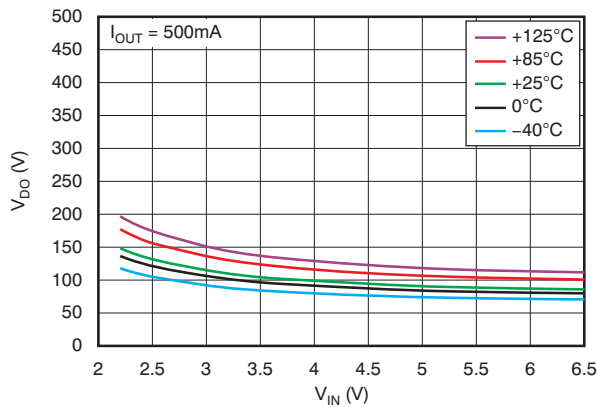

**Figure 8.**

**DROPOUT VOLTAGE vs LOAD CURRENT**

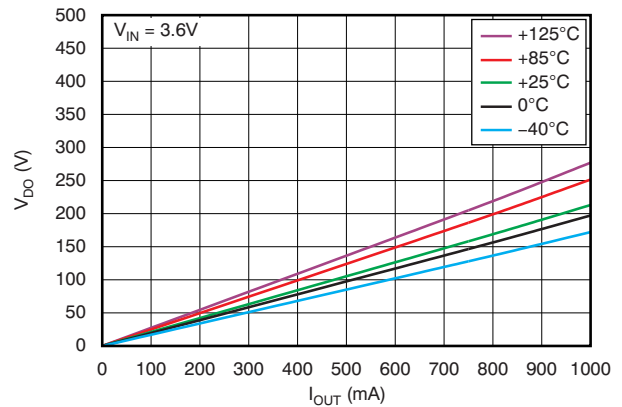

**Figure 9.**

**DROPOUT VOLTAGE vs TEMPERATURE**

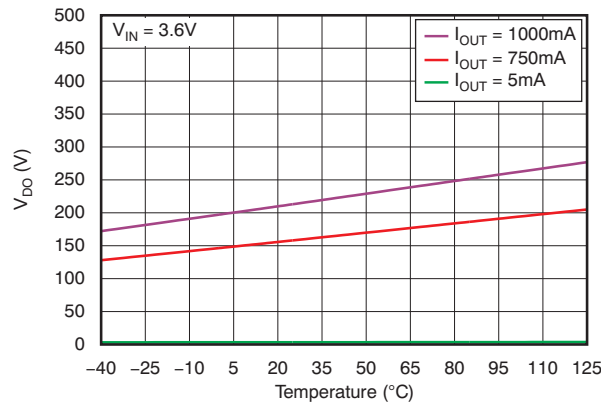

**Figure 10.**

**TYPICAL CHARACTERISTICS: TPS7A8101 (continued)**

At  $V_{OUT(TYP)} = 3.3\text{ V}$ ,  $V_{IN} = V_{OUT(TYP)} + 0.5\text{ V}$  or  $2.2\text{ V}$  (whichever is greater),  $I_{OUT} = 100\text{ mA}$ ,  $V_{EN} = V_{IN}$ ,  $C_{IN} = 1\text{ }\mu\text{F}$ ,  $C_{OUT} = 4.7\text{ }\mu\text{F}$ , and  $C_{NR} = 0.01\text{ }\mu\text{F}$ ; all temperature values refer to  $T_J$ , unless otherwise noted.

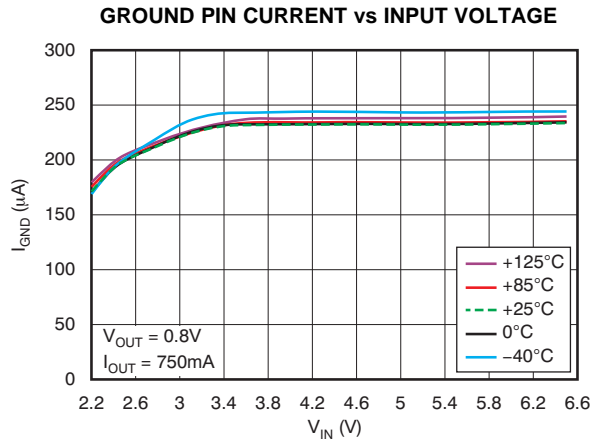

Figure 11.

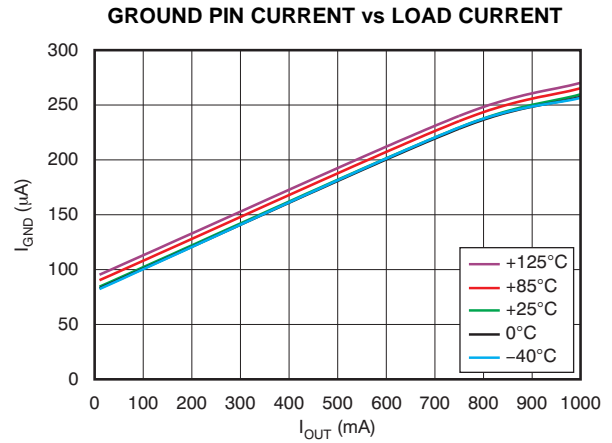

Figure 12.

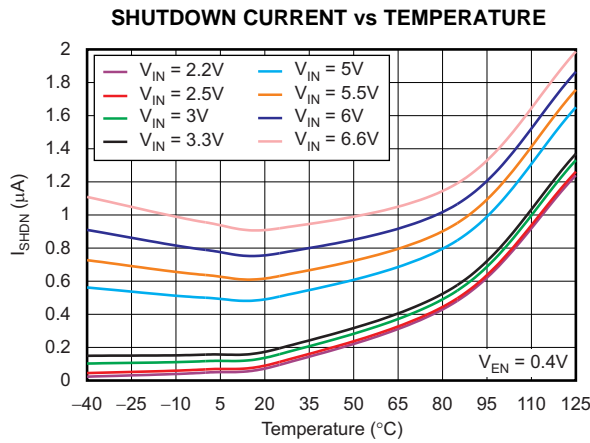

Figure 13.

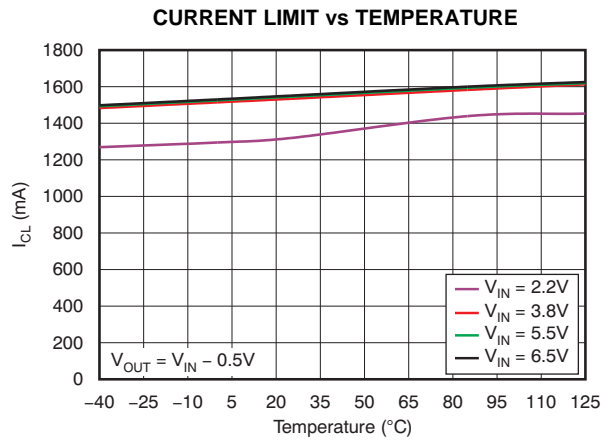

Figure 14.



**TYPICAL CHARACTERISTICS: TPS7A8101 (continued)**

At  $V_{OUT(TYP)} = 3.3\text{ V}$ ,  $V_{IN} = V_{OUT(TYP)} + 0.5\text{ V}$  or  $2.2\text{ V}$  (whichever is greater),  $I_{OUT} = 100\text{ mA}$ ,  $V_{EN} = V_{IN}$ ,  $C_{IN} = 1\text{ }\mu\text{F}$ ,  $C_{OUT} = 4.7\text{ }\mu\text{F}$ , and  $C_{NR} = 0.01\text{ }\mu\text{F}$ ; all temperature values refer to  $T_J$ , unless otherwise noted.

**POWER-SUPPLY RIPPLE REJECTION vs FREQUENCY**

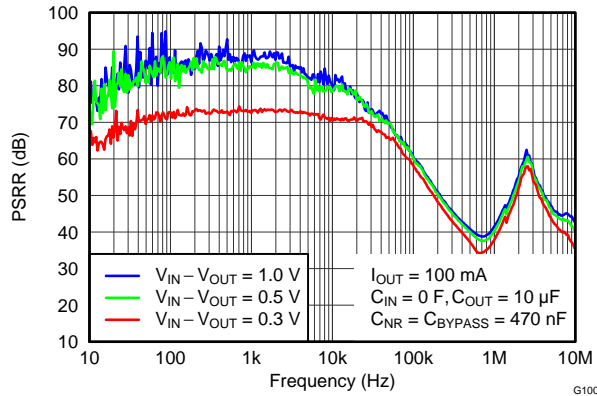

Figure 15.

**POWER-SUPPLY RIPPLE REJECTION vs FREQUENCY**

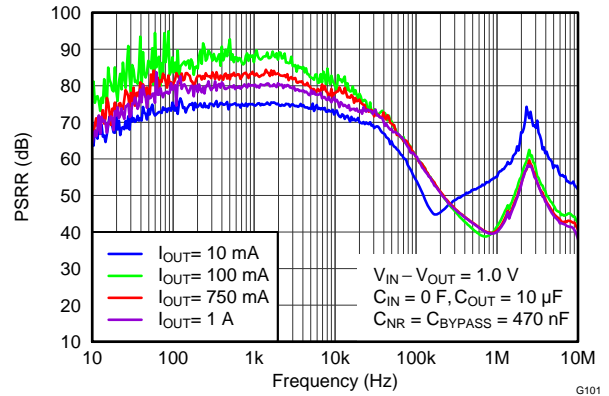

Figure 16.

**POWER-SUPPLY RIPPLE REJECTION vs FREQUENCY**

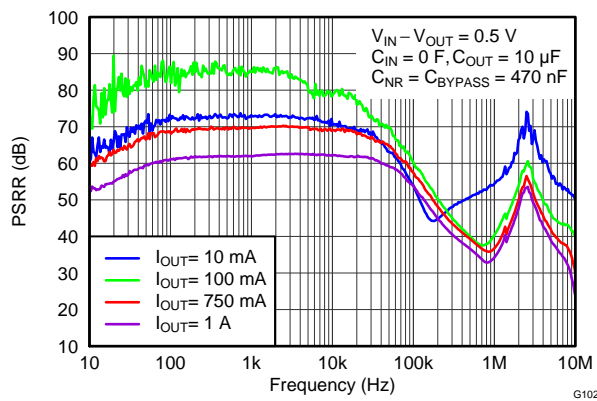

Figure 17.

**POWER-SUPPLY RIPPLE REJECTION vs FREQUENCY**

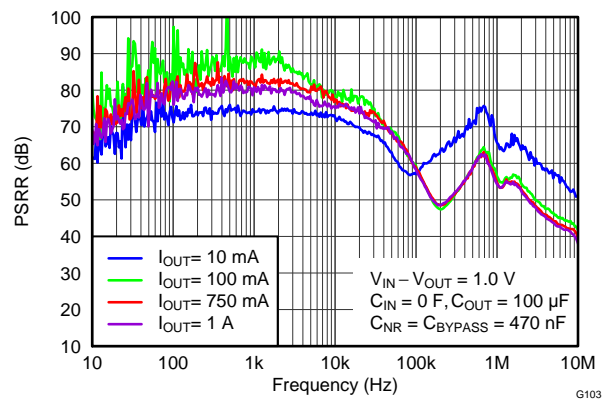

Figure 18.

**POWER-SUPPLY RIPPLE REJECTION vs FREQUENCY**

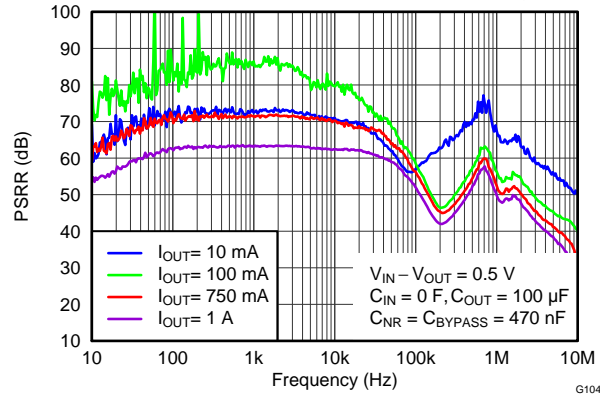

Figure 19.

**TYPICAL CHARACTERISTICS: TPS7A8101 (continued)**

At  $V_{OUT(TYP)} = 3.3\text{ V}$ ,  $V_{IN} = V_{OUT(TYP)} + 0.5\text{ V}$  or  $2.2\text{ V}$  (whichever is greater),  $I_{OUT} = 100\text{ mA}$ ,  $V_{EN} = V_{IN}$ ,  $C_{IN} = 1\text{ }\mu\text{F}$ ,  $C_{OUT} = 4.7\text{ }\mu\text{F}$ , and  $C_{NR} = 0.01\text{ }\mu\text{F}$ ; all temperature values refer to  $T_J$ , unless otherwise noted.

**POWER-SUPPLY RIPPLE REJECTION vs DROPOUT VOLTAGE**

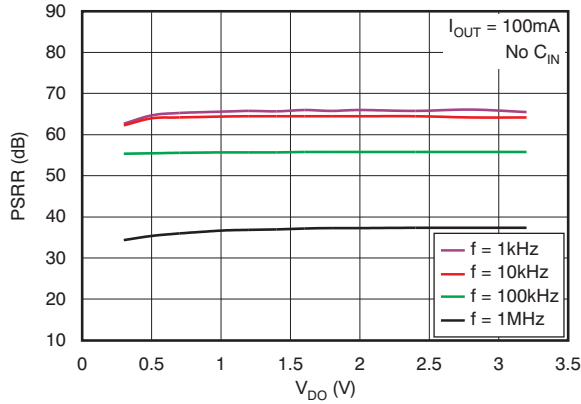

Figure 20.

**POWER-SUPPLY RIPPLE REJECTION vs DROPOUT VOLTAGE**

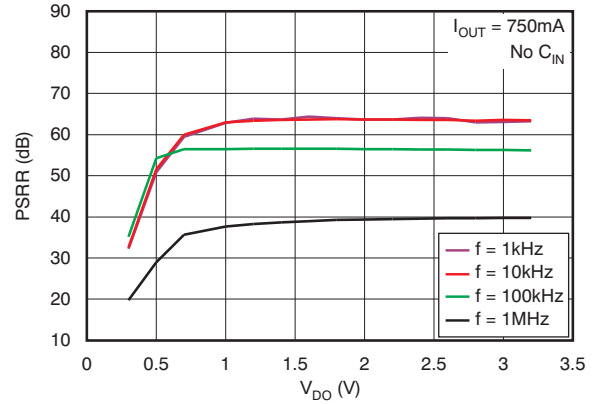

Figure 21.

**OUTPUT SPECTRAL NOISE DENSITY vs FREQUENCY**

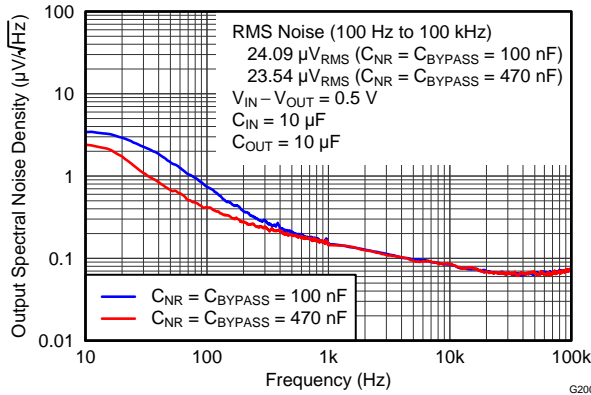

Figure 22.

**OUTPUT SPECTRAL NOISE DENSITY vs FREQUENCY**

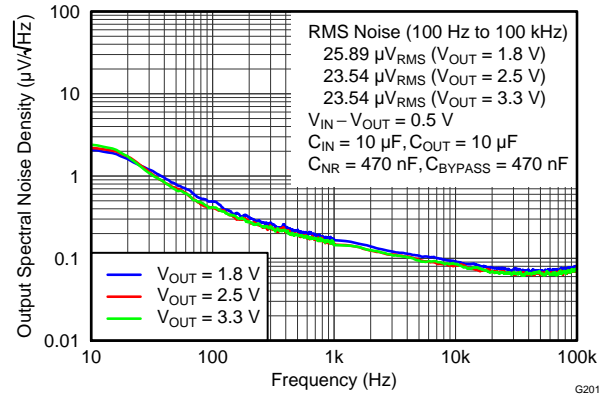

Figure 23.

**OUTPUT SPECTRAL NOISE DENSITY vs FREQUENCY**

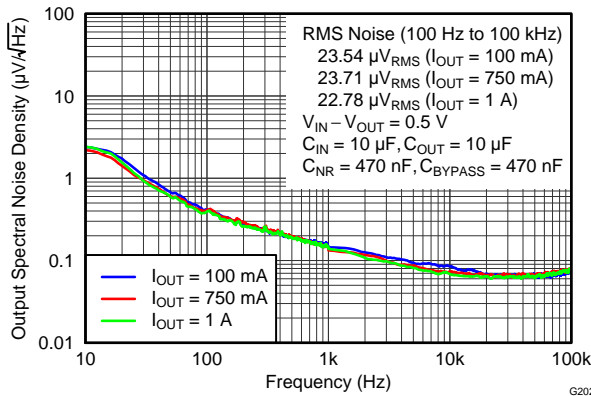

Figure 24.

**OUTPUT SPECTRAL NOISE DENSITY vs FREQUENCY**

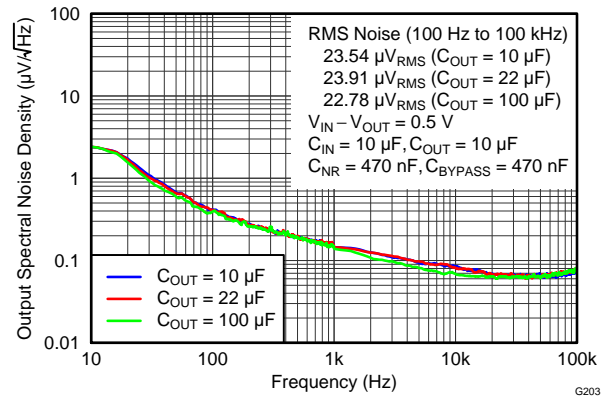

Figure 25.

**TYPICAL CHARACTERISTICS: TPS7A8101 (continued)**

At  $V_{OUT(TYP)} = 3.3\text{ V}$ ,  $V_{IN} = V_{OUT(TYP)} + 0.5\text{ V}$  or  $2.2\text{ V}$  (whichever is greater),  $I_{OUT} = 100\text{ mA}$ ,  $V_{EN} = V_{IN}$ ,  $C_{IN} = 1\text{ }\mu\text{F}$ ,  $C_{OUT} = 4.7\text{ }\mu\text{F}$ , and  $C_{NR} = 0.01\text{ }\mu\text{F}$ ; all temperature values refer to  $T_J$ , unless otherwise noted.

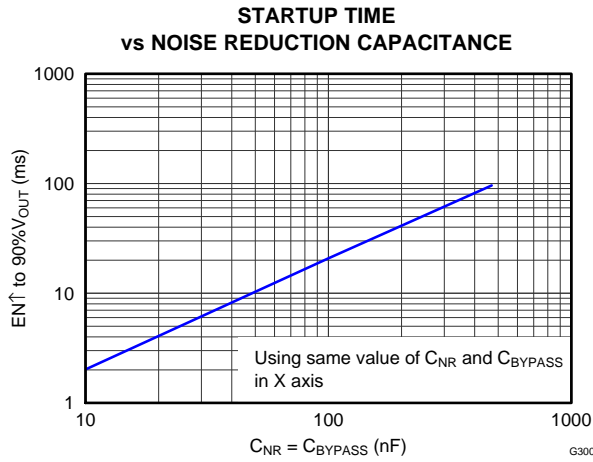

Figure 26.

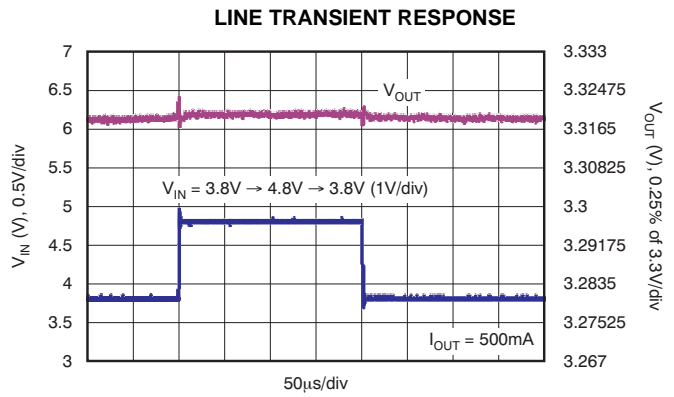

Figure 27.

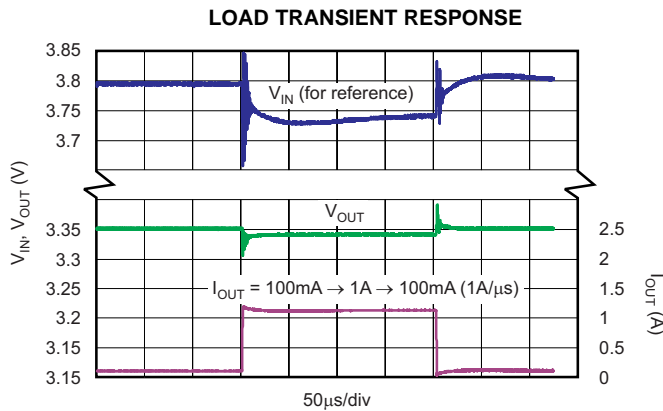

Figure 28.

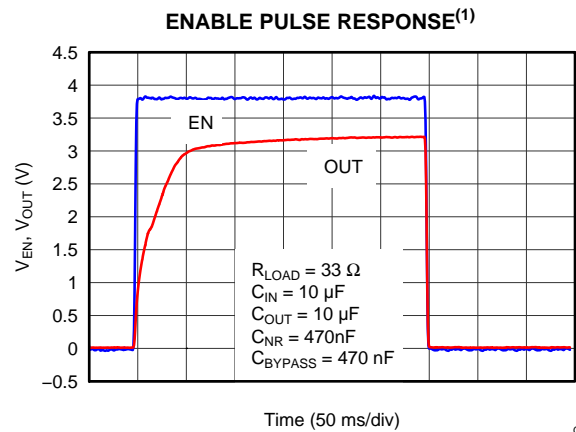

Figure 29.

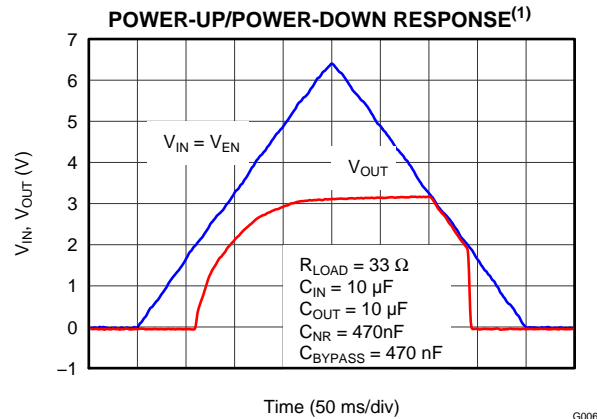

Figure 30.

(1) The internal reference requires approximately 80 ms of rampup time (see **STARTUP**) from the enable event; therefore,  $V_{OUT}$  fully reaches the target output voltage of 3.3 V in 80 ms from startup.

## APPLICATION INFORMATION

### OVERVIEW

The TPS7A8101 belongs to a family of new generation LDO regulators that use innovative circuitry to achieve wide bandwidth and high loop gain, resulting in extremely high PSRR (over a 1-MHz range) at very low headroom ( $V_{IN} - V_{OUT}$ ). A noise reduction capacitor ( $C_{NR}$ ) at the NR pin and a bypass capacitor ( $C_{BYPASS}$ ) bypass noise generated by the bandgap reference in order to improve PSRR, while a quick-start circuit fast-charges the noise reduction capacitor. This family of regulators offers sub-bandgap output voltages, current limit, and thermal protection, and is fully specified from  $-40^{\circ}\text{C}$  to  $+125^{\circ}\text{C}$ .

### Recommended Component Values

**Table 1. Recommended Capacitor Values**

SYMBOL	NAME	VALUE
$C_{IN}$	Input capacitor	10 $\mu\text{F}$
$C_{OUT}$	Output capacitor	10 $\mu\text{F}$
$C_{NR}$	Noise reduction capacitor between NR and GND	470 nF
$C_{BYPASS}$	Noise reduction capacitor across $R_1$	470 nF

**Table 2. Recommended Feedback Resistor Values for Common Output Voltages**

$V_{OUT}$	$R_1$	$R_2$
0.8 V	0 $\Omega$ (Short)	10.0 k $\Omega$
1.0 V	2.49 k $\Omega$	10.0 k $\Omega$
1.2 V	4.99 k $\Omega$	10.0 k $\Omega$
1.5 V	8.87 k $\Omega$	10.0 k $\Omega$
1.8 V	12.5 k $\Omega$	10.0 k $\Omega$
2.5 V	21.0 k $\Omega$	10.0 k $\Omega$
3.3 V	30.9 k $\Omega$	10.0 k $\Omega$
5.0 V	52.3 k $\Omega$	10.0 k $\Omega$

### TYPICAL APPLICATION CONFIGURATION

Figure 31 illustrates the connections for the device.

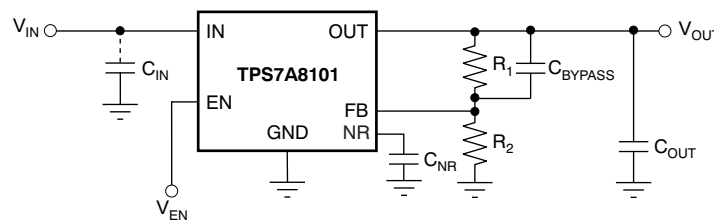

**Figure 31. Typical Application Circuit (Adjustable Voltage Version)**

The voltage on the FB pin sets the output voltage and is determined by the values of  $R_1$  and  $R_2$ . The values of  $R_1$  and  $R_2$  can be calculated for any voltage using the formula given in Equation 1:

$$V_{OUT} = \frac{(R_1 + R_2)}{R_2} \times 0.800 \quad (1)$$

Table 2 shows sample resistor values for common output voltages. In Table 2, E96 series resistors are used, and all values meet 1% of the target  $V_{OUT}$ , assuming resistors with zero error. For the actual design, pay attention to any resistor error factors. Using lower values for  $R_1$  and  $R_2$  reduces the noise injected from the FB pin.

## INPUT AND OUTPUT CAPACITOR REQUIREMENTS

Although an input capacitor is not required for stability, it is good analog design practice to connect a 0.1- $\mu\text{F}$  to 1.0- $\mu\text{F}$  low equivalent series resistance (ESR) capacitor across the input supply near the regulator. This capacitor counteracts reactive input sources and improves transient response, noise rejection, and ripple rejection. A higher-value capacitor may be necessary if large, fast rise-time load transients are anticipated or if the device is located several inches from the power source. If source impedance is not sufficiently low, a 0.1- $\mu\text{F}$  input capacitor may be necessary to ensure stability.

The TPS7A8101 is designed to be stable with standard ceramic capacitors of capacitance values 4.7  $\mu\text{F}$  or larger. This device is evaluated using a 10- $\mu\text{F}$  ceramic capacitor of 10-V rating, 10% tolerance, X5R type, and 0805 size (2.0 mm x 1.25 mm).

X5R- and X7R-type capacitors are highly recommended because they have minimal variation in value and ESR over temperature. Maximum ESR should be less than 1.0  $\Omega$ .

## OUTPUT NOISE

In most LDOs, the bandgap is the dominant noise source. If a noise reduction capacitor ( $C_{\text{NR}}$ ) is used with the TPS7A8101, the bandgap does not contribute significantly to noise. Instead, noise is dominated by the output resistor divider and the error amplifier input. If a bypass capacitor ( $C_{\text{BYPASS}}$ ) across the high-side feedback resistor ( $R_1$ ) is used with the TPS7A8101 in addition to  $C_{\text{NR}}$ , noise from these other sources can also be significantly reduced.

To maximize noise performance in a given application, use a 0.47- $\mu\text{F}$  noise-reduction capacitor plus a 0.47- $\mu\text{F}$  bypass capacitor.

## BOARD LAYOUT RECOMMENDATIONS TO IMPROVE PSRR AND NOISE PERFORMANCE

To improve ac performance such as PSRR, output noise, and transient response, it is recommended that the board be designed with separate ground planes for  $V_{\text{IN}}$  and  $V_{\text{OUT}}$ , with each ground plane connected only at the GND pin of the device. In addition, the ground connection for the bypass capacitor should connect directly to the GND pin of the device.

## INTERNAL CURRENT LIMIT

The TPS7A8101 internal current limit helps protect the regulator during fault conditions. During current limit, the output sources a fixed amount of current that is largely independent of output voltage. For reliable operation, the device should not be operated in a current limit state for extended periods of time.

The PMOS pass element in the TPS7A8101 has a built-in body diode that conducts current when the voltage at OUT exceeds the voltage at IN. This current is not limited, so if extended reverse voltage operation is anticipated, external limiting may be appropriate.

## SHUTDOWN

The enable pin (EN) is active high and is compatible with standard and low voltage, TTL-CMOS levels. When shutdown capability is not required, EN can be connected to IN.

## DROPOUT VOLTAGE

The TPS7A8101 uses a PMOS pass transistor to achieve low dropout. When ( $V_{\text{IN}} - V_{\text{OUT}}$ ) is less than the dropout voltage ( $V_{\text{DO}}$ ), the PMOS pass device is in its linear region of operation and the input-to-output resistance is the  $R_{\text{DS(ON)}}$  of the PMOS pass element.  $V_{\text{DO}}$  scales approximately with output current because the PMOS device in dropout behaves the same way as a resistor.

As with any linear regulator, PSRR and transient response are degraded as ( $V_{\text{IN}} - V_{\text{OUT}}$ ) approaches dropout. This effect is shown in [Figure 20](#) and [Figure 21](#) in the [Typical Characteristics](#) section.

## STARTUP

Through a lower resistance, the bandgap reference can quickly charge the noise reduction capacitor ( $C_{NR}$ ). The TPS7A8101 has a *quick-start* circuit to quickly charge  $C_{NR}$ , if present; see the [Functional Block Diagrams](#). At startup, this quick-start switch is closed, with only 33 k $\Omega$  of resistance between the bandgap reference and the NR pin. The quick-start switch opens approximately 100 ms after any device enabling event, and the resistance between the bandgap reference and the NR pin becomes higher in value (approximately 250 k $\Omega$ ) to form a very good low-pass (RC) filter. This low-pass filter achieves very good noise reduction for the reference voltage.

Inrush current can be a problem in many applications. The 33-k $\Omega$  resistance during the startup period is intentionally put there to slow down the reference voltage ramp up, thus reducing the inrush current. For example, the capacitance of connecting the recommended  $C_{NR}$  value of 0.47  $\mu$ F along with the 33-k $\Omega$  resistance causes approximately 80-ms RC delay. Startup time with the other  $C_{NR}$  values can be calculated as:

$$t_{STR} (s) = 170,000 \times C_{NR} (F) \quad (2)$$

Although the noise reduction effect is nearly saturated at 0.47  $\mu$ F, connecting a  $C_{NR}$  value greater than 0.47  $\mu$ F can help reduce noise slightly more; however, startup time will be extremely long because the quick-start switch opens after approximately 100 ms. That is, if  $C_{NR}$  is not fully charged during this 100-ms period,  $C_{NR}$  finishes charging through a higher resistance of 250 k $\Omega$ , and takes much longer to fully charge.

Note that a low leakage  $C_{NR}$  should be used; most ceramic capacitors are suitable.

## TRANSIENT RESPONSE

As with any regulator, increasing the size of the output capacitor reduces over/undershoot magnitude but increases duration of the transient response. Line transient performance can be improved by using a larger noise reduction capacitor ( $C_{NR}$ ) and/or bypass capacitor ( $C_{BYPASS}$ ).

## UNDERVOLTAGE LOCK-OUT (UVLO)

The TPS7A8101 uses an undervoltage lock-out circuit to keep the output shut off until the internal circuitry is operating properly. The UVLO circuit has a de-glitch feature so that it typically ignores undershoot transients on the input if they are less than 50- $\mu$ s duration.

## MINIMUM LOAD

The TPS7A8101 is stable and well-behaved with no output load. Traditional PMOS LDO regulators suffer from lower loop gain at very light output loads. The TPS7A8101 employs an innovative low-current mode circuit to increase loop gain under very light or no-load conditions, resulting in improved output voltage regulation performance down to zero output current.

## THERMAL INFORMATION

### Thermal Protection

Thermal protection disables the output when the junction temperature rises to approximately +160 $^{\circ}$ C, allowing the device to cool. When the junction temperature cools to approximately +140 $^{\circ}$ C the output circuitry is again enabled. Depending on power dissipation, thermal resistance, and ambient temperature, the thermal protection circuit may cycle on and off. This cycling limits the dissipation of the regulator, protecting it from damage because of overheating.

Any tendency to activate the thermal protection circuit indicates excessive power dissipation or an inadequate heatsink. For reliable operation, junction temperature should be limited to +125 $^{\circ}$ C maximum. To estimate the margin of safety in a complete design (including heatsink), increase the ambient temperature until the thermal protection is triggered; use worst-case loads and signal conditions. For good reliability, thermal protection should trigger at least +35 $^{\circ}$ C above the maximum expected ambient condition of your particular application. This configuration produces a worst-case junction temperature of +125 $^{\circ}$ C at the highest expected ambient temperature and worst-case load.

The internal protection circuitry of the TPS7A8101 has been designed to protect against overload conditions. It was not intended to replace proper heatsinking. Continuously running the TPS7A8101 into thermal shutdown degrades device reliability.

## Power Dissipation

Knowing the device power dissipation and proper sizing of the thermal plane that is connected to the tab or pad is critical to avoiding thermal shutdown and ensuring reliable operation.

Power dissipation of the device depends on input voltage and load conditions and can be calculated using [Equation 3](#):

$$P_D = (V_{IN} - V_{OUT}) \times I_{OUT} \quad (3)$$

Power dissipation can be minimized and greater efficiency can be achieved by using the lowest possible input voltage necessary to achieve the required output voltage regulation.

On the SON (DRB) package, the primary conduction path for heat is through the exposed pad to the printed circuit board (PCB). The pad can be connected to ground or be left floating; however, it should be attached to an appropriate amount of copper PCB area to ensure the device does not overheat. The maximum junction-to-ambient thermal resistance depends on the maximum ambient temperature, maximum device junction temperature, and power dissipation of the device and can be calculated using [Equation 4](#):

$$R_{\theta JA} = \frac{(+125^{\circ}\text{C} - T_A)}{P_D} \quad (4)$$

Knowing the maximum  $R_{\theta JA}$ , the minimum amount of PCB copper area needed for appropriate heatsinking can be estimated using [Figure 32](#).

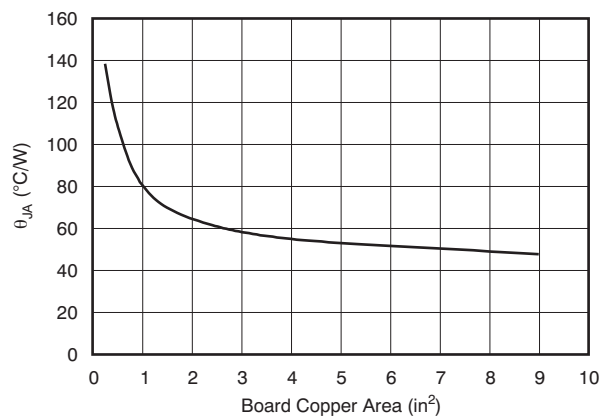

Note:  $\theta_{JA}$  value at board size of 9 in<sup>2</sup> (that is, 3 in × 3 in) is a JEDEC standard.

**Figure 32.  $\theta_{JA}$  vs Board Size**

[Figure 32](#) shows the variation of  $\theta_{JA}$  as a function of ground plane copper area in the board. It is intended only as a guideline to demonstrate the effects of heat spreading in the ground plane and should not be used to estimate actual thermal performance in real application environments.

**NOTE:** When the device is mounted on an application PCB, it is strongly recommended to use  $\Psi_{JT}$  and  $\Psi_{JB}$ , as explained in the [Estimating Junction Temperature](#) section.



### Estimating Junction Temperature

Using the thermal metrics  $\Psi_{JT}$  and  $\Psi_{JB}$ , as shown in the *Thermal Information* table, the junction temperature can be estimated with corresponding formulas (given in Equation 5). For backwards compatibility, an older  $\theta_{JC,Top}$  parameter is listed as well.

$$\Psi_{JT}: T_J = T_T + \Psi_{JT} \cdot P_D$$

$$\Psi_{JB}: T_J = T_B + \Psi_{JB} \cdot P_D \tag{5}$$

Where  $P_D$  is the power dissipation shown by Equation 4,  $T_T$  is the temperature at the center-top of the IC package, and  $T_B$  is the PCB temperature measured 1 mm away from the IC package on the PCB surface (as Figure 33 shows).

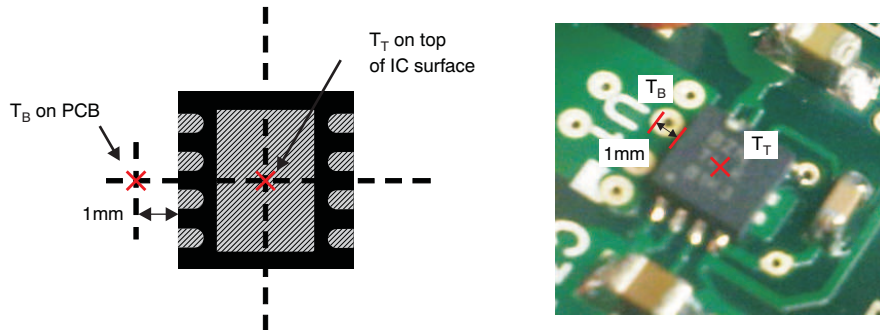

Figure 33. Measuring Points for  $T_T$  and  $T_B$

**NOTE:** Both  $T_T$  and  $T_B$  can be measured on actual application boards using an infrared thermometer.

For more information about measuring  $T_T$  and  $T_B$ , see the application note [SBVA025, Using New Thermal Metrics](#), available for download at [www.ti.com](#).

By looking at Figure 34, the new thermal metrics ( $\Psi_{JT}$  and  $\Psi_{JB}$ ) have very little dependency on board size. That is, using  $\Psi_{JT}$  or  $\Psi_{JB}$  with Equation 5 is a good way to estimate  $T_J$  by simply measuring  $T_T$  or  $T_B$ , regardless of the application board size.

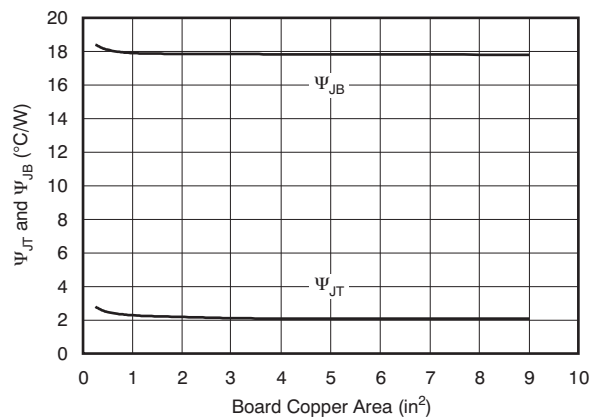

Figure 34.  $\Psi_{JT}$  and  $\Psi_{JB}$  vs Board Size

For a more detailed discussion of why TI does not recommend using  $\theta_{JC(top)}$  to determine thermal characteristics, refer to application report [SBVA025, Using New Thermal Metrics](#), available for download at [www.ti.com](#). For further information, refer to application report [SPRA953, IC Package Thermal Metrics](#), also available on the TI website.



**REVISION HISTORY**

NOTE: Page numbers for previous revisions may differ from page numbers in the current version.

<b>Changes from Original (December 2011) to Revision A</b>	<b>Page</b>
• Added new footnote 2 to Thermal Information table, changed footnote 3 .....	<b>3</b>

**PACKAGING INFORMATION**

Orderable Device	Status <sup>(1)</sup>	Package Type	Package Drawing	Pins	Package Qty	Eco Plan <sup>(2)</sup>	Lead/ Ball Finish	MSL Peak Temp <sup>(3)</sup>	Samples (Requires Login)
TPS7A8101DRBR	ACTIVE	SON	DRB	8	3000	Green (RoHS & no Sb/Br)	CU NIPDAU	Level-2-260C-1 YEAR	
TPS7A8101DRBT	ACTIVE	SON	DRB	8	250	Green (RoHS & no Sb/Br)	CU NIPDAU	Level-2-260C-1 YEAR	

<sup>(1)</sup> The marketing status values are defined as follows:

**ACTIVE:** Product device recommended for new designs.

**LIFEBUY:** TI has announced that the device will be discontinued, and a lifetime-buy period is in effect.

**NRND:** Not recommended for new designs. Device is in production to support existing customers, but TI does not recommend using this part in a new design.

**PREVIEW:** Device has been announced but is not in production. Samples may or may not be available.

**OBsolete:** TI has discontinued the production of the device.

<sup>(2)</sup> Eco Plan - The planned eco-friendly classification: Pb-Free (RoHS), Pb-Free (RoHS Exempt), or Green (RoHS & no Sb/Br) - please check <http://www.ti.com/productcontent> for the latest availability information and additional product content details.

**TBD:** The Pb-Free/Green conversion plan has not been defined.

**Pb-Free (RoHS):** TI's terms "Lead-Free" or "Pb-Free" mean semiconductor products that are compatible with the current RoHS requirements for all 6 substances, including the requirement that lead not exceed 0.1% by weight in homogeneous materials. Where designed to be soldered at high temperatures, TI Pb-Free products are suitable for use in specified lead-free processes.

**Pb-Free (RoHS Exempt):** This component has a RoHS exemption for either 1) lead-based flip-chip solder bumps used between the die and package, or 2) lead-based die adhesive used between the die and leadframe. The component is otherwise considered Pb-Free (RoHS compatible) as defined above.

**Green (RoHS & no Sb/Br):** TI defines "Green" to mean Pb-Free (RoHS compatible), and free of Bromine (Br) and Antimony (Sb) based flame retardants (Br or Sb do not exceed 0.1% by weight in homogeneous material)

<sup>(3)</sup> MSL, Peak Temp. -- The Moisture Sensitivity Level rating according to the JEDEC industry standard classifications, and peak solder temperature.

**Important Information and Disclaimer:** The information provided on this page represents TI's knowledge and belief as of the date that it is provided. TI bases its knowledge and belief on information provided by third parties, and makes no representation or warranty as to the accuracy of such information. Efforts are underway to better integrate information from third parties. TI has taken and continues to take reasonable steps to provide representative and accurate information but may not have conducted destructive testing or chemical analysis on incoming materials and chemicals. TI and TI suppliers consider certain information to be proprietary, and thus CAS numbers and other limited information may not be available for release.

In no event shall TI's liability arising out of such information exceed the total purchase price of the TI part(s) at issue in this document sold by TI to Customer on an annual basis.

**TAPE AND REEL INFORMATION**
**REEL DIMENSIONS**

**TAPE DIMENSIONS**

A0	Dimension designed to accommodate the component width
B0	Dimension designed to accommodate the component length
K0	Dimension designed to accommodate the component thickness
W	Overall width of the carrier tape
P1	Pitch between successive cavity centers

**TAPE AND REEL INFORMATION**

\*All dimensions are nominal

Device	Package Type	Package Drawing	Pins	SPQ	Reel Diameter (mm)	Reel Width W1 (mm)	A0 (mm)	B0 (mm)	K0 (mm)	P1 (mm)	W (mm)	Pin1 Quadrant
TPS7A8101DRBR	SON	DRB	8	3000	330.0	12.4	3.3	3.3	1.1	8.0	12.0	Q2
TPS7A8101DRBT	SON	DRB	8	250	180.0	12.4	3.3	3.3	1.1	8.0	12.0	Q2

**TAPE AND REEL BOX DIMENSIONS**

\*All dimensions are nominal

Device	Package Type	Package Drawing	Pins	SPQ	Length (mm)	Width (mm)	Height (mm)
TPS7A8101DRBR	SON	DRB	8	3000	367.0	367.0	35.0
TPS7A8101DRBT	SON	DRB	8	250	210.0	185.0	35.0

DRB (S-PVSON-N8)

PLASTIC SMALL OUTLINE NO-LEAD



- NOTES:
- All linear dimensions are in millimeters. Dimensioning and tolerancing per ASME Y14.5M-1994.
  - This drawing is subject to change without notice.
  - Small Outline No-Lead (SON) package configuration.
  - The package thermal pad must be soldered to the board for thermal and mechanical performance.
  - See the additional figure in the Product Data Sheet for details regarding the exposed thermal pad features and dimensions.

# THERMAL PAD MECHANICAL DATA

DRB (S-PVSON-N8)

PLASTIC SMALL OUTLINE NO-LEAD

## THERMAL INFORMATION

This package incorporates an exposed thermal pad that is designed to be attached directly to an external heatsink. The thermal pad must be soldered directly to the printed circuit board (PCB). After soldering, the PCB can be used as a heatsink. In addition, through the use of thermal vias, the thermal pad can be attached directly to the appropriate copper plane shown in the electrical schematic for the device, or alternatively, can be attached to a special heatsink structure designed into the PCB. This design optimizes the heat transfer from the integrated circuit (IC).

For information on the Quad Flatpack No-Lead (QFN) package and its advantages, refer to Application Report, QFN/SON PCB Attachment, Texas Instruments Literature No. SLUA271. This document is available at [www.ti.com](http://www.ti.com).

The exposed thermal pad dimensions for this package are shown in the following illustration.

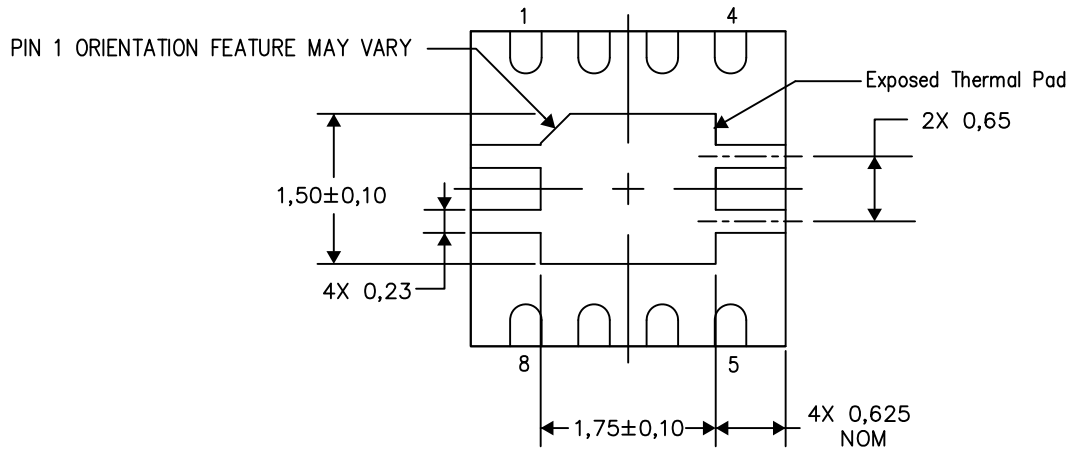

Bottom View

Exposed Thermal Pad Dimensions

4206340-2/M 06/12

NOTE: All linear dimensions are in millimeters

DRB (S-PVSON-N8)

PLASTIC SMALL OUTLINE NO-LEAD

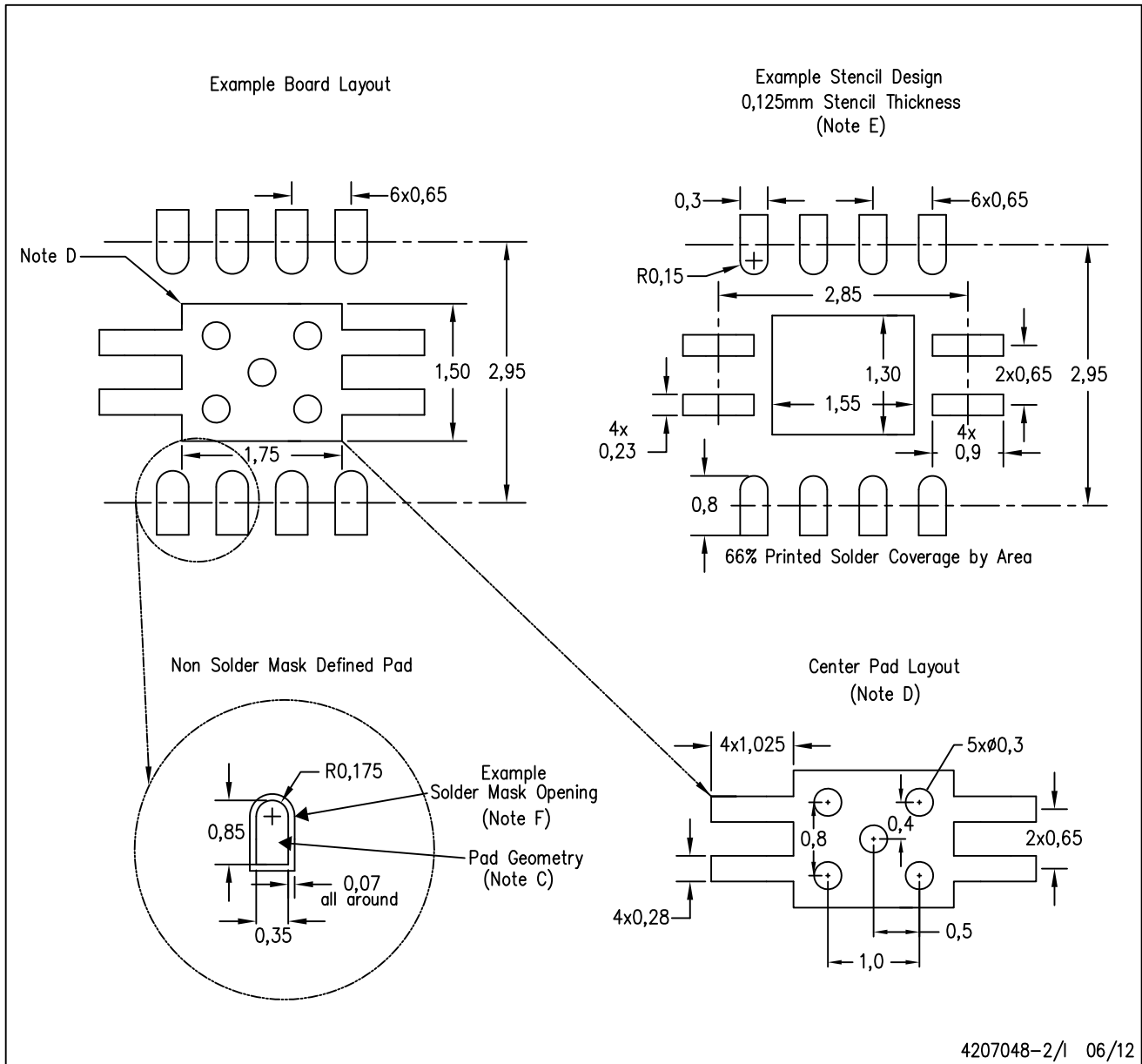

- NOTES:
- All linear dimensions are in millimeters.
  - This drawing is subject to change without notice.
  - Publication IPC-7351 is recommended for alternate designs.
  - This package is designed to be soldered to a thermal pad on the board. Refer to Application Note, QFN Packages, Texas Instruments Literature No. SLUA271, and also the Product Data Sheets for specific thermal information, via requirements, and recommended board layout. These documents are available at [www.ti.com](http://www.ti.com) <<http://www.ti.com>>.
  - Laser cutting apertures with trapezoidal walls and also rounding corners will offer better paste release. Customers should contact their board assembly site for stencil design recommendations. Refer to IPC 7525 for stencil design considerations.
  - Customers should contact their board fabrication site for solder mask tolerances.

## IMPORTANT NOTICE

Texas Instruments Incorporated and its subsidiaries (TI) reserve the right to make corrections, enhancements, improvements and other changes to its semiconductor products and services per JESD46C and to discontinue any product or service per JESD48B. Buyers should obtain the latest relevant information before placing orders and should verify that such information is current and complete. All semiconductor products (also referred to herein as "components") are sold subject to TI's terms and conditions of sale supplied at the time of order acknowledgment.

TI warrants performance of its components to the specifications applicable at the time of sale, in accordance with the warranty in TI's terms and conditions of sale of semiconductor products. Testing and other quality control techniques are used to the extent TI deems necessary to support this warranty. Except where mandated by applicable law, testing of all parameters of each component is not necessarily performed.

TI assumes no liability for applications assistance or the design of Buyers' products. Buyers are responsible for their products and applications using TI components. To minimize the risks associated with Buyers' products and applications, Buyers should provide adequate design and operating safeguards.

TI does not warrant or represent that any license, either express or implied, is granted under any patent right, copyright, mask work right, or other intellectual property right relating to any combination, machine, or process in which TI components or services are used. Information published by TI regarding third-party products or services does not constitute a license to use such products or services or a warranty or endorsement thereof. Use of such information may require a license from a third party under the patents or other intellectual property of the third party, or a license from TI under the patents or other intellectual property of TI.

Reproduction of significant portions of TI information in TI data books or data sheets is permissible only if reproduction is without alteration and is accompanied by all associated warranties, conditions, limitations, and notices. TI is not responsible or liable for such altered documentation. Information of third parties may be subject to additional restrictions.

Resale of TI components or services with statements different from or beyond the parameters stated by TI for that component or service voids all express and any implied warranties for the associated TI component or service and is an unfair and deceptive business practice. TI is not responsible or liable for any such statements.

Buyer acknowledges and agrees that it is solely responsible for compliance with all legal, regulatory and safety-related requirements concerning its products, and any use of TI components in its applications, notwithstanding any applications-related information or support that may be provided by TI. Buyer represents and agrees that it has all the necessary expertise to create and implement safeguards which anticipate dangerous consequences of failures, monitor failures and their consequences, lessen the likelihood of failures that might cause harm and take appropriate remedial actions. Buyer will fully indemnify TI and its representatives against any damages arising out of the use of any TI components in safety-critical applications.

In some cases, TI components may be promoted specifically to facilitate safety-related applications. With such components, TI's goal is to help enable customers to design and create their own end-product solutions that meet applicable functional safety standards and requirements. Nonetheless, such components are subject to these terms.

No TI components are authorized for use in FDA Class III (or similar life-critical medical equipment) unless authorized officers of the parties have executed a special agreement specifically governing such use.

Only those TI components which TI has specifically designated as military grade or "enhanced plastic" are designed and intended for use in military/aerospace applications or environments. Buyer acknowledges and agrees that any military or aerospace use of TI components which have **not** been so designated is solely at the Buyer's risk, and that Buyer is solely responsible for compliance with all legal and regulatory requirements in connection with such use.

TI has specifically designated certain components which meet ISO/TS16949 requirements, mainly for automotive use. Components which have not been so designated are neither designed nor intended for automotive use; and TI will not be responsible for any failure of such components to meet such requirements.

### Products

Audio	<a href="http://www.ti.com/audio">www.ti.com/audio</a>
Amplifiers	<a href="http://amplifier.ti.com">amplifier.ti.com</a>
Data Converters	<a href="http://dataconverter.ti.com">dataconverter.ti.com</a>
DLP® Products	<a href="http://www.dlp.com">www.dlp.com</a>
DSP	<a href="http://dsp.ti.com">dsp.ti.com</a>
Clocks and Timers	<a href="http://www.ti.com/clocks">www.ti.com/clocks</a>
Interface	<a href="http://interface.ti.com">interface.ti.com</a>
Logic	<a href="http://logic.ti.com">logic.ti.com</a>
Power Mgmt	<a href="http://power.ti.com">power.ti.com</a>
Microcontrollers	<a href="http://microcontroller.ti.com">microcontroller.ti.com</a>
RFID	<a href="http://www.ti-rfid.com">www.ti-rfid.com</a>
OMAP Mobile Processors	<a href="http://www.ti.com/omap">www.ti.com/omap</a>
Wireless Connectivity	<a href="http://www.ti.com/wirelessconnectivity">www.ti.com/wirelessconnectivity</a>

### Applications

Automotive and Transportation	<a href="http://www.ti.com/automotive">www.ti.com/automotive</a>
Communications and Telecom	<a href="http://www.ti.com/communications">www.ti.com/communications</a>
Computers and Peripherals	<a href="http://www.ti.com/computers">www.ti.com/computers</a>
Consumer Electronics	<a href="http://www.ti.com/consumer-apps">www.ti.com/consumer-apps</a>
Energy and Lighting	<a href="http://www.ti.com/energy">www.ti.com/energy</a>
Industrial	<a href="http://www.ti.com/industrial">www.ti.com/industrial</a>
Medical	<a href="http://www.ti.com/medical">www.ti.com/medical</a>
Security	<a href="http://www.ti.com/security">www.ti.com/security</a>
Space, Avionics and Defense	<a href="http://www.ti.com/space-avionics-defense">www.ti.com/space-avionics-defense</a>
Video and Imaging	<a href="http://www.ti.com/video">www.ti.com/video</a>

**TI E2E Community** [e2e.ti.com](http://e2e.ti.com)