

200mA, Low Quiescent Current, Ultra-Low Noise, High PSRR Low Dropout Linear Regulator

FEATURES

- 200mA Low Dropout Regulator with EN
- Low I_Q : 40 μ A
- Available in Multiple Output Voltage Versions:
 - Fixed Outputs of 1.2V, 1.5V, 1.6V, 1.8V, 1.9V, 2.5V, 2.7V, 2.8V, 2.85V, 2.9V, 3.0V, 3.2V, and 3.3V
 - Adjustable Outputs from 1.2V to 6.5V
 - Additional Outputs Available Using Innovative Factory EEPROM Programming
- High PSRR: 66dB at 1kHz
- Ultra-low Noise: 29.5 μ V_{RMS}
- Fast Start-Up Time: 45 μ s
- Stable with a Low-ESR, 2.0 μ F Typical Output Capacitance
- Excellent Load/Line Transient Response
- 2% Overall Accuracy (Load/Line/Temp)
- Very Low Dropout: 100mV
- ThinSOT-23, WCSP, and 2mm x 2mm SON-6 Packages

APPLICATIONS

- Cellular Phones
- Wireless LAN, Bluetooth™
- VCOs, RF
- Handheld Organizers, PDAs

DESCRIPTION

The TPS799xx family of low-dropout (LDO) low-power linear regulators offer excellent AC performance with very low ground current. High power-supply rejection ratio (PSRR), low noise, fast start-up, and excellent line and load transient response are provided while consuming a very low 40 μ A (typical) ground current. The TPS799xx is stable with ceramic capacitors and uses an advanced BiCMOS fabrication process to yield dropout voltage typically 110mV at 200mA output. The TPS799xx uses a precision voltage reference and feedback loop to achieve overall accuracy of 2% over all load, line, process, and temperature variations. It is fully specified from $T_J = -40^{\circ}\text{C}$ to $+125^{\circ}\text{C}$ and is offered in low profile ThinSOT23, Wafer Chip-Scale (WCSP), and 2mm x 2mm SON packages, ideal for wireless handsets and WLAN cards.

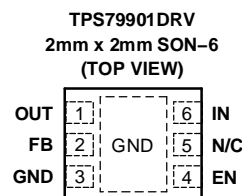
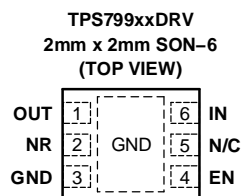
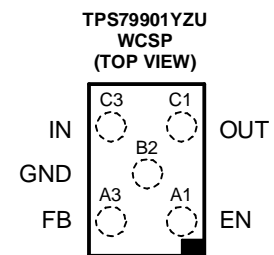
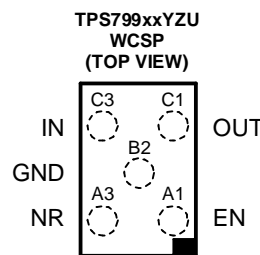
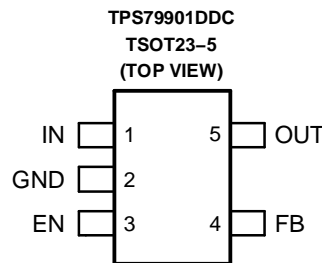
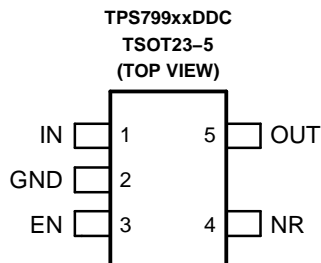

Please be aware that an important notice concerning availability, standard warranty, and use in critical applications of Texas Instruments semiconductor products and disclaimers thereto appears at the end of this data sheet.

Bluetooth is a trademark of Bluetooth SIG, Inc.
All trademarks are the property of their respective owners.



This integrated circuit can be damaged by ESD. Texas Instruments recommends that all integrated circuits be handled with appropriate precautions. Failure to observe proper handling and installation procedures can cause damage.

ESD damage can range from subtle performance degradation to complete device failure. Precision integrated circuits may be more susceptible to damage because very small parametric changes could cause the device not to meet its published specifications.

ORDERING INFORMATION⁽¹⁾

| PRODUCT | V _{OUT} ⁽²⁾ |
|--------------|--|
| TPS799xxyyyz | XX is nominal output voltage (for example, 28 = 2.8V, 285 = 2.85V, 01 = Adjustable). ⁽³⁾ YYY is package designator. Z is package quantity. |

- (1) For the most current package and ordering information, see the Package Option Addendum at the end of this document, or see the TI website at www.ti.com.
- (2) Output voltages from 1.2V to 4.5V in 50mV increments are available through the use of innovative factory EEPROM programming; minimum order quantities may apply. Contact factory for details and availability.
- (3) For fixed 1.2V operation, tie FB to OUT.

ABSOLUTE MAXIMUM RATINGS

Over operating temperature range (unless otherwise noted)⁽¹⁾

| PARAMETER | TPS799xx | UNIT |
|--|-------------------------------|------|
| V _{IN} range | –0.3 to +7.0 | V |
| V _{EN} range | –0.3 to V _{IN} +0.3 | V |
| V _{OUT} range | –0.3 to V _{IN} +0.3 | V |
| Peak output current | Internally limited | |
| Continuous total power dissipation | See Dissipation Ratings Table | |
| Junction temperature range, T _J | –55 to +150 | °C |
| Storage junction temperature range, T _{STG} | –55 to +150 | °C |
| ESD rating, HBM | 2 | kV |
| ESD rating, CDM | 500 | V |

- (1) Stresses above these ratings may cause permanent damage. Exposure to absolute maximum conditions for extended periods may degrade device reliability. These are stress ratings only, and functional operation of the device at these or any other conditions beyond those specified is not implied.

DISSIPATION RATINGS

| BOARD | PACKAGE | R _{θJC} | R _{θJA} | DERATING FACTOR ABOVE T _A = 25°C | T _A < 25°C | T _A = 70°C | T _A = 85°C |
|-----------------------|---------|------------------|------------------|--|-----------------------|-----------------------|-----------------------|
| Low-K ⁽¹⁾ | DDC | 90°C/W | 280°C/W | 3.6mW/°C | 360mW | 200mW | 145mW |
| High-K ⁽²⁾ | DDC | 90°C/W | 200°C/W | 5.0mW/°C | 500mW | 275mW | 200mW |
| Low-K ⁽¹⁾ | YZU | 27°C/W | 255°C/W | 3.9mW/°C | 390mW | 215mW | 155mW |
| High-K ⁽²⁾ | YZU | 27°C/W | 190°C/W | 5.3mW/°C | 530mW | 295mW | 215mW |
| Low-K ⁽¹⁾ | DRV | 20°C/W | 140°C/W | 7.1mW/°C | 715mW | 395mW | 285mW |
| High-K ⁽²⁾ | DRV | 20°C/W | 65°C/W | 15.4mW/°C | 1540mW | 845mW | 615mW |

- (1) The JEDEC low-K (1s) board used to derive this data was a 3in x 3in, two-layer board with 2-ounce copper traces on top of the board.
- (2) The JEDEC high-K (2s2p) board used to derive this data was a 3in x 3in, multilayer board with 1-ounce internal power and ground planes and 2-ounce copper traces on top and bottom of the board.

ELECTRICAL CHARACTERISTICS

Over operating temperature range ($T_J = -40^\circ\text{C}$ to $+125^\circ\text{C}$), $V_{IN} = V_{OUT(TYP)} + 0.3\text{V}$ or 2.7V , whichever is greater; $I_{OUT} = 1\text{mA}$, $V_{EN} = V_{IN}$, $C_{OUT} = 2.2\mu\text{F}$, $C_{NR} = 0.01\mu\text{F}$, unless otherwise noted. For TPS79901, $V_{OUT} = 3.0\text{V}$. Typical values are at $T_J = +25^\circ\text{C}$.

| PARAMETER | | TEST CONDITIONS | MIN | TYP | MAX | UNIT |
|-------------------------------------|---|--|----------|-----------|----------------|---------------------|
| V_{IN} | Input voltage range ⁽¹⁾ | | 2.7 | | 6.5 | V |
| V_{FB} | Internal reference (TPS79901) | | 1.169 | 1.193 | 1.217 | V |
| V_{OUT} | Output voltage range (TPS79901) | | V_{FB} | | $6.5 - V_{DO}$ | V |
| V_{OUT} | Output accuracy | Nominal $T_J = +25^\circ\text{C}$ | -1.0 | | +1.0 | % |
| V_{OUT} | Output accuracy ⁽¹⁾ | Over V_{IN} , I_{OUT} , Temp $V_{OUT} + 0.3\text{V} \leq V_{IN} \leq 6.5\text{V}$ $500\mu\text{A} \leq I_{OUT} \leq 200\text{mA}$ | -2.0 | ± 1.0 | +2.0 | % |
| $\Delta V_{OUT}\% / \Delta V_{IN}$ | Line regulation ⁽¹⁾ | $V_{OUT(NOM)} + 0.3\text{V} \leq V_{IN} \leq 6.5\text{V}$ | | 0.02 | | %/V |
| $\Delta V_{OUT}\% / \Delta I_{OUT}$ | Load regulation | $500\mu\text{A} \leq I_{OUT} \leq 200\text{mA}$ | | 0.002 | | %/mA |
| V_{DO} | Dropout voltage ⁽²⁾ ($V_{IN} = V_{OUT(NOM)} - 0.1\text{V}$) | $V_{OUT} < 3.3\text{V}$ $I_{OUT} = 200\text{mA}$ | | 100 | 175 | mV |
| V_{DO} | Dropout voltage ($V_{IN} = V_{OUT(NOM)} - 0.1\text{V}$) | $V_{OUT} \geq 3.3\text{V}$ $I_{OUT} = 200\text{mA}$ | | 90 | 160 | mV |
| I_{CL} | Output current limit | $V_{OUT} = 0.9 \times V_{OUT(NOM)}$ | 200 | 400 | 600 | mA |
| I_{GND} | Ground pin current | $500\mu\text{A} \leq I_{OUT} \leq 200\text{mA}$ | | 40 | 60 | μA |
| I_{SHDN} | Shutdown current (I_{GND}) | $V_{EN} \leq 0.4\text{V}$, $2.7\text{V} \leq V_{IN} \leq 6.5\text{V}$ | | 0.15 | 1.0 | μA |
| I_{FB} | Feedback pin current (TPS79901) | | -0.5 | | 0.5 | μA |
| PSRR | Power-supply rejection ratio $V_{IN} = 3.85\text{V}$, $V_{OUT} = 2.85\text{V}$, $C_{NR} = 0.01\mu\text{F}$, $I_{OUT} = 100\text{mA}$ | $f = 100\text{Hz}$ | | 70 | | dB |
| | | $f = 1\text{kHz}$ | | 66 | | dB |
| | | $f = 10\text{kHz}$ | | 51 | | dB |
| | | $f = 100\text{kHz}$ | | 38 | | dB |
| V_N | Output noise voltage BW = 10Hz to 100kHz, $V_{OUT} = 2.8\text{V}$ | $C_{NR} = 0.01\mu\text{F}$ | | 29.5 | | μV_{RMS} |
| | | $C_{NR} = \text{none}$ | | 263 | | μV_{RMS} |
| T_{STR} | Startup time $V_{OUT} = 2.85\text{V}$, $R_L = 14\Omega$, $C_{OUT} = 2.2\mu\text{F}$ | $C_{NR} = 0.001\mu\text{F}$ | | 45 | | μs |
| | | $C_{NR} = 0.047\mu\text{F}$ | | 45 | | μs |
| | | $C_{NR} = 0.01\mu\text{F}$ | | 50 | | μs |
| | | $C_{NR} = \text{none}$ | | 50 | | μs |
| $V_{EN(HI)}$ | Enable high (enabled) | | 1.2 | | V_{IN} | V |
| $V_{EN(LO)}$ | Enable low (shutdown) | | 0 | | 0.4 | V |
| $I_{EN(HI)}$ | Enable pin current, enabled | $V_{EN} = V_{IN} = 6.5\text{V}$ | | 0.03 | 1.0 | μA |
| TSD | Thermal shutdown temperature | Shutdown, temperature increasing | | 165 | | $^\circ\text{C}$ |
| | | Reset, temperature decreasing | | 145 | | $^\circ\text{C}$ |
| T_J | Operating junction temperature | | -40 | | +125 | $^\circ\text{C}$ |
| UVLO | Under voltage lockout | V_{IN} rising | 1.90 | 2.20 | 2.50 | V |
| | Hysteresis | V_{IN} falling | | 70 | | mV |

(1) Minimum $V_{IN} = V_{OUT} + V_{DO}$ or 2.7V , whichever is greater.

(2) V_{DO} is not measured for devices with $V_{OUT(NOM)} < 2.8\text{V}$ because minimum $V_{IN} = 2.7\text{V}$.

DEVICE INFORMATION

FUNCTIONAL BLOCK DIAGRAMS

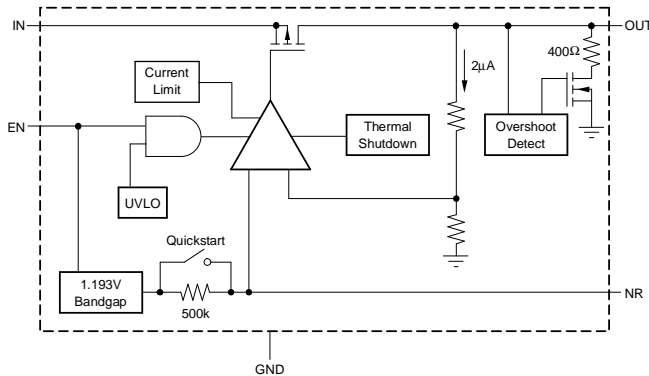

Figure 1. Fixed Voltage Versions

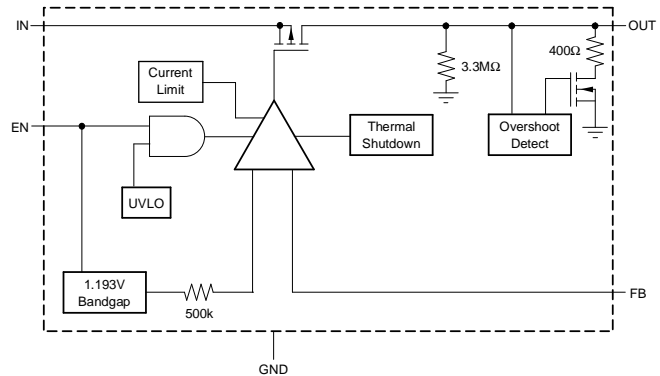

Figure 2. Adjustable Voltage Versions

PIN CONFIGURATIONS

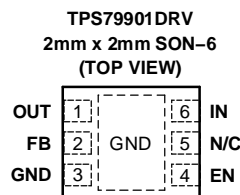
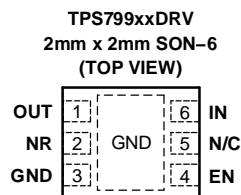
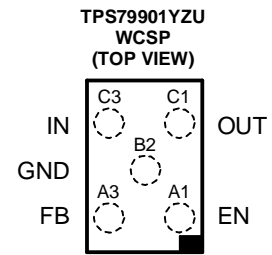
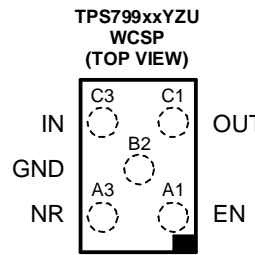
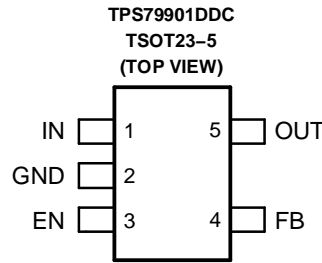
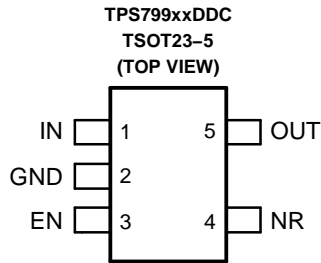

Table 1. PIN DESCRIPTIONS

| TPS799xx | | | | DESCRIPTION |
|----------|-----|-----|--------|--|
| NAME | DDC | YZU | DRV | |
| IN | 1 | C3 | 6 | Input supply. |
| GND | 2 | B2 | 3, Pad | Ground. The pad must be tied to GND. |
| EN | 3 | A1 | 4 | Driving the enable pin (EN) high turns on the regulator. Driving this pin low puts the regulator into shutdown mode. EN can be connected to IN if not used. |
| NR | 4 | A3 | 2 | Fixed voltage versions only; connecting an external capacitor to this pin bypasses noise generated by the internal bandgap. This allows output noise to be reduced to very low levels. |
| FB | 4 | A3 | 2 | Adjustable version only; this is the input to the control loop error amplifier, and is used to set the output voltage of the device. |
| OUT | 5 | C1 | 1 | Output of the regulator. A small capacitor (total typical capacitance $\geq 2.0\mu\text{F}$ ceramic) is needed from this pin to ground to assure stability. |
| N/C | — | — | 5 | Not internally connected. This pin must either be left open, or tied to GND. |

TYPICAL CHARACTERISTICS

Over operating temperature range ($T_J = -40^\circ\text{C}$ to $+125^\circ\text{C}$), $V_{IN} = V_{OUT(TYP)} + 0.3\text{V}$ or 2.7V , whichever is greater; $I_{OUT} = 1\text{mA}$, $V_{EN} = V_{IN}$, $C_{OUT} = 2.2\mu\text{F}$, $C_{NR} = 0.01\mu\text{F}$, unless otherwise noted. For TPS79901, $V_{OUT} = 3.0\text{V}$. Typical values are at $T_J = +25^\circ\text{C}$.

LOAD REGULATION

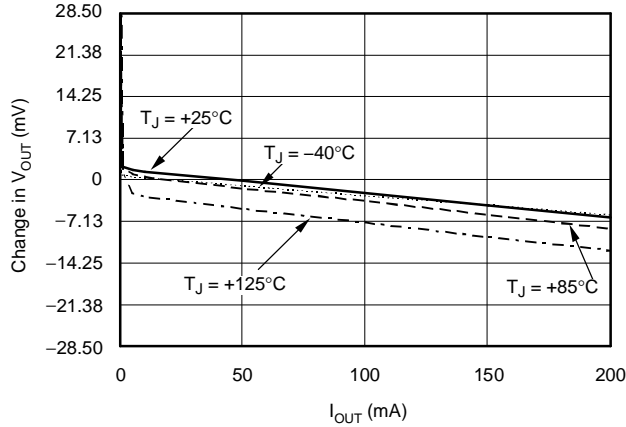

Figure 3.

LINE REGULATION

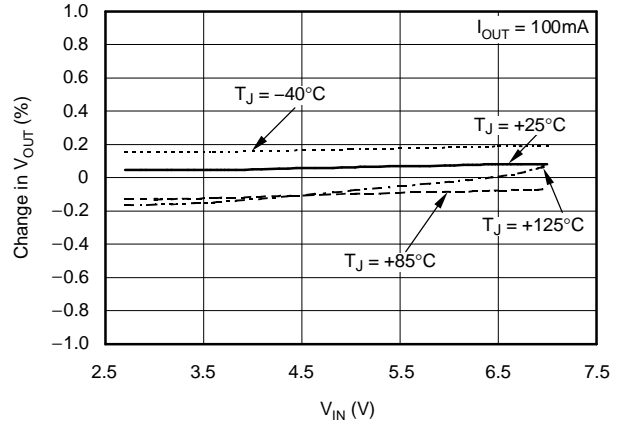

Figure 4.

OUTPUT VOLTAGE vs JUNCTION TEMPERATURE

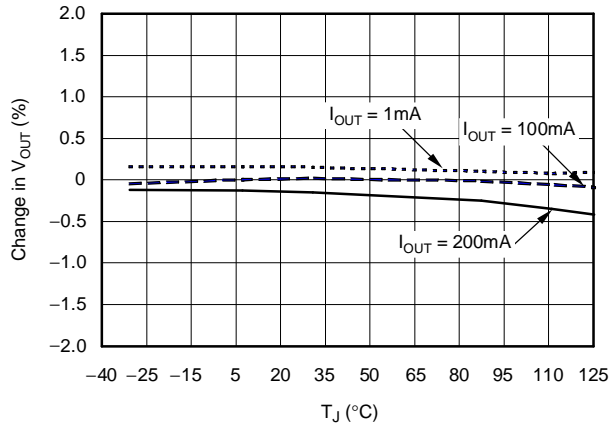

Figure 5.

TPS799285 DROPOUT VOLTAGE vs OUTPUT CURRENT

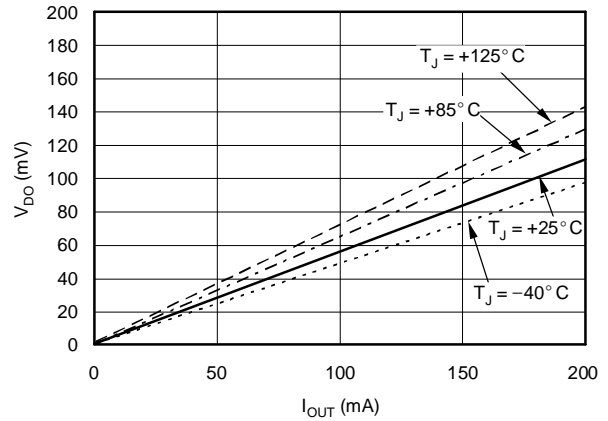

Figure 6.

TPS799285 DROPOUT VOLTAGE vs JUNCTION TEMPERATURE

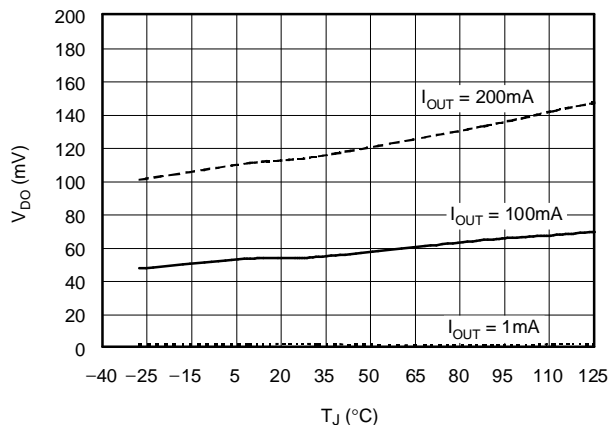

Figure 7.

TPS79901 DROPOUT vs INPUT VOLTAGE

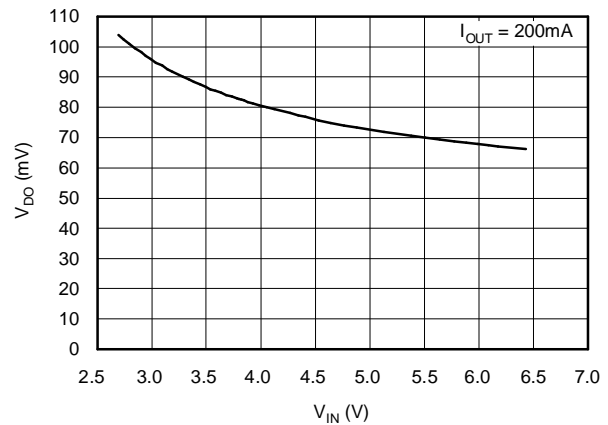

Figure 8.

TYPICAL CHARACTERISTICS (continued)

Over operating temperature range ($T_J = -40^{\circ}\text{C}$ to $+125^{\circ}\text{C}$), $V_{IN} = V_{OUT(TYP)} + 0.3\text{V}$ or 2.7V , whichever is greater; $I_{OUT} = 1\text{mA}$, $V_{EN} = V_{IN}$, $C_{OUT} = 2.2\mu\text{F}$, $C_{NR} = 0.01\mu\text{F}$, unless otherwise noted. For TPS79901, $V_{OUT} = 3.0\text{V}$. Typical values are at $T_J = +25^{\circ}\text{C}$.

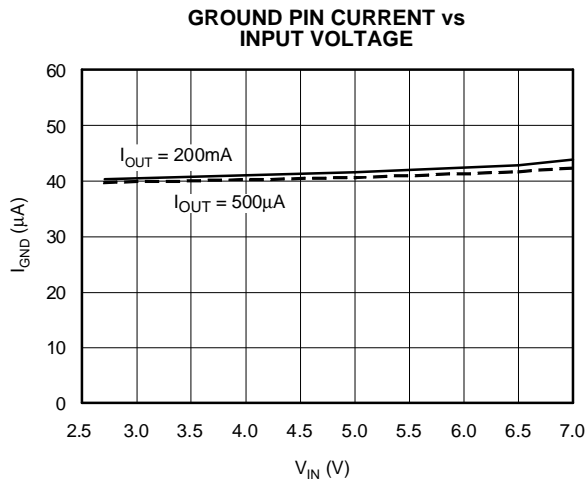

Figure 9.

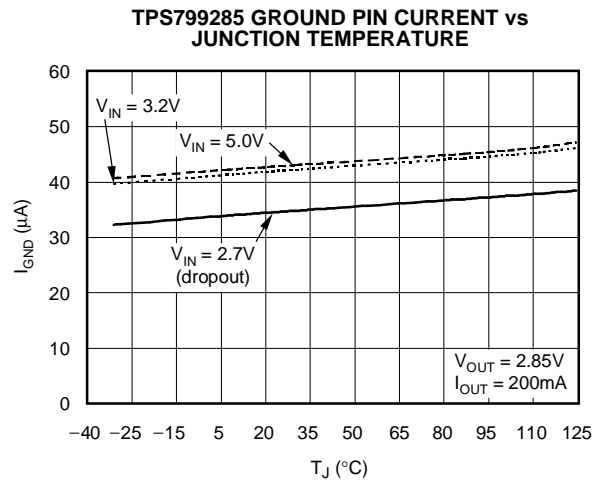

Figure 10.

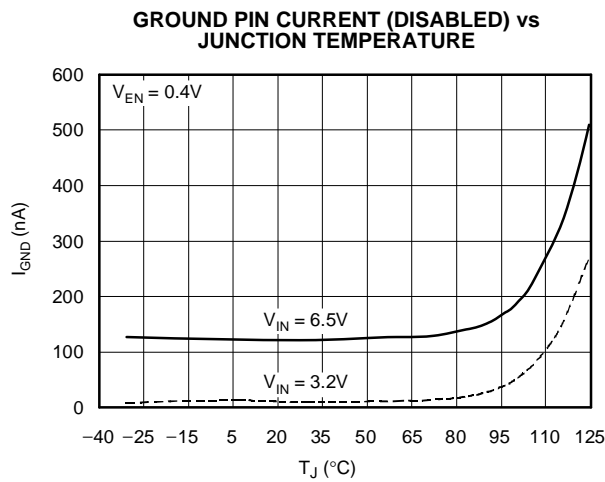

Figure 11.

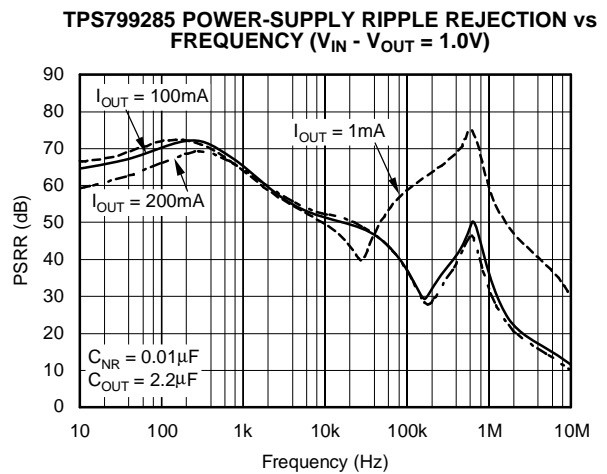

Figure 12.

TYPICAL CHARACTERISTICS (continued)

Over operating temperature range ($T_J = -40^\circ\text{C}$ to $+125^\circ\text{C}$), $V_{IN} = V_{OUT(TYP)} + 0.3\text{V}$ or 2.7V , whichever is greater; $I_{OUT} = 1\text{mA}$, $V_{EN} = V_{IN}$, $C_{OUT} = 2.2\mu\text{F}$, $C_{NR} = 0.01\mu\text{F}$, unless otherwise noted. For TPS79901, $V_{OUT} = 3.0\text{V}$. Typical values are at $T_J = +25^\circ\text{C}$.

TPS799285 POWER-SUPPLY RIPPLE REJECTION vs FREQUENCY ($V_{IN} - V_{OUT} = 0.5\text{V}$)

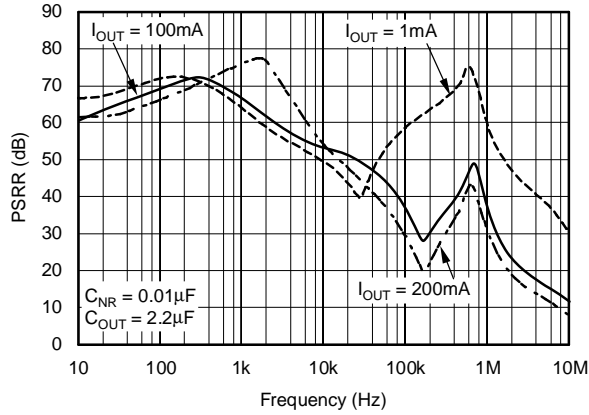

Figure 13.

TPS799285 POWER-SUPPLY RIPPLE REJECTION vs FREQUENCY ($V_{IN} - V_{OUT} = 0.25\text{V}$)

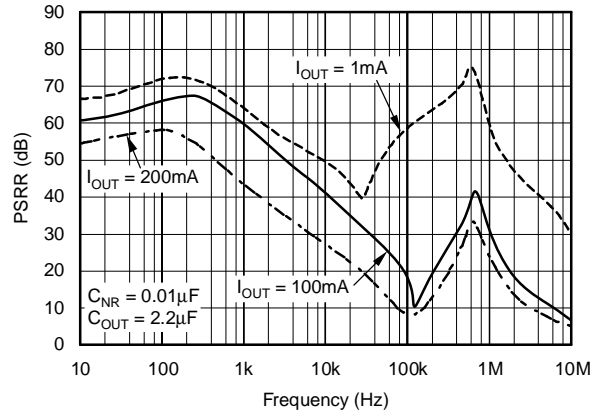

Figure 14.

TPS799285 POWER-SUPPLY RIPPLE REJECTION vs FREQUENCY ($V_{IN} - V_{OUT} = 1.0\text{V}$)

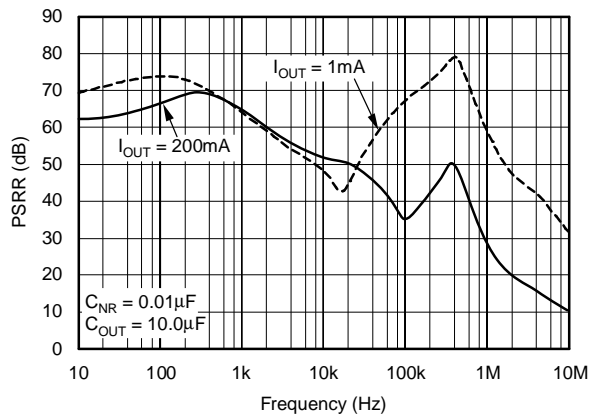

Figure 15.

TPS799285 POWER-SUPPLY RIPPLE REJECTION vs FREQUENCY ($V_{IN} - V_{OUT} = 0.25\text{V}$)

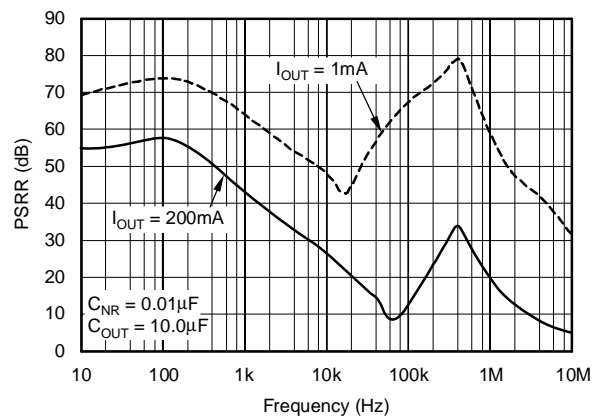

Figure 16.

TPS799285 POWER-SUPPLY RIPPLE REJECTION vs FREQUENCY ($V_{IN} - V_{OUT} = 1.0\text{V}$)

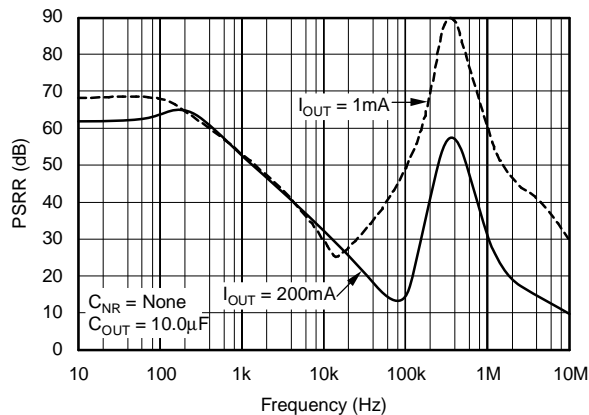

Figure 17.

POWER-SUPPLY RIPPLE REJECTION vs $V_{IN} - V_{OUT}$, $I_{OUT} = 1\text{mA}$

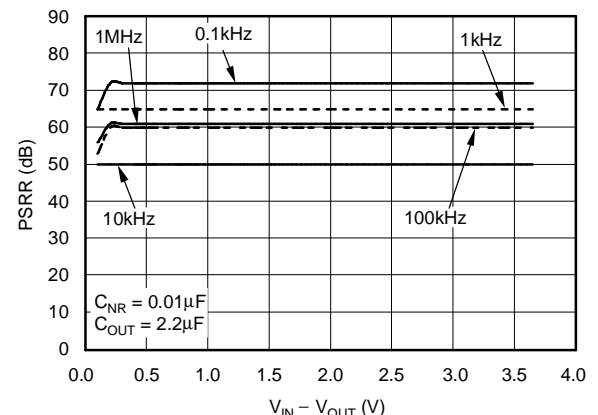

Figure 18.

TYPICAL CHARACTERISTICS (continued)

Over operating temperature range ($T_J = -40^\circ\text{C}$ to $+125^\circ\text{C}$), $V_{IN} = V_{OUT(TYP)} + 0.3\text{V}$ or 2.7V , whichever is greater; $I_{OUT} = 1\text{mA}$, $V_{EN} = V_{IN}$, $C_{OUT} = 2.2\mu\text{F}$, $C_{NR} = 0.01\mu\text{F}$, unless otherwise noted. For TPS79901, $V_{OUT} = 3.0\text{V}$. Typical values are at $T_J = +25^\circ\text{C}$.

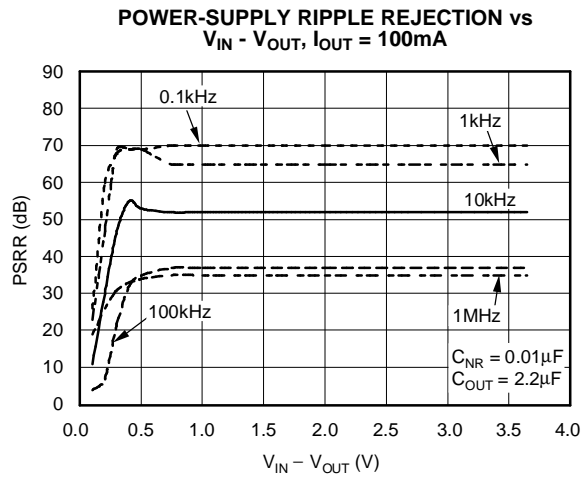

Figure 19.

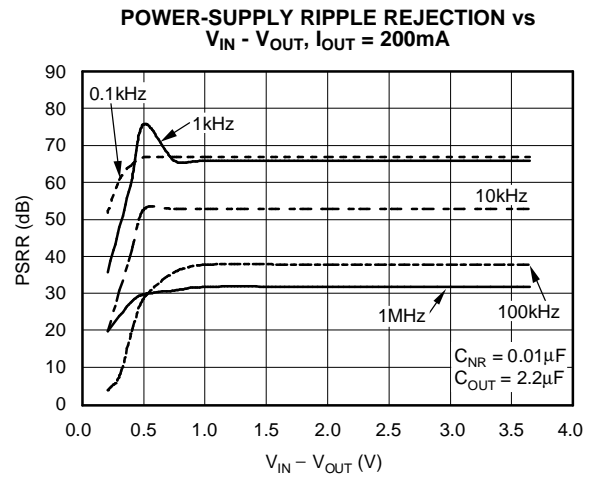

Figure 20.

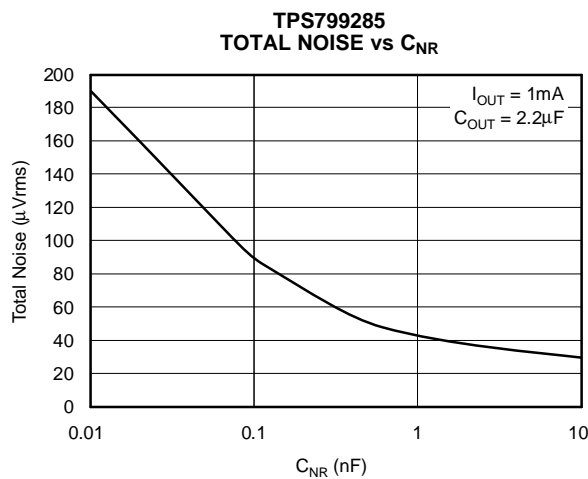

Figure 21.

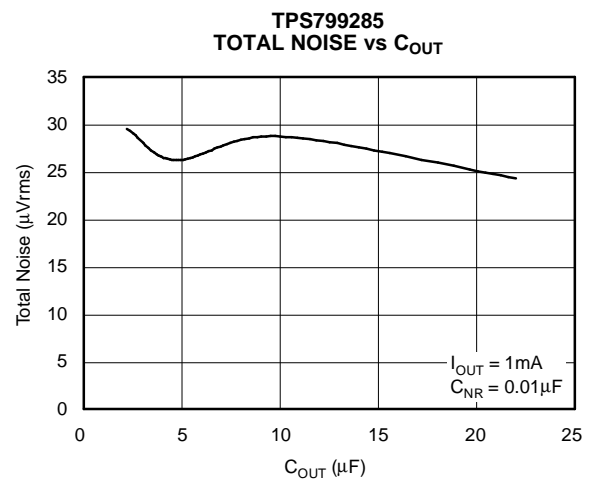

Figure 22.

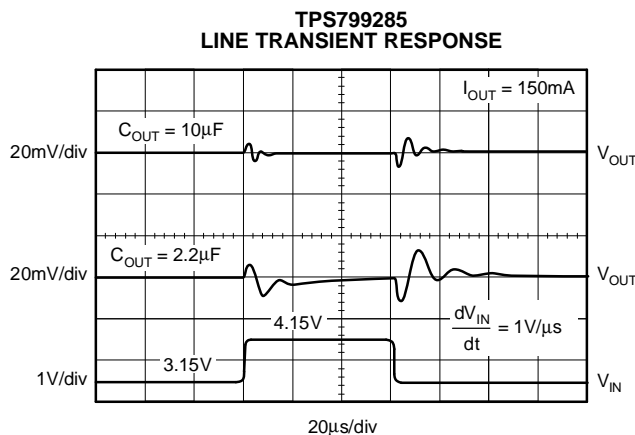

Figure 23.

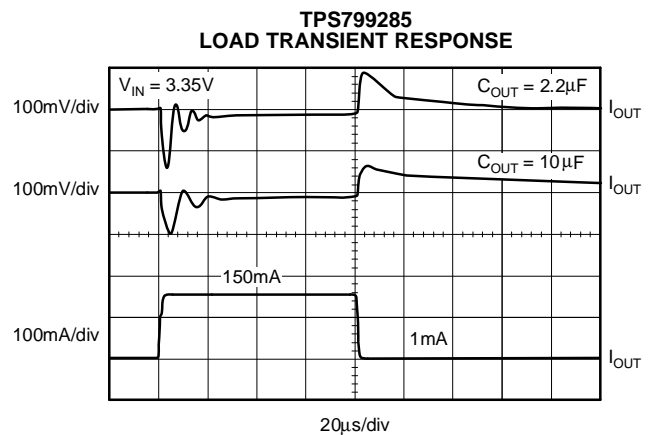

Figure 24.

TYPICAL CHARACTERISTICS (continued)

Over operating temperature range ($T_J = -40^\circ\text{C}$ to $+125^\circ\text{C}$), $V_{IN} = V_{OUT(TYP)} + 0.3\text{V}$ or 2.7V , whichever is greater; $I_{OUT} = 1\text{mA}$, $V_{EN} = V_{IN}$, $C_{OUT} = 2.2\mu\text{F}$, $C_{NR} = 0.01\mu\text{F}$, unless otherwise noted. For TPS79901, $V_{OUT} = 3.0\text{V}$. Typical values are at $T_J = +25^\circ\text{C}$.

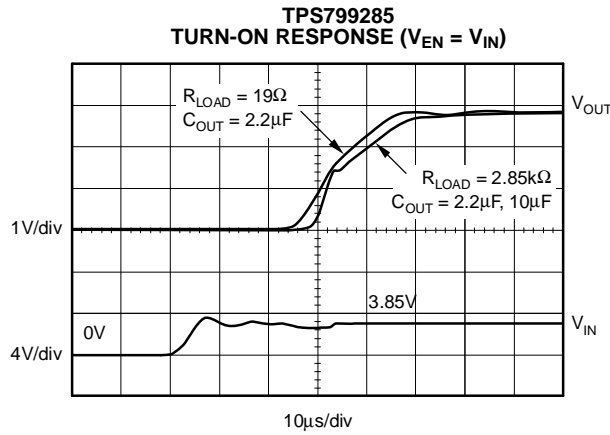

Figure 25.

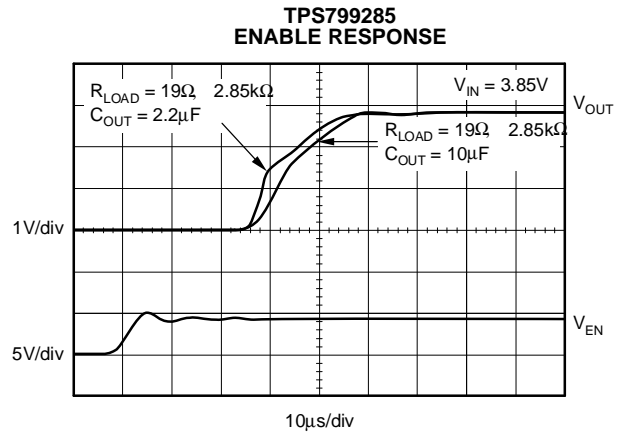

Figure 26.

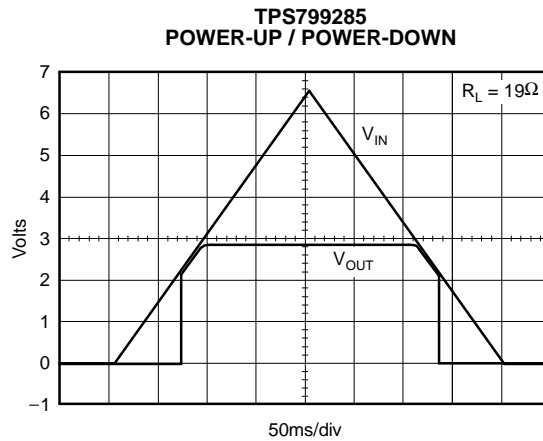

Figure 27.

APPLICATION INFORMATION

The TPS799xx family of LDO regulators combines the high performance required of many RF and precision analog applications with ultra-low current consumption. High PSRR is provided by a high gain, high bandwidth error loop with good supply rejection at very low headroom ($V_{IN} - V_{OUT}$). Fixed voltage versions provide a noise reduction pin to bypass noise generated by the bandgap reference and to improve PSRR while a quick-start circuit fast-charges this capacitor at startup for quick startup times. The combination of high performance and low ground current also make the TPS799xx an excellent choice for portable applications. All versions have thermal and over-current protection and are fully specified from -40°C to $+125^{\circ}\text{C}$.

Figure 28 shows the basic circuit connections for fixed voltage models. Figure 29 gives the connections for the adjustable output version (TPS79901). R_1 and R_2 can be calculated for any output voltage using the formula in Figure 29. Sample resistor values for common output voltages are shown in Figure 29.

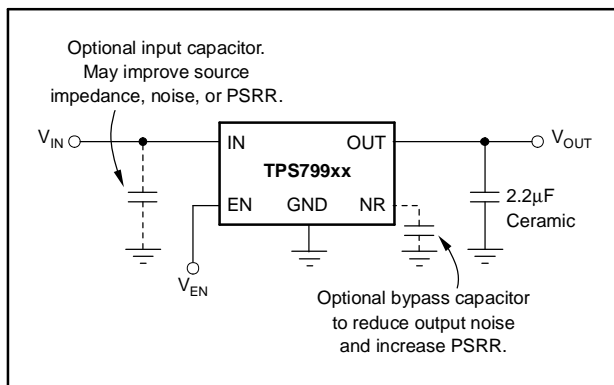

Figure 28. Typical Application Circuit for Fixed Voltage Versions

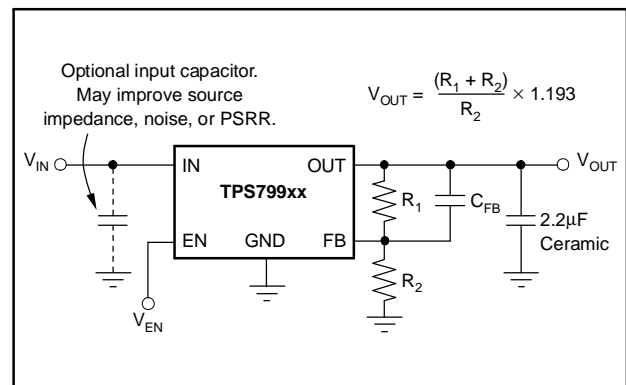

Figure 29. Typical Application Circuit for Adjustable Voltage Version

Input and Output Capacitor Requirements

Although an input capacitor is not required for stability, it is good analog design practice to connect a $0.1\mu\text{F}$ to $1\mu\text{F}$ low ESR capacitor across the input supply near the regulator. This will counteract reactive input sources and improve transient response, noise rejection, and ripple rejection. A higher-value capacitor may be necessary if large, fast rise-time load transients are anticipated or the device is located several inches from the power source. If source impedance is not sufficiently low, a $0.1\mu\text{F}$ input capacitor may be necessary to ensure stability.

The TPS799xx is designed to be stable with standard ceramic capacitors of values $2.2\mu\text{F}$ or larger. X5R and X7R type capacitors are best as they have minimal variation in value and ESR over temperature. Maximum ESR should be $< 1.0\Omega$.

Feedback Capacitor Requirements (TPS79901 only)

The feedback capacitor, C_{FB} , shown in Figure 29 is required for stability. For a parallel combination of R_1 and R_2 equal to $250\text{k}\Omega$, any value from 3pF to 1nF can be used. Fixed voltage versions have an internal 30pF feedback capacitor which is quick-charged at start-up. The adjustable version does not have this quick-charge circuit, so values below 5pF should be used to ensure fast startup; values above 47pF can be used to implement an output voltage soft-start. Larger value capacitors also improve noise slightly. The TPS79901 is stable in unity-gain configuration (OUT tied to FB) without C_{FB} .

Output Noise

In most LDOs, the bandgap is the dominant noise source. If a noise reduction capacitor (C_{NR}) is used with the TPS799xx, the bandgap does not contribute significantly to noise. Instead, noise is dominated by the output resistor divider and the error amplifier input. To minimize noise in a given application, use a $0.01\mu\text{F}$ noise reduction capacitor; for the adjustable version, smaller value resistors in the output resistor divider reduce noise. A parallel combination that gives $2\mu\text{A}$ of divider current will have the same noise performance as a fixed voltage version. To further optimize noise, equivalent series resistance of the output capacitor can be set to approximately 0.2Ω . This configuration maximizes phase margin in the control loop, reducing total output noise by up to 10%.

Noise can be referred to the feedback point (FB pin) such that with $C_{NR} = 0.01\mu\text{F}$ total noise is approximately given by [Equation 1](#):

$$V_N = \frac{10.7\mu\text{V}_{\text{RMS}}}{V} \times V_{\text{OUT}} \quad (1)$$

The TPS79901 adjustable version does not have the noise-reduction pin available, so ultra-low noise operation is not possible. Noise can be minimized according to the above recommendations.

Board Layout Recommendations to Improve PSRR and Noise Performance

To improve ac performance such as PSRR, output noise, and transient response, it is recommended that the board be designed with separate ground planes for V_{IN} and V_{OUT} , with each ground plane connected only at the GND pin of the device. In addition, the ground connection for the bypass capacitor should connect directly to the GND pin of the device.

Internal Current Limit

The TPS799xx internal current limit helps protect the regulator during fault conditions. During current limit, the output will source a fixed amount of current that is largely independent of output voltage. For reliable operation, the device should not be operated in current limit for extended periods of time.

The PMOS pass element in the TPS799xx has a built-in body diode that conducts current when the voltage at OUT exceeds the voltage at IN. This current is not limited, so if extended reverse voltage operation is anticipated, external limiting may be appropriate.

Shutdown

The enable pin (EN) is active high and is compatible with standard and low voltage TTL-CMOS levels. When shutdown capability is not required, EN can be connected to IN.

Dropout Voltage

The TPS799xx uses a PMOS pass transistor to achieve low dropout. When $(V_{\text{IN}} - V_{\text{OUT}})$ is less than the dropout voltage (V_{DO}), the PMOS pass device is in its linear region of operation and the input-to-output resistance is the $R_{\text{DS,ON}}$ of the PMOS pass element. Because the PMOS device behaves like a resistor in dropout, V_{DO} will approximately scale with output current.

As with any linear regulator, PSRR and transient response are degraded as $(V_{\text{IN}} - V_{\text{OUT}})$ approaches dropout. This effect is shown in [Figure 18](#) through [Figure 20](#) in the **Typical Characteristics** section.

Startup

Fixed voltage versions of the TPS799xx use a quick-start circuit to fast-charge the noise reduction capacitor, C_{NR} , if present (see *Functional Block Diagrams*, [Figure 1](#)). This allows the combination of very low output noise and fast start-up times. The NR pin is high impedance so a low leakage C_{NR} capacitor must be used; most ceramic capacitors are appropriate in this configuration.

Note that for fastest startup, V_{IN} should be applied first, then the enable pin (EN) driven high. If EN is tied to IN, startup will be somewhat slower. Refer to [Figure 25](#) and [Figure 26](#) in the **Typical Characteristics** section. The quick-start switch is closed for approximately $135\mu\text{s}$. To ensure that C_{NR} is fully charged during the quick-start time, a $0.01\mu\text{F}$ or smaller capacitor should be used.

Transient Response

As with any regulator, increasing the size of the output capacitor will reduce over/undershoot magnitude but increase duration of the transient response. In the adjustable version, adding C_{FB} between OUT and FB will improve stability and transient response. The transient response of the TPS799xx is enhanced by an active pull-down that engages when the output overshoots by approximately 5% or more when the device is enabled. When enabled, the pull-down device behaves like a 350 Ω resistor to ground.

Under-Voltage Lock-Out (UVLO)

The TPS799xx utilizes an under-voltage lock-out circuit to keep the output shut off until internal circuitry is operating properly. The UVLO circuit has a de-glitch feature so that it will typically ignore undershoot transients on the input if they are less than 50 μ s duration.

Minimum Load

The TPS799xx is stable and well-behaved with no output load. To meet the specified accuracy, a minimum load of 500 μ A is required. Below 500 μ A at junction temperatures near +125 $^{\circ}$ C, the output can drift up enough to cause the output pull-down to turn on. The output pull-down will limit voltage drift to 5% typically but ground current could increase by approximately 50 μ A. In typical applications, the junction cannot reach high temperatures at light loads since there is no appreciable dissipated power. The specified ground current would then be valid at no load in most applications.

Thermal Information

Thermal Protection

Thermal protection disables the output when the junction temperature rises to approximately +165 $^{\circ}$ C, allowing the device to cool. When the junction temperature cools to approximately +145 $^{\circ}$ C the output circuitry is again enabled. Depending on power dissipation, thermal resistance, and ambient temperature, the thermal protection circuit may cycle on and off. This cycling limits the dissipation of the regulator, protecting it from damage due to overheating.

Any tendency to activate the thermal protection circuit indicates excessive power dissipation or an inadequate heatsink. For reliable operation, junction temperature should be limited to +125 $^{\circ}$ C maximum. To estimate the margin of safety in a complete design (including heatsink), increase the ambient temperature until the thermal protection is triggered; use worst-case loads and signal conditions. For good reliability, thermal protection should trigger at least +35 $^{\circ}$ C above the maximum expected ambient condition of your particular application. This configuration produces a worst-case junction temperature of +125 $^{\circ}$ C at the highest expected ambient temperature and worst-case load.

The internal protection circuitry of the TPS799xx has been designed to protect against overload conditions. It was not intended to replace proper heatsinking. Continuously running the TPS799xx into thermal shutdown will degrade device reliability.

Power Dissipation

The ability to remove heat from the die is different for each package type, presenting different considerations in the PCB layout. The PCB area around the device that is free of other components moves the heat from the device to the ambient air. Performance data for JEDEC low- and high-K boards are given in the *Dissipation Ratings* table. Using heavier copper will increase the effectiveness in removing heat from the device. The addition of plated through-holes to heat-dissipating layers will also improve the heatsink effectiveness.

Power dissipation depends on input voltage and load conditions. Power dissipation is equal to the product of the output current times the voltage drop across the output pass element, as shown in [Equation 2](#):

$$P_D = (V_{IN} - V_{OUT}) \cdot I_{OUT} \quad (2)$$

Package Mounting

Solder pad footprint recommendations for the TPS799xx are available from the Texas Instruments' web site at www.ti.com.

Thermal Information (continued)

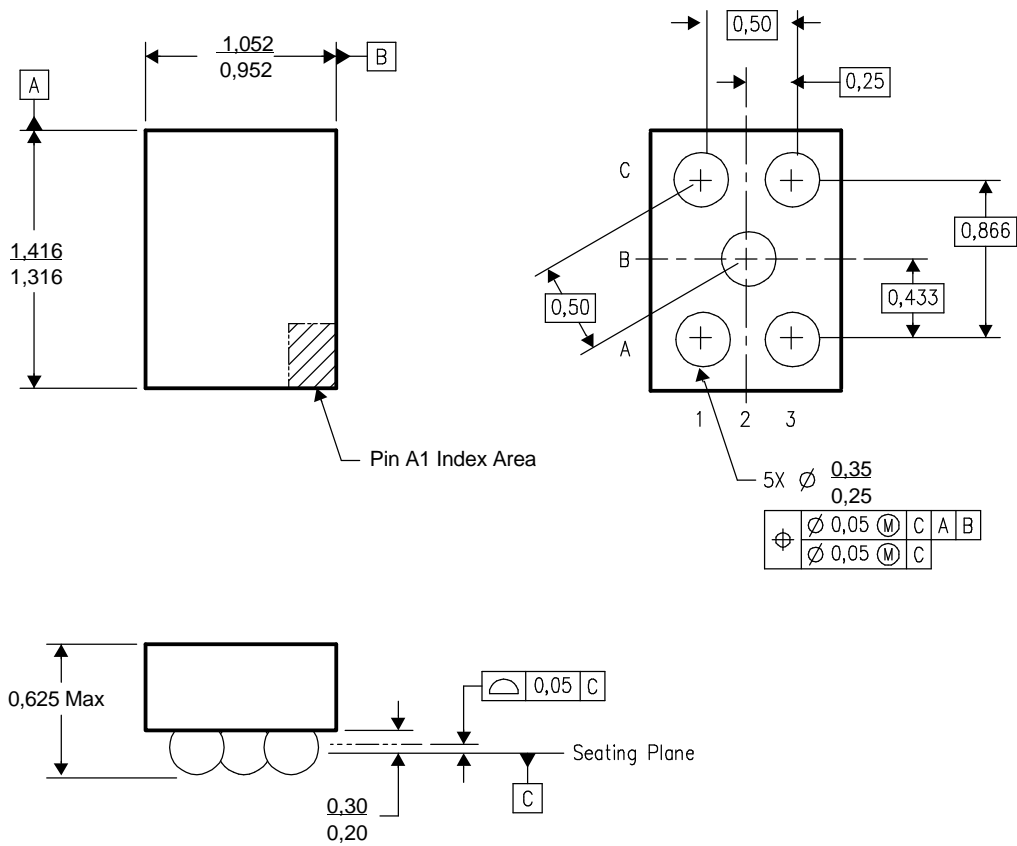

NOTES: A. All linear dimensions are in millimeters.
 B. This drawing is subject to change without notice.
 C. NanoStar™ package configuration.
 NanoStar is a trademark of Texas Instruments.

Figure 30. YZU Wafer Chip-Scale Preliminary Package Dimensions (mm)

THERMAL INFORMATION

This package incorporates an exposed thermal pad that is designed to be attached directly to an external heatsink. The thermal pad must be soldered directly to the printed circuit board (PCB), the PCB can be used as a heatsink. In addition, through the use of thermal vias, the thermal pad can be attached directly to a ground plane or special heatsink structure designed into the PCB. This design optimizes the heat transfer from the integrated circuit (IC).

For information on the Quad Flatpack No-Lead (QFN) package and its advantages, refer to Application Report, Quad Flatpack No-Lead Logic Packages, Texas Instruments Literature No. SCBA017. This document is available at www.ti.com.

The exposed thermal pad dimensions for this package are shown in the following illustration.

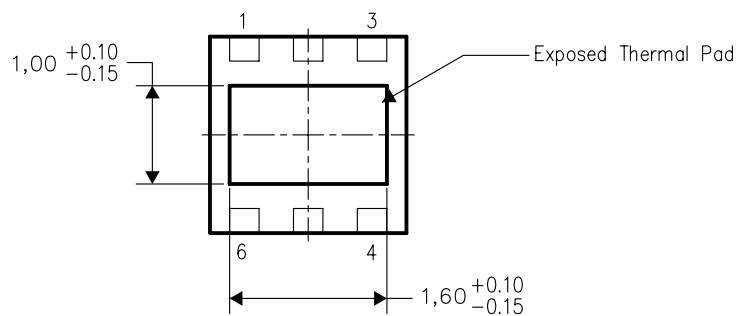

Bottom View

NOTE: All linear dimensions are in millimeters

Exposed Thermal Pad Dimensions

PACKAGING INFORMATION

| Orderable Device | Status ⁽¹⁾ | Package Type | Package Drawing | Pins | Package Qty | Eco Plan ⁽²⁾ | Lead/Ball Finish | MSL Peak Temp ⁽³⁾ |
|------------------|-----------------------|--------------|-----------------|------|-------------|-------------------------|------------------|------------------------------|
| TPS79901DDCR | ACTIVE | TO/SOT | DDC | 5 | 3000 | Green (RoHS & no Sb/Br) | CU NIPDAU | Level-1-260C-UNLIM |
| TPS79901DDCRG4 | ACTIVE | TO/SOT | DDC | 5 | 3000 | Green (RoHS & no Sb/Br) | CU NIPDAU | Level-1-260C-UNLIM |
| TPS79901DDCT | ACTIVE | TO/SOT | DDC | 5 | 250 | Green (RoHS & no Sb/Br) | CU NIPDAU | Level-1-260C-UNLIM |
| TPS79901DDCTG4 | ACTIVE | TO/SOT | DDC | 5 | 250 | Green (RoHS & no Sb/Br) | CU NIPDAU | Level-1-260C-UNLIM |
| TPS79901DRVR | ACTIVE | SON | DRV | 6 | 3000 | Green (RoHS & no Sb/Br) | CU NIPDAU | Level-1-260C-UNLIM |
| TPS79901DRVT | ACTIVE | SON | DRV | 6 | 250 | Green (RoHS & no Sb/Br) | CU NIPDAU | Level-1-260C-UNLIM |
| TPS79901YZUR | ACTIVE | DSBGA | YZU | 5 | 3000 | Green (RoHS & no Sb/Br) | SNAG | Level-1-260C-UNLIM |
| TPS79901YZUT | ACTIVE | DSBGA | YZU | 5 | 250 | Green (RoHS & no Sb/Br) | SNAG | Level-1-260C-UNLIM |
| TPS79912YZUR | ACTIVE | DSBGA | YZU | 5 | 3000 | Green (RoHS & no Sb/Br) | SNAG | Level-1-260C-UNLIM |
| TPS79912YZUT | ACTIVE | DSBGA | YZU | 5 | 250 | Green (RoHS & no Sb/Br) | SNAG | Level-1-260C-UNLIM |
| TPS79915DDCR | ACTIVE | TO/SOT | DDC | 5 | 3000 | Green (RoHS & no Sb/Br) | CU NIPDAU | Level-1-260C-UNLIM |
| TPS79915DDCRG4 | ACTIVE | TO/SOT | DDC | 5 | 3000 | Green (RoHS & no Sb/Br) | CU NIPDAU | Level-1-260C-UNLIM |
| TPS79915DDCT | ACTIVE | TO/SOT | DDC | 5 | 250 | Green (RoHS & no Sb/Br) | CU NIPDAU | Level-1-260C-UNLIM |
| TPS79915DDCTG4 | ACTIVE | TO/SOT | DDC | 5 | 250 | Green (RoHS & no Sb/Br) | CU NIPDAU | Level-1-260C-UNLIM |
| TPS79918DDCR | ACTIVE | TO/SOT | DDC | 5 | 3000 | Green (RoHS & no Sb/Br) | CU NIPDAU | Level-1-260C-UNLIM |
| TPS79918DDCRG4 | ACTIVE | TO/SOT | DDC | 5 | 3000 | Green (RoHS & no Sb/Br) | CU NIPDAU | Level-1-260C-UNLIM |
| TPS79918DDCT | ACTIVE | TO/SOT | DDC | 5 | 250 | Green (RoHS & no Sb/Br) | CU NIPDAU | Level-1-260C-UNLIM |
| TPS79918DDCTG4 | ACTIVE | TO/SOT | DDC | 5 | 250 | Green (RoHS & no Sb/Br) | CU NIPDAU | Level-1-260C-UNLIM |
| TPS79918DRVR | ACTIVE | SON | DRV | 6 | 3000 | Green (RoHS & no Sb/Br) | CU NIPDAU | Level-1-260C-UNLIM |
| TPS79918DRVT | ACTIVE | SON | DRV | 6 | 250 | Green (RoHS & no Sb/Br) | CU NIPDAU | Level-1-260C-UNLIM |
| TPS79918YZUR | ACTIVE | DSBGA | YZU | 5 | 3000 | Green (RoHS & no Sb/Br) | SNAG | Level-1-260C-UNLIM |
| TPS79918YZUT | ACTIVE | DSBGA | YZU | 5 | 250 | Green (RoHS & no Sb/Br) | SNAG | Level-1-260C-UNLIM |
| TPS79919YZUR | ACTIVE | DSBGA | YZU | 5 | 3000 | Green (RoHS & no Sb/Br) | SNAG | Level-1-260C-UNLIM |
| TPS79919YZUT | ACTIVE | DSBGA | YZU | 5 | 250 | Green (RoHS & no Sb/Br) | SNAG | Level-1-260C-UNLIM |
| TPS79925DDCR | ACTIVE | TO/SOT | DDC | 5 | 3000 | Green (RoHS & no Sb/Br) | CU NIPDAU | Level-1-260C-UNLIM |

| Orderable Device | Status ⁽¹⁾ | Package Type | Package Drawing | Pins | Package Qty | Eco Plan ⁽²⁾ | Lead/Ball Finish | MSL Peak Temp ⁽³⁾ |
|------------------|-----------------------|--------------|-----------------|------|-------------|-------------------------|------------------|------------------------------|
| TPS79925DDCRG4 | ACTIVE | TO/SOT | DDC | 5 | 3000 | Green (RoHS & no Sb/Br) | CU NIPDAU | Level-1-260C-UNLIM |
| TPS79925DDCT | ACTIVE | TO/SOT | DDC | 5 | 250 | Green (RoHS & no Sb/Br) | CU NIPDAU | Level-1-260C-UNLIM |
| TPS79925DDCTG4 | ACTIVE | TO/SOT | DDC | 5 | 250 | Green (RoHS & no Sb/Br) | CU NIPDAU | Level-1-260C-UNLIM |
| TPS79925YZUR | ACTIVE | DSBGA | YZU | 5 | 3000 | Green (RoHS & no Sb/Br) | SNAG | Level-1-260C-UNLIM |
| TPS79925YZUT | ACTIVE | DSBGA | YZU | 5 | 250 | Green (RoHS & no Sb/Br) | SNAG | Level-1-260C-UNLIM |
| TPS79927DRVR | ACTIVE | SON | DRV | 6 | 3000 | Green (RoHS & no Sb/Br) | CU NIPDAU | Level-1-260C-UNLIM |
| TPS79927DRVT | ACTIVE | SON | DRV | 6 | 250 | Green (RoHS & no Sb/Br) | CU NIPDAU | Level-1-260C-UNLIM |
| TPS79927YZUR | ACTIVE | DSBGA | YZU | 5 | 3000 | Green (RoHS & no Sb/Br) | SNAG | Level-1-260C-UNLIM |
| TPS79927YZUT | ACTIVE | DSBGA | YZU | 5 | 250 | Green (RoHS & no Sb/Br) | SNAG | Level-1-260C-UNLIM |
| TPS799285DDCR | ACTIVE | TO/SOT | DDC | 5 | 3000 | Green (RoHS & no Sb/Br) | CU NIPDAU | Level-1-260C-UNLIM |
| TPS799285DDCRG4 | ACTIVE | TO/SOT | DDC | 5 | 3000 | Green (RoHS & no Sb/Br) | CU NIPDAU | Level-1-260C-UNLIM |
| TPS799285DDCT | ACTIVE | TO/SOT | DDC | 5 | 250 | Green (RoHS & no Sb/Br) | CU NIPDAU | Level-1-260C-UNLIM |
| TPS799285DDCTG4 | ACTIVE | TO/SOT | DDC | 5 | 250 | Green (RoHS & no Sb/Br) | CU NIPDAU | Level-1-260C-UNLIM |
| TPS799285YZUR | ACTIVE | DSBGA | YZU | 5 | 3000 | Green (RoHS & no Sb/Br) | SNAG | Level-1-260C-UNLIM |
| TPS799285YZUT | ACTIVE | DSBGA | YZU | 5 | 250 | Green (RoHS & no Sb/Br) | SNAG | Level-1-260C-UNLIM |
| TPS79928DDCR | ACTIVE | TO/SOT | DDC | 5 | 3000 | Green (RoHS & no Sb/Br) | CU NIPDAU | Level-1-260C-UNLIM |
| TPS79928DDCRG4 | ACTIVE | TO/SOT | DDC | 5 | 3000 | Green (RoHS & no Sb/Br) | CU NIPDAU | Level-1-260C-UNLIM |
| TPS79928DDCT | ACTIVE | TO/SOT | DDC | 5 | 250 | Green (RoHS & no Sb/Br) | CU NIPDAU | Level-1-260C-UNLIM |
| TPS79928DDCTG4 | ACTIVE | TO/SOT | DDC | 5 | 250 | Green (RoHS & no Sb/Br) | CU NIPDAU | Level-1-260C-UNLIM |
| TPS79928DRVR | ACTIVE | SON | DRV | 6 | 3000 | Green (RoHS & no Sb/Br) | CU NIPDAU | Level-1-260C-UNLIM |
| TPS79928DRVT | ACTIVE | SON | DRV | 6 | 250 | Green (RoHS & no Sb/Br) | CU NIPDAU | Level-1-260C-UNLIM |
| TPS79928YZUR | ACTIVE | DSBGA | YZU | 5 | 3000 | Green (RoHS & no Sb/Br) | SNAG | Level-1-260C-UNLIM |
| TPS79928YZUT | ACTIVE | DSBGA | YZU | 5 | 250 | Green (RoHS & no Sb/Br) | SNAG | Level-1-260C-UNLIM |
| TPS79930DDCR | ACTIVE | TO/SOT | DDC | 5 | 3000 | Green (RoHS & no Sb/Br) | CU NIPDAU | Level-1-260C-UNLIM |
| TPS79930DDCRG4 | ACTIVE | TO/SOT | DDC | 5 | 3000 | Green (RoHS & no Sb/Br) | CU NIPDAU | Level-1-260C-UNLIM |
| TPS79930DDCT | ACTIVE | TO/SOT | DDC | 5 | 250 | Green (RoHS & no Sb/Br) | CU NIPDAU | Level-1-260C-UNLIM |

| Orderable Device | Status ⁽¹⁾ | Package Type | Package Drawing | Pins | Package Qty | Eco Plan ⁽²⁾ | Lead/Ball Finish | MSL Peak Temp ⁽³⁾ |
|------------------|-----------------------|--------------|-----------------|------|-------------|-------------------------|------------------|------------------------------|
| TPS79930DDCTG4 | ACTIVE | TO/SOT | DDC | 5 | 250 | Green (RoHS & no Sb/Br) | CU NIPDAU | Level-1-260C-UNLIM |
| TPS79930YZUR | ACTIVE | DSBGA | YZU | 5 | 3000 | Green (RoHS & no Sb/Br) | SNAG | Level-1-260C-UNLIM |
| TPS79930YZUT | ACTIVE | DSBGA | YZU | 5 | 250 | Green (RoHS & no Sb/Br) | SNAG | Level-1-260C-UNLIM |
| TPS79933DDCR | ACTIVE | TO/SOT | DDC | 5 | 3000 | Green (RoHS & no Sb/Br) | CU NIPDAU | Level-1-260C-UNLIM |
| TPS79933DDCRG4 | ACTIVE | TO/SOT | DDC | 5 | 3000 | Green (RoHS & no Sb/Br) | CU NIPDAU | Level-1-260C-UNLIM |
| TPS79933DDCT | ACTIVE | TO/SOT | DDC | 5 | 250 | Green (RoHS & no Sb/Br) | CU NIPDAU | Level-1-260C-UNLIM |
| TPS79933DDCTG4 | ACTIVE | TO/SOT | DDC | 5 | 250 | Green (RoHS & no Sb/Br) | CU NIPDAU | Level-1-260C-UNLIM |
| TPS79933YZUR | ACTIVE | DSBGA | YZU | 5 | 3000 | Green (RoHS & no Sb/Br) | SNAG | Level-1-260C-UNLIM |
| TPS79933YZUT | ACTIVE | DSBGA | YZU | 5 | 250 | Green (RoHS & no Sb/Br) | SNAG | Level-1-260C-UNLIM |

⁽¹⁾ The marketing status values are defined as follows:

ACTIVE: Product device recommended for new designs.

LIFEBUY: TI has announced that the device will be discontinued, and a lifetime-buy period is in effect.

NRND: Not recommended for new designs. Device is in production to support existing customers, but TI does not recommend using this part in a new design.

PREVIEW: Device has been announced but is not in production. Samples may or may not be available.

OBSOLETE: TI has discontinued the production of the device.

⁽²⁾ Eco Plan - The planned eco-friendly classification: Pb-Free (RoHS) or Green (RoHS & no Sb/Br) - please check <http://www.ti.com/productcontent> for the latest availability information and additional product content details.

TBD: The Pb-Free/Green conversion plan has not been defined.

Pb-Free (RoHS): TI's terms "Lead-Free" or "Pb-Free" mean semiconductor products that are compatible with the current RoHS requirements for all 6 substances, including the requirement that lead not exceed 0.1% by weight in homogeneous materials. Where designed to be soldered at high temperatures, TI Pb-Free products are suitable for use in specified lead-free processes.

Green (RoHS & no Sb/Br): TI defines "Green" to mean Pb-Free (RoHS compatible), and free of Bromine (Br) and Antimony (Sb) based flame retardants (Br or Sb do not exceed 0.1% by weight in homogeneous material)

⁽³⁾ MSL, Peak Temp. -- The Moisture Sensitivity Level rating according to the JEDEC industry standard classifications, and peak solder temperature.

Important Information and Disclaimer:The information provided on this page represents TI's knowledge and belief as of the date that it is provided. TI bases its knowledge and belief on information provided by third parties, and makes no representation or warranty as to the accuracy of such information. Efforts are underway to better integrate information from third parties. TI has taken and continues to take reasonable steps to provide representative and accurate information but may not have conducted destructive testing or chemical analysis on incoming materials and chemicals. TI and TI suppliers consider certain information to be proprietary, and thus CAS numbers and other limited information may not be available for release.

In no event shall TI's liability arising out of such information exceed the total purchase price of the TI part(s) at issue in this document sold by TI to Customer on an annual basis.

DRV (S-PDSO-N6)

PLASTIC SMALL OUTLINE

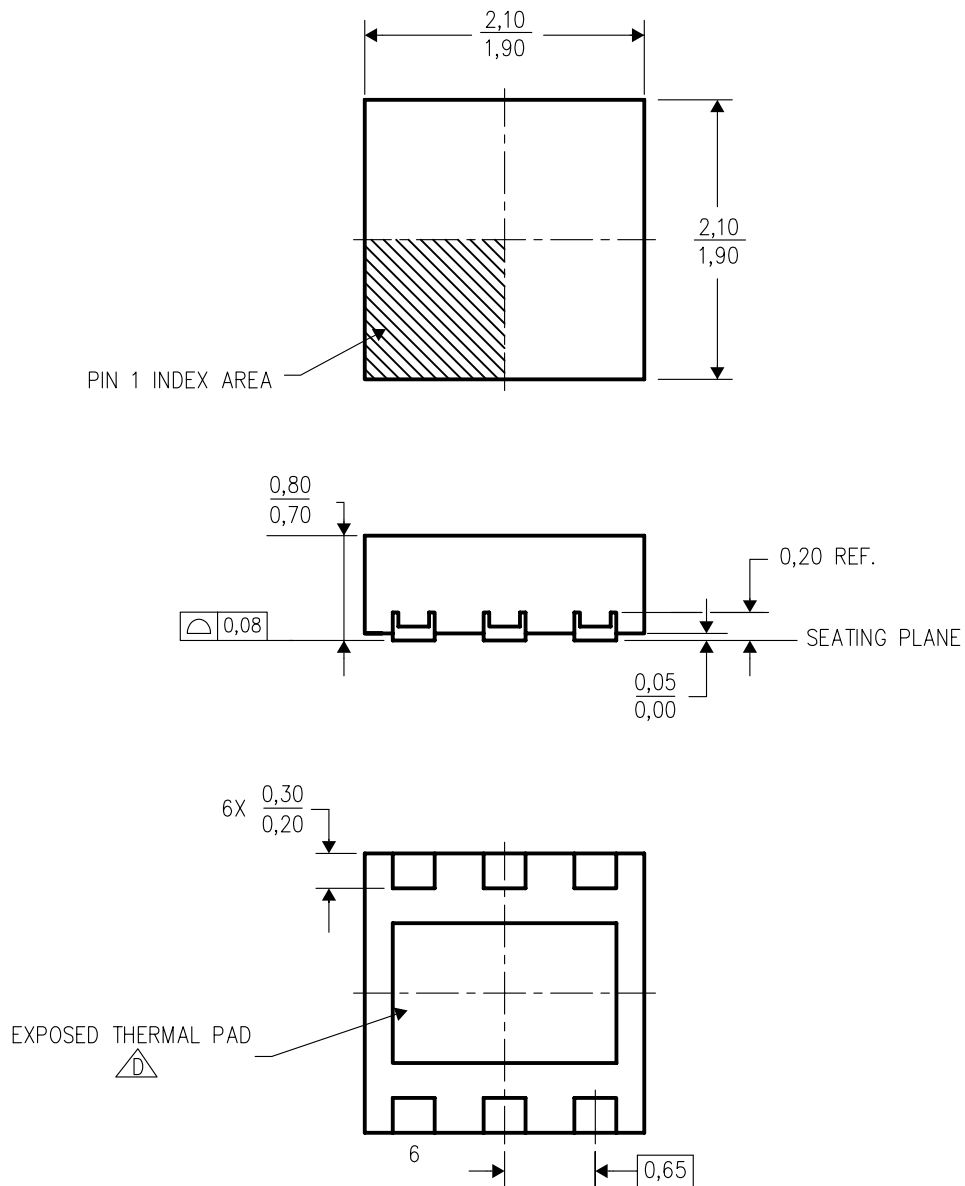

4206925/B 06/05

- NOTES:
- A. All linear dimensions are in millimeters.
 - B. This drawing is subject to change without notice.
 - C. Small Outline No-Lead (SON) package configuration.
 -  The package thermal pad must be soldered to the board for thermal and mechanical performance. See the Product Data Sheet for details regarding the exposed thermal pad dimensions.

YZU (R-XBGA-N5)

DIE-SIZE BALL GRID ARRAY

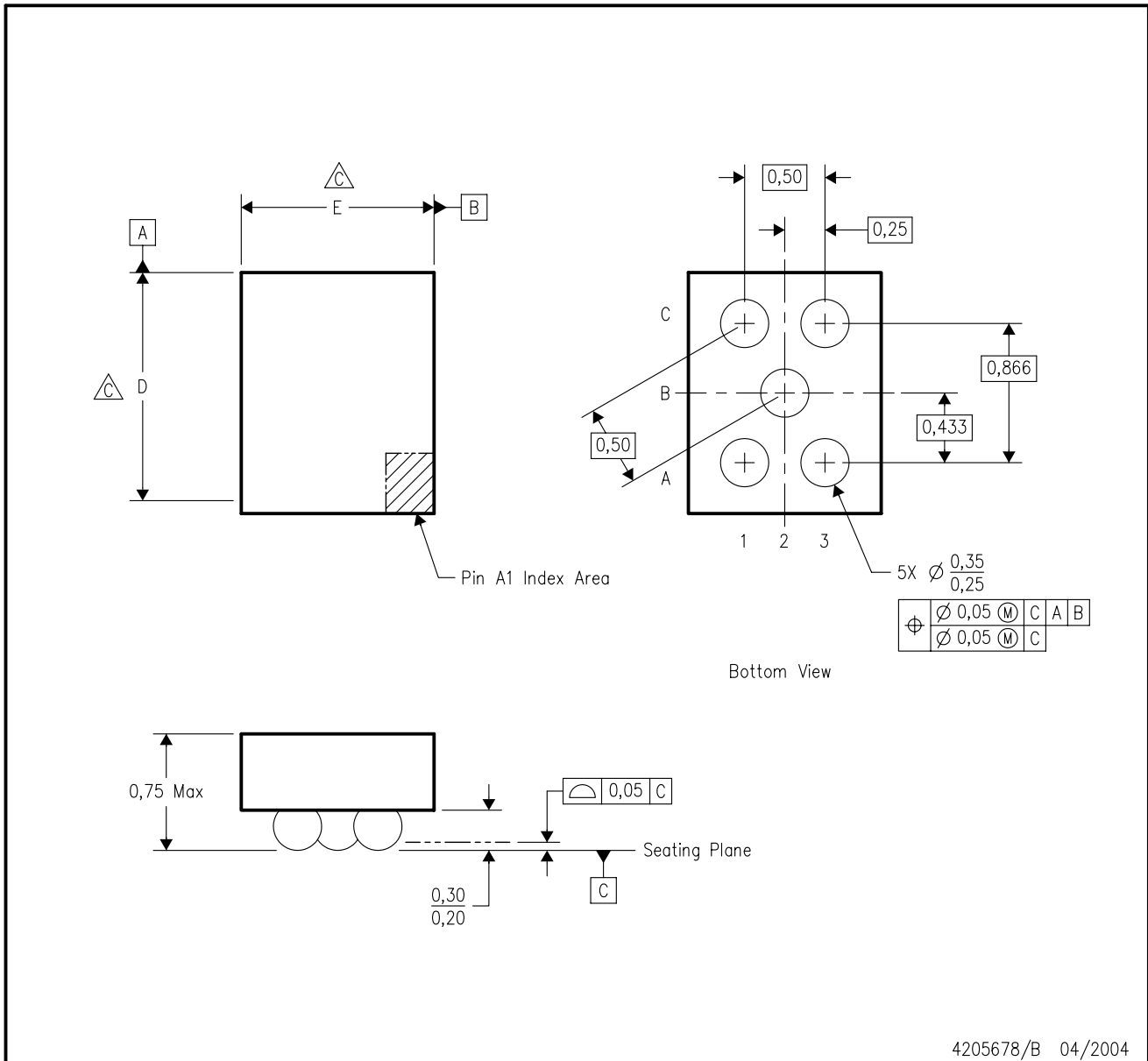

- Notes:
- A. All linear dimensions are in millimeters.
 - B. This drawing is subject to change without notice.
 - △ Devices in this YZQ package can have dimension D ranging from 1.25 to 1.75 and dimension E ranging from 0.95 to 1.45. To determine the exact package size of a particular device, refer to the device datasheet or contact a local TI representative.
 - D. NanoFree™ package configuration.
 - E. This package contains lead-free balls. Refer to the 5 YEU package (drawing 4205430) for tin-lead (SnPb) balls.

NanoFree is a trademark of Texas Instruments.

IMPORTANT NOTICE

Texas Instruments Incorporated and its subsidiaries (TI) reserve the right to make corrections, modifications, enhancements, improvements, and other changes to its products and services at any time and to discontinue any product or service without notice. Customers should obtain the latest relevant information before placing orders and should verify that such information is current and complete. All products are sold subject to TI's terms and conditions of sale supplied at the time of order acknowledgment.

TI warrants performance of its hardware products to the specifications applicable at the time of sale in accordance with TI's standard warranty. Testing and other quality control techniques are used to the extent TI deems necessary to support this warranty. Except where mandated by government requirements, testing of all parameters of each product is not necessarily performed.

TI assumes no liability for applications assistance or customer product design. Customers are responsible for their products and applications using TI components. To minimize the risks associated with customer products and applications, customers should provide adequate design and operating safeguards.

TI does not warrant or represent that any license, either express or implied, is granted under any TI patent right, copyright, mask work right, or other TI intellectual property right relating to any combination, machine, or process in which TI products or services are used. Information published by TI regarding third-party products or services does not constitute a license from TI to use such products or services or a warranty or endorsement thereof. Use of such information may require a license from a third party under the patents or other intellectual property of the third party, or a license from TI under the patents or other intellectual property of TI.

Reproduction of information in TI data books or data sheets is permissible only if reproduction is without alteration and is accompanied by all associated warranties, conditions, limitations, and notices. Reproduction of this information with alteration is an unfair and deceptive business practice. TI is not responsible or liable for such altered documentation.

Resale of TI products or services with statements different from or beyond the parameters stated by TI for that product or service voids all express and any implied warranties for the associated TI product or service and is an unfair and deceptive business practice. TI is not responsible or liable for any such statements.

Following are URLs where you can obtain information on other Texas Instruments products and application solutions:

| Products | | Applications | |
|------------------|--|---------------------|--|
| Amplifiers | amplifier.ti.com | Audio | www.ti.com/audio |
| Data Converters | dataconverter.ti.com | Automotive | www.ti.com/automotive |
| DSP | dsp.ti.com | Broadband | www.ti.com/broadband |
| Interface | interface.ti.com | Digital Control | www.ti.com/digitalcontrol |
| Logic | logic.ti.com | Military | www.ti.com/military |
| Power Mgmt | power.ti.com | Optical Networking | www.ti.com/opticalnetwork |
| Microcontrollers | microcontroller.ti.com | Security | www.ti.com/security |
| | | Telephony | www.ti.com/telephony |
| | | Video & Imaging | www.ti.com/video |
| | | Wireless | www.ti.com/wireless |

Mailing Address: Texas Instruments
Post Office Box 655303 Dallas, Texas 75265