



## Low Quiescent Current, Dual-Channel Supervisory Circuit

### FEATURES

- Two Supply Monitors in One Package
- One Monitor with Fixed High-Accuracy Thresholds for System Supply Monitoring
- Second Monitor with Variable Threshold and 30mV Hysteresis to Provide Failsafe
- Very Low Quiescent Current: 3.5µA typ
- High Threshold Accuracy: 1% max (0°C to +85°C)
- Open-Drain Reset Outputs
- Temperature Range: –40°C to +85°C
- Ultra-Small SC70-5 Package

### APPLICATIONS

- DSP, Microcontroller, or Microprocessor Applications Requiring User-Selected Delay Times
- Notebook/Desktop Computers
- PDAs and SmartPhones
- Other Hand-Held Products
- Portable, Battery-Powered Products
- FPGA/ASIC Applications

### DESCRIPTION

The TPS3807 family microprocessor supervisory circuits monitor system voltages as low as 1.225V. These devices assert an open-drain  $\overline{\text{RSTVDD}}$  signal when the  $V_{\text{DD}}$  voltage drops below a preset threshold. The  $\overline{\text{RSTVDD}}$  output remains asserted until the  $V_{\text{DD}}$  voltage returns above its threshold. The device also provides an additional  $\overline{\text{RSTSENSE}}$  output for a SENSE input with adjustable thresholds and hysteresis.

The TPS3807 uses a precision reference to achieve 1% threshold accuracy. The TPS3807 has a very low typical quiescent current of 3.5µA, so it is well-suited to battery-powered applications. It is available in a small SC70-5 package, which is half the size of a SOT-23 package, and is fully specified over a temperature range of –40°C to +85°C.

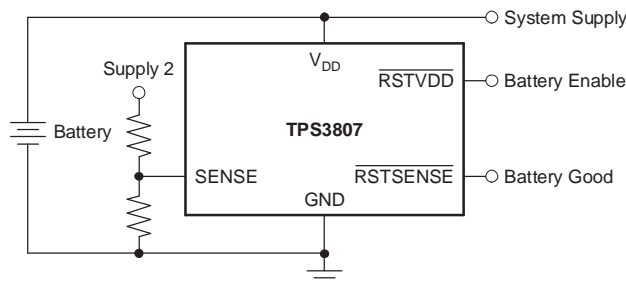

Typical Application Circuit

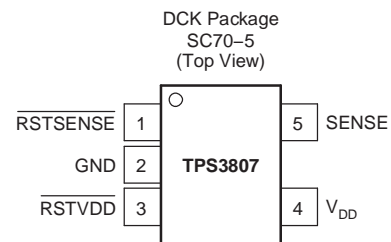

Please be aware that an important notice concerning availability, standard warranty, and use in critical applications of Texas Instruments semiconductor products and disclaimers thereto appears at the end of this data sheet.

All trademarks are the property of their respective owners.



This integrated circuit can be damaged by ESD. Texas Instruments recommends that all integrated circuits be handled with appropriate precautions. Failure to observe proper handling and installation procedures can cause damage.

ESD damage can range from subtle performance degradation to complete device failure. Precision integrated circuits may be more susceptible to damage because very small parametric changes could cause the device not to meet its published specifications.

### ORDERING INFORMATION<sup>(1)</sup>

PRODUCT	V <sub>DD</sub> NEGATIVE THRESHOLD VOLTAGE (V <sub>DD IT-</sub> ) <sup>(2)</sup>	V <sub>DD</sub> POSITIVE THRESHOLD VOLTAGE (V <sub>DD IT+</sub> ) <sup>(2)</sup>	SENSE THRESHOLD VOLTAGE (V <sub>SENSE IT</sub> )
TPS3807A30DCKT <sup>(3)</sup>	3.00V	3.58V	1.225V
TPS3807A30DCKR <sup>(4)</sup>	3.00V	3.58V	1.225V

- (1) For the most current package and ordering information, see the Package Option Addendum at the end of this document or see the TI web site at [www.ti.com](http://www.ti.com).
- (2) Other voltage options are available upon request; minimum order quantities may apply.
- (3) DCKT passive indicates tape and reel containing 250 parts.
- (4) The DCKR passive indicates tape and reel containing 3000 parts.

### ABSOLUTE MAXIMUM RATINGS

Over operating free-air temperature range, unless otherwise noted.<sup>(1)</sup>

SENSE pin voltage <sup>(2)</sup>	-0.3V to +5V
$\overline{MR}$	-0.3V to V <sub>DD</sub> +0.3V
RESET	-0.3V to V <sub>DD</sub> +0.3V
All other pins <sup>(2)</sup>	-0.3V to +7V
Maximum output current	±5mA
Input clamp current, I <sub>IK</sub> (V <sub>SENSE</sub> < 0 or V <sub>SENSE</sub> > V <sub>DD</sub> )	±10mA
Output clamp current, I <sub>OK</sub> (V <sub>O</sub> < 0 or V <sub>O</sub> > V <sub>DD</sub> )	±10mA
Continuous total power dissipation	See <i>Dissipation Ratings</i> table
Junction temperature, T <sub>C</sub>	-40°C to +125°C
Storage temperature range, T <sub>STG</sub>	-65°C to +150°C
Soldering temperature	+260°C
ESD rating:	
Human body model (HBM)	2kV
Charged device model (CDM)	500V

- (1) Stresses beyond those listed under *absolute maximum ratings* may cause permanent damage to the device. These are stress ratings only and functional operation of the device at these conditions is not implied. Exposure to absolute-maximum-rated conditions for extended periods may affect device reliability.
- (2) All voltage values are with respect to GND. For reliable operation, the device must not be continuously operated at 7V for more than t = 1000 hours.

### DISSIPATION RATINGS

PACKAGE	θ <sub>JA</sub>	DERATING FACTOR ABOVE T <sub>A</sub> = +25°C	T <sub>A</sub> < +25°C POWER RATING	T <sub>A</sub> = +70°C POWER RATING	T <sub>A</sub> = +80°C POWER RATING
DCK	+246°C/W	2.6mW/°C	406mW	223mW	167mW

### RECOMMENDED OPERATING CONDITIONS

		MIN	MAX	UNIT
Supply voltage, V <sub>DD</sub>		1.8	6.5	V
Input voltage, V <sub>SENSE</sub>	0V ≤ V <sub>DD</sub> ≤ 4.2V	0	V <sub>DD</sub> + 0.3	V
	V <sub>DD</sub> ≥ 4.2V		4.5	
Operating free-air temperature range, T <sub>A</sub>		-40°C	+85°C	°C

## ELECTRICAL CHARACTERISTICS

Over recommended operating temperature range, unless otherwise noted.

PARAMETER	TEST CONDITIONS	MIN	TYP	MAX	UNIT
V <sub>DD</sub> Input supply range		1.8		6.5	V
I <sub>DD</sub> Supply current	V <sub>DD</sub> = 3.3V RSTVDD, RSTSENSE = open		3.5	6.5	μA
	V <sub>DD</sub> = 6.5V RSTVDD, RSTSENSE = open		4.5	7.5	μA
V <sub>OL</sub> Low-level output voltage	V <sub>DD</sub> = 1.3V, I <sub>OL</sub> = 0.4mA			0.3	V
	V <sub>DD</sub> = 1.8V, I <sub>OL</sub> = 1mA			0.4	
	V <sub>DD</sub> = 3.3V, I <sub>OL</sub> = 2mA			0.4	
Power-up reset <sup>(1)</sup>	V <sub>RSTVDD</sub> (max) = 0.2V, I <sub>OL</sub> = 30μA, +25°C	0.9			V
V <sub>DD IT-</sub> Negative-going input threshold voltage <sup>(2)</sup>		2.963	3.000	3.037	V
V <sub>DD IT+</sub> Positive-going input threshold voltage <sup>(2)</sup>		3.530	3.575	3.620	V
V <sub>SENSE IT-</sub> Negative-going input threshold voltage	0°C to +85°C	1.213	1.225	1.237	V
	-40°C to +85°C	1.210	1.225	1.240	
V <sub>HYS</sub> SENSE input hysteresis			30		mV
I <sub>SENSE</sub> Input current		-25		+25	nA
C <sub>I</sub> Input capacitance	V <sub>I</sub> = 0V to V <sub>DD</sub>		1		pF
I <sub>OH</sub> High-level output current	V <sub>RSTVDD</sub> , RSTSENSE = 6.5V			300	nA

(1) The lowest supply voltage at which RSTVDD (V<sub>RSTVDD</sub> (max) = 0.2V, I<sub>OL</sub> = 30μA) becomes active. t<sub>r, VDD</sub> ≥ 15μs/V.

(2) To ensure best stability of the threshold voltage, a bypass capacitor (ceramic, 0.1μF) should be placed near the V<sub>DD</sub> pin.

## TIMING REQUIREMENTS

At T<sub>A</sub> = -40°C to +85°C, R<sub>L</sub> = 1MΩ, and C<sub>L</sub> = 50pF, unless otherwise noted.

PARAMETER	TEST CONDITIONS	MIN	TYP	MAX	UNIT
t <sub>W</sub> Pulse width	V <sub>IH</sub> = 1.05V <sub>IT</sub> , V <sub>IL</sub> = 0.95V <sub>IT</sub>	10			μs

## SWITCHING CHARACTERISTICS

At T<sub>A</sub> = -40°C to +85°C, R<sub>L</sub> = 1MΩ, and C<sub>L</sub> = 50pF, unless otherwise noted.

PARAMETER	TEST CONDITIONS	MIN	TYP	MAX	UNIT
t <sub>PHL</sub> Propagation delay time, high-to-low-level output	V <sub>DD</sub> to RSTVDD	V <sub>IH</sub> = 1.05V <sub>IT</sub> , V <sub>IL</sub> = 0.95V <sub>IT</sub>	20		μs
	SENSE to RSTSENSE				

FUNCTIONAL BLOCK DIAGRAM

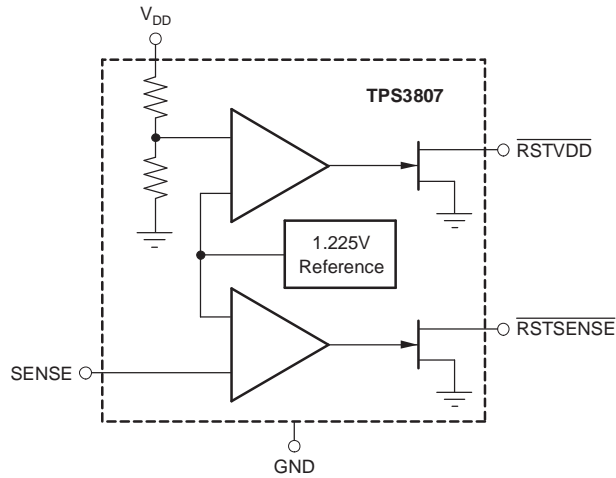

Table 1. PIN DESCRIPTIONS

NAME	PIN NO.	I/O	DESCRIPTION
$\overline{\text{RSTSENSE}}$	1	O	$\overline{\text{RSTSENSE}}$ is an open-drain output that is driven to a low-impedance state when the SENSE input is lower than the threshold voltage $V_{\text{SENSE IT-}}$ . $\overline{\text{RSTSENSE}}$ will remain low until SENSE is above $V_{\text{SENSE IT+}}$ . A pull-up resistor from 10k $\Omega$ to 1M $\Omega$ should be used on this pin, and allows the reset pin to attain voltages higher than $V_{\text{DD}}$ .
GND	2	I	Ground
$\overline{\text{RSTVDD}}$	3	O	$\overline{\text{RSTVDD}}$ is an open-drain output that is driven to a low-impedance state when the $V_{\text{DD}}$ input is lower than the threshold voltage $V_{\text{DD IT-}}$ . $\overline{\text{RSTVDD}}$ will remain low until $V_{\text{DD}}$ is above $V_{\text{DD IT+}}$ . A pull-up resistor from 10k $\Omega$ to 1M $\Omega$ should be used on this pin, and allows the reset pin to attain voltages higher than $V_{\text{DD}}$ .
$V_{\text{DD}}$	4	I	Supply voltage for the device and sense input for fixed-threshold $\overline{\text{RSTVDD}}$ outputs. A 0.1 $\mu\text{F}$ ceramic capacitor should be placed close to this pin for best $V_{\text{IT}}$ stability.
SENSE	5	I	Sense input for the adjustable-threshold $\overline{\text{RSTSENSE}}$ outputs. A resistor divider from the sense voltage can be attached to this pin to set the thresholds to the desired voltages. A 0.1 $\mu\text{F}$ ceramic capacitor should be placed close to this pin for best $V_{\text{IT}}$ stability.

TIMING DIAGRAM

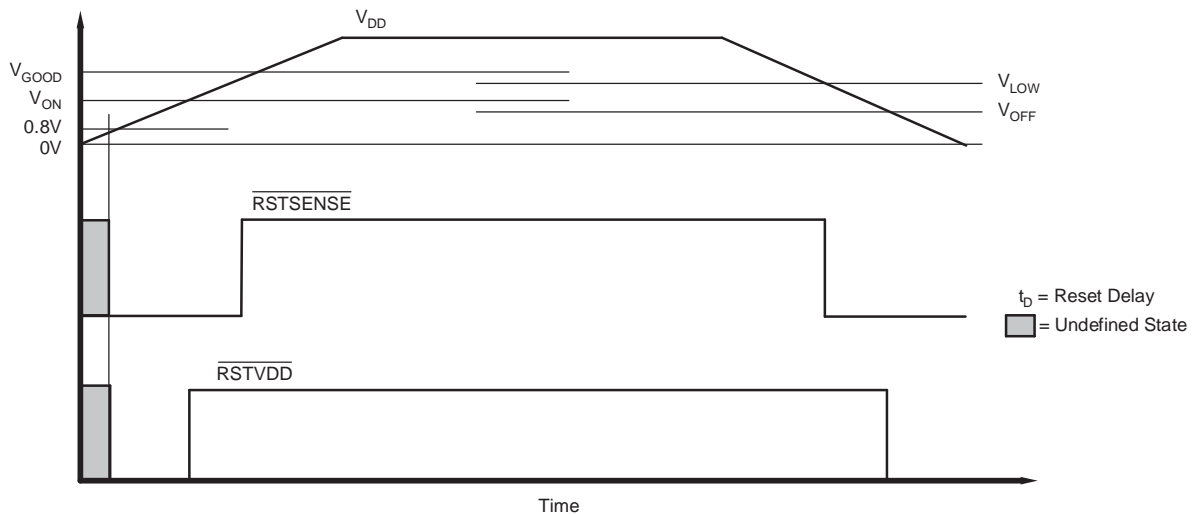

Figure 1. TPS3807 Timing Diagram Showing Reset Timing (SENSE resistor divider set to 3.6V)

### TYPICAL CHARACTERISTICS

At  $T_A = +25^\circ\text{C}$ ,  $V_{DD} = 3.3\text{V}$ ,  $R_{LRESET} = 1\text{M}\Omega$ , and  $C_{LRESET} = 50\text{pF}$ , unless otherwise noted.

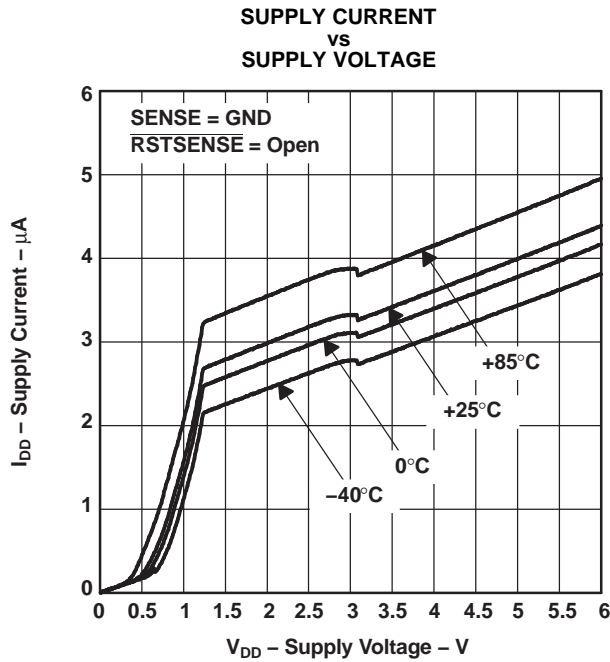

Figure 2.

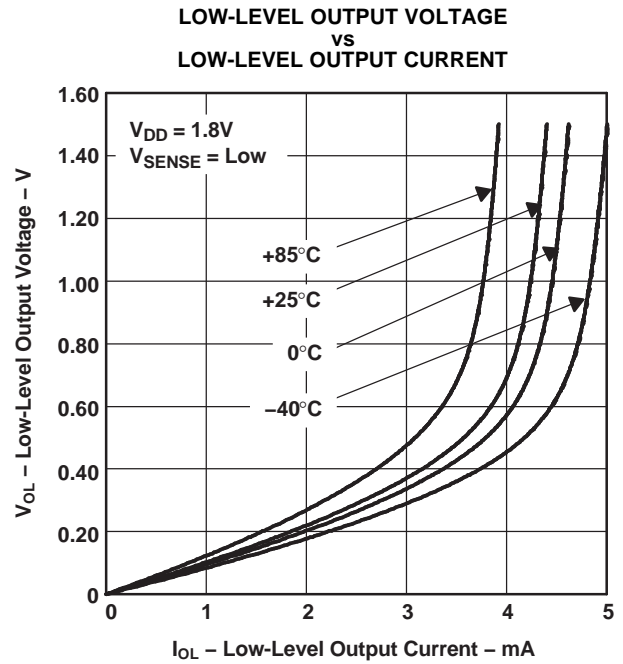

Figure 3.

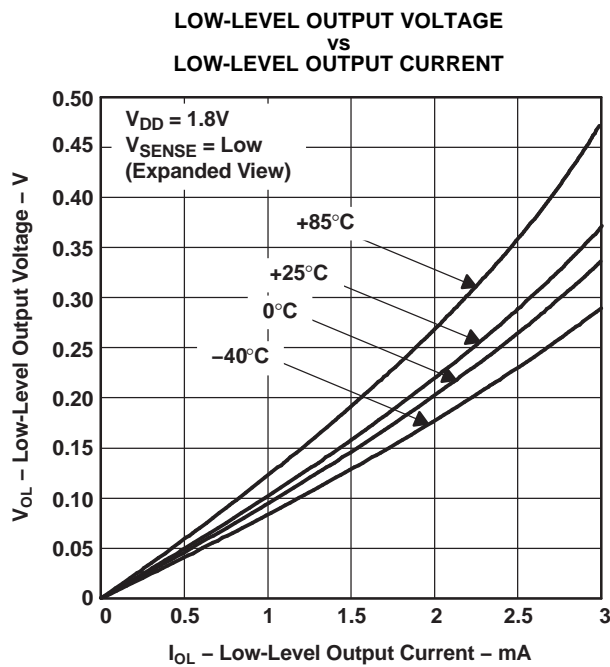

Figure 4.

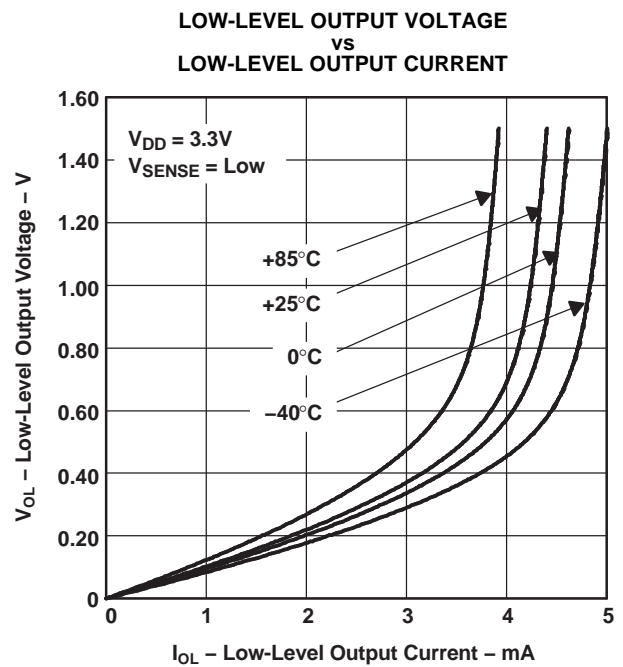

Figure 5.

**TYPICAL CHARACTERISTICS (continued)**

At  $T_A = +25^\circ\text{C}$ ,  $V_{DD} = 3.3\text{V}$ ,  $R_{LRESET} = 1\text{M}\Omega$ , and  $C_{LRESET} = 50\text{pF}$ , unless otherwise noted.

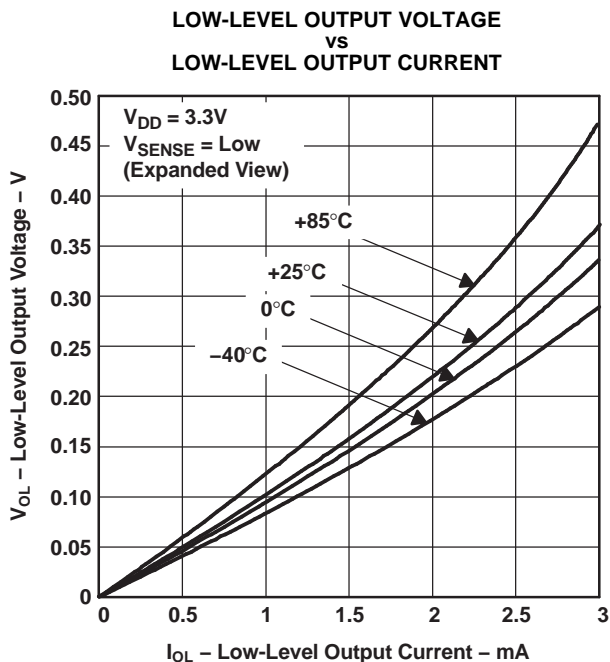

Figure 6.

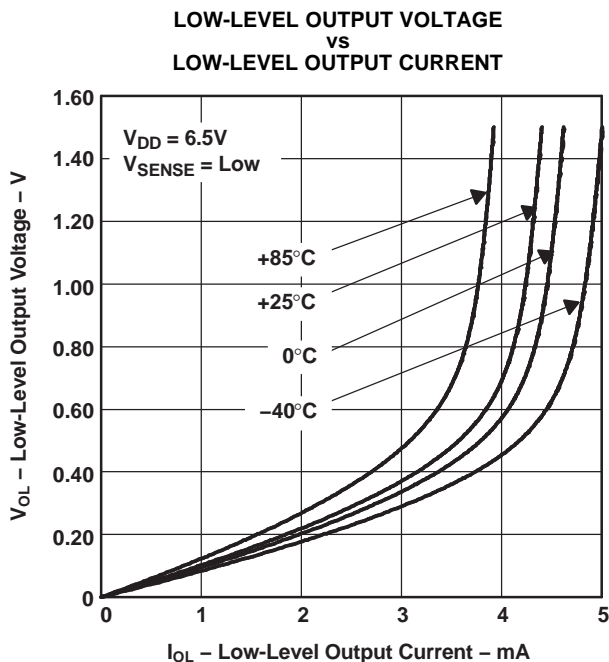

Figure 7.

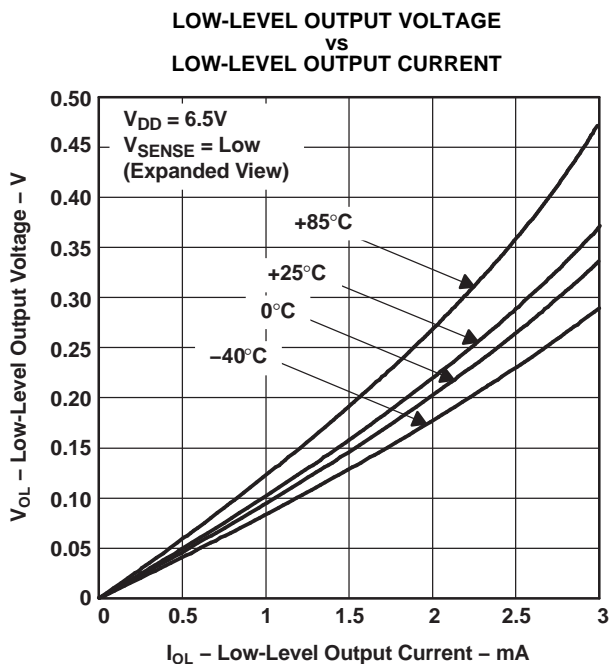

Figure 8.

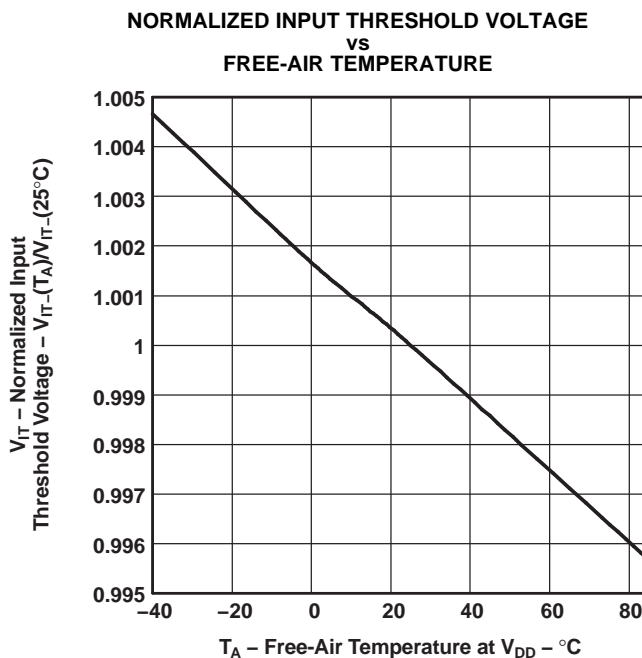

Figure 9.

**TYPICAL CHARACTERISTICS (continued)**

At  $T_A = +25^\circ\text{C}$ ,  $V_{DD} = 3.3\text{V}$ ,  $R_{LRESET} = 1\text{M}\Omega$ , and  $C_{LRESET} = 50\text{pF}$ , unless otherwise noted.

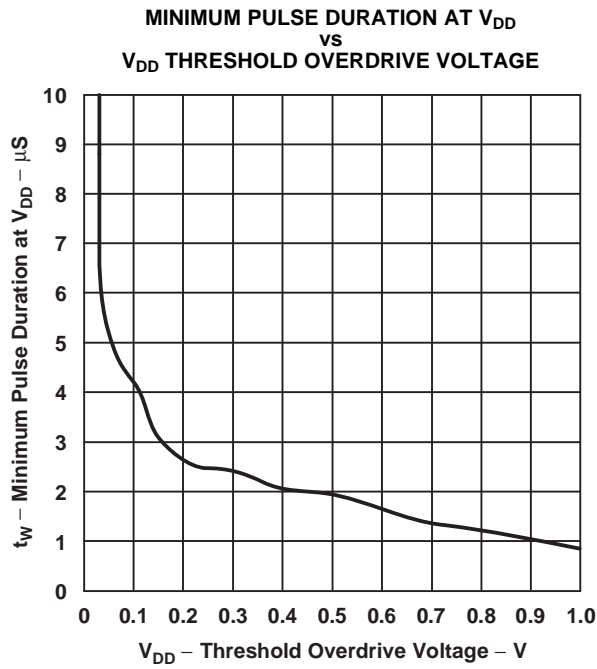

Figure 10.

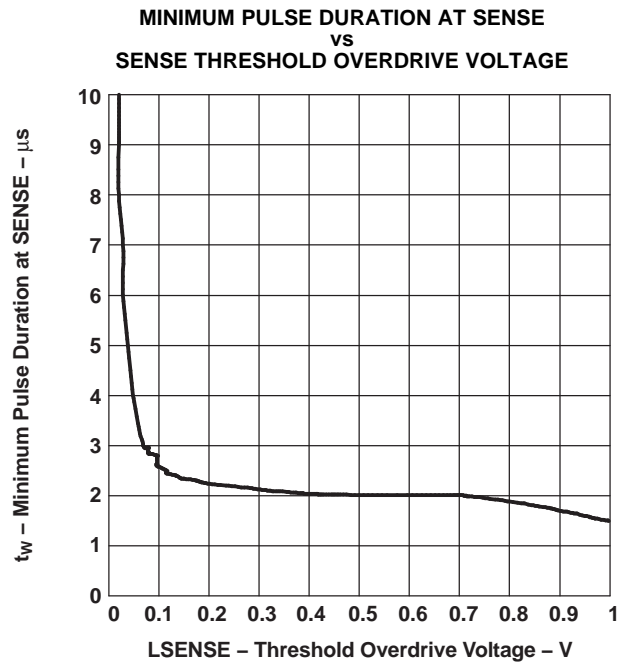

Figure 11.

**PACKAGING INFORMATION**

Orderable Device	Status <sup>(1)</sup>	Package Type	Package Drawing	Pins	Package Qty	Eco Plan <sup>(2)</sup>	Lead/Ball Finish	MSL Peak Temp <sup>(3)</sup>
TPS3807A30DCKR	ACTIVE	SC70	DCK	5	3000	Green (RoHS & no Sb/Br)	CU NIPDAU	Level-1-260C-UNLIM
TPS3807A30DCKRG4	ACTIVE	SC70	DCK	5	3000	Green (RoHS & no Sb/Br)	CU NIPDAU	Level-1-260C-UNLIM
TPS3807A30DCKT	ACTIVE	SC70	DCK	5	250	Green (RoHS & no Sb/Br)	CU NIPDAU	Level-1-260C-UNLIM
TPS3807A30DCKTG4	ACTIVE	SC70	DCK	5	250	Green (RoHS & no Sb/Br)	CU NIPDAU	Level-1-260C-UNLIM

<sup>(1)</sup> The marketing status values are defined as follows:

**ACTIVE:** Product device recommended for new designs.

**LIFEBUY:** TI has announced that the device will be discontinued, and a lifetime-buy period is in effect.

**NRND:** Not recommended for new designs. Device is in production to support existing customers, but TI does not recommend using this part in a new design.

**PREVIEW:** Device has been announced but is not in production. Samples may or may not be available.

**OBSOLETE:** TI has discontinued the production of the device.

<sup>(2)</sup> Eco Plan - The planned eco-friendly classification: Pb-Free (RoHS), Pb-Free (RoHS Exempt), or Green (RoHS & no Sb/Br) - please check <http://www.ti.com/productcontent> for the latest availability information and additional product content details.

**TBD:** The Pb-Free/Green conversion plan has not been defined.

**Pb-Free (RoHS):** TI's terms "Lead-Free" or "Pb-Free" mean semiconductor products that are compatible with the current RoHS requirements for all 6 substances, including the requirement that lead not exceed 0.1% by weight in homogeneous materials. Where designed to be soldered at high temperatures, TI Pb-Free products are suitable for use in specified lead-free processes.

**Pb-Free (RoHS Exempt):** This component has a RoHS exemption for either 1) lead-based flip-chip solder bumps used between the die and package, or 2) lead-based die adhesive used between the die and leadframe. The component is otherwise considered Pb-Free (RoHS compatible) as defined above.

**Green (RoHS & no Sb/Br):** TI defines "Green" to mean Pb-Free (RoHS compatible), and free of Bromine (Br) and Antimony (Sb) based flame retardants (Br or Sb do not exceed 0.1% by weight in homogeneous material)

<sup>(3)</sup> MSL, Peak Temp. -- The Moisture Sensitivity Level rating according to the JEDEC industry standard classifications, and peak solder temperature.

**Important Information and Disclaimer:**The information provided on this page represents TI's knowledge and belief as of the date that it is provided. TI bases its knowledge and belief on information provided by third parties, and makes no representation or warranty as to the accuracy of such information. Efforts are underway to better integrate information from third parties. TI has taken and continues to take reasonable steps to provide representative and accurate information but may not have conducted destructive testing or chemical analysis on incoming materials and chemicals. TI and TI suppliers consider certain information to be proprietary, and thus CAS numbers and other limited information may not be available for release.

In no event shall TI's liability arising out of such information exceed the total purchase price of the TI part(s) at issue in this document sold by TI to Customer on an annual basis.



## TAPE AND REEL INFORMATION



### QUADRANT ASSIGNMENTS FOR PIN 1 ORIENTATION IN TAPE



\*All dimensions are nominal

Device	Package Type	Package Drawing	Pins	SPQ	Reel Diameter (mm)	Reel Width W1 (mm)	A0 (mm)	B0 (mm)	K0 (mm)	P1 (mm)	W (mm)	Pin1 Quadrant
TPS3807A30DCKR	SC70	DCK	5	3000	180.0	8.4	2.25	2.4	1.22	4.0	8.0	Q3
TPS3807A30DCKT	SC70	DCK	5	250	180.0	8.4	2.25	2.4	1.22	4.0	8.0	Q3

**TAPE AND REEL BOX DIMENSIONS**

\*All dimensions are nominal

Device	Package Type	Package Drawing	Pins	SPQ	Length (mm)	Width (mm)	Height (mm)
TPS3807A30DCKR	SC70	DCK	5	3000	202.0	201.0	28.0
TPS3807A30DCKT	SC70	DCK	5	250	202.0	201.0	28.0

DCK (R-PDSO-G5)

PLASTIC SMALL-OUTLINE PACKAGE

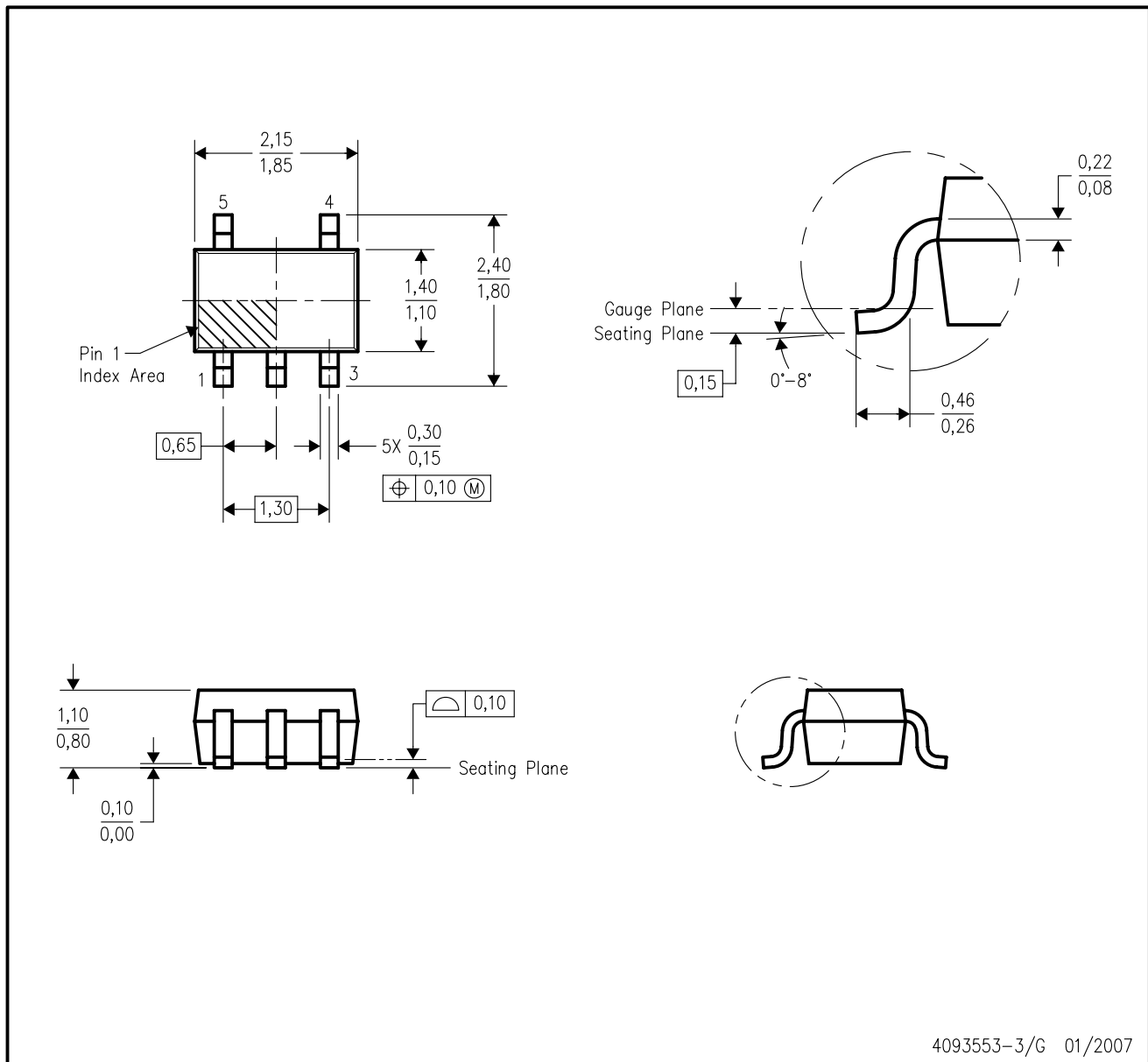

- NOTES:
- All linear dimensions are in millimeters.
  - This drawing is subject to change without notice.
  - Body dimensions do not include mold flash or protrusion. Mold flash and protrusion shall not exceed 0.15 per side.
  - Falls within JEDEC MO-203 variation AA.

DCK (R-PDSO-G5)

PLASTIC SMALL OUTLINE



- NOTES:
- All linear dimensions are in millimeters.
  - This drawing is subject to change without notice.
  - Customers should place a note on the circuit board fabrication drawing not to alter the center solder mask defined pad.
  - Publication IPC-7351 is recommended for alternate designs.
  - Laser cutting apertures with trapezoidal walls and also rounding corners will offer better paste release. Customers should contact their board assembly site for stencil design recommendations. Example stencil design based on a 50% volumetric metal load solder paste. Refer to IPC-7525 for other stencil recommendations.

## IMPORTANT NOTICE

Texas Instruments Incorporated and its subsidiaries (TI) reserve the right to make corrections, modifications, enhancements, improvements, and other changes to its products and services at any time and to discontinue any product or service without notice. Customers should obtain the latest relevant information before placing orders and should verify that such information is current and complete. All products are sold subject to TI's terms and conditions of sale supplied at the time of order acknowledgment.

TI warrants performance of its hardware products to the specifications applicable at the time of sale in accordance with TI's standard warranty. Testing and other quality control techniques are used to the extent TI deems necessary to support this warranty. Except where mandated by government requirements, testing of all parameters of each product is not necessarily performed.

TI assumes no liability for applications assistance or customer product design. Customers are responsible for their products and applications using TI components. To minimize the risks associated with customer products and applications, customers should provide adequate design and operating safeguards.

TI does not warrant or represent that any license, either express or implied, is granted under any TI patent right, copyright, mask work right, or other TI intellectual property right relating to any combination, machine, or process in which TI products or services are used. Information published by TI regarding third-party products or services does not constitute a license from TI to use such products or services or a warranty or endorsement thereof. Use of such information may require a license from a third party under the patents or other intellectual property of the third party, or a license from TI under the patents or other intellectual property of TI.

Reproduction of TI information in TI data books or data sheets is permissible only if reproduction is without alteration and is accompanied by all associated warranties, conditions, limitations, and notices. Reproduction of this information with alteration is an unfair and deceptive business practice. TI is not responsible or liable for such altered documentation. Information of third parties may be subject to additional restrictions.

Resale of TI products or services with statements different from or beyond the parameters stated by TI for that product or service voids all express and any implied warranties for the associated TI product or service and is an unfair and deceptive business practice. TI is not responsible or liable for any such statements.

TI products are not authorized for use in safety-critical applications (such as life support) where a failure of the TI product would reasonably be expected to cause severe personal injury or death, unless officers of the parties have executed an agreement specifically governing such use. Buyers represent that they have all necessary expertise in the safety and regulatory ramifications of their applications, and acknowledge and agree that they are solely responsible for all legal, regulatory and safety-related requirements concerning their products and any use of TI products in such safety-critical applications, notwithstanding any applications-related information or support that may be provided by TI. Further, Buyers must fully indemnify TI and its representatives against any damages arising out of the use of TI products in such safety-critical applications.

TI products are neither designed nor intended for use in military/aerospace applications or environments unless the TI products are specifically designated by TI as military-grade or "enhanced plastic." Only products designated by TI as military-grade meet military specifications. Buyers acknowledge and agree that any such use of TI products which TI has not designated as military-grade is solely at the Buyer's risk, and that they are solely responsible for compliance with all legal and regulatory requirements in connection with such use.

TI products are neither designed nor intended for use in automotive applications or environments unless the specific TI products are designated by TI as compliant with ISO/TS 16949 requirements. Buyers acknowledge and agree that, if they use any non-designated products in automotive applications, TI will not be responsible for any failure to meet such requirements.

Following are URLs where you can obtain information on other Texas Instruments products and application solutions:

### Products

Audio	<a href="http://www.ti.com/audio">www.ti.com/audio</a>
Amplifiers	<a href="http://amplifier.ti.com">amplifier.ti.com</a>
Data Converters	<a href="http://dataconverter.ti.com">dataconverter.ti.com</a>
DLP® Products	<a href="http://www.dlp.com">www.dlp.com</a>
DSP	<a href="http://dsp.ti.com">dsp.ti.com</a>
Clocks and Timers	<a href="http://www.ti.com/clocks">www.ti.com/clocks</a>
Interface	<a href="http://interface.ti.com">interface.ti.com</a>
Logic	<a href="http://logic.ti.com">logic.ti.com</a>
Power Mgmt	<a href="http://power.ti.com">power.ti.com</a>
Microcontrollers	<a href="http://microcontroller.ti.com">microcontroller.ti.com</a>
RFID	<a href="http://www.ti-rfid.com">www.ti-rfid.com</a>
RF/IF and ZigBee® Solutions	<a href="http://www.ti.com/lprf">www.ti.com/lprf</a>

### Applications

Communications and Telecom	<a href="http://www.ti.com/communications">www.ti.com/communications</a>
Computers and Peripherals	<a href="http://www.ti.com/computers">www.ti.com/computers</a>
Consumer Electronics	<a href="http://www.ti.com/consumer-apps">www.ti.com/consumer-apps</a>
Energy and Lighting	<a href="http://www.ti.com/energy">www.ti.com/energy</a>
Industrial	<a href="http://www.ti.com/industrial">www.ti.com/industrial</a>
Medical	<a href="http://www.ti.com/medical">www.ti.com/medical</a>
Security	<a href="http://www.ti.com/security">www.ti.com/security</a>
Space, Avionics and Defense	<a href="http://www.ti.com/space-avionics-defense">www.ti.com/space-avionics-defense</a>
Transportation and Automotive	<a href="http://www.ti.com/automotive">www.ti.com/automotive</a>
Video and Imaging	<a href="http://www.ti.com/video">www.ti.com/video</a>
Wireless	<a href="http://www.ti.com/wireless-apps">www.ti.com/wireless-apps</a>

TI E2E Community Home Page

[e2e.ti.com](http://e2e.ti.com)

Mailing Address: Texas Instruments, Post Office Box 655303, Dallas, Texas 75265  
Copyright © 2011, Texas Instruments Incorporated