

Ultra-Small, Low on Resistance Load Switch with Controlled Turn-on

Check for Samples: [TPS22910](#)

FEATURES

- Integrated Single Load Switch
- Ultra Small CSP-4 Package 0.9mm × 0.9mm, 0.5mm Pitch
- Input Voltage Range: 1.4-V to 5.5-V
- Low ON-Resistance
 - $r_{ON} = 60\text{-m}\Omega$ at $V_{IN} = 5\text{-V}$
 - $r_{ON} = 61\text{-m}\Omega$ at $V_{IN} = 3.3\text{-V}$
 - $r_{ON} = 74\text{-m}\Omega$ at $V_{IN} = 1.8\text{-V}$
 - $r_{ON} = 84\text{-m}\Omega$ at $V_{IN} = 1.5\text{-V}$
- 2-A Maximum Continuous Switch Current
- Low Threshold Control Input
- Controlled Slew-rate Options
- Under-Voltage Lock Out
- Reverse Current Protection

APPLICATIONS

- Portable Industrial / Medical Equipment
- Portable Media Players
- Point Of Sales Terminals
- GPS Navigation Devices
- Digital Cameras
- Portable Instrumentation
- Smartphones / Wireless Handsets

DESCRIPTION

The TPS22910 is a small, low r_{ON} load switch with controlled turn on. The device contains a P-channel MOSFET that can operate over an input voltage range of 1.4 V to 5.5 V. The switch is controlled by an on/off input (ON), which is capable of interfacing directly with low-voltage control signals. The TPS22910 is active low enable.

The slew rate of the device is internally controlled in order to avoid inrush current. The TPS22910 family has various rise time options (see [Table 1](#)).

The TPS22910 device provides circuit breaker functionality by latching off the power-switch during reverse voltage situations. An internal reverse voltage comparator disables the power-switch when the output voltage (V_{OUT}) is driven higher than the input (V_{IN}) to quickly ($10\mu\text{s}$ typ) stop the flow of current towards the input side of the switch. Reverse current protection is always active, even when the power-switch is disabled. Additionally, under-voltage lockout (UVLO) protection turns the switch off if the input voltage is too low.

The TPS22910 is available in an ultra-small, space-saving 4-pin CSP package and is characterized for operation over the free-air temperature range of -40°C to 85°C .

TYPICAL APPLICATION

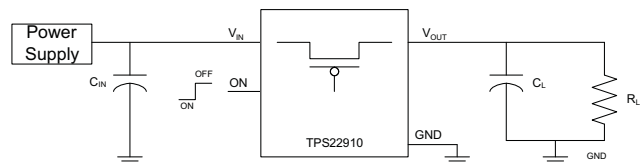
Table 1. Feature List

DEVICE	r_{ON} (typ) at 3.3 V	RISE TIME at 3.3V (typ)	QUICK OUTPUT DISCHARGE ⁽¹⁾	MAXIMUM OUTPUT CURRENT	ENABLE
TPS22910A	63 m Ω	1 μs	No	2-A	Active Low
TPS22910B ⁽²⁾	63 m Ω	100 μs	No	2-A	Active Low
TPS22910C ⁽²⁾	63 m Ω	1000 μs	No	2-A	Active Low
TPS22910D ⁽²⁾	63 m Ω	4500 μs	No	2-A	Active Low

(1) This feature discharges the output of the switch to ground through an 150- Ω resistor, preventing the output from floating.

(2) Contact local sales/distributor or factory for availability.



Please be aware that an important notice concerning availability, standard warranty, and use in critical applications of Texas Instruments semiconductor products and disclaimers thereto appears at the end of this data sheet.

TPS22910

SLVSB49B – NOVEMBER 2011 – REVISED APRIL 2012

www.ti.com



These devices have limited built-in ESD protection. The leads should be shorted together or the device placed in conductive foam during storage or handling to prevent electrostatic damage to the MOS gates.

ORDERING INFORMATION

T _A	PACKAGE ⁽¹⁾		ORDERABLE PART NUMBER	TOP-SIDE MARKING/ STATUS ⁽²⁾
-40°C to 85°C	YZV (0.5mm pitch)	Tape and Reel	TPS22910AYZVR	____ 75
-40°C to 85°C	YZV (0.5mm pitch)	Tape and Reel	TPS22910BYZVR	Contact factory for availability
-40°C to 85°C	YZV (0.5mm pitch)	Tape and Reel	TPS22910CYZVR	Contact factory for availability
-40°C to 85°C	YZV (0.5mm pitch)	Tape and Reel	TPS22910DYZVR	Contact factory for availability

- (1) Package drawings, standard packing quantities, thermal data, symbolization, and PCB design guidelines are available at www.ti.com/sc/package.
 (2) Contact factory for details and availability for PREVIEW devices, minimum order quantities may apply.

DEVICE INFORMATION

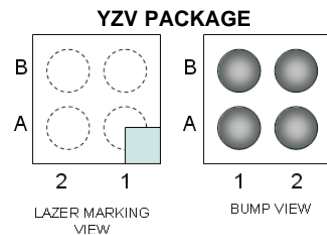

TERMINAL ASSIGNMENTS

B	ON	GND
A	V _{IN}	V _{OUT}
	2	1

PIN FUNCTIONS

TPS22910	PIN NAME	DESCRIPTION
YZV		
B1	GND	Ground
B2	ON	Switch control input, active low. Do not leave floating
A1	V _{OUT}	Switch output
A2	V _{IN}	Switch input, bypass this input with a ceramic capacitor to ground

BLOCK DIAGRAM

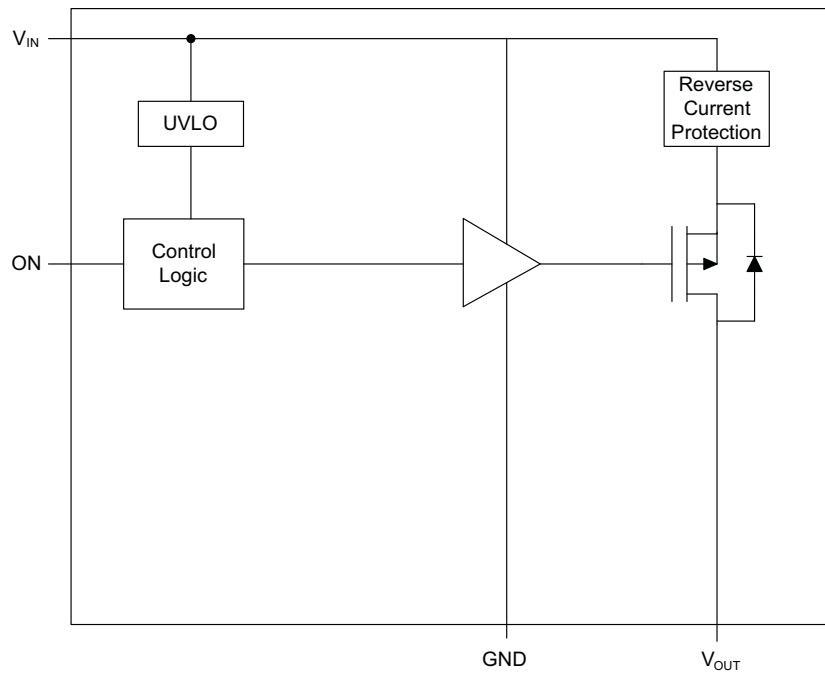

Table 2. FUNCTION TABLE

ON	VIN to VOUT
L	ON
H	OFF

ABSOLUTE MAXIMUM RATINGS

		VALUE	UNIT	
V _{IN}	Input voltage range	-0.3 to 6	V	
V _{OUT}	Output voltage range	-0.3 to 6	V	
V _{ON}	Input voltage range	-0.3 to 6	V	
I _{MAX}	Maximum continuous switch current	2	A	
I _{PLS}	Maximum pulsed switch current, pulse <300 μS, 2% duty cycle	2.5	A	
T _A	Operating free-air temperature range	-40 to 85	°C	
T _J	Maximum junction temperature	125	°C	
T _{STG}	Storage temperature range	-65 to 150	°C	
T _{LEAD}	Maximum lead temperature (10-s soldering time)	300	°C	
ESD	Electrostatic discharge protection	Human-Body Model (HBM) (VIN, VOUT, GND pins)	2000	V
		Charged-Device Model (CDM) (VIN, VOUT, ON, GND pins)	1000	

THERMAL INFORMATION

THERMAL METRIC ⁽¹⁾		TPS22910		UNITS
		CSP		
		(4) PINS		
θ_{JA}	Junction-to-ambient thermal resistance	189.1		°C/W
θ_{JCTop}	Junction-to-case (top) thermal resistance	1.9		
θ_{JB}	Junction-to-board thermal resistance	36.8		
ψ_{JT}	Junction-to-top characterization parameter	11.3		
ψ_{JB}	Junction-to-board characterization parameter	36.8		
θ_{JCbott}	Junction-to-case (bottom) thermal resistance	N/A		

(1) For more information about traditional and new thermal metrics, see the *IC Package Thermal Metrics* application report, [SPRA953](#).

RECOMMENDED OPERATING CONDITIONS

			MIN	MAX	UNIT
V_{IN}	Input voltage range		1.4	5.5	V
V_{ON}	ON voltage range		0	5.5	V
V_{OUT}	Output voltage range			V_{IN}	
V_{IH}	High-level input voltage, ON	$V_{IN} = 3.61 \text{ V to } 5.5 \text{ V}$	1.1	5.5	V
		$V_{IN} = 1.4 \text{ V to } 3.6 \text{ V}$	1.1	5.5	V
V_{IL}	Low-level input voltage, ON	$V_{IN} = 3.61 \text{ V to } 5.5 \text{ V}$		0.6	V
		$V_{IN} = 1.4 \text{ V to } 3.6 \text{ V}$		0.4	V
C_{IN}	Input Capacitor		1 ⁽¹⁾		μF

(1) Refer to the application section.

ELECTRICAL CHARACTERISTICS
 $V_{IN} = 1.4\text{ V to } 5.5\text{ V}$, $T_A = -40^\circ\text{C to } 85^\circ\text{C}$ (unless otherwise noted)

PARAMETER		TEST CONDITIONS	T_A	MIN	TYP	MAX	UNIT
I_{IN}	Quiescent current	$I_{OUT} = 0$, $V_{IN} = 5.25\text{ V}$, $V_{ON} = 0\text{ V}$	Full		2	10	μA
		$I_{OUT} = 0$, $V_{IN} = 4.2\text{ V}$, $V_{ON} = 0\text{ V}$			2	7.0	
		$I_{OUT} = 0$, $V_{IN} = 3.6\text{ V}$, $V_{ON} = 0\text{ V}$			2	7.0	
		$I_{OUT} = 0$, $V_{IN} = 2.5\text{ V}$, $V_{ON} = 0\text{ V}$			0.9	5	
		$I_{OUT} = 0$, $V_{IN} = 1.5\text{ V}$, $V_{ON} = 0\text{ V}$			0.7	5	
$I_{IN(off)}$	Off supply current	$V_{OUT} = \text{Open}$, $V_{IN} = V_{ON} = 5.25\text{ V}$	Full		1.2	10	μA
		$V_{OUT} = \text{Open}$, $V_{IN} = V_{ON} = 4.2\text{ V}$			0.2	7.0	
		$V_{OUT} = \text{Open}$, $V_{IN} = V_{ON} = 3.6\text{ V}$			0.1	7.0	
		$V_{OUT} = \text{Open}$, $V_{IN} = V_{ON} = 2.5\text{ V}$			0.1	5	
		$V_{OUT} = \text{Open}$, $V_{IN} = V_{ON} = 1.5\text{ V}$			0.1	5	
$I_{IN(Leakage)}$	Leakage current	$V_{OUT} = 0\text{ V}$, $V_{IN} = V_{ON} = 5.25\text{ V}$	Full		1.2	10	μA
		$V_{OUT} = 0\text{ V}$, $V_{IN} = V_{ON} = 4.2\text{ V}$			0.2	7.0	
		$V_{OUT} = 0\text{ V}$, $V_{IN} = V_{ON} = 3.6\text{ V}$			0.1	7.0	
		$V_{OUT} = 0\text{ V}$, $V_{IN} = V_{ON} = 2.5\text{ V}$			0.1	5	
		$V_{OUT} = 0\text{ V}$, $V_{IN} = V_{ON} = 1.5\text{ V}$			0.1	5	
r_{ON}	On-resistance	$V_{IN} = 5.25\text{ V}$, $I_{OUT} = -200\text{ mA}$	25°C		60	80	$\text{m}\Omega$
			Full			110	
		$V_{IN} = 5.0\text{ V}$, $I_{OUT} = -200\text{ mA}$	25°C		60	80	
			Full			110	
		$V_{IN} = 4.2\text{ V}$, $I_{OUT} = -200\text{ mA}$	25°C		60	80	
			Full			110	
		$V_{IN} = 3.3\text{ V}$, $I_{OUT} = -200\text{ mA}$	25°C		60.7	80	
			Full			110	
		$V_{IN} = 2.5\text{ V}$, $I_{OUT} = -200\text{ mA}$	25°C		63.4	90	
			Full			120	
		$V_{IN} = 1.8\text{ V}$, $I_{OUT} = -200\text{ mA}$	25°C		74.2	100	
			Full			130	
		$V_{IN} = 1.5\text{ V}$, $I_{OUT} = -200\text{ mA}$	25°C		83.9	120	
			Full			150	
UVLO	Under voltage lockout	V_{IN} increasing, $V_{ON} = 0\text{ V}$, $I_{OUT} = -100\text{ mA}$	Full			1.2	V
					0.50		
I_{ON}	ON input leakage current	$V_{ON} = 1.4\text{ V to } 5.25\text{ V or GND}$	Full			1	μA
V_{RVP}	Reverse Current Voltage Threshold				44		mV
t_{DELAY}	Reverse Current Response Delay	$V_{IN} = 5\text{ V}$			10		μs

TPS22910

SLVSB49B – NOVEMBER 2011 – REVISED APRIL 2012

www.ti.com

SWITCHING CHARACTERISTICS

PARAMETER	TEST CONDITION	TPS22910A	UNIT
		TYP	
V_{IN} = 5 V, T_A = 25°C (unless otherwise noted)			
t _{ON} Turn-ON time	R _L = 10 Ω, C _L = 0.1 μF	2	μs
t _{OFF} Turn-OFF time	R _L = 10 Ω, C _L = 0.1 μF	5.5	
t _R VOUT rise time	R _L = 10 Ω, C _L = 0.1 μF	1	
t _F VOUT fall time	R _L = 10 Ω, C _L = 0.1 μF	3	
V_{IN} = 3.3 V, T_A = 25°C (unless otherwise noted)			
t _{ON} Turn-ON time	R _L = 10 Ω, C _L = 0.1 μF	2.5	μs
t _{OFF} Turn-OFF time	R _L = 10 Ω, C _L = 0.1 μF	7	
t _R VOUT rise time	R _L = 10 Ω, C _L = 0.1 μF	1	
t _F VOUT fall time	R _L = 10 Ω, C _L = 0.1 μF	3.5	
V_{IN} = 1.5 V, T_A = 25°C (unless otherwise noted)			
t _{ON} Turn-ON time	R _L = 10 Ω, C _L = 0.1 μF	4.5	μs
t _{OFF} Turn-OFF time	R _L = 10 Ω, C _L = 0.1 μF	16.5	
t _R VOUT rise time	R _L = 10 Ω, C _L = 0.1 μF	2	
t _F VOUT fall time	R _L = 10 Ω, C _L = 0.1 μF	7	

PARAMETRIC MEASUREMENT INFORMATION

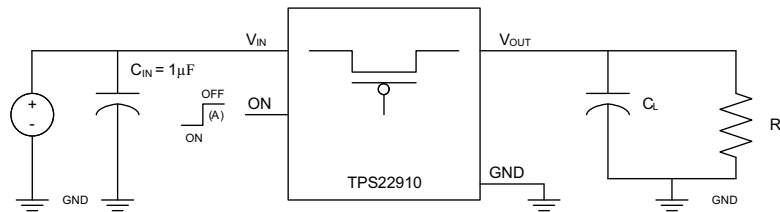

TEST CIRCUIT

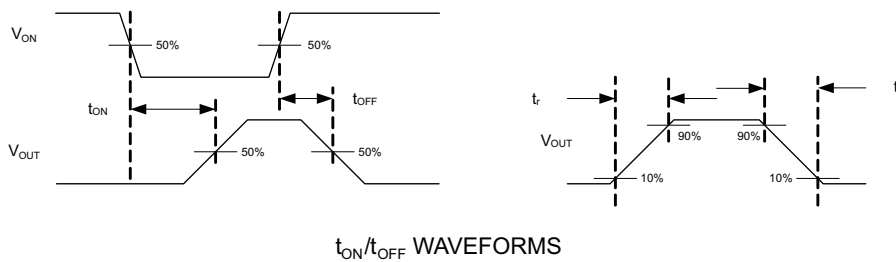

t_{ON}/t_{OFF} WAVEFORMS

(A) Rise and fall times of the control signal is 100ns.

- A. Rise and fall times of the control signal is 100 ns.

Figure 1. Test Circuit and t_{ON}/t_{OFF} Waveforms

TYPICAL CHARACTERISTICS

ON-STATE RESISTANCE
vs
INPUT VOLTAGE

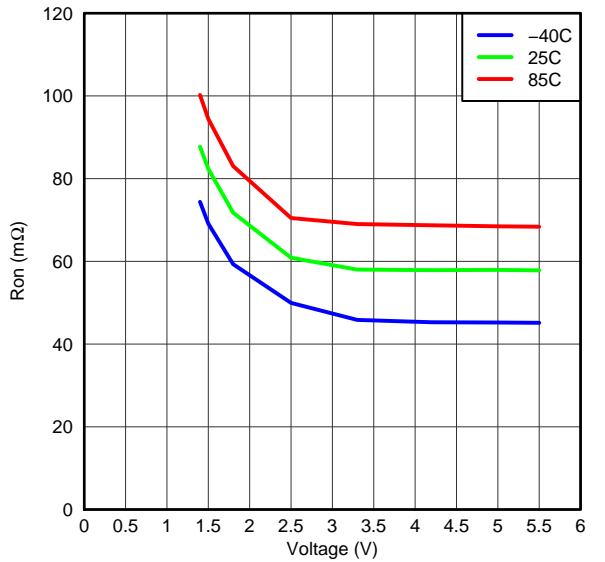

Figure 2.

ON INPUT THRESHOLD

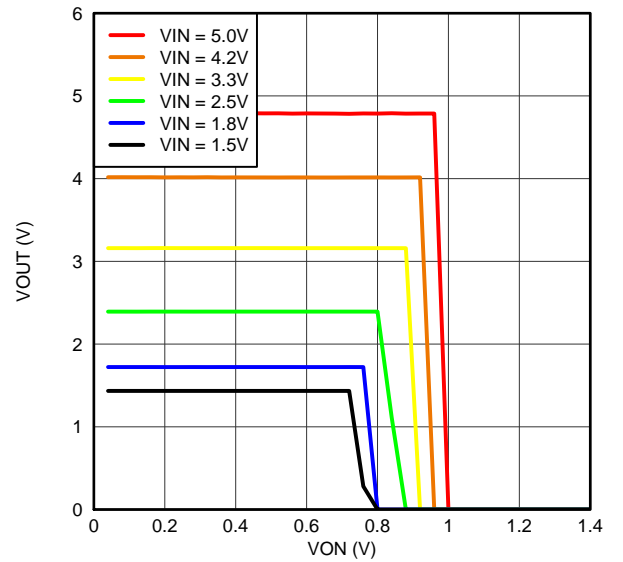

Figure 3.

INPUT CURRENT, QUIESCENT
vs
INPUT VOLTAGE

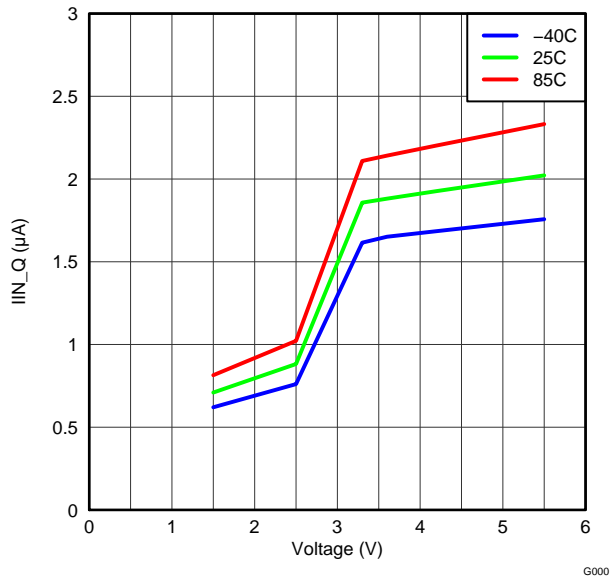

Figure 4.

INPUT CURRENT, LEAK
vs
INPUT VOLTAGE

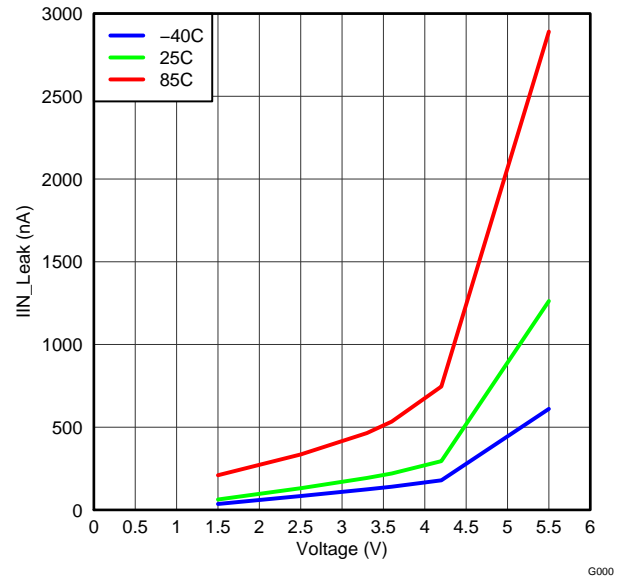

Figure 5.

TYPICAL CHARACTERISTICS (continued)

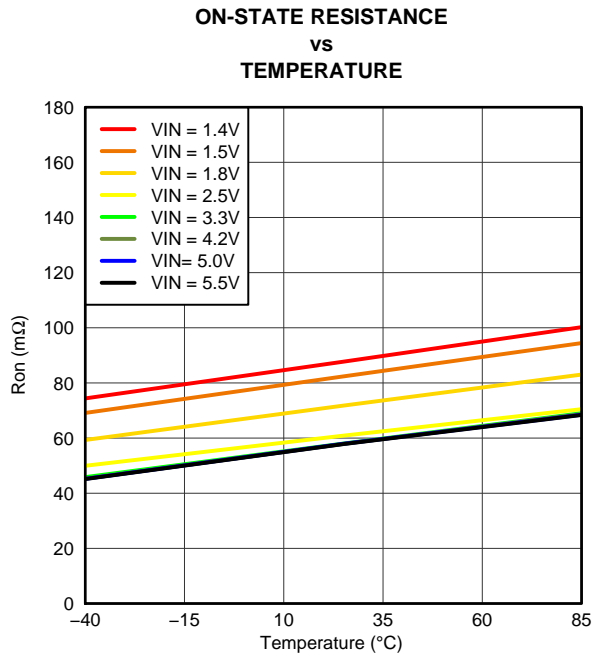

Figure 6.

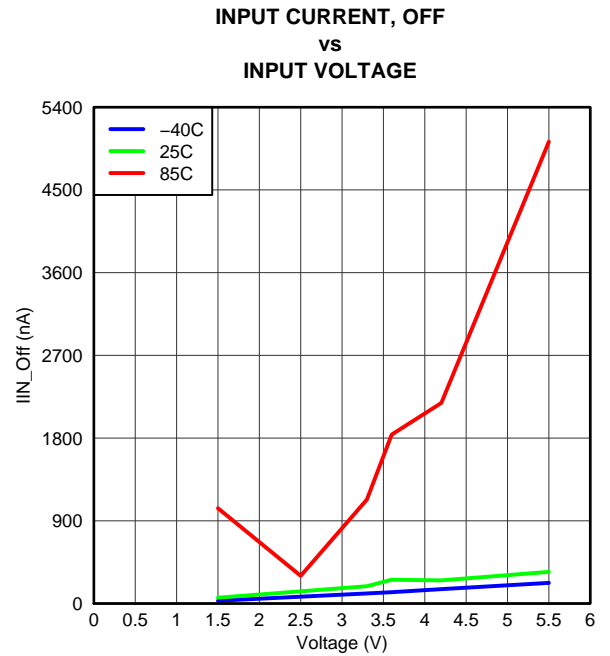

Figure 7.

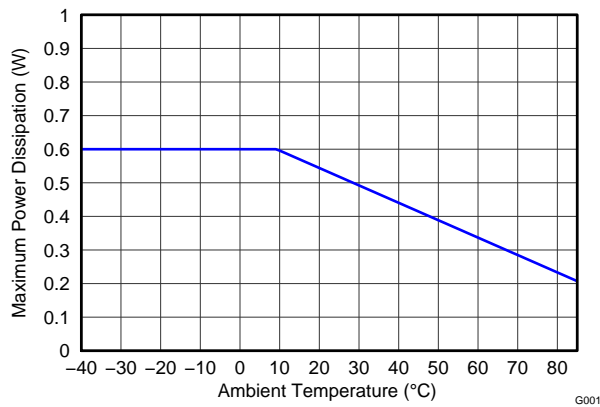

Figure 8. Allowable Power Dissipation

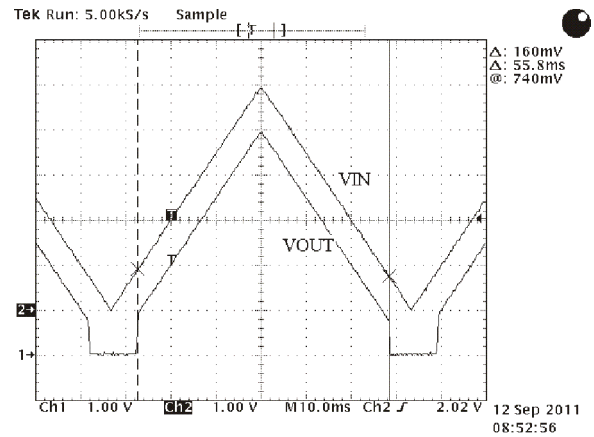

Figure 9. ULVO Response $I_{OUT} = -100\text{mA}$

TYPICAL CHARACTERISTICS (continued)

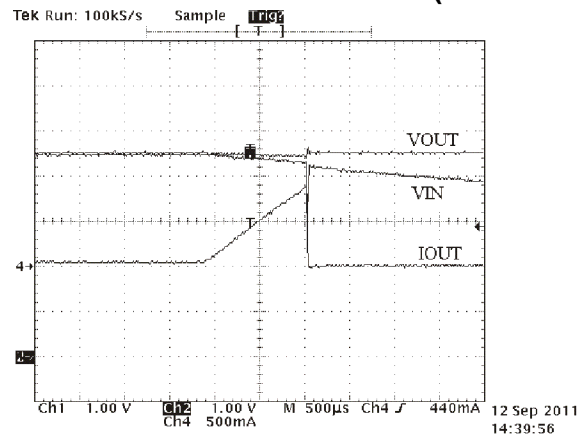

Figure 10. Reverse Current Protection $V_{OUT} = 3.3V$, $V_{IN} = 3.3V$ Decreasing to 0V

TYPICAL AC CHARACTERISTICS FOR TPS22910A

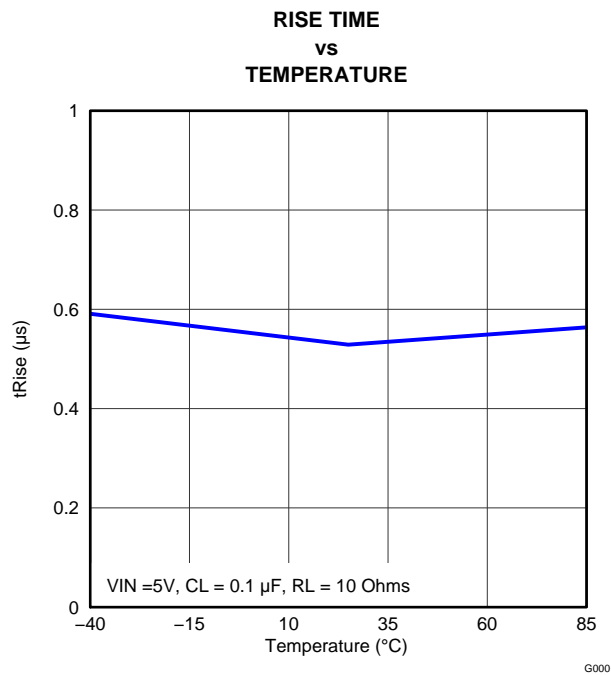

Figure 11.

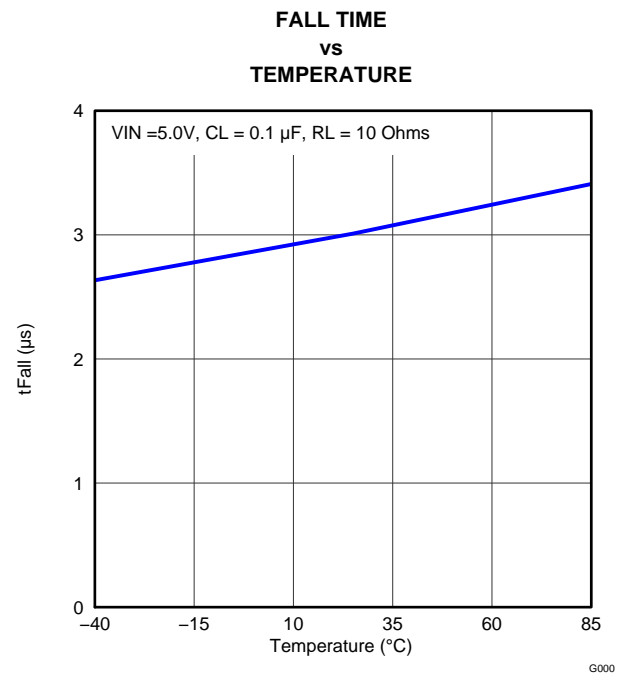

Figure 12.

TYPICAL CHARACTERISTICS (continued)

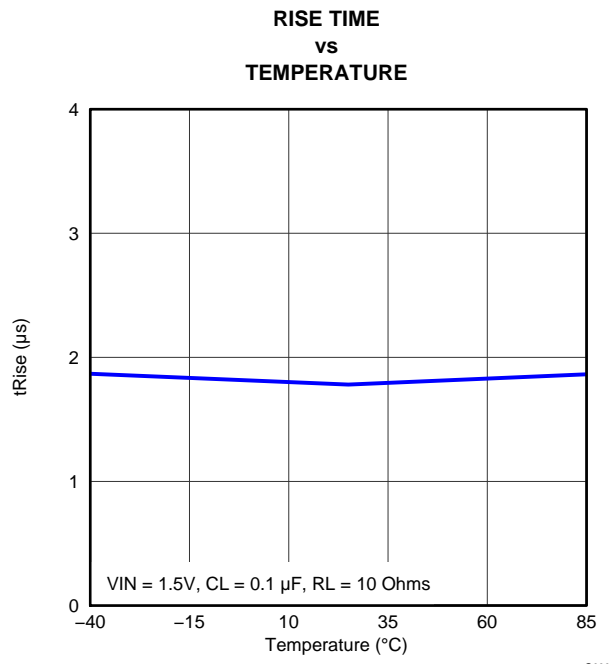

Figure 13.

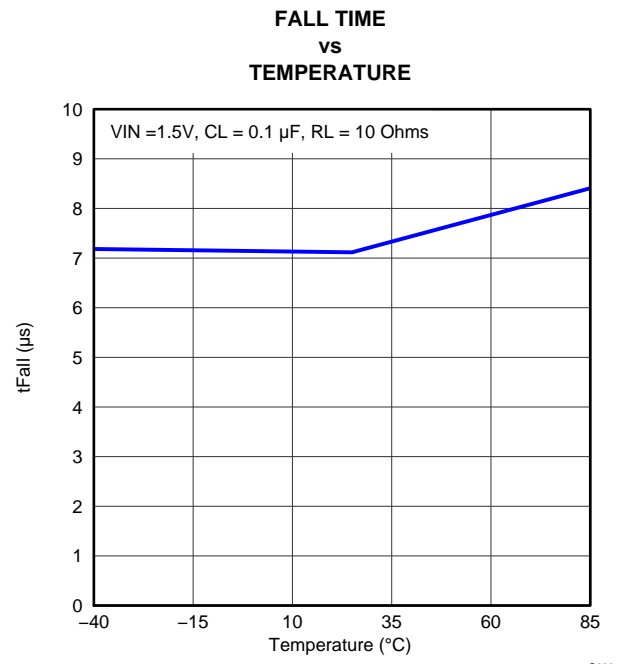

Figure 14.

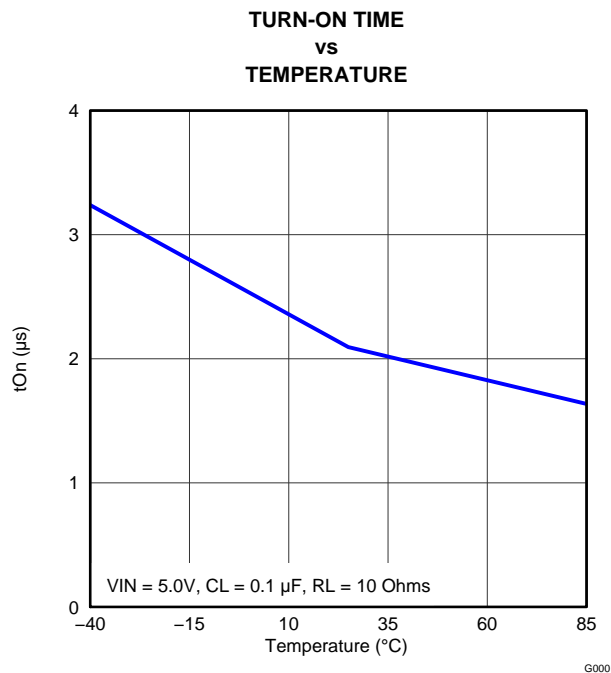

Figure 15.

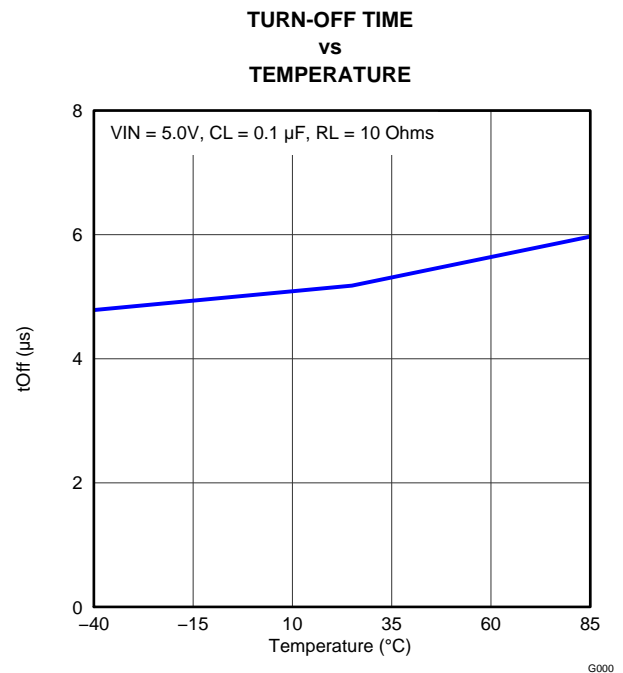

Figure 16.

TYPICAL CHARACTERISTICS (continued)

TURN-ON TIME
vs
TEMPERATURE

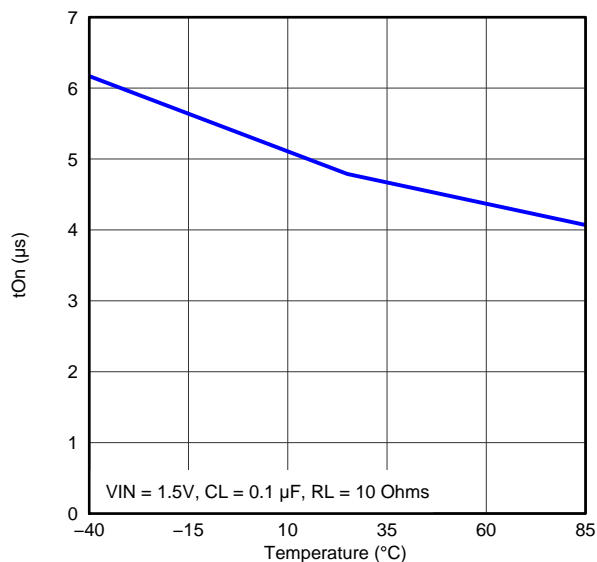

Figure 17.

TURN-OFF TIME
vs
TEMPERATURE

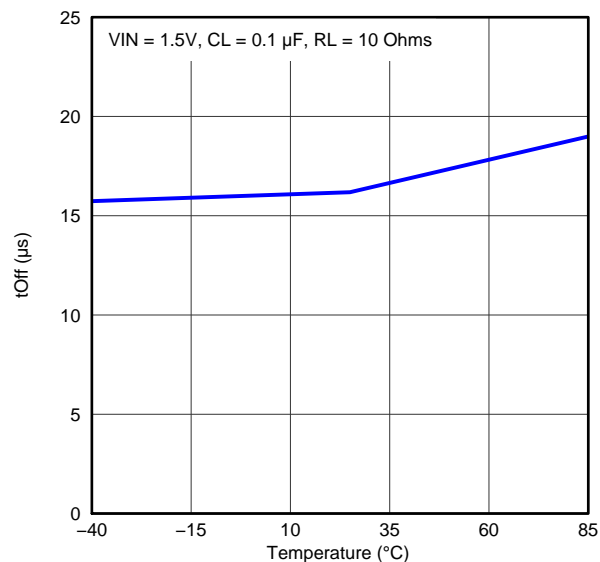

Figure 18.

RISE TIME
vs
INPUT VOLTAGE

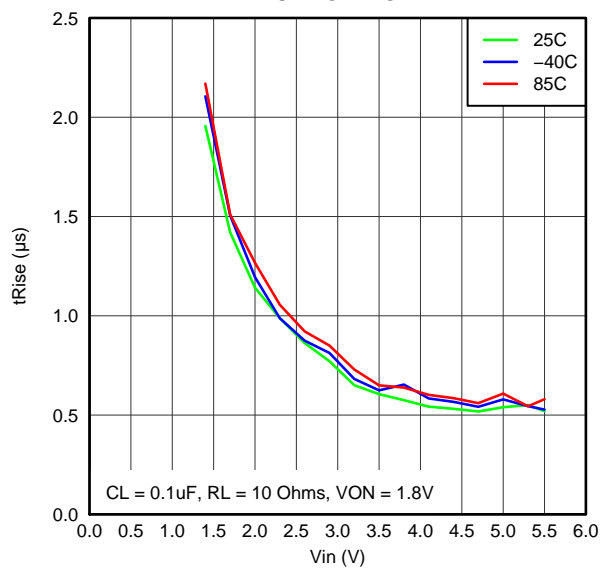

Figure 19.

TYPICAL CHARACTERISTICS (continued)

TURN-ON RESPONSE

$V_{IN} = 5V, T_A = 25^\circ C, C_{IN} = 10\mu F, C_L = 0.1\mu F, R_L = 10\Omega$

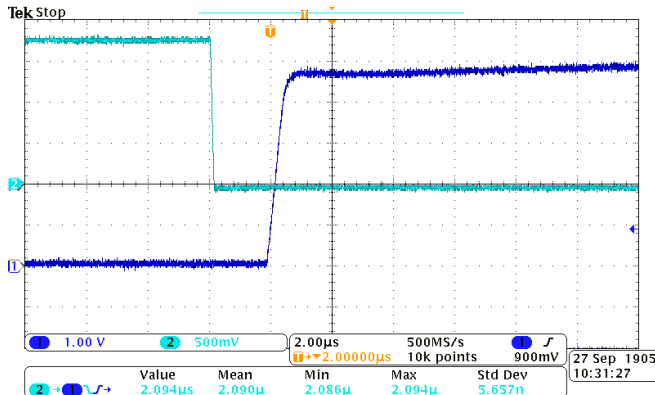

Figure 20.

TURN-OFF RESPONSE

$V_{IN} = 5V, T_A = 25^\circ C, C_{IN} = 10\mu F, C_L = 0.1\mu F, R_L = 10\Omega$

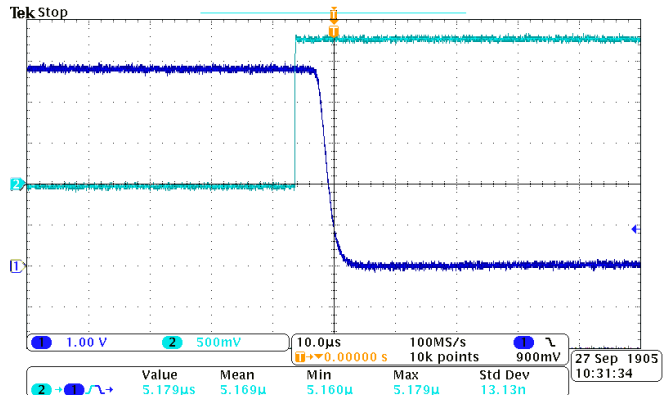

Figure 21.

TURN-ON RESPONSE TIME

$V_{IN} = 5V, T_A = 25^\circ C, C_{IN} = 10\mu F, C_L = 1\mu F, R_L = 10\Omega$

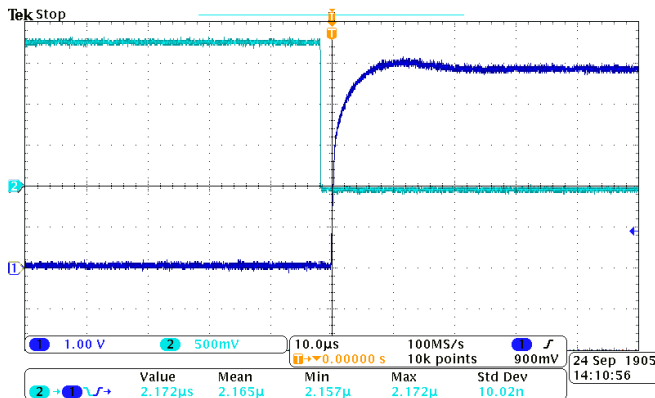

Figure 22.

TURN-OFF RESPONSE TIME

$V_{IN} = 5V, T_A = 25^\circ C, C_{IN} = 10\mu F, C_L = 1\mu F, R_L = 10\Omega$

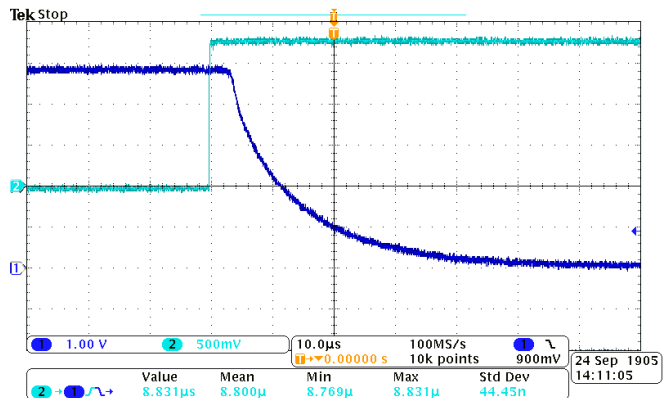

Figure 23.

TURN-ON RESPONSE TIME

$V_{IN} = 1.5V, T_A = 25^\circ C, C_{IN} = 10\mu F, C_L = 0.1\mu F, R_L = 10\Omega$

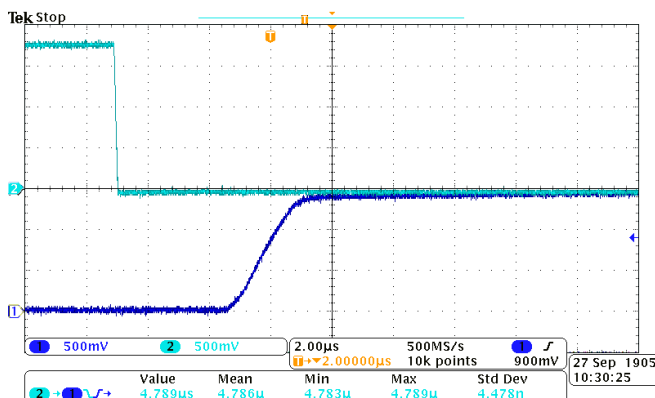

Figure 24.

TURN-OFF RESPONSE TIME

$V_{IN} = 1.5V, T_A = 25^\circ C, C_{IN} = 10\mu F, C_L = 0.1\mu F, R_L = 10\Omega$

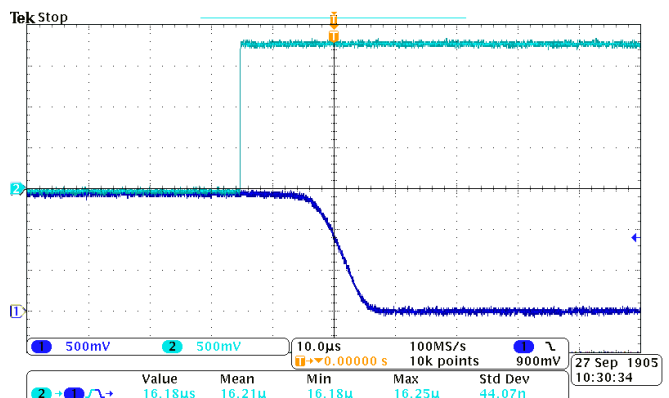

Figure 25.

TYPICAL CHARACTERISTICS (continued)

TURN-ON RESPONSE TIME

$V_{IN} = 1.5V$, $T_A = 25^\circ C$, $C_{IN} = 10\mu F$, $C_L = 1\mu F$, $R_L = 10\Omega$

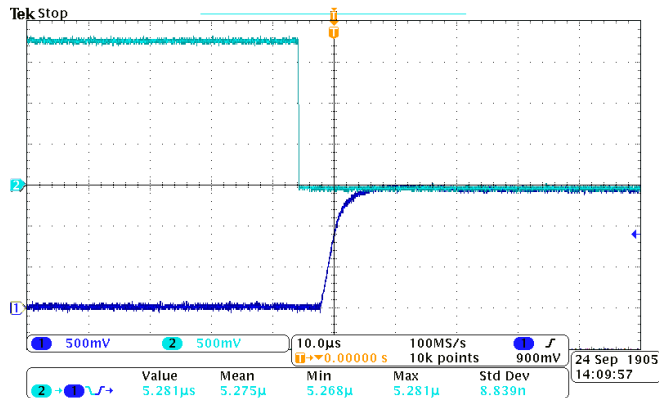

Figure 26.

TURN-OFF RESPONSE TIME

$V_{IN} = 1.5V$, $T_A = 25^\circ C$, $C_{IN} = 10\mu F$, $C_L = 1\mu F$, $R_L = 10\Omega$

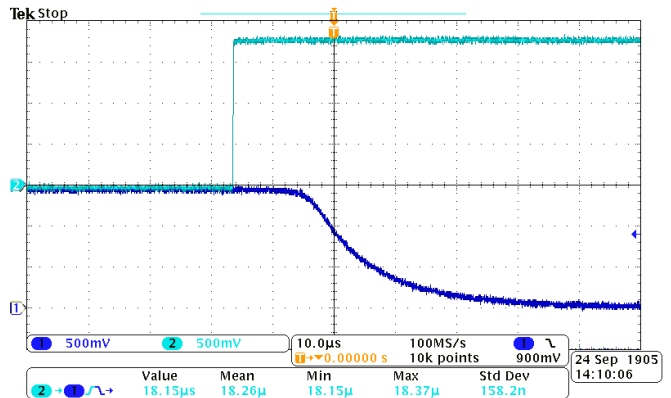

Figure 27.

APPLICATION INFORMATION

On/Off Control

The ON pin controls the state of the switch. Asserting ON low enables the switch. ON is active low and has a low threshold, making it capable of interfacing with low-voltage signals. The ON pin is compatible with standard GPIO logic threshold. It can be used with any microcontroller with 1.2-V, 1.8-V, 2.5-V or 3.3-V GPIO.

Input Capacitor

To limit the voltage drop on the input supply caused by transient inrush currents, when the switch turns on into a discharged load capacitor or short-circuit, a capacitor needs to be placed between VIN and GND. A 1-μF ceramic capacitor, CIN, placed close to the pins is usually sufficient. Higher values of CIN can be used to further reduce the voltage drop.

Output Capacitor

A CIN to CL ratio of 10 to 1 is recommended for minimizing VIN dip caused by inrush currents during startup. Devices with faster rise times may require a larger ratio to minimize VIN dip.

Under-Voltage Lockout

Under-voltage lockout protection turns off the switch if the input voltage drops below the under-voltage lockout threshold. During under-voltage lockout (UVLO), if the voltage level at VOUT exceeds the voltage level at VIN by the Reverse Current Voltage Threshold (VRVP), the body diode will be disengaged to prevent any current flow to VIN. With the ON pin active, the input voltage rising above the under-voltage lockout threshold will cause a controlled turn-on of the switch to limit current over-shoot.

Reverse Current Protection

In a scenario where VOUT is greater than VIN, there is potential for reverse current to flow through the pass FET or the body diode. The TPS22910 monitors VIN and VOUT voltage levels. When the reverse current voltage threshold (VRVP) is exceeded, the switch is disabled (within 10μs typ). Additionally, the body diode is disengaged so as to prevent any reverse current flow to VIN. The FET, and the output (VOUT), will resume normal operation when the reverse current scenario is no longer present.

Use the following formula to calculate the amount of reverse current for a particular application:

$$I_{RC} = \frac{0.044V}{R_{ON(VIN)}}$$

Where,

IRC is the amount of reverse current,

RON(VIN) is the on-resistance at the VIN of the reverse current condition.

Board Layout

For best performance, all traces should be as short as possible. To be most effective, the input and output capacitors should be placed close to the device to minimize the effects that parasitic trace inductances may have on normal operation. Using wide traces for VIN, VOUT, and GND helps minimize the parasitic electrical effects along with minimizing the case to ambient thermal impedance.

REVISION HISTORY

Changes from Original (November 2011) to Revision A **Page**

- Deleted Quick Output Discharge Transistor from FEATURES. [1](#)
-

Changes from Revision A (March 2012) to Revision B **Page**

- Changed "active high" description for ON pin to "active low" in PIN FUNCTIONS table. [2](#)
-

PACKAGING INFORMATION

Orderable Device	Status ⁽¹⁾	Package Type	Package Drawing	Pins	Package Qty	Eco Plan ⁽²⁾	Lead/ Ball Finish	MSL Peak Temp ⁽³⁾	Samples (Requires Login)
TPS22910AYZVR	ACTIVE	DSBGA	YZV	4	3000	Green (RoHS & no Sb/Br)	SNAGCU	Level-1-260C-UNLIM	
TPS22910AYZVT	ACTIVE	DSBGA	YZV	4	250	Green (RoHS & no Sb/Br)	SNAGCU	Level-1-260C-UNLIM	

⁽¹⁾ The marketing status values are defined as follows:

ACTIVE: Product device recommended for new designs.

LIFEBUY: TI has announced that the device will be discontinued, and a lifetime-buy period is in effect.

NRND: Not recommended for new designs. Device is in production to support existing customers, but TI does not recommend using this part in a new design.

PREVIEW: Device has been announced but is not in production. Samples may or may not be available.

OBsolete: TI has discontinued the production of the device.

⁽²⁾ Eco Plan - The planned eco-friendly classification: Pb-Free (RoHS), Pb-Free (RoHS Exempt), or Green (RoHS & no Sb/Br) - please check <http://www.ti.com/productcontent> for the latest availability information and additional product content details.

TBD: The Pb-Free/Green conversion plan has not been defined.

Pb-Free (RoHS): TI's terms "Lead-Free" or "Pb-Free" mean semiconductor products that are compatible with the current RoHS requirements for all 6 substances, including the requirement that lead not exceed 0.1% by weight in homogeneous materials. Where designed to be soldered at high temperatures, TI Pb-Free products are suitable for use in specified lead-free processes.

Pb-Free (RoHS Exempt): This component has a RoHS exemption for either 1) lead-based flip-chip solder bumps used between the die and package, or 2) lead-based die adhesive used between the die and leadframe. The component is otherwise considered Pb-Free (RoHS compatible) as defined above.

Green (RoHS & no Sb/Br): TI defines "Green" to mean Pb-Free (RoHS compatible), and free of Bromine (Br) and Antimony (Sb) based flame retardants (Br or Sb do not exceed 0.1% by weight in homogeneous material)

⁽³⁾ MSL, Peak Temp. -- The Moisture Sensitivity Level rating according to the JEDEC industry standard classifications, and peak solder temperature.

Important Information and Disclaimer: The information provided on this page represents TI's knowledge and belief as of the date that it is provided. TI bases its knowledge and belief on information provided by third parties, and makes no representation or warranty as to the accuracy of such information. Efforts are underway to better integrate information from third parties. TI has taken and continues to take reasonable steps to provide representative and accurate information but may not have conducted destructive testing or chemical analysis on incoming materials and chemicals. TI and TI suppliers consider certain information to be proprietary, and thus CAS numbers and other limited information may not be available for release.

In no event shall TI's liability arising out of such information exceed the total purchase price of the TI part(s) at issue in this document sold by TI to Customer on an annual basis.

TAPE AND REEL INFORMATION
REEL DIMENSIONS

TAPE DIMENSIONS

A0	Dimension designed to accommodate the component width
B0	Dimension designed to accommodate the component length
K0	Dimension designed to accommodate the component thickness
W	Overall width of the carrier tape
P1	Pitch between successive cavity centers

TAPE AND REEL INFORMATION

*All dimensions are nominal

Device	Package Type	Package Drawing	Pins	SPQ	Reel Diameter (mm)	Reel Width W1 (mm)	A0 (mm)	B0 (mm)	K0 (mm)	P1 (mm)	W (mm)	Pin1 Quadrant
TPS22910AYZVR	DSBGA	YZV	4	3000	178.0	9.2	1.0	1.0	0.63	4.0	8.0	Q1
TPS22910AYZVT	DSBGA	YZV	4	250	178.0	9.2	1.0	1.0	0.63	4.0	8.0	Q1

TAPE AND REEL BOX DIMENSIONS

*All dimensions are nominal

Device	Package Type	Package Drawing	Pins	SPQ	Length (mm)	Width (mm)	Height (mm)
TPS22910AYZVR	DSBGA	YZV	4	3000	220.0	220.0	35.0
TPS22910AYZVT	DSBGA	YZV	4	250	220.0	220.0	35.0

YZV (S-XBGA-N4)

DIE-SIZE BALL GRID ARRAY

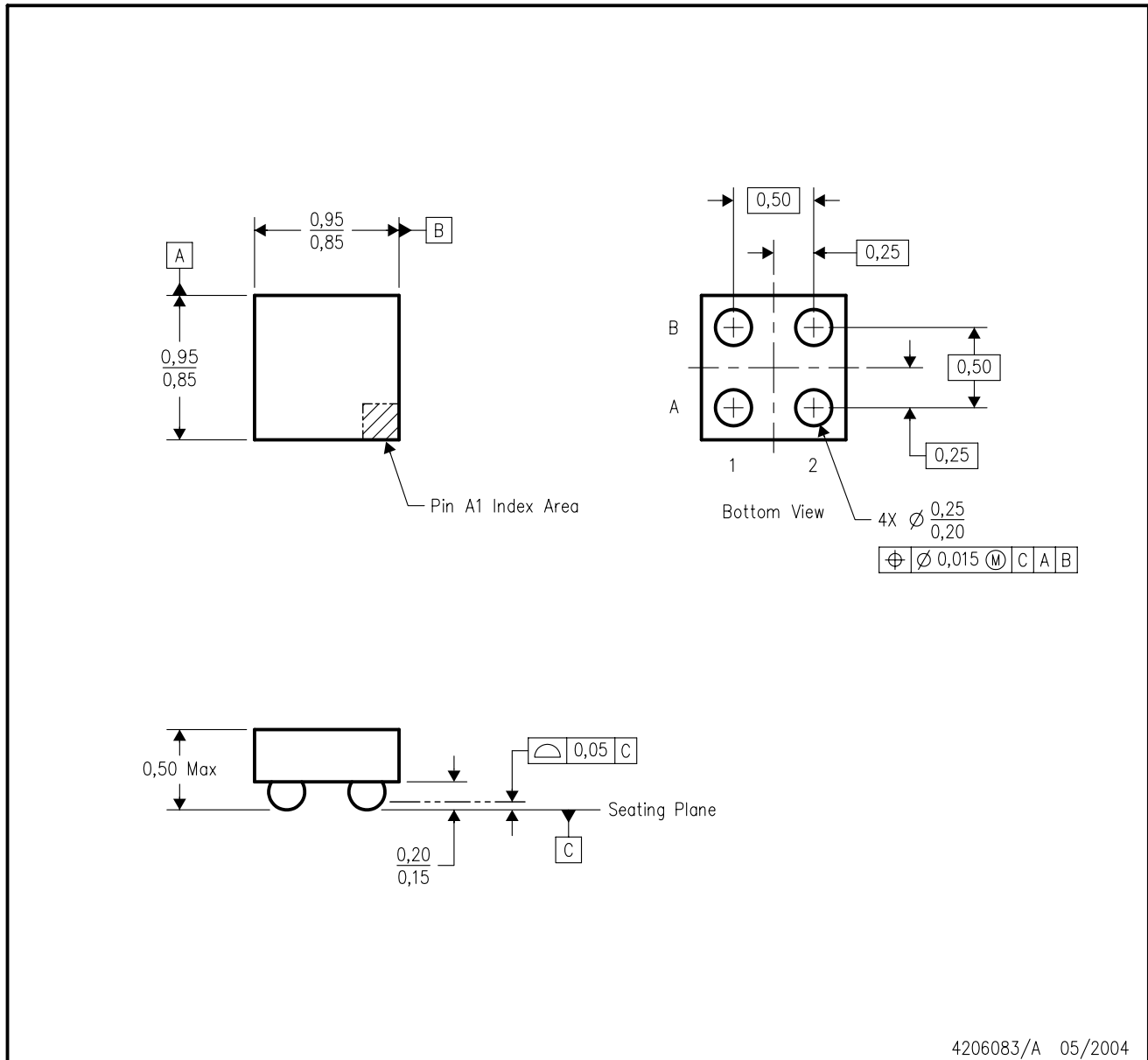

- NOTES:
- A. All linear dimensions are in millimeters.
 - B. This drawing is subject to change without notice.
 - C. NanoFree™ package configuration.
 - D. This package contains lead-free balls. Refer to the 4 YEV package (drawing 4206082) for tin-lead (SnPb) balls.

IMPORTANT NOTICE

Texas Instruments Incorporated and its subsidiaries (TI) reserve the right to make corrections, modifications, enhancements, improvements, and other changes to its products and services at any time and to discontinue any product or service without notice. Customers should obtain the latest relevant information before placing orders and should verify that such information is current and complete. All products are sold subject to TI's terms and conditions of sale supplied at the time of order acknowledgment.

TI warrants performance of its hardware products to the specifications applicable at the time of sale in accordance with TI's standard warranty. Testing and other quality control techniques are used to the extent TI deems necessary to support this warranty. Except where mandated by government requirements, testing of all parameters of each product is not necessarily performed.

TI assumes no liability for applications assistance or customer product design. Customers are responsible for their products and applications using TI components. To minimize the risks associated with customer products and applications, customers should provide adequate design and operating safeguards.

TI does not warrant or represent that any license, either express or implied, is granted under any TI patent right, copyright, mask work right, or other TI intellectual property right relating to any combination, machine, or process in which TI products or services are used. Information published by TI regarding third-party products or services does not constitute a license from TI to use such products or services or a warranty or endorsement thereof. Use of such information may require a license from a third party under the patents or other intellectual property of the third party, or a license from TI under the patents or other intellectual property of TI.

Reproduction of TI information in TI data books or data sheets is permissible only if reproduction is without alteration and is accompanied by all associated warranties, conditions, limitations, and notices. Reproduction of this information with alteration is an unfair and deceptive business practice. TI is not responsible or liable for such altered documentation. Information of third parties may be subject to additional restrictions.

Resale of TI products or services with statements different from or beyond the parameters stated by TI for that product or service voids all express and any implied warranties for the associated TI product or service and is an unfair and deceptive business practice. TI is not responsible or liable for any such statements.

TI products are not authorized for use in safety-critical applications (such as life support) where a failure of the TI product would reasonably be expected to cause severe personal injury or death, unless officers of the parties have executed an agreement specifically governing such use. Buyers represent that they have all necessary expertise in the safety and regulatory ramifications of their applications, and acknowledge and agree that they are solely responsible for all legal, regulatory and safety-related requirements concerning their products and any use of TI products in such safety-critical applications, notwithstanding any applications-related information or support that may be provided by TI. Further, Buyers must fully indemnify TI and its representatives against any damages arising out of the use of TI products in such safety-critical applications.

TI products are neither designed nor intended for use in military/aerospace applications or environments unless the TI products are specifically designated by TI as military-grade or "enhanced plastic." Only products designated by TI as military-grade meet military specifications. Buyers acknowledge and agree that any such use of TI products which TI has not designated as military-grade is solely at the Buyer's risk, and that they are solely responsible for compliance with all legal and regulatory requirements in connection with such use.

TI products are neither designed nor intended for use in automotive applications or environments unless the specific TI products are designated by TI as compliant with ISO/TS 16949 requirements. Buyers acknowledge and agree that, if they use any non-designated products in automotive applications, TI will not be responsible for any failure to meet such requirements.

Following are URLs where you can obtain information on other Texas Instruments products and application solutions:

Products

Audio	www.ti.com/audio
Amplifiers	amplifier.ti.com
Data Converters	dataconverter.ti.com
DLP® Products	www.dlp.com
DSP	dsp.ti.com
Clocks and Timers	www.ti.com/clocks
Interface	interface.ti.com
Logic	logic.ti.com
Power Mgmt	power.ti.com
Microcontrollers	microcontroller.ti.com
RFID	www.ti-rfid.com
OMAP Mobile Processors	www.ti.com/omap
Wireless Connectivity	www.ti.com/wirelessconnectivity

Applications

Automotive and Transportation	www.ti.com/automotive
Communications and Telecom	www.ti.com/communications
Computers and Peripherals	www.ti.com/computers
Consumer Electronics	www.ti.com/consumer-apps
Energy and Lighting	www.ti.com/energy
Industrial	www.ti.com/industrial
Medical	www.ti.com/medical
Security	www.ti.com/security
Space, Avionics and Defense	www.ti.com/space-avionics-defense
Video and Imaging	www.ti.com/video

TI E2E Community Home Page

e2e.ti.com

Mailing Address: Texas Instruments, Post Office Box 655303, Dallas, Texas 75265
Copyright © 2012, Texas Instruments Incorporated