

Features

- ◆ Ultra low capacitance: 3.5pF(Max)
- ◆ Ultra low leakage: nA level
- ◆ Low operating voltage: 5.5V
- ◆ Low clamping voltage
- ◆ Complies with following standards:
 - IEC 61000-4-2 (ESD) immunity test
 - Air discharge: ±20kV
 - Contact discharge: ±15kV
 - IEC61000-4-4 (EFT) 40A (5/50ns)
- ◆ ROHS Compliant

Ordering Information

Part Number	Qty per Reel	Reel Size
TPD4E002DRLR-TP	4000	7"

TPD4E002DRLR PIN to PIN fully compatible
Mechanical Characteristics

- ◆ Package: SOT-5X3
- ◆ Lead Finish: Matte Tin
- ◆ Case Material: “Green” Molding Compound.
- ◆ UL Flammability Classification Rating 94V-0
- ◆ Moisture Sensitivity: Level 3 per J-STD-020

Applications

- ◆ USB 2.0 and USB 3.0 Ports
- ◆ USB OTG
- ◆ Digital video interface(DVI)
- ◆ Monitor and Flat Panel Displays
- ◆ PCI Express and Serial SATA Ports
- ◆ Gigabit Ethernet
- ◆ IEEE 1394 firewire ports
- ◆ Consumer products (STB, DVD, DSC, DVC...)

Dimensions and Pin Configuration

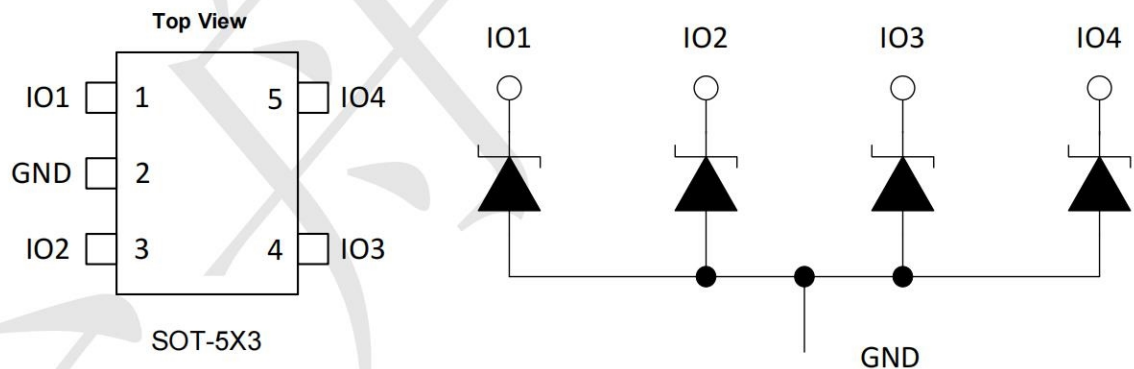

Marking: 28S

Absolute Maximum Ratings (Tamb=25°C unless otherwise specified)

Parameter	Symbol	Value	Unit
Operating voltage	V _{IO}	5	V
ESD Protection (per IEC 61000-4-2)	Air Discharge WM	20	kV
	Contact Discharge BR	15	

Parameter	Symbol	Min.	Nom.	Max.	Unit
Operating Temperature	T _J	-55	+25	+150	°C
Storage Temperature	T _{STG}	-55	+25	+150	°C

Electrical Characteristics (TA=25°C unless otherwise specified)

Parameter	Symbol	Min	Typ	Max	Unit
Working Peak Reverse Voltage	V _{WM}			5	V
Breakdown Voltage @ 1 mA	V _{BR}	6.5			V
Leakage Current @ V _{WM}	I _D			0.1	μA
Capacitance	C _{J(SD)}			3.5	pF
Forward Surge Rating (1/20 s @ 25 °C, I _F = 10 mA)	V _F	0.6	0.8	1.2	V
Clamping Voltage (per IEC 61000-4-5) 8/20 μs)	@ I _{PP} = 1 A			10	V
	@ I _{PP} = 3 A			12	

Application Schematic

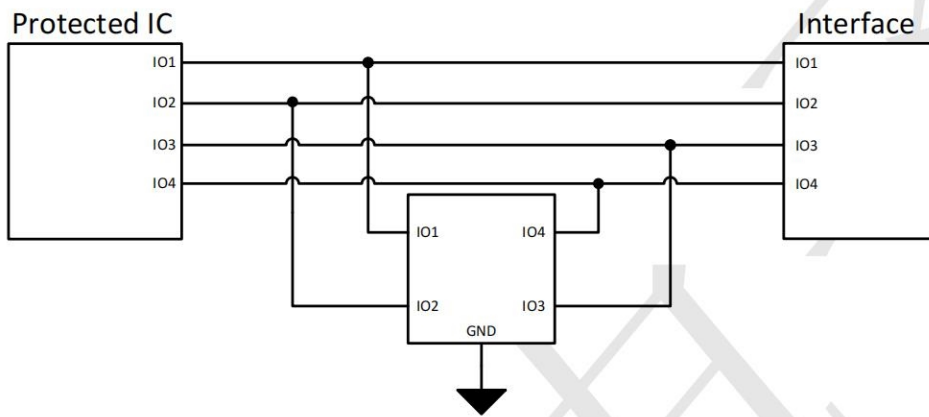

Typical Performance Characteristics ($T_A=25^\circ\text{C}$ unless otherwise Specified)

Fig1. 8/20 μs Pulse Waveform

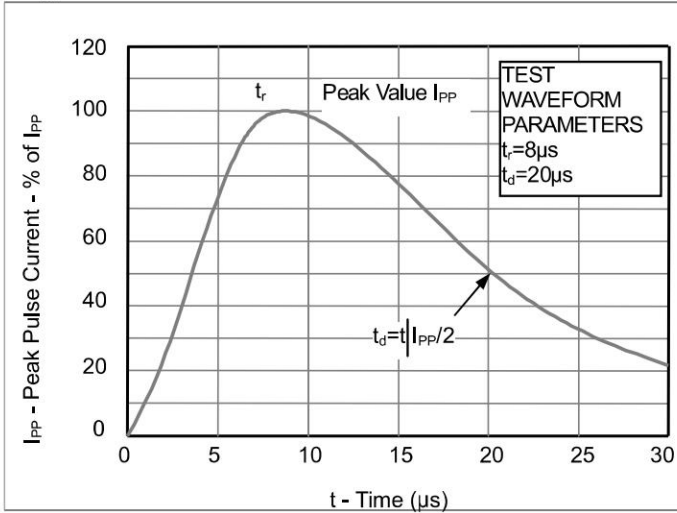

Fig2. ESD Pulse Waveform (according to IEC 61000-4-2)

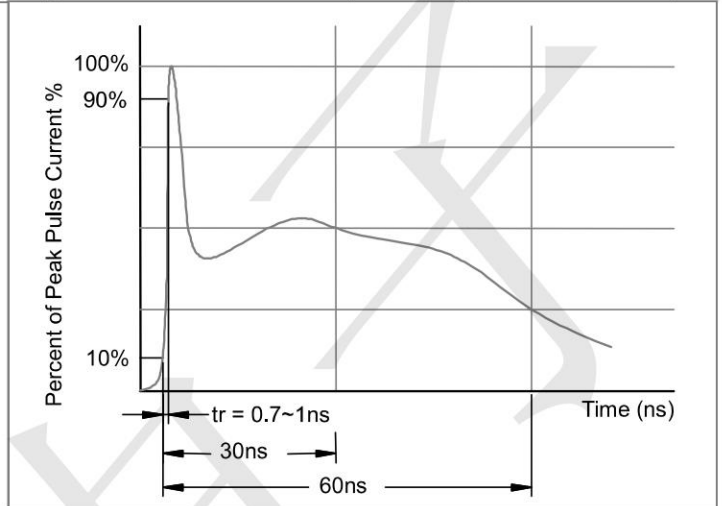
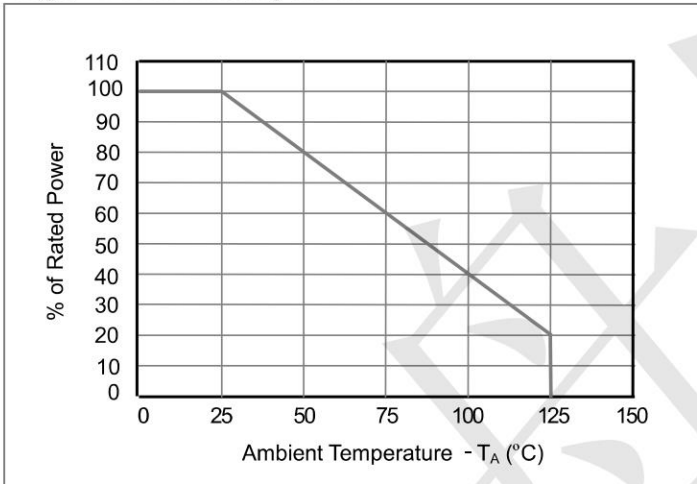
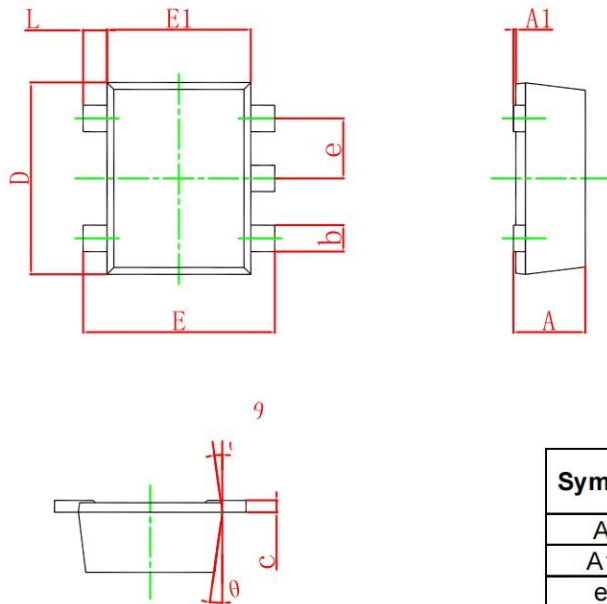

Fig3. Power Derating Curve



SOT-5X3 Package Outline Drawing



Symbol	Dimensions In Millimeters		Dimensions In Inches	
	Min.	Max.	Min.	Max.
A	0.525	0.600	0.021	0.024
A1	0.000	0.050	0.000	0.002
e	0.450	0.550	0.018	0.022
c	0.090	0.160	0.004	0.006
D	1.500	1.700	0.059	0.067
b	0.170	0.270	0.007	0.011
E1	1.100	1.300	0.043	0.051
E	1.500	1.700	0.059	0.067
L	0.100	0.300	0.004	0.012
θ	7° REF.		7° REF.	

Suggested Land Pattern

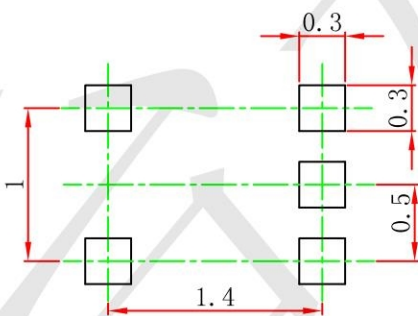

- Note:
1. Controlling dimension: in millimeters.
 2. General tolerance: ± 0.05 mm.
 3. The pad layout is for reference purposes only.