

1-, 2-A Step Down Converter with Forced PWM Feature in SOT563 Package

1 Features

- Forced PWM to Reduce Output Voltage Ripple
- Up to 95% Efficiency
- Low $R_{DS(ON)}$ Switches 100 m Ω / 60 m Ω
- 2.5-V to 5.5-V Input Voltage Range
- Adjustable Output Voltage from 0.6 V to V_{IN}
- 100% Duty Cycle for Lowest Dropout
- 1.5-MHz Typical Switching Frequency
- Power Good Output
- Over Current Protection
- Internal Soft Startup
- Thermal Shutdown Protection
- Available in SOT563 Package
- Pin-to-Pin Compatible with [TLV62568](#), [TLV62569](#)
- Create a Custom Design with the [WEBENCH® Power Designer](#)

2 Applications

- General Purpose POL Supply
- Set Top Box
- Network Video Camera
- Wireless Router
- Solid State Driver / Hard Disk Driver

3 Description

The TLV62568A, TLV62569A devices are synchronous step-down buck DC-DC converters optimized for high efficiency and compact solution size. The device integrates switches capable of delivering an output current up to 2 A. At the whole load range, the device operates in pulse width modulation (PWM) mode with 1.5-MHz switching frequency. In shutdown, the current consumption is reduced to less than 2 μ A.

An internal soft start circuit limits the inrush current during startup. Other features like over current protection, thermal shutdown protection and power good are built-in. The device is available in a SOT563 package.

Device Information⁽¹⁾

PART NUMBER	PACKAGE	BODY SIZE (NOM)
TLV62568ADRL	SOT563 (6)	1.60 mm x 1.60 mm
TLV62568APDRL		
TLV62569ADRL		
TLV62569APDRL		

(1) For all available packages, see the orderable addendum at the end of the datasheet.

Device Comparison

PART NUMBER	OUTPUT CURRENT	FUNCTION
TLV62568ADRL	1 A	-
TLV62568APDRL		Power Good
TLV62569ADRL	2 A	-
TLV62569APDRL		Power Good

Typical Application Schematic

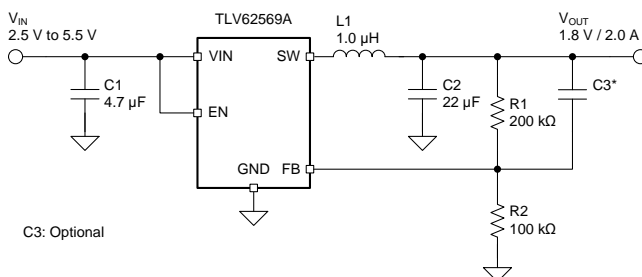

Efficiency at 5-V Input Voltage

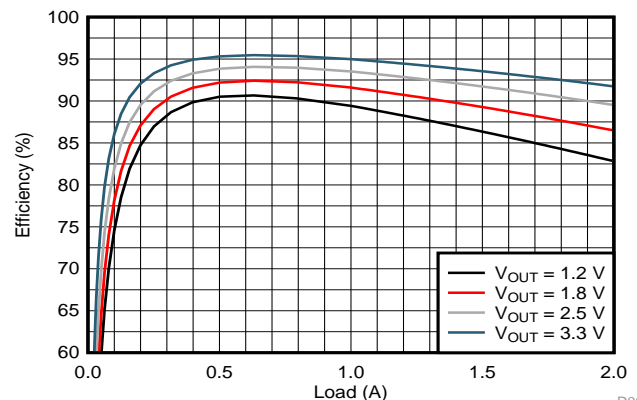

Table of Contents

1	Features	1	8	Application and Implementation	8
2	Applications	1	8.1	Application Information.....	8
3	Description	1	8.2	Typical Application	8
4	Revision History	2	9	Power Supply Recommendations	13
5	Pin Configuration and Functions	3	10	Layout	13
6	Specifications	3	10.1	Layout Guidelines	13
6.1	Absolute Maximum Ratings	3	10.2	Layout Example	13
6.2	ESD Ratings.....	3	10.3	Thermal Considerations	14
6.3	Recommended Operating Conditions	4	11	Device and Documentation Support	14
6.4	Thermal Information	4	11.1	Device Support	14
6.5	Electrical Characteristics.....	4	11.2	Documentation Support	14
6.6	Typical Characteristics.....	5	11.3	Receiving Notification of Documentation Updates	14
7	Detailed Description	6	11.4	Community Resources.....	15
7.1	Overview	6	11.5	Trademarks	15
7.2	Functional Block Diagrams	6	11.6	Electrostatic Discharge Caution.....	15
7.3	Feature Description.....	6	11.7	Glossary	15
7.4	Device Functional Modes.....	7	12	Mechanical, Packaging, and Orderable Information	15

4 Revision History

Changes from Original (April 2018) to Revision A

Page

•	Changed status from Advance Information to Production Data	1
---	--	---

5 Pin Configuration and Functions

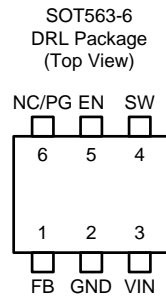

Pin Functions

NAME	SOT563-6	I/O/PWR	DESCRIPTION
	PIN NUMBER		
FB	1	I	Feedback pin for the internal control loop. Connect this pin to an external feedback divider.
GND	2	PWR	Ground pin.
VIN	3	PWR	Power supply voltage input.
SW	4	PWR	Switch pin connected to the internal FET switches and inductor terminal. Connect the inductor of the output filter to this pin.
EN	5	I	Device enable logic input. Logic high enables the device, logic low disables the device and turns it into shutdown. Do not leave floating.
PG	6	O	Power good open drain output pin for TLV62569APDRL. The pull-up resistor should not be connected to any voltage higher than 5.5V. If it's not used, leave the pin floating.
NC	6	-	No connection pin for TLV62569ADRL. The pin can be connected to the output or the ground for enhancing thermal performance. Or leave it floating.

6 Specifications

6.1 Absolute Maximum Ratings

over operating temperature range (unless otherwise noted)⁽¹⁾

		MIN	MAX	UNIT
Voltage ⁽²⁾	VIN, EN, PG	-0.3	6	V
	SW (DC)	-0.3	V _{IN} + 0.3	
	SW (AC, less than 10ns) ⁽³⁾	-3.0	9	
	FB	-0.3	3	
T _J	Junction temperature	-40	150	°C
T _{stg}	Storage temperature	-65	150	°C

(1) Stresses beyond those listed under *Absolute Maximum Rating* may cause permanent damage to the device. These are stress ratings only, which do not imply functional operation of the device at these or any other conditions beyond those indicated under *Recommended Operating Condition*. Exposure to absolute-maximum-rated conditions for extended periods may affect device reliability.

(2) All voltage values are with respect to network ground terminal.

(3) While switching.

6.2 ESD Ratings

		VALUE	UNIT
V _(ESD)	Electrostatic discharge	±2000	V
		±500	

(1) JEDEC document JEP155 states that 500-V HBM allows safe manufacturing with a standard ESD control process.

(2) JEDEC document JEP157 states that 250-V CDM allows safe manufacturing with a standard ESD control process.

6.3 Recommended Operating Conditions

over operating free-air temperature range (unless otherwise noted)

		MIN	NOM	MAX	UNIT
V_{IN}	Input voltage	2.5		5.5	V
V_{OUT}	Output voltage	0.6		V_{IN}	V
I_{OUT}	Output current	0		2	A
T_J	Junction temperature	-40		125	°C

6.4 Thermal Information

THERMAL METRIC ⁽¹⁾	TLV62568Ax, TLV62569Ax		UNIT	
	JEDEC (DRL)	EVM (DRL)		
	6 PINS	6 PINS		
$R_{\theta JA}$	Junction-to-ambient thermal resistance	142.8	124.8	°C/W
$R_{\theta JC(top)}$	Junction-to-case (top) thermal resistance	51.1	n/a ⁽²⁾	°C/W
$R_{\theta JB}$	Junction-to-board thermal resistance	28.9	n/a ⁽²⁾	°C/W
Ψ_{JT}	Junction-to-top characterization parameter	1.4	1.6	°C/W
Ψ_{JB}	Junction-to-board characterization parameter	28.7	23.1	°C/W

(1) For more information about traditional and new thermal metrics, see the [Semiconductor and IC Package Thermal Metrics](#) application report.

(2) Not applicable to an EVM.

6.5 Electrical Characteristics

 $V_{IN} = 5.0$ V, $T_J = 25$ °C, unless otherwise noted

PARAMETER	TEST CONDITIONS	MIN	TYP	MAX	UNIT
SUPPLY					
I_{SD}	Shutdown current into VIN pin	EN = 0 V	0.01	2	μA
V_{UVLO}	Under voltage lock out	V_{IN} falling	2.3	2.45	V
	under voltage lock out hysteresis		100		mV
T_{JSD}	Thermal shutdown	T_J rising	150		°C
		T_J falling	130		
LOGIC INTERFACE					
V_{IH}	High-level input voltage at EN pin	$2.5 \leq V_{IN} \leq 5.5$	1.2		V
V_{IL}	Low-level input voltage at EN pin	$2.5 \leq V_{IN} \leq 5.5$		0.4	V
t_{SS}	Soft startup time	From EN high to 95% of V_{OUT} nominal	0.9		ms
V_{PG}	Power good threshold	V_{FB} rising, referenced to V_{FB} nominal	95%		
		V_{FB} falling, referenced to V_{FB} nominal	90%		
$V_{PG,OL}$	Low-level output voltage at PG pin	$I_{SINK} = 1$ mA		0.4	V
$I_{PG,LKG}$	Input leakage current into PG pin	$V_{PG} = 5$ V	100		nA
$t_{PG,DLY}$	Power good delay time	V_{FB} falling	40		μs

Electrical Characteristics (continued)

$V_{IN} = 5.0\text{ V}$, $T_J = 25\text{ }^\circ\text{C}$, unless otherwise noted

PARAMETER	TEST CONDITIONS	MIN	TYP	MAX	UNIT
OUTPUT					
V_{FB}	Feedback regulation voltage	0.588	0.6	0.612	V
$R_{DS(on)}$	High-side FET on resistance		100		m Ω
	Low-side FET on resistance		60		
I_{LIM}	High-side FET current limit	TLV62569A, TLV62569AP	3		A
		TLV62568A, TLV62568AP	2		
f_{SW}	Switching frequency		1.5		MHz

6.6 Typical Characteristics

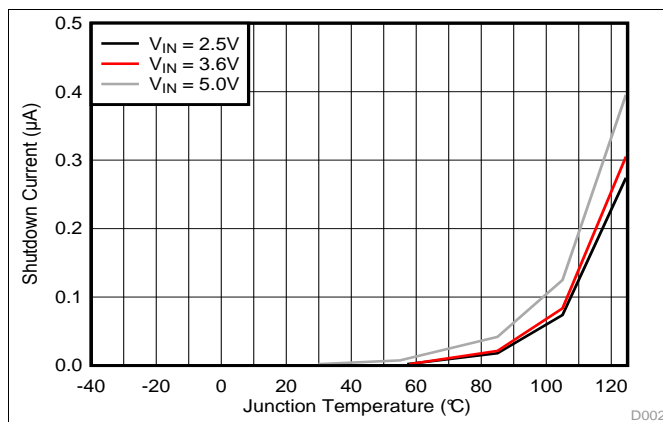

Figure 1. Shutdown Current vs Junction Temperature

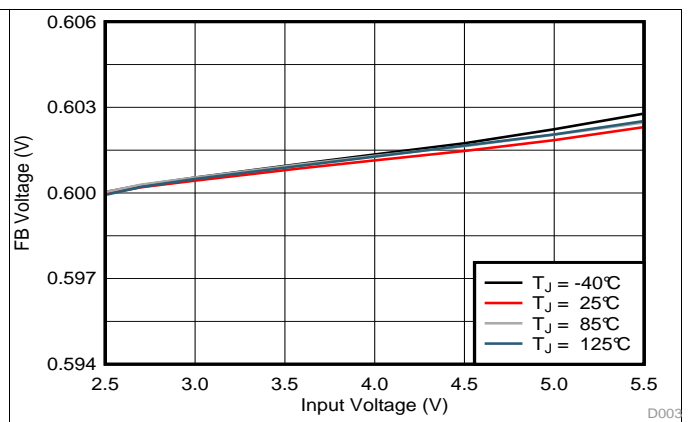

Figure 2. FB Voltage Accuracy

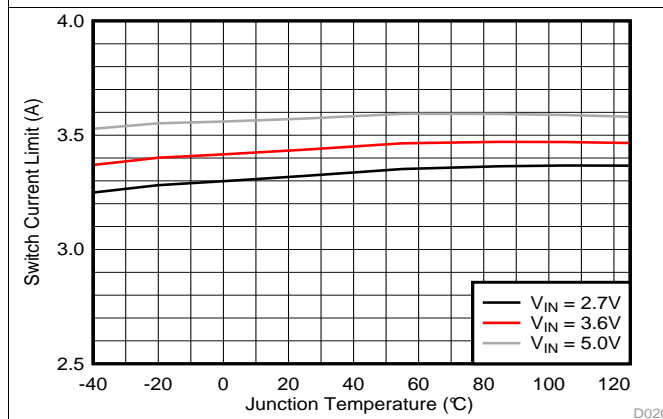

Figure 3. Switch Current Limit, TLV62569A

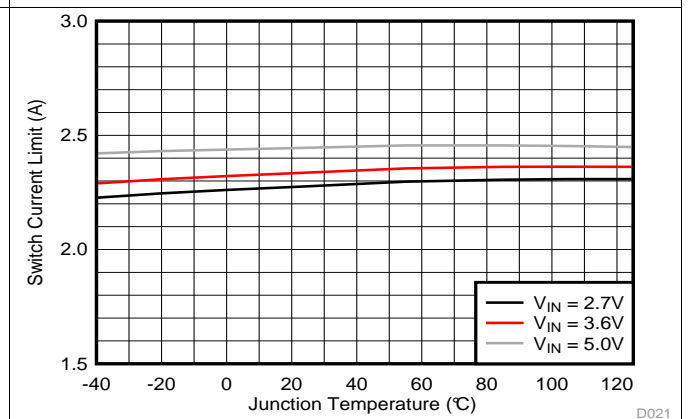

Figure 4. Switch Current Limit, TLV62568A

7 Detailed Description

7.1 Overview

The device is a high-efficiency synchronous step-down converter. The device operates with an adaptive off time with peak current control scheme. The device operates at typically 1.5-MHz frequency pulse width modulation (PWM). Based on the V_{IN}/V_{OUT} ratio, a simple circuit sets the required off time for the low-side MOSFET. It makes the switching frequency relatively constant regardless of the variation of input voltage, output voltage, and load current.

7.2 Functional Block Diagrams

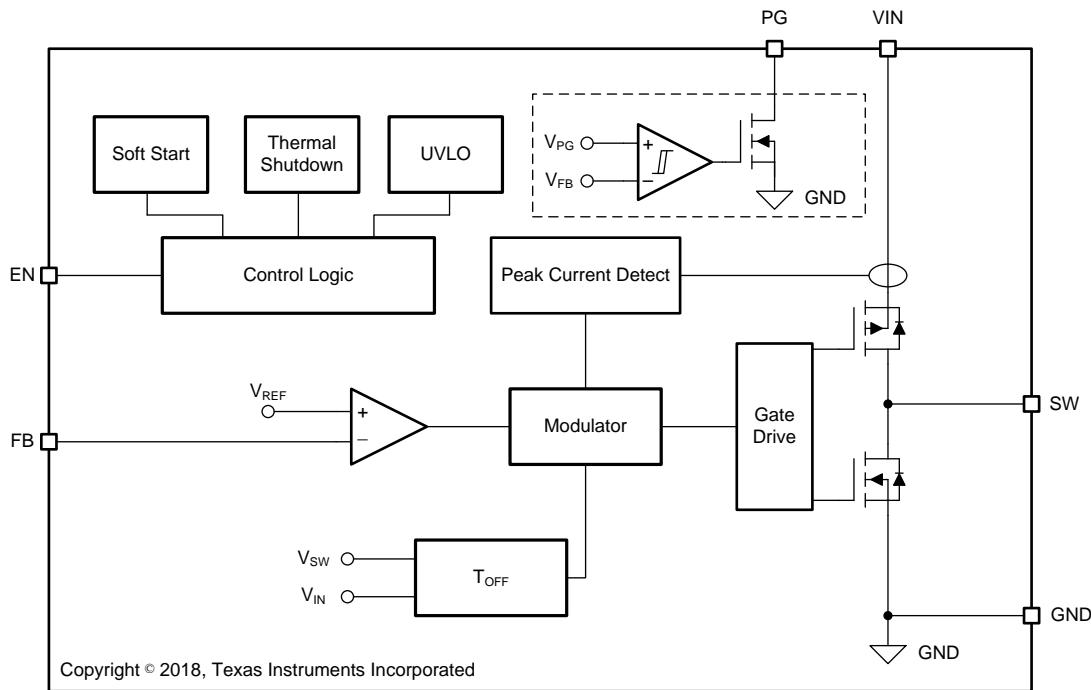

Figure 5. TLV62569A Functional Block Diagram

7.3 Feature Description

7.3.1 100% Duty Cycle Low Dropout Operation

The device offers a low input-to-output voltage differential by entering 100% duty cycle mode. In this mode, the high-side MOSFET switch is constantly turned on and the low-side MOSFET is switched off. The minimum input voltage to maintain output regulation, depending on the load current and output voltage, is calculated as:

$$V_{IN(MIN)} = V_{OUT} + I_{OUT} \times (R_{DS(ON)} + R_L)$$

where

- $R_{DS(ON)}$ = High side FET on-resistance
- R_L = Inductor ohmic resistance (DCR)

(1)

7.3.2 Soft Startup

After enabling the device, internal soft startup circuitry ramps up the output voltage which reaches nominal output voltage during a startup time. This avoids excessive inrush current and creates a smooth output voltage rise slope. It also prevents excessive voltage drops of primary cells and rechargeable batteries with high internal impedance.

Feature Description (continued)

The device is able to start into a pre-biased output capacitor. The converter starts with the applied bias voltage and ramps the output voltage to its nominal value.

7.3.3 Switch Current Limit

The switch current limit prevents the device from high inductor current and drawing excessive current from a battery or input voltage rail. Excessive current might occur with a heavy load or shorted output circuit condition. The device adopts the peak current control by sensing the current of the high-side switch. Once the high-side switch current limit is reached, the high-side switch is turned off and low-side switch is turned on to ramp down the inductor current with an adaptive off-time.

7.3.4 Under Voltage Lockout

To avoid mis-operation of the device at low input voltages, under voltage lockout is implemented that shuts down the device at voltages lower than V_{UVLO} with V_{HYS_UVLO} hysteresis.

7.3.5 Thermal Shutdown

The device enters thermal shutdown once the junction temperature exceeds the thermal shutdown rising threshold, T_{JSD} . Once the junction temperature falls below the falling threshold, the device returns to normal operation automatically.

7.4 Device Functional Modes

7.4.1 Enabling/Disabling the Device

The device is enabled by setting the EN input to a logic High. Accordingly, a logic Low disables the device. If the device is enabled, the internal power stage starts switching and regulates the output voltage to the set point voltage. The EN input must be terminated and should not be left floating.

7.4.2 Power Good

The TLV62568AP and TLV62569AP have a power good output. The PG pin goes high impedance once the output is above 95% of the nominal voltage, and is driven low once the output voltage falls below typically 90% of the nominal voltage. The PG pin is an open-drain output and is specified to sink up to 1 mA. The power good output requires a pull-up resistor connecting to any voltage rail less than 5.5 V. The PG signal can be used for sequencing of multiple rails by connecting it to the EN pin of other converters. Leave the PG pin unconnected when not used.

Table 1. PG Pin Logic

DEVICE CONDITIONS		LOGIC STATUS	
		HIGH Z	LOW
Enable	EN = High, $V_{FB} \geq V_{PG}$	√	
	EN = High, $V_{FB} \leq V_{PG}$		√
Shutdown	EN = Low		√
Thermal Shutdown	$T_J > T_{JSD}$		√
UVLO	$1.4\text{ V} < V_{IN} < V_{UVLO}$		√
Power Supply Removal	$V_{IN} \leq 1.4\text{ V}$	√	

8 Application and Implementation

NOTE

Information in the following applications sections is not part of the TI component specification, and TI does not warrant its accuracy or completeness. TI's customers are responsible for determining suitability of components for their purposes. Customers should validate and test their design implementation to confirm system functionality.

8.1 Application Information

The following section discusses the design of the external components to complete the power supply design for several input and output voltage options by using typical applications as a reference.

8.2 Typical Application

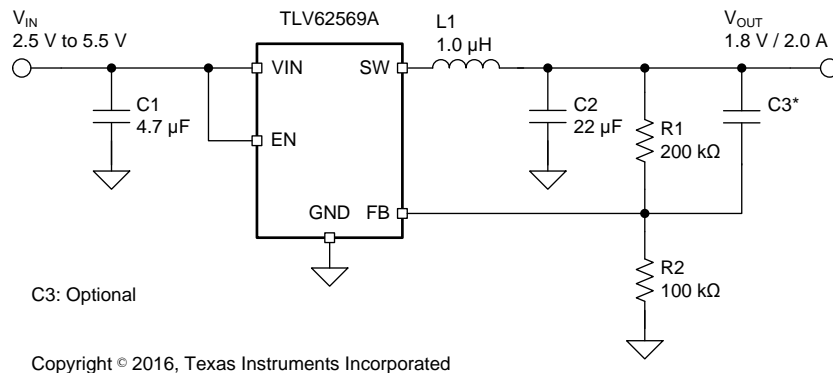

Figure 6. TLV62569A 1.8-V Output Application

8.2.1 Design Requirements

For this design example, use the parameters listed in [Table 2](#) as the input parameters.

Table 2. Design Parameters

DESIGN PARAMETER	EXAMPLE VALUE
Input voltage	2.5 V to 5.5 V
Output voltage	1.8 V
Maximum output current	2.0 A

[Table 3](#) lists the components used for the example.

Table 3. List of Components

REFERENCE	DESCRIPTION	MANUFACTURER ⁽¹⁾
C1	4.7 µF, Ceramic Capacitor, 10 V, X7R, size 0805, GRM21BR71A475KA73L	Murata
C2	22 µF, Ceramic Capacitor, 6.3 V, X7T, size 0805, GRM21BD70J226ME44	Murata
L1	1.0 µH, Power Inductor, size 4mmx4mm, XAL4020-102ME	Coilcraft
R1,R2,R3	Chip resistor, 1%, size 0603	Std.
C3	Optional, 10 pF if it is needed	Std.

(1) See [Third-party Products Disclaimer](#)

8.2.2 Detailed Design Procedure

8.2.2.1 Custom Design With WEBENCH® Tools

[Click here](#) to create a custom design using the TLV62569A device with the WEBENCH® Power Designer.

1. Start by entering the input voltage (V_{IN}), output voltage (V_{OUT}), and output current (I_{OUT}) requirements.
2. Optimize the design for key parameters such as efficiency, footprint, and cost using the optimizer dial.
3. Compare the generated design with other possible solutions from Texas Instruments.

The WEBENCH Power Designer provides a customized schematic along with a list of materials with real-time pricing and component availability.

In most cases, these actions are available:

- Run electrical simulations to see important waveforms and circuit performance
- Run thermal simulations to understand board thermal performance
- Export customized schematic and layout into popular CAD formats
- Print PDF reports for the design, and share the design with colleagues

Get more information about WEBENCH tools at www.ti.com/WEBENCH.

8.2.2.2 Setting the Output Voltage

An external resistor divider is used to set output voltage according to [Equation 2](#).

When sizing R2, in order to achieve low current consumption and acceptable noise sensitivity, use a maximum of 200 k Ω for R2. Larger currents through R2 improve noise sensitivity and output voltage accuracy but increase current consumption.

$$V_{OUT} = V_{FB} \times \left(1 + \frac{R1}{R2}\right) = 0.6V \times \left(1 + \frac{R1}{R2}\right) \quad (2)$$

A feed forward capacitor, C3 improves the loop bandwidth to make a fast transient response (shown in [Figure 24](#)). A 10-pF capacitance is recommended for R2 of 100-k Ω resistance. A more detailed discussion on the optimization for stability vs. transient response can be found in [SLVA289](#).

8.2.2.3 Output Filter Design

The inductor and output capacitor together provide a low-pass filter. To simplify this process, [Table 4](#) outlines possible inductor and capacitor value combinations. Checked cells represent combinations that are proven for stability by simulation and lab test. Further combinations should be checked for each individual application.

Table 4. Matrix of Output Capacitor and Inductor Combinations

V_{OUT} [V]	L [μ H] ⁽¹⁾	C_{OUT} [μ F] ⁽²⁾				
		4.7	10	22	47	100
$0.6 \leq V_{OUT} < 1.2$	1				+	
$1.2 \leq V_{OUT}$	1			++ ⁽³⁾	+	

(1) Inductor tolerance and current de-rating is anticipated. The effective inductance can vary by +20% and -30%.

(2) Capacitance tolerance and bias voltage de-rating is anticipated. The effective capacitance can vary by +20% and -50%.

(3) This LC combination is the standard value and recommended for most applications.

8.2.2.4 Inductor Selection

The main parameters for inductor selection is inductor value and then saturation current of the inductor. To calculate the maximum inductor current under static load conditions, [Equation 3](#) is given:

$$I_{L,MAX} = I_{OUT,MAX} + \frac{\Delta I_L}{2}$$

$$\Delta I_L = V_{OUT} \times \frac{1 - \frac{V_{OUT}}{V_{IN}}}{L \times f_{SW}}$$

where:

- $I_{OUT,MAX}$ is the maximum output current
- ΔI_L is the inductor current ripple

- f_{sw} is the switching frequency
 - L is the inductor value
- (3)

It is recommended to choose a saturation current for the inductor that is approximately 20% to 30% higher than $I_{L,MAX}$. In addition, DC resistance and size should also be taken into account when selecting an appropriate inductor.

8.2.2.5 Input and Output Capacitor Selection

The architecture of the device allows use of tiny ceramic-type output capacitors with low equivalent series resistance (ESR). These capacitors provide low output voltage ripple and are thus recommended. To keep its resistance up to high frequencies and to achieve narrow capacitance variation with temperature, it is recommended to use X7T or X5R dielectric.

The input capacitor is the low impedance energy source for the converter that helps provide stable operation. A low ESR multilayer ceramic capacitor is recommended for best filtering. For most applications, 4.7- μ F input capacitance is sufficient; a larger value reduces input voltage ripple.

The device is designed to operate with an output capacitor of 22 μ F to 47 μ F, as outlined in [Table 4](#).

8.2.3 Application Performance Curves

$V_{IN} = 5\text{ V}$, $V_{OUT} = 1.8\text{ V}$, $T_A = 25\text{ }^\circ\text{C}$, external components shown in [Table 3](#), unless otherwise noted.

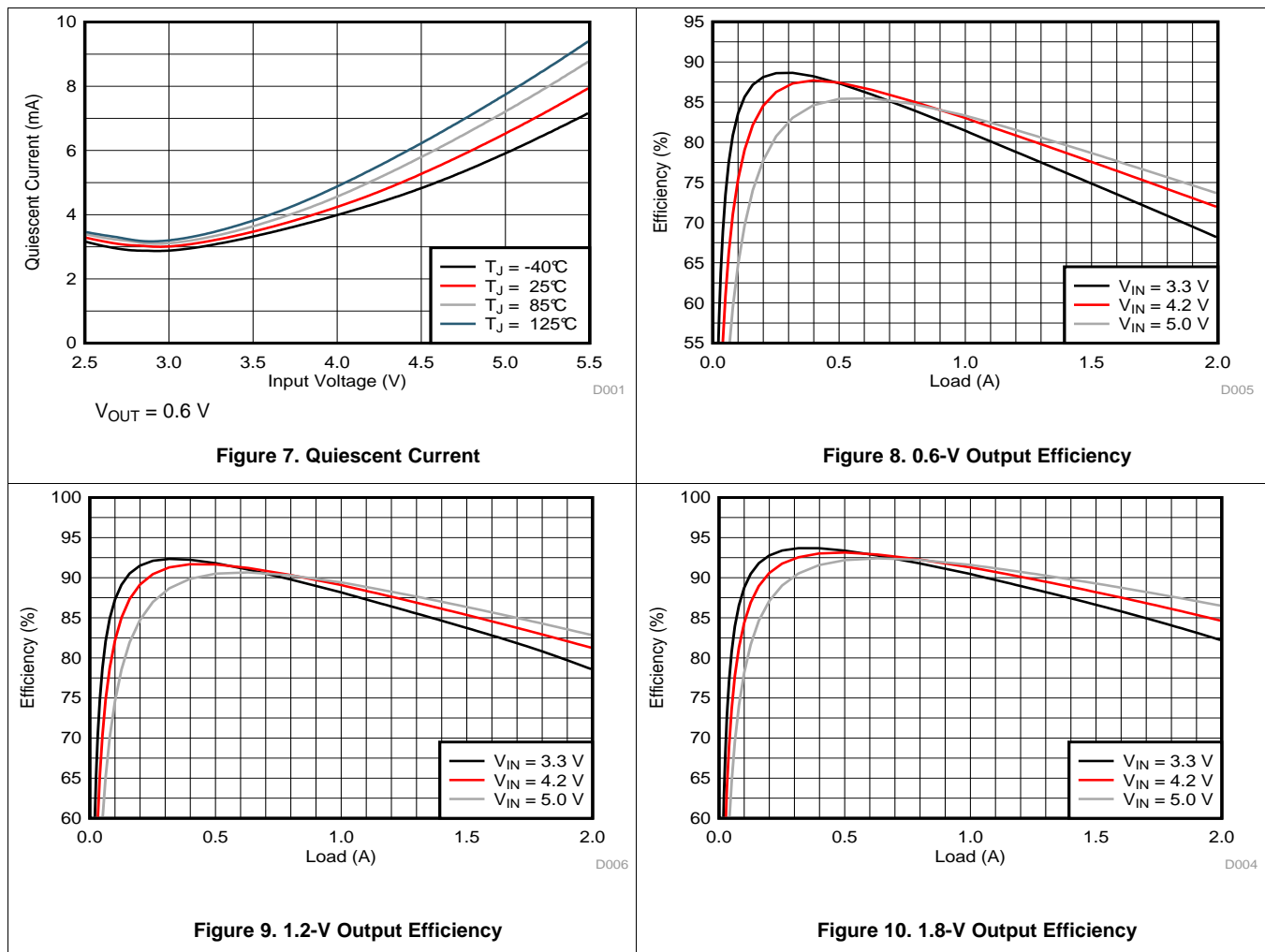

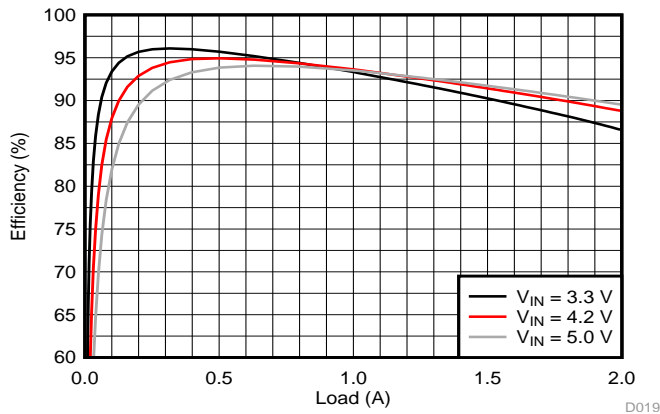

Figure 11. 2.5-V Output Efficiency

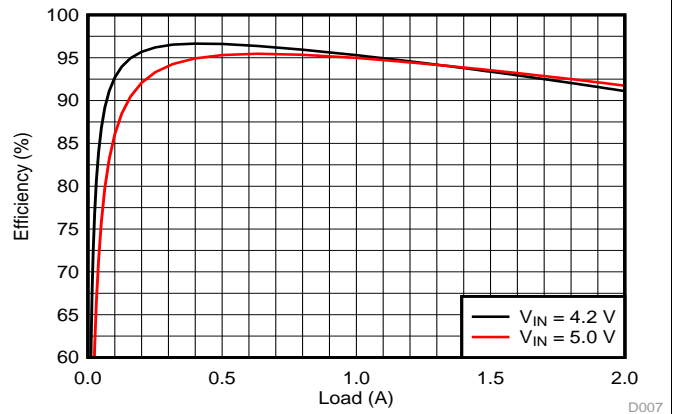

Figure 12. 3.3-V Output Efficiency

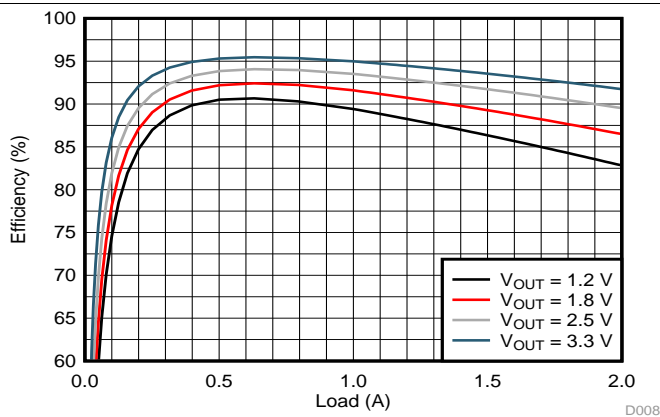

Figure 13. 5.0-V Input Efficiency

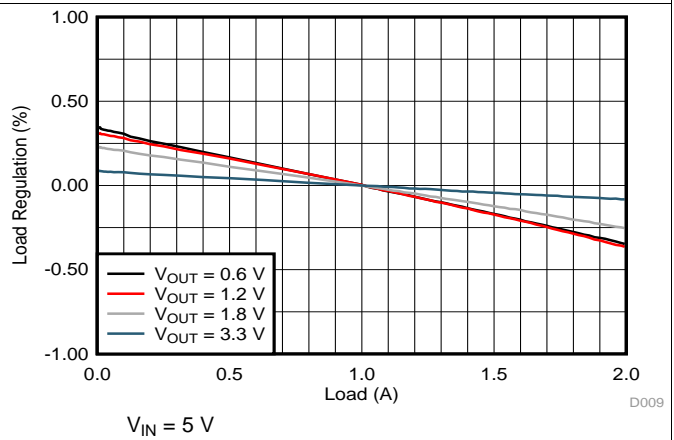

Figure 14. Load Regulation

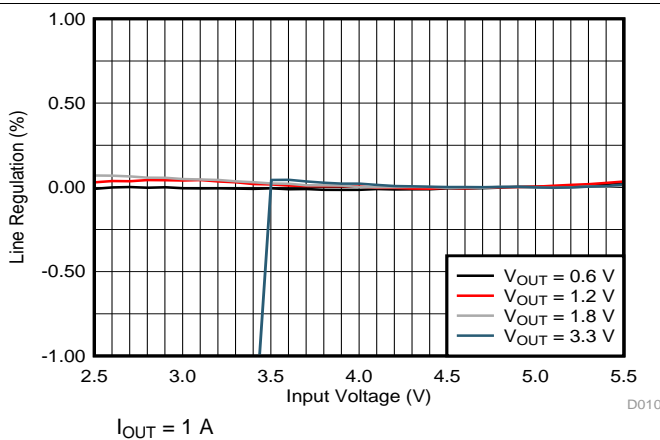

Figure 15. Line Regulation

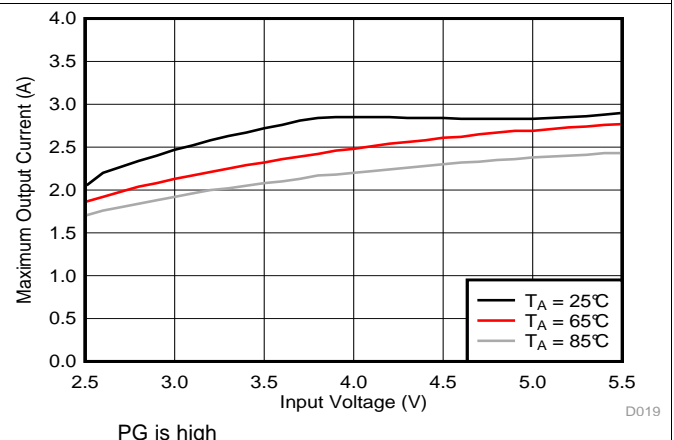

Figure 16. Maximum Output Current at V_OUT = 1.8 V

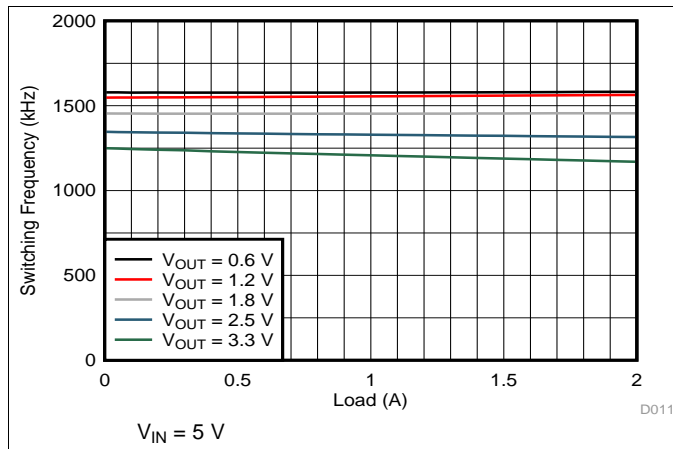

Figure 17. Switching Frequency vs Load

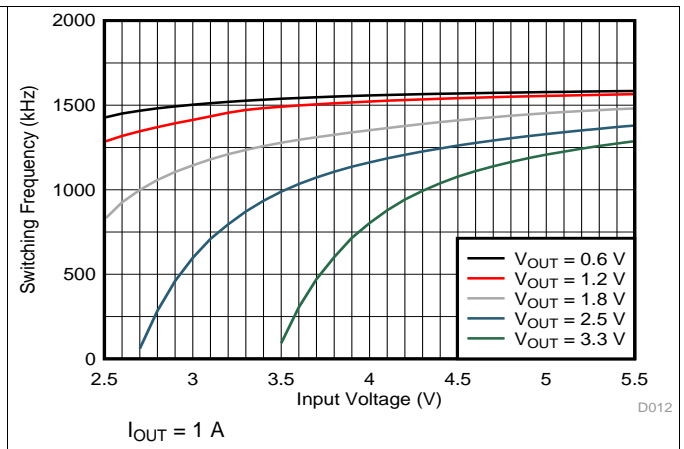

Figure 18. Switching Frequency vs Input Voltage

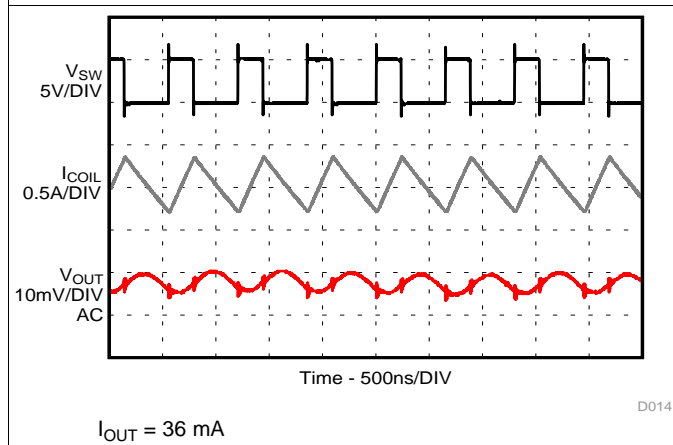

Figure 19. PWM Operation

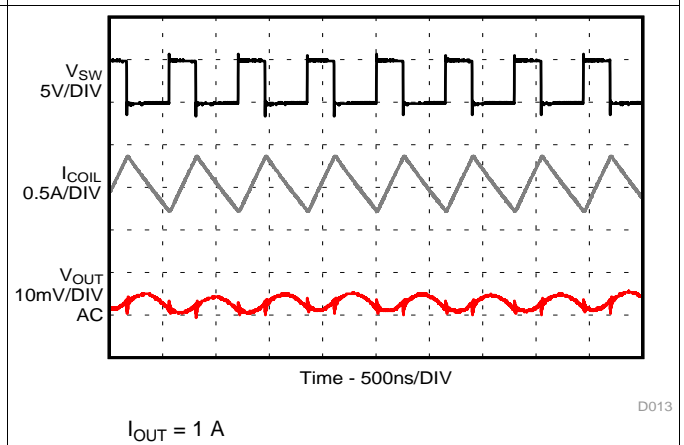

Figure 20. PWM Operation

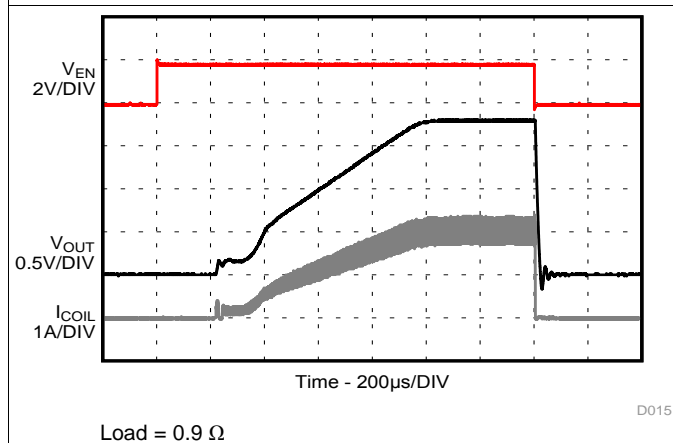

Figure 21. Startup and Shutdown with Load

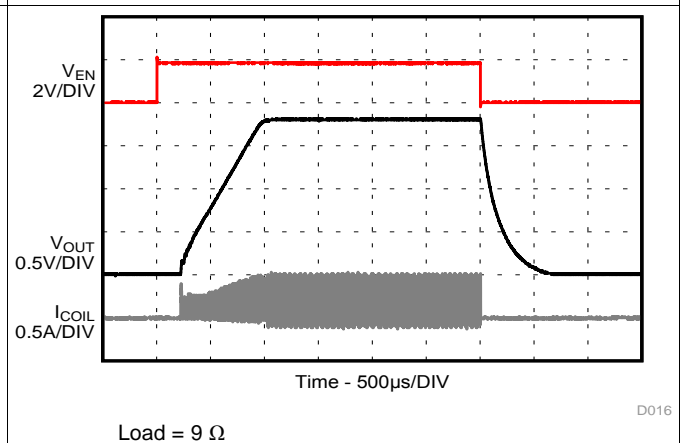
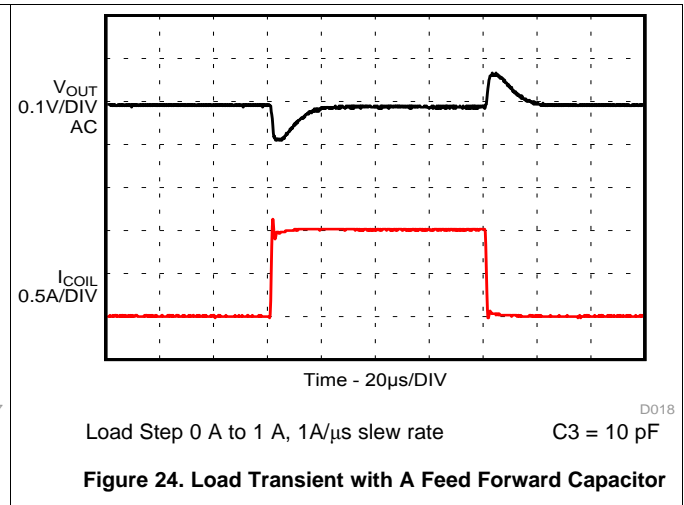
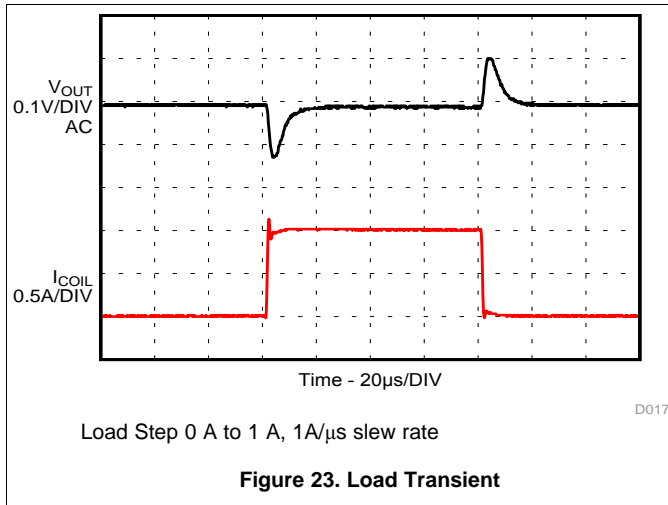

Figure 22. Startup and Shutdown with Load



9 Power Supply Recommendations

The power supply to the TLV62569A must have a current rating according to the supply voltage, output voltage and output current.

10 Layout

10.1 Layout Guidelines

The PCB layout is an important step to maintain the high performance of the TLV62569A device.

- The input/output capacitors and the inductor should be placed as close as possible to the IC. This keeps the power traces short. Routing these power traces direct and wide results in low trace resistance and low parasitic inductance.
- The low side of the input and output capacitors must be connected properly to the power GND to avoid a GND potential shift.
- The sense traces connected to FB are signal traces. Special care should be taken to avoid noise being induced. Keep these traces away from SW nodes.
- GND layers might be used for shielding.

10.2 Layout Example

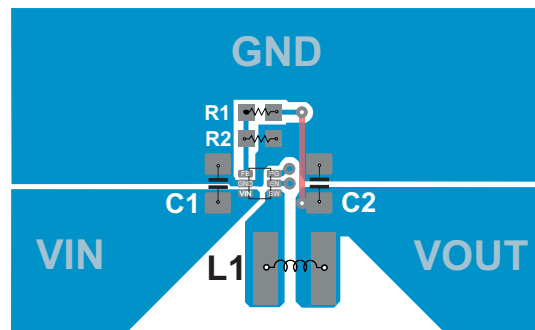

Figure 25. TLV62569APDRL Layout

10.3 Thermal Considerations

Implementation of integrated circuits in low-profile and fine-pitch surface-mount packages typically requires special attention to power dissipation. Many system-dependent issues such as thermal coupling, airflow, convection surfaces, and the presence of other heat-generating components affect the power dissipation limits of a given component.

Two basic approaches for enhancing thermal performance are listed below:

- Improving the power dissipation capability of the PCB design
- Introducing airflow in the system

For more details on how to use the thermal parameters, see the application notes: Thermal Characteristics Application Notes [SZZA017](#) and [SPRA953](#).

11 Device and Documentation Support

11.1 Device Support

11.1.1 Third-Party Products Disclaimer

TI'S PUBLICATION OF INFORMATION REGARDING THIRD-PARTY PRODUCTS OR SERVICES DOES NOT CONSTITUTE AN ENDORSEMENT REGARDING THE SUITABILITY OF SUCH PRODUCTS OR SERVICES OR A WARRANTY, REPRESENTATION OR ENDORSEMENT OF SUCH PRODUCTS OR SERVICES, EITHER ALONE OR IN COMBINATION WITH ANY TI PRODUCT OR SERVICE.

11.1.2 Development Support

11.1.2.1 Custom Design With WEBENCH® Tools

[Click here](#) to create a custom design using the TLV62569A device with the WEBENCH® Power Designer.

1. Start by entering the input voltage (V_{IN}), output voltage (V_{OUT}), and output current (I_{OUT}) requirements.
2. Optimize the design for key parameters such as efficiency, footprint, and cost using the optimizer dial.
3. Compare the generated design with other possible solutions from Texas Instruments.

The WEBENCH Power Designer provides a customized schematic along with a list of materials with real-time pricing and component availability.

In most cases, these actions are available:

- Run electrical simulations to see important waveforms and circuit performance
- Run thermal simulations to understand board thermal performance
- Export customized schematic and layout into popular CAD formats
- Print PDF reports for the design, and share the design with colleagues

Get more information about WEBENCH tools at www.ti.com/WEBENCH.

11.2 Documentation Support

11.2.1 Related Documentation

Semiconductor and IC Package Thermal Metrics Application Report ([SPRA953](#))

Thermal Characteristics of Linear and Logic Packages Using JEDEC PCB Designs Application Report ([SZZA017](#))

11.3 Receiving Notification of Documentation Updates

To receive notification of documentation updates, navigate to the device product folder on ti.com. In the upper right corner, click on *Alert me* to register and receive a weekly digest of any product information that has changed. For change details, review the revision history included in any revised document.

11.4 Community Resources

The following links connect to TI community resources. Linked contents are provided "AS IS" by the respective contributors. They do not constitute TI specifications and do not necessarily reflect TI's views; see TI's [Terms of Use](#).

TI E2E™ Online Community *TI's Engineer-to-Engineer (E2E) Community*. Created to foster collaboration among engineers. At e2e.ti.com, you can ask questions, share knowledge, explore ideas and help solve problems with fellow engineers.

Design Support *TI's Design Support* Quickly find helpful E2E forums along with design support tools and contact information for technical support.

11.5 Trademarks

E2E is a trademark of Texas Instruments.

WEBENCH is a registered trademark of Texas Instruments.

11.6 Electrostatic Discharge Caution



These devices have limited built-in ESD protection. The leads should be shorted together or the device placed in conductive foam during storage or handling to prevent electrostatic damage to the MOS gates.

11.7 Glossary

[SLYZ022](#) — *TI Glossary*.

This glossary lists and explains terms, acronyms, and definitions.

12 Mechanical, Packaging, and Orderable Information

The following pages include mechanical, packaging, and orderable information. This information is the most current data available for the designated devices. This data is subject to change without notice and revision of this document. For browser-based versions of this data sheet, refer to the left-hand navigation.

PACKAGING INFORMATION

Orderable Device	Status (1)	Package Type	Package Drawing	Pins	Package Qty	Eco Plan (2)	Lead/Ball Finish (6)	MSL Peak Temp (3)	Op Temp (°C)	Device Marking (4/5)	Samples
TLV62568ADRLR	ACTIVE	SOT-5X3	DRL	6	3000	Green (RoHS & no Sb/Br)	CU SN	Level-1-260C-UNLIM	-40 to 125	1BE	Samples
TLV62568ADRLT	ACTIVE	SOT-5X3	DRL	6	250	Green (RoHS & no Sb/Br)	CU SN	Level-1-260C-UNLIM	-40 to 125	1BE	Samples
TLV62568APDRLR	ACTIVE	SOT-5X3	DRL	6	3000	Green (RoHS & no Sb/Br)	CU SN	Level-1-260C-UNLIM	-40 to 125	1BF	Samples
TLV62568APDRLT	ACTIVE	SOT-5X3	DRL	6	250	Green (RoHS & no Sb/Br)	CU SN	Level-1-260C-UNLIM	-40 to 125	1BF	Samples
TLV62569ADRLR	ACTIVE	SOT-5X3	DRL	6	3000	Green (RoHS & no Sb/Br)	CU SN	Level-1-260C-UNLIM	-40 to 125	1BG	Samples
TLV62569ADRLT	ACTIVE	SOT-5X3	DRL	6	250	Green (RoHS & no Sb/Br)	CU SN	Level-1-260C-UNLIM	-40 to 125	1BG	Samples
TLV62569APDRLR	ACTIVE	SOT-5X3	DRL	6	3000	Green (RoHS & no Sb/Br)	CU SN	Level-1-260C-UNLIM	-40 to 125	1BH	Samples
TLV62569APDRLT	ACTIVE	SOT-5X3	DRL	6	250	Green (RoHS & no Sb/Br)	CU SN	Level-1-260C-UNLIM	-40 to 125	1BH	Samples
XLV62568APDRLT	ACTIVE	SOT-5X3	DRL	6	250	TBD	Call TI	Call TI	-40 to 125		Samples
XLV62569APDRLT	ACTIVE	SOT-5X3	DRL	6	250	TBD	Call TI	Call TI	-40 to 125		Samples

(1) The marketing status values are defined as follows:

ACTIVE: Product device recommended for new designs.

LIFEBUY: TI has announced that the device will be discontinued, and a lifetime-buy period is in effect.

NRND: Not recommended for new designs. Device is in production to support existing customers, but TI does not recommend using this part in a new design.

PREVIEW: Device has been announced but is not in production. Samples may or may not be available.

OBSELETE: TI has discontinued the production of the device.

(2) **RoHS:** TI defines "RoHS" to mean semiconductor products that are compliant with the current EU RoHS requirements for all 10 RoHS substances, including the requirement that RoHS substance do not exceed 0.1% by weight in homogeneous materials. Where designed to be soldered at high temperatures, "RoHS" products are suitable for use in specified lead-free processes. TI may reference these types of products as "Pb-Free".

RoHS Exempt: TI defines "RoHS Exempt" to mean products that contain lead but are compliant with EU RoHS pursuant to a specific EU RoHS exemption.

Green: TI defines "Green" to mean the content of Chlorine (Cl) and Bromine (Br) based flame retardants meet JS709B low halogen requirements of <=1000ppm threshold. Antimony trioxide based flame retardants must also meet the <=1000ppm threshold requirement.

(3) MSL, Peak Temp. - The Moisture Sensitivity Level rating according to the JEDEC industry standard classifications, and peak solder temperature.

(4) There may be additional marking, which relates to the logo, the lot trace code information, or the environmental category on the device.

(5) Multiple Device Markings will be inside parentheses. Only one Device Marking contained in parentheses and separated by a "~" will appear on a device. If a line is indented then it is a continuation of the previous line and the two combined represent the entire Device Marking for that device.

(6) Lead/Ball Finish - Orderable Devices may have multiple material finish options. Finish options are separated by a vertical ruled line. Lead/Ball Finish values may wrap to two lines if the finish value exceeds the maximum column width.

Important Information and Disclaimer:The information provided on this page represents TI's knowledge and belief as of the date that it is provided. TI bases its knowledge and belief on information provided by third parties, and makes no representation or warranty as to the accuracy of such information. Efforts are underway to better integrate information from third parties. TI has taken and continues to take reasonable steps to provide representative and accurate information but may not have conducted destructive testing or chemical analysis on incoming materials and chemicals. TI and TI suppliers consider certain information to be proprietary, and thus CAS numbers and other limited information may not be available for release.

In no event shall TI's liability arising out of such information exceed the total purchase price of the TI part(s) at issue in this document sold by TI to Customer on an annual basis.

TAPE AND REEL INFORMATION

QUADRANT ASSIGNMENTS FOR PIN 1 ORIENTATION IN TAPE

*All dimensions are nominal

Device	Package Type	Package Drawing	Pins	SPQ	Reel Diameter (mm)	Reel Width W1 (mm)	A0 (mm)	B0 (mm)	K0 (mm)	P1 (mm)	W (mm)	Pin1 Quadrant
TLV62568ADRLR	SOT-5X3	DRL	6	3000	180.0	9.5	1.78	1.78	0.69	4.0	8.0	Q3
TLV62568ADRLT	SOT-5X3	DRL	6	250	180.0	9.5	1.78	1.78	0.69	4.0	8.0	Q3
TLV62568APDRLR	SOT-5X3	DRL	6	3000	180.0	9.5	1.78	1.78	0.69	4.0	8.0	Q3
TLV62568APDRLT	SOT-5X3	DRL	6	250	180.0	9.5	1.78	1.78	0.69	4.0	8.0	Q3
TLV62569ADRLR	SOT-5X3	DRL	6	3000	180.0	9.5	1.78	1.78	0.69	4.0	8.0	Q3
TLV62569ADRLT	SOT-5X3	DRL	6	250	180.0	9.5	1.78	1.78	0.69	4.0	8.0	Q3
TLV62569APDRLR	SOT-5X3	DRL	6	3000	180.0	9.5	1.78	1.78	0.69	4.0	8.0	Q3
TLV62569APDRLT	SOT-5X3	DRL	6	250	180.0	9.5	1.78	1.78	0.69	4.0	8.0	Q3

TAPE AND REEL BOX DIMENSIONS

*All dimensions are nominal

Device	Package Type	Package Drawing	Pins	SPQ	Length (mm)	Width (mm)	Height (mm)
TLV62568ADRLR	SOT-5X3	DRL	6	3000	184.0	184.0	19.0
TLV62568ADRLT	SOT-5X3	DRL	6	250	184.0	184.0	19.0
TLV62568APDRLR	SOT-5X3	DRL	6	3000	184.0	184.0	19.0
TLV62568APDRLT	SOT-5X3	DRL	6	250	184.0	184.0	19.0
TLV62569ADRLR	SOT-5X3	DRL	6	3000	184.0	184.0	19.0
TLV62569ADRLT	SOT-5X3	DRL	6	250	184.0	184.0	19.0
TLV62569APDRLR	SOT-5X3	DRL	6	3000	184.0	184.0	19.0
TLV62569APDRLT	SOT-5X3	DRL	6	250	184.0	184.0	19.0

DRL (R-PDSO-N6)

PLASTIC SMALL OUTLINE

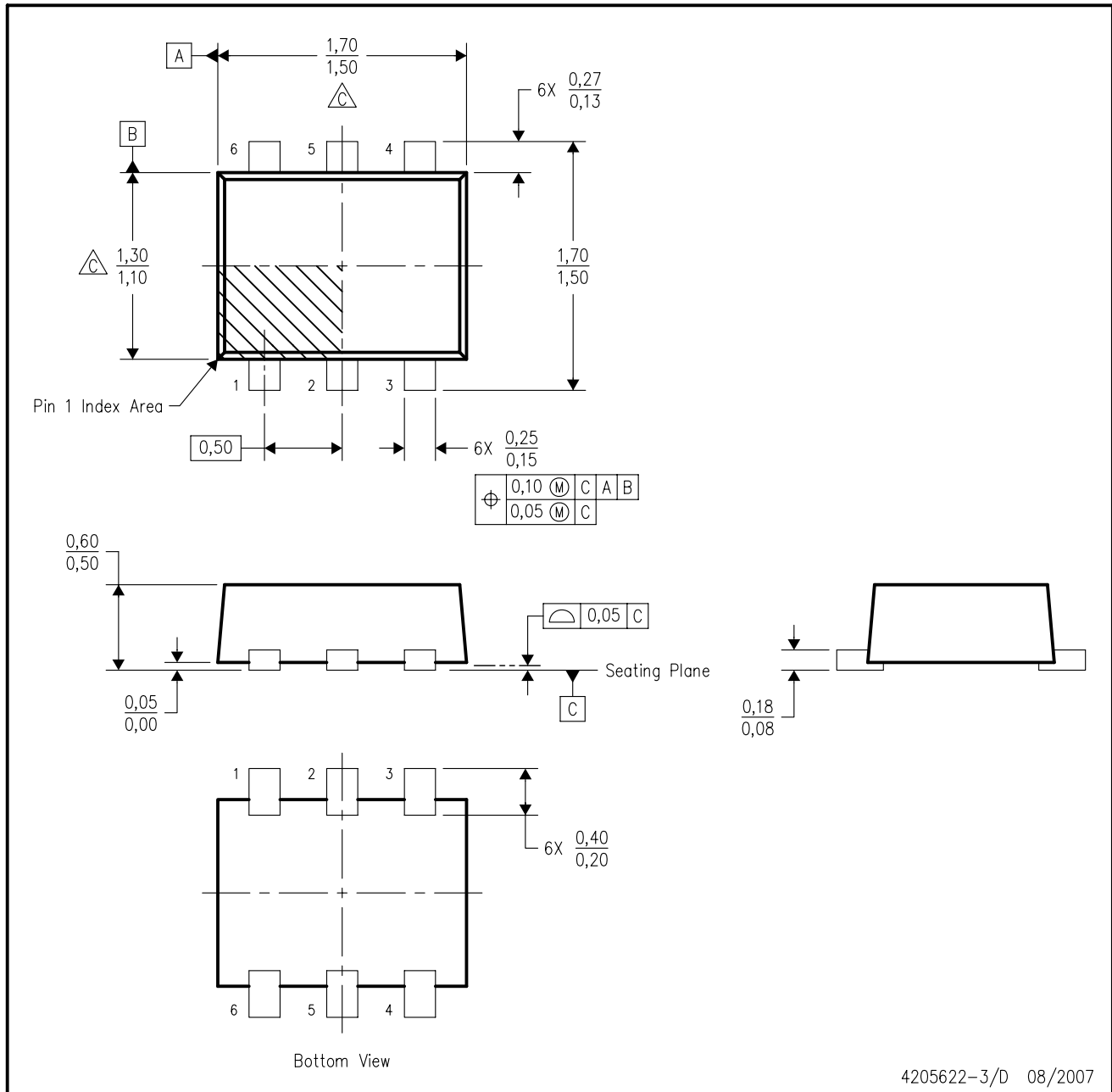

- NOTES:
- A. All linear dimensions are in millimeters. Dimensioning and tolerancing per ASME Y14.5M-1994.
 - B. This drawing is subject to change without notice.
 - C. Body dimensions do not include mold flash, interlead flash, protrusions, or gate burrs. Mold flash, interlead flash, protrusions, or gate burrs shall not exceed 0,15 per end or side.
 - D. JEDEC package registration is pending.

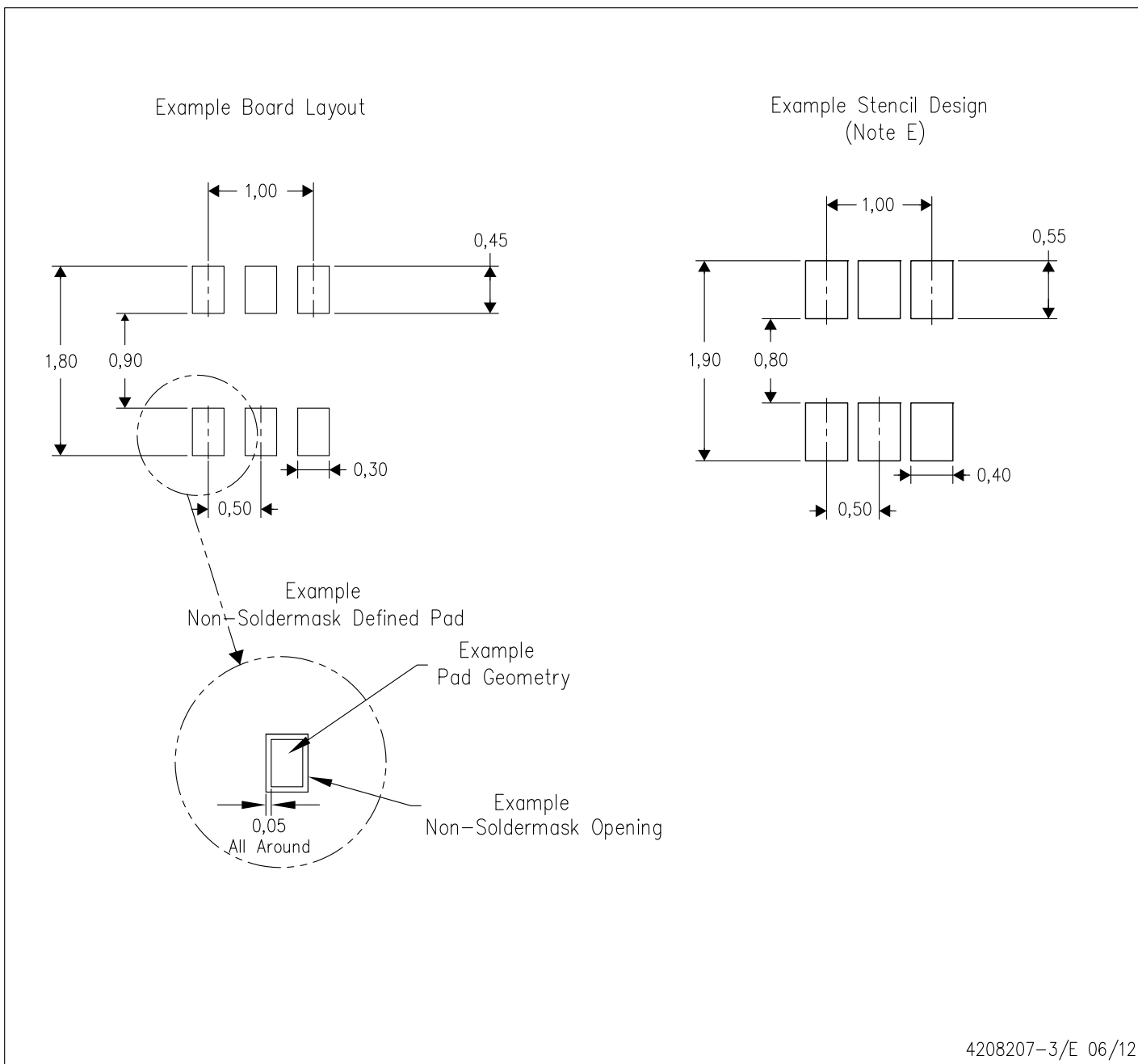

- NOTES:
- A. All linear dimensions are in millimeters.
 - B. This drawing is subject to change without notice.
 - C. Publication IPC-7351 is recommended for alternate designs.
 - D. Customers should contact their board fabrication site for minimum solder mask web tolerances between signal pads.
 - E. Maximum stencil thickness 0,127 mm (5 mils). All linear dimensions are in millimeters.
 - F. Laser cutting apertures with trapezoidal walls and also rounding corners will offer better paste release. Customers should contact their board assembly site for stencil design recommendations. Refer to IPC 7525 for stencil design considerations.
 - G. Side aperture dimensions over-print land for acceptable area ratio > 0.66. Customer may reduce side aperture dimensions if stencil manufacturing process allows for sufficient release at smaller opening.

IMPORTANT NOTICE

Texas Instruments Incorporated (TI) reserves the right to make corrections, enhancements, improvements and other changes to its semiconductor products and services per JESD46, latest issue, and to discontinue any product or service per JESD48, latest issue. Buyers should obtain the latest relevant information before placing orders and should verify that such information is current and complete.

TI's published terms of sale for semiconductor products (<http://www.ti.com/sc/docs/stdterms.htm>) apply to the sale of packaged integrated circuit products that TI has qualified and released to market. Additional terms may apply to the use or sale of other types of TI products and services.

Reproduction of significant portions of TI information in TI data sheets is permissible only if reproduction is without alteration and is accompanied by all associated warranties, conditions, limitations, and notices. TI is not responsible or liable for such reproduced documentation. Information of third parties may be subject to additional restrictions. Resale of TI products or services with statements different from or beyond the parameters stated by TI for that product or service voids all express and any implied warranties for the associated TI product or service and is an unfair and deceptive business practice. TI is not responsible or liable for any such statements.

Buyers and others who are developing systems that incorporate TI products (collectively, "Designers") understand and agree that Designers remain responsible for using their independent analysis, evaluation and judgment in designing their applications and that Designers have full and exclusive responsibility to assure the safety of Designers' applications and compliance of their applications (and of all TI products used in or for Designers' applications) with all applicable regulations, laws and other applicable requirements. Designer represents that, with respect to their applications, Designer has all the necessary expertise to create and implement safeguards that (1) anticipate dangerous consequences of failures, (2) monitor failures and their consequences, and (3) lessen the likelihood of failures that might cause harm and take appropriate actions. Designer agrees that prior to using or distributing any applications that include TI products, Designer will thoroughly test such applications and the functionality of such TI products as used in such applications.

TI's provision of technical, application or other design advice, quality characterization, reliability data or other services or information, including, but not limited to, reference designs and materials relating to evaluation modules, (collectively, "TI Resources") are intended to assist designers who are developing applications that incorporate TI products; by downloading, accessing or using TI Resources in any way, Designer (individually or, if Designer is acting on behalf of a company, Designer's company) agrees to use any particular TI Resource solely for this purpose and subject to the terms of this Notice.

TI's provision of TI Resources does not expand or otherwise alter TI's applicable published warranties or warranty disclaimers for TI products, and no additional obligations or liabilities arise from TI providing such TI Resources. TI reserves the right to make corrections, enhancements, improvements and other changes to its TI Resources. TI has not conducted any testing other than that specifically described in the published documentation for a particular TI Resource.

Designer is authorized to use, copy and modify any individual TI Resource only in connection with the development of applications that include the TI product(s) identified in such TI Resource. NO OTHER LICENSE, EXPRESS OR IMPLIED, BY ESTOPPEL OR OTHERWISE TO ANY OTHER TI INTELLECTUAL PROPERTY RIGHT, AND NO LICENSE TO ANY TECHNOLOGY OR INTELLECTUAL PROPERTY RIGHT OF TI OR ANY THIRD PARTY IS GRANTED HEREIN, including but not limited to any patent right, copyright, mask work right, or other intellectual property right relating to any combination, machine, or process in which TI products or services are used. Information regarding or referencing third-party products or services does not constitute a license to use such products or services, or a warranty or endorsement thereof. Use of TI Resources may require a license from a third party under the patents or other intellectual property of the third party, or a license from TI under the patents or other intellectual property of TI.

TI RESOURCES ARE PROVIDED "AS IS" AND WITH ALL FAULTS. TI DISCLAIMS ALL OTHER WARRANTIES OR REPRESENTATIONS, EXPRESS OR IMPLIED, REGARDING RESOURCES OR USE THEREOF, INCLUDING BUT NOT LIMITED TO ACCURACY OR COMPLETENESS, TITLE, ANY EPIDEMIC FAILURE WARRANTY AND ANY IMPLIED WARRANTIES OF MERCHANTABILITY, FITNESS FOR A PARTICULAR PURPOSE, AND NON-INFRINGEMENT OF ANY THIRD PARTY INTELLECTUAL PROPERTY RIGHTS. TI SHALL NOT BE LIABLE FOR AND SHALL NOT DEFEND OR INDEMNIFY DESIGNER AGAINST ANY CLAIM, INCLUDING BUT NOT LIMITED TO ANY INFRINGEMENT CLAIM THAT RELATES TO OR IS BASED ON ANY COMBINATION OF PRODUCTS EVEN IF DESCRIBED IN TI RESOURCES OR OTHERWISE. IN NO EVENT SHALL TI BE LIABLE FOR ANY ACTUAL, DIRECT, SPECIAL, COLLATERAL, INDIRECT, PUNITIVE, INCIDENTAL, CONSEQUENTIAL OR EXEMPLARY DAMAGES IN CONNECTION WITH OR ARISING OUT OF TI RESOURCES OR USE THEREOF, AND REGARDLESS OF WHETHER TI HAS BEEN ADVISED OF THE POSSIBILITY OF SUCH DAMAGES.

Unless TI has explicitly designated an individual product as meeting the requirements of a particular industry standard (e.g., ISO/TS 16949 and ISO 26262), TI is not responsible for any failure to meet such industry standard requirements.

Where TI specifically promotes products as facilitating functional safety or as compliant with industry functional safety standards, such products are intended to help enable customers to design and create their own applications that meet applicable functional safety standards and requirements. Using products in an application does not by itself establish any safety features in the application. Designers must ensure compliance with safety-related requirements and standards applicable to their applications. Designer may not use any TI products in life-critical medical equipment unless authorized officers of the parties have executed a special contract specifically governing such use. Life-critical medical equipment is medical equipment where failure of such equipment would cause serious bodily injury or death (e.g., life support, pacemakers, defibrillators, heart pumps, neurostimulators, and implantables). Such equipment includes, without limitation, all medical devices identified by the U.S. Food and Drug Administration as Class III devices and equivalent classifications outside the U.S.

TI may expressly designate certain products as completing a particular qualification (e.g., Q100, Military Grade, or Enhanced Product). Designers agree that it has the necessary expertise to select the product with the appropriate qualification designation for their applications and that proper product selection is at Designers' own risk. Designers are solely responsible for compliance with all legal and regulatory requirements in connection with such selection.

Designer will fully indemnify TI and its representatives against any damages, costs, losses, and/or liabilities arising out of Designer's non-compliance with the terms and provisions of this Notice.