

4-17V 3A Step-Down Converter with DCS-Control™

Check for Samples: [TLV62130](#), [TLV62130A](#)

FEATURES

- DCS-Control™ Topology
- Input Voltage Range: 4 to 17V
- Up to 3A Output Current
- Adjustable Output Voltage from 0.9 to 5V
- Pin-Selectable Output Voltage (nominal, + 5%)
- Programmable Soft Start and Tracking
- Seamless Power Save Mode Transition
- Quiescent Current of 19µA (typ.)
- Selectable Operating Frequency
- Power Good Output
- 100% Duty Cycle Mode
- Short Circuit Protection
- Over Temperature Protection
- For Improved Feature Set, see [TPS62130](#)
- Available in a 3 × 3 mm, QFN-16 Package

APPLICATIONS

- Standard 12V Rail Supplies
- POL Supply from Single or Multiple Li-Ion Battery
- Embedded Systems
- LDO replacement
- Mobile PC's, Tablet, Modems, Cameras

DESCRIPTION

The TLV62130 is an easy to use synchronous step down DC-DC converter optimized for applications with high power density. A high switching frequency of typically 2.5MHz allows the use of small inductors and provides fast transient response as well as high output voltage accuracy by utilization of the DCS-Control™ topology.

With its wide operating input voltage range of 4V to 17V, the devices are ideally suited for systems powered from either a Li-Ion or other batteries as well as from 12V intermediate power rails. It supports up to 3A continuous output current at output voltages between 0.9V and 5V (with 100% duty cycle mode).

The output voltage startup ramp is controlled by the soft-start pin, which allows operation as either a standalone power supply or in tracking configurations. Power sequencing is also possible by configuring the Enable and open-drain Power Good pins.

In Power Save Mode, the devices show quiescent current of about 19µA from VIN. Power Save Mode, entered automatically and seamlessly if load is small, maintains high efficiency over the entire load range. In Shutdown Mode, the device is turned off and shutdown current consumption is less than 2µA.

The device is packaged in a 16-pin QFN package measuring 3 × 3 mm (RGT).

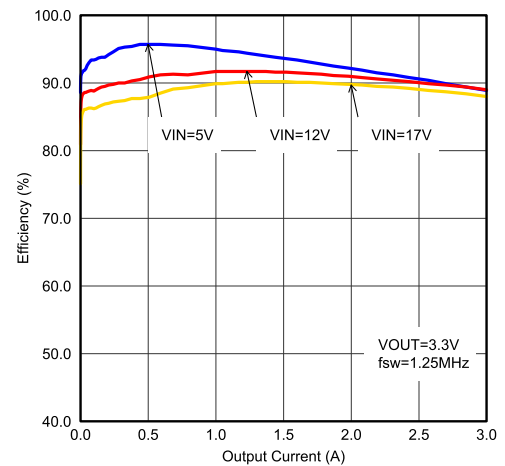
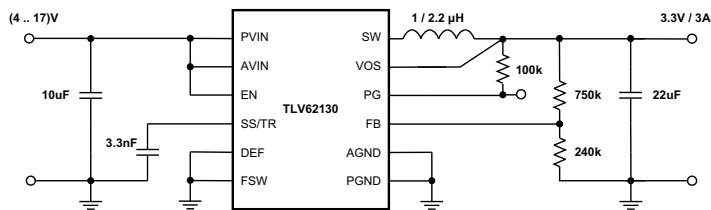

Figure 1. Typical Application and Efficiency



Please be aware that an important notice concerning availability, standard warranty, and use in critical applications of Texas Instruments semiconductor products and disclaimers thereto appears at the end of this data sheet.

DCS-Control is a trademark of Texas Instruments.

PRODUCTION DATA information is current as of publication date. Products conform to specifications per the terms of the Texas Instruments standard warranty. Production processing does not necessarily include testing of all parameters.

Copyright © 2012–2013, Texas Instruments Incorporated



These devices have limited built-in ESD protection. The leads should be shorted together or the device placed in conductive foam during storage or handling to prevent electrostatic damage to the MOS gates.

ORDERING INFORMATION⁽¹⁾

| T _A | OUTPUT VOLTAGE | PART NUMBER ⁽²⁾ | PACKAGE | ORDERING | PACKAGE MARKING |
|----------------|----------------|----------------------------|------------|--------------|-----------------|
| -40°C to 85°C | adjustable | TLV62130 | 16-Pin QFN | TLV62130RGT | VUBI |
| | adjustable | TLV62130A ⁽³⁾ | 16-Pin QFN | TLV62130ARGT | VUNI |

- (1) For detailed ordering information please check the PACKAGE OPTION ADDENDUM section at the end of this datasheet.
- (2) Contact the factory to check availability of other fixed output voltage versions.
- (3) While TLV62130 has PG=High Z, TLV62130A features PG=Low, when device is in shutdown through EN, UVLO or Thermal Shutdown.

ABSOLUTE MAXIMUM RATINGS⁽¹⁾

over operating free-air temperature range (unless otherwise noted)

| | | MIN | MAX | UNIT |
|----------------------------------|--|------|----------------------|------|
| Pin voltage range ⁽²⁾ | AVIN, PVIN | -0.3 | 20 | V |
| | EN, SS/TR | -0.3 | V _{IN} +0.3 | |
| | SW | -0.3 | V _{IN} +0.3 | V |
| | DEF, FSW, FB, PG, VOS | -0.3 | 7 | V |
| Power Good sink current | PG | | 10 | mA |
| Temperature range | Operating junction temperature range, T _J | -40 | 125 | °C |
| | Storage temperature range, T _{stg} | -65 | 150 | |
| ESD rating ⁽³⁾ | HBM Human body model | | 2 | kV |
| | CDM Charge device model | | 0.5 | kV |

- (1) Stresses beyond those listed under *absolute maximum ratings* may cause permanent damage to the device. These are stress ratings only, and functional operation of the device at these or any other conditions beyond those indicated under *recommended operating conditions* is not implied. Exposure to absolute-maximum-rated conditions for extended periods may affect device reliability.
- (2) All voltages are with respect to network ground terminal.
- (3) ESD testing is performed according to the respective JESD22 JEDEC standard.

THERMAL INFORMATION

| THERMAL METRIC ⁽¹⁾ | | TLV62130 | UNITS |
|-------------------------------|--|-------------|-------|
| | | RGT 16 PINS | |
| θ _{JA} | Junction-to-ambient thermal resistance | 29.1 | °C/W |
| θ _{JC(TOP)} | Junction-to-case(top) thermal resistance | 15 | |
| θ _{JB} | Junction-to-board thermal resistance | 11 | |
| ψ _{JT} | Junction-to-top characterization parameter | 0.5 | |
| ψ _{JB} | Junction-to-board characterization parameter | 10 | |
| θ _{JC(BOTTOM)} | Junction-to-case(bottom) thermal resistance | 3.5 | |

- (1) For more information about traditional and new thermal metrics, see the *IC Package Thermal Metrics* application report, [SPRA953](#).

RECOMMENDED OPERATING CONDITIONS

| | MIN | TYP | MAX | UNIT |
|--|-----|-----|-----|------|
| Supply Voltage, V _{IN} (at AVIN and PVIN) | 4 | | 17 | V |
| Operating free air temperature, T _A | -40 | | 85 | °C |
| Operating junction temperature, T _J | -40 | | 125 | °C |

ELECTRICAL CHARACTERISTICS

 over free-air temperature range ($T_A = -40^{\circ}\text{C}$ to $+85^{\circ}\text{C}$), typical values at $V_{IN} = 12\text{V}$ and $T_A = 25^{\circ}\text{C}$ (unless otherwise noted)

| PARAMETER | | TEST CONDITIONS | MIN | TYP | MAX | UNIT |
|--|--|--|------|---------|------|--------------------|
| SUPPLY | | | | | | |
| V_{IN} | Input voltage range ⁽¹⁾ | | 4 | | 17 | V |
| I_Q | Operating quiescent current | EN=High, $I_{OUT} = 0\text{mA}$, device not switching | | 19 | 27 | μA |
| I_{SD} | Shutdown current ⁽²⁾ | EN=Low | | 1.5 | 4 | μA |
| V_{UVLO} | Undervoltage lockout threshold | Falling Input Voltage | 2.6 | 2.7 | 2.8 | V |
| | | Hysteresis | | 200 | | mV |
| T_{SD} | Thermal shutdown temperature | | | 160 | | $^{\circ}\text{C}$ |
| | Thermal shutdown hysteresis | | | 20 | | |
| CONTROL (EN, DEF, FSW, SS/TR, PG) | | | | | | |
| V_H | High level input threshold voltage (EN, DEF, FSW) | | 0.9 | | | V |
| V_L | Low level input threshold voltage (EN, DEF, FSW) | | | | 0.3 | V |
| I_{LKG} | Input leakage current (EN, DEF, FSW) | EN= V_{IN} or GND; DEF, FSW= V_{OUT} or GND | | 0.01 | 1 | μA |
| V_{TH_PG} | Power good threshold voltage | Rising (% V_{OUT}) | 92 | 95 | 98 | % |
| | | Falling (% V_{OUT}) | 87 | 90 | 94 | |
| V_{OL_PG} | Power good output low | $I_{PG} = -2\text{mA}$ | | 0.07 | 0.3 | V |
| I_{LKG_PG} | Input leakage current (PG) | $V_{PG} = 1.8\text{V}$ | | 1 | 400 | nA |
| $I_{SS/TR}$ | SS/TR pin source current | | 2.3 | 2.5 | 2.7 | μA |
| POWER SWITCH | | | | | | |
| $R_{DS(ON)}$ | High-side MOSFET ON-resistance | $V_{IN} \geq 6\text{V}$ | | 90 | | m Ω |
| | Low-side MOSFET ON-resistance | $V_{IN} \geq 6\text{V}$ | | 40 | | m Ω |
| I_{LIMF} | High-side MOSFET forward current limit ⁽³⁾ | $V_{IN} = 12\text{V}$, $T_A = 25^{\circ}\text{C}$ | 3.6 | 4.2 | | A |
| OUTPUT | | | | | | |
| V_{REF} | Internal reference voltage ⁽⁴⁾ | | | 0.8 | | V |
| I_{LKG_FB} | Input leakage current (FB) | $V_{FB} = 0.8\text{V}$ | | 1 | 100 | nA |
| V_{OUT} | Output voltage range | $V_{IN} \geq V_{OUT}$ | 0.9 | | 5.0 | V |
| | DEF (Output voltage programming) | DEF=0 (GND) | | VOUT | | |
| | | DEF=1 (V_{OUT}) | | VOUT+5% | | |
| | Initial output voltage accuracy ⁽⁵⁾ | PWM mode operation, $V_{IN} \geq V_{OUT} + 1\text{V}$ | -2.5 | | 2.5 | % |
| | Load regulation ⁽⁶⁾ | $V_{IN} = 12\text{V}$, $V_{OUT} = 3.3\text{V}$, PWM mode operation | | | 0.05 | %/A |
| Line regulation ⁽⁶⁾ | $4\text{V} \leq V_{IN} \leq 17\text{V}$, $V_{OUT} = 3.3\text{V}$, $I_{OUT} = 1\text{A}$, PWM mode operation | | | 0.02 | %/V | |

(1) The device is still functional down to Under Voltage Lockout (see parameter V_{UVLO}).

(2) Current into AVIN+PVIN pin.

(3) This is the static current limit. It can be temporarily higher in applications due to internal propagation delay (see [Current Limit And Short Circuit Protection](#) section).

(4) This is the voltage regulated at the FB pin.

(5) This is the accuracy provided by the device itself (line and load regulation effects are not included).

(6) Line and load regulation depend on external component selection and layout (see [Figure 16](#) and [Figure 17](#)).

DEVICE INFORMATION

**RGT PACKAGE
(TOP VIEW)**

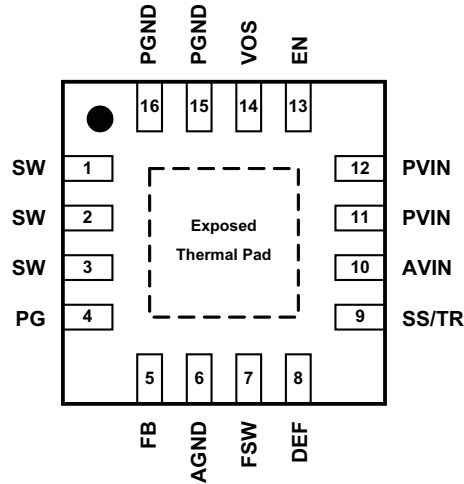

Terminal Functions

| PIN ⁽¹⁾ | | I/O | DESCRIPTION |
|---------------------|-------|-----|---|
| NAME | NO. | | |
| SW | 1,2,3 | O | Switch node, which is connected to the internal MOSFET switches. Connect inductor between SW and output capacitor. |
| PG | 4 | O | Output power good (High = VOUT ready, Low = VOUT below nominal regulation) ; open drain (requires pull-up resistor; goes high impedance, when device is switched off) |
| FB | 5 | I | Voltage feedback. Connect resistive voltage divider to this pin. |
| AGND | 6 | | Analog Ground. Must be connected directly to the Exposed Thermal Pad and common ground plane. |
| FSW | 7 | I | Switching Frequency Select (Low \approx 2.5MHz, High \approx 1.25MHz ⁽²⁾ for typical operation) ⁽³⁾ |
| DEF | 8 | I | Output Voltage Scaling (Low = nominal, High = nominal + 5%) ⁽³⁾ |
| SS/TR | 9 | I | Soft-Start / Tracking Pin. An external capacitor connected to this pin sets the internal voltage reference rise time. It can be used for tracking and sequencing. |
| AVIN | 10 | I | Supply voltage for control circuitry. Connect to same source as PVIN. |
| PVIN | 11,12 | I | Supply voltage for power stage. Connect to same source as AVIN. |
| EN | 13 | I | Enable input (High = enabled, Low = disabled) ⁽³⁾ |
| VOS | 14 | I | Output voltage sense pin and connection for the control loop circuitry. |
| PGND | 15,16 | | Power ground. Must be connected directly to the Exposed Thermal Pad and common ground plane. |
| Exposed Thermal Pad | | | Must be connected to AGND (pin 6), PGND (pin 15,16) and common ground plane ⁽⁴⁾ . Must be connected to AGND. Must be soldered to achieve appropriate power dissipation and mechanical reliability. |

- (1) For more information about connecting pins, see [DETAILED DESCRIPTION](#) and [APPLICATION INFORMATION](#) sections.
- (2) Connect FSW to VOUT or PG in this case.
- (3) An internal pull-down resistor keeps logic level low, if pin is floating.
- (4) See recommended layout shown in [Figure 40](#).

FUNCTIONAL BLOCK DIAGRAM

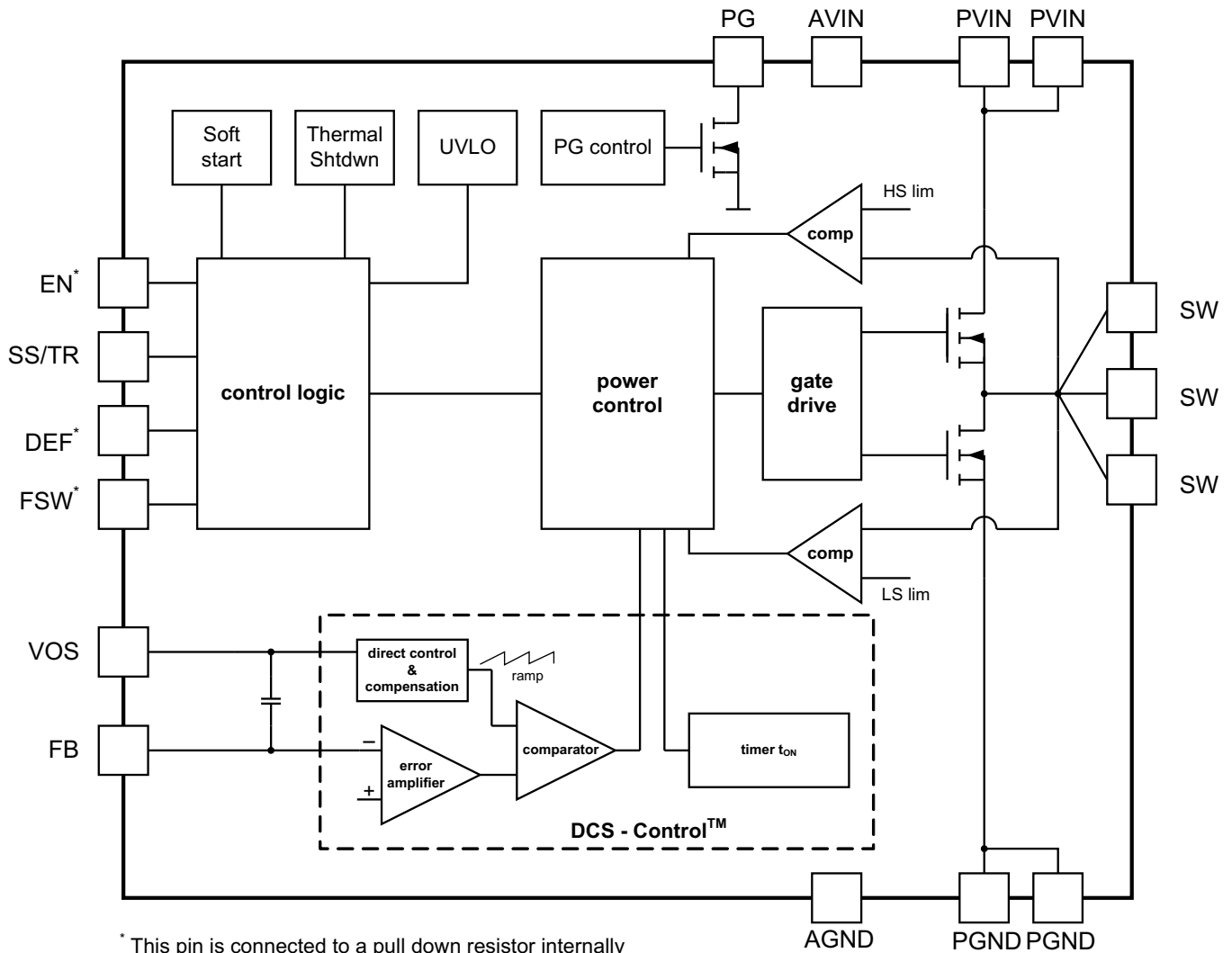

Figure 2. TLV62130

PARAMETER MEASUREMENT INFORMATION

List of Components

| REFERENCE | DESCRIPTION | MANUFACTURER |
|-----------|----------------------------------|--------------------------------|
| IC | 17V, 3A Step-Down Converter, QFN | TLV62130RGT, Texas Instruments |
| L1 | 2.2μH, 0.165 x 0.165 in | XFL4020-222MEB, Coilcraft |
| Cin | 10μF, 25V, Ceramic | Standard |
| Cout | 22μF, 6.3V, Ceramic | Standard |
| Cs | 3300pF, 25V, Ceramic | |
| R1 | depending on Vout | |
| R2 | depending on Vout | |
| R3 | 100kΩ, Chip, 0603, 1/16W, 1% | Standard |

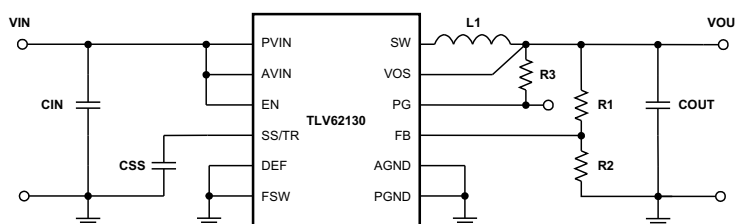

Figure 3. Measurement Setup

TYPICAL CHARACTERISTICS

Table of Graphs

| DESCRIPTION | | FIGURE |
|-------------------------------------|---|---------|
| Efficiency | vs Output Current, vs Input Voltage | 4 - 15 |
| Output voltage | vs Output current (Load regulation), vs Input Voltage (Line regulation) | 16, 17 |
| Switching Frequency | vs Input Voltage | 18 |
| | vs Output Current | 19 |
| Quiescent Current | vs Input Voltage | 20 |
| Shutdown Current | vs Input Voltage | 21 |
| Power FET RDS(on) | vs Input Voltage (High-Side, Low-Side) | 22, 23 |
| Output Voltage Ripple | vs output Current | 24 |
| Maximum Output Current | vs Input Voltage | 25 |
| Power Supply Rejection Ratio (PSSR) | vs Frequency | 26, 27 |
| Waveforms | PWM-PSM-PWM Mode Transition | 28 |
| | Load Transient Response | 29 - 31 |
| | Startup | 32, 33 |
| | Typical PWM Mode Operation | 34 |
| | Typical Power Save Mode Operation | 35 |
| Maximum Ambient Temperature | vs Load Current | 36 |
| | vs Power Dissipation | 37 |

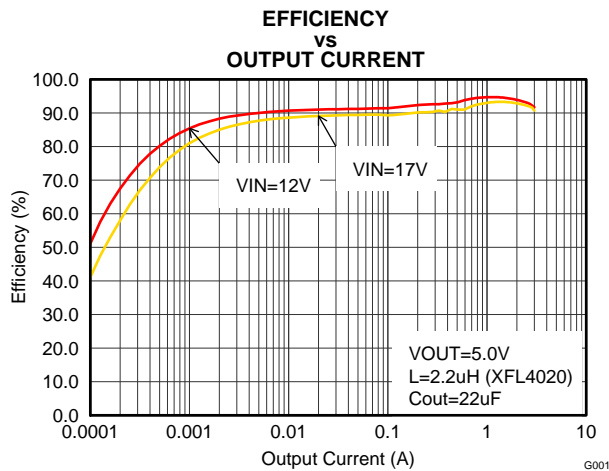

Figure 4. Efficiency with 1.25MHz, Vout=5V

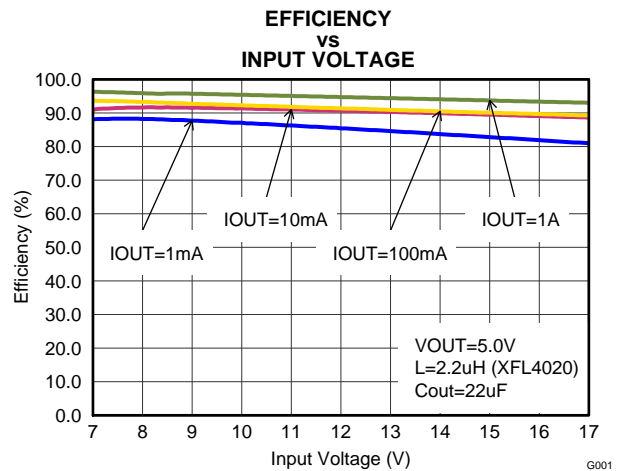

Figure 5. Efficiency with 1.25MHz, Vout=5V

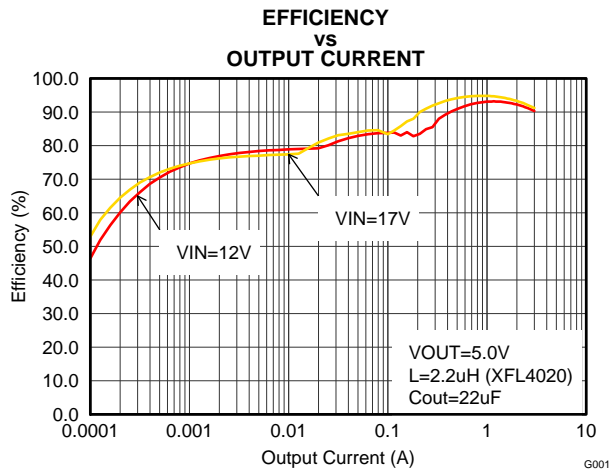

Figure 6. Efficiency with 2.5MHz, Vout=5V

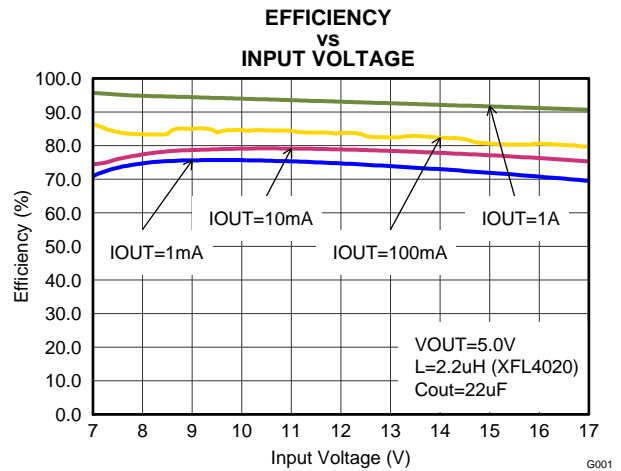

Figure 7. Efficiency with 2.5MHz, Vout=5V

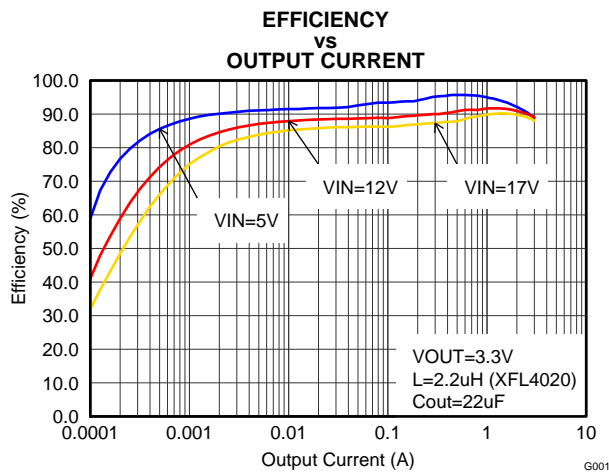

Figure 8. Efficiency with 1.25MHz, Vout=3.3V

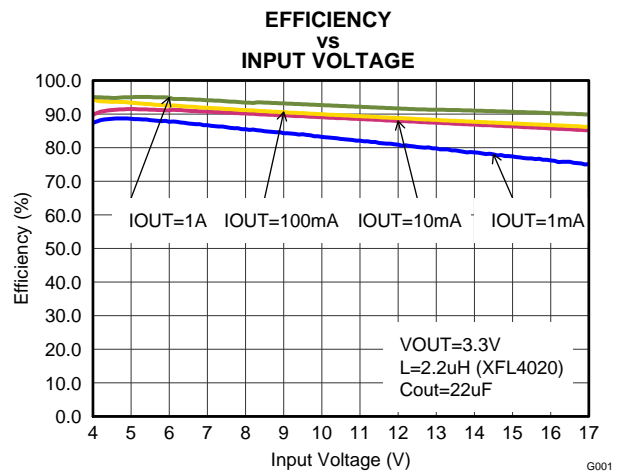

Figure 9. Efficiency with 1.25MHz, Vout=3.3V

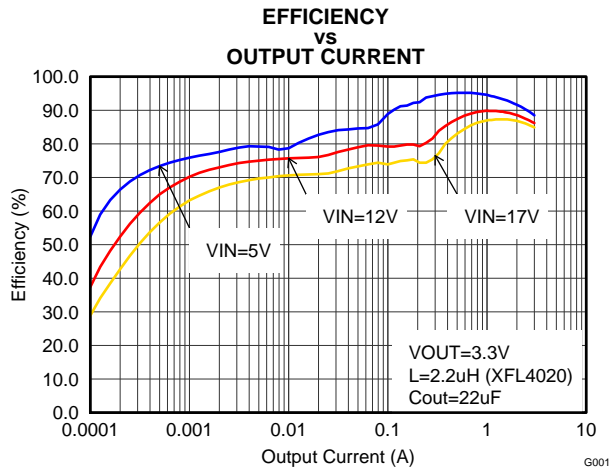

Figure 10. Efficiency with 2.5MHz, Vout=3.3V

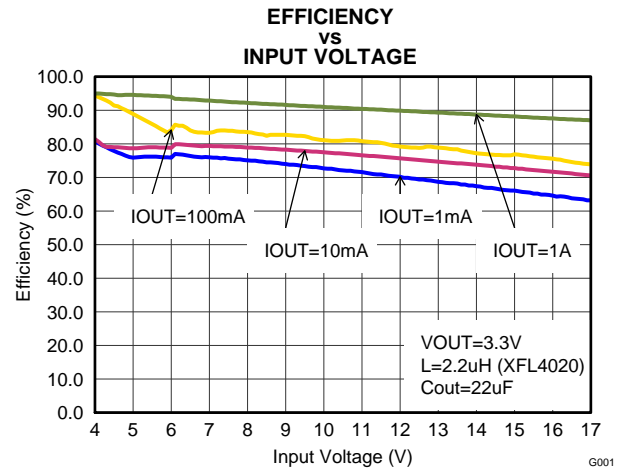

Figure 11. Efficiency with 2.5MHz, Vout=3.3V

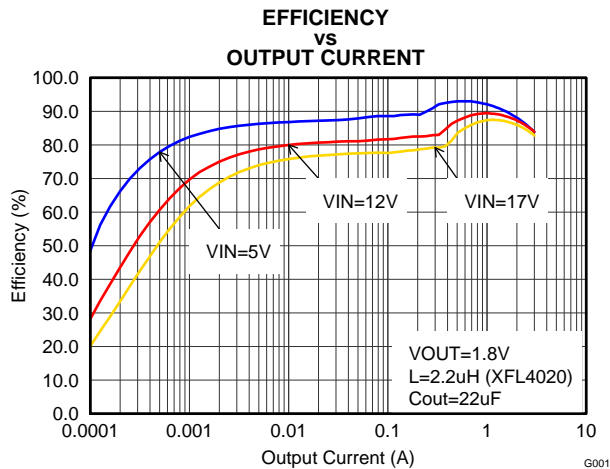

Figure 12. Efficiency with 1.25MHz, Vout=1.8V

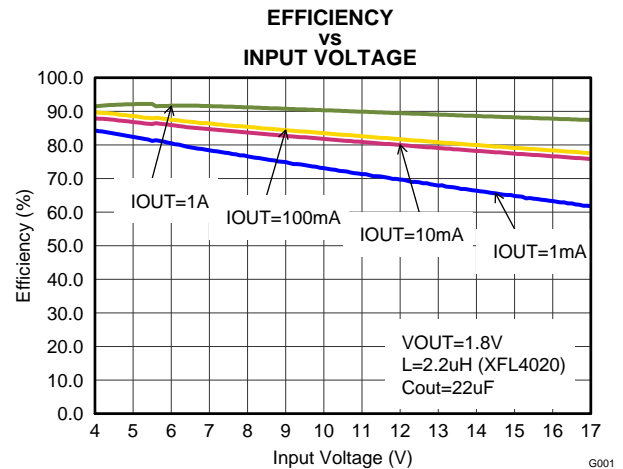

Figure 13. Efficiency with 1.25MHz, Vout=1.8V

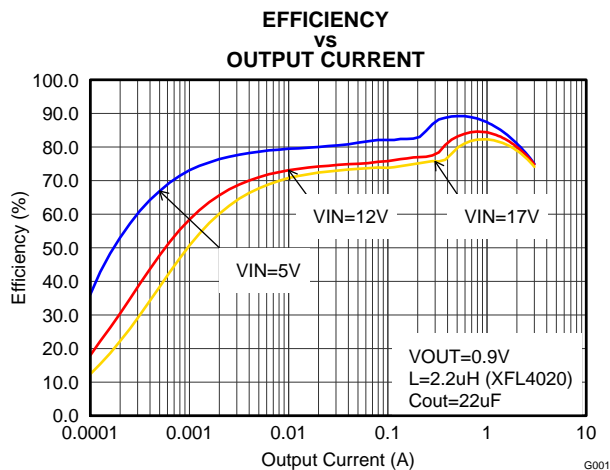

Figure 14. Efficiency with 1.25MHz, Vout=0.9V

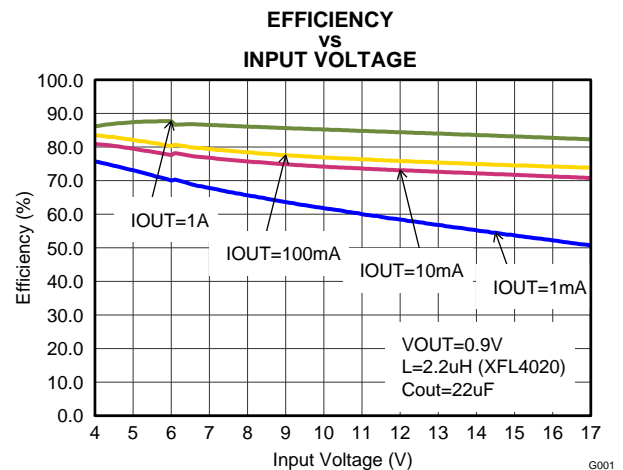

Figure 15. Efficiency with 1.25MHz, Vout=0.9V

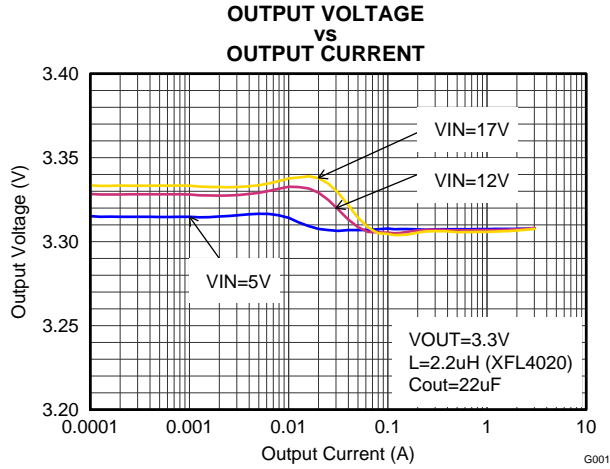

Figure 16. Output Voltage Accuracy (Load Regulation)

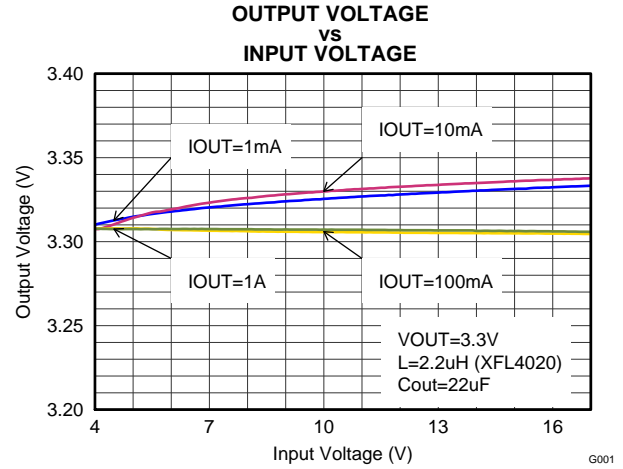

Figure 17. Output Voltage Accuracy (Line Regulation)

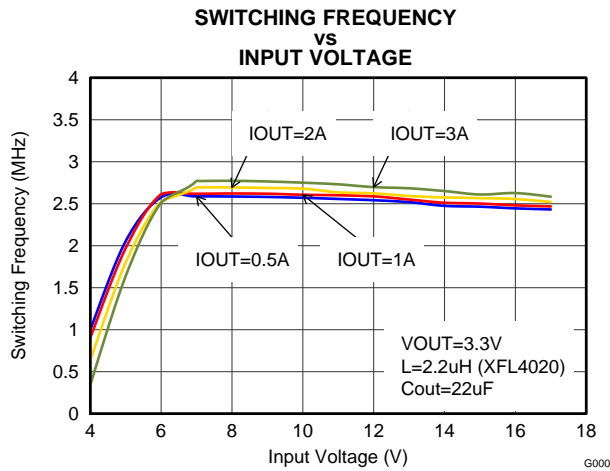

Figure 18. Switching Frequency

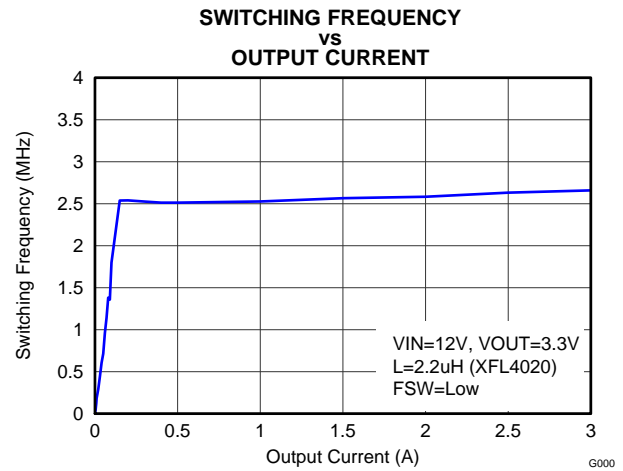

Figure 19. Switching Frequency

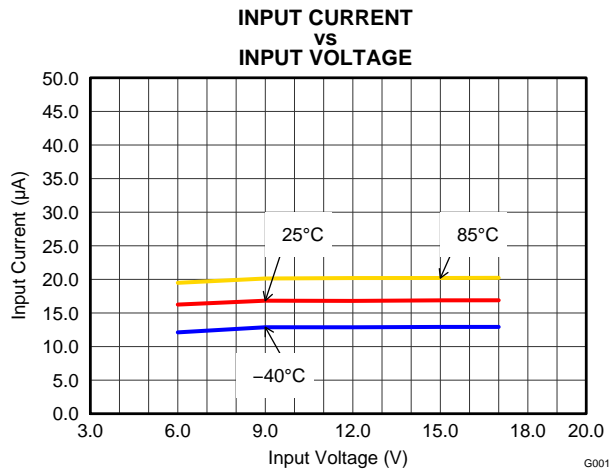

Figure 20. Quiescent Current

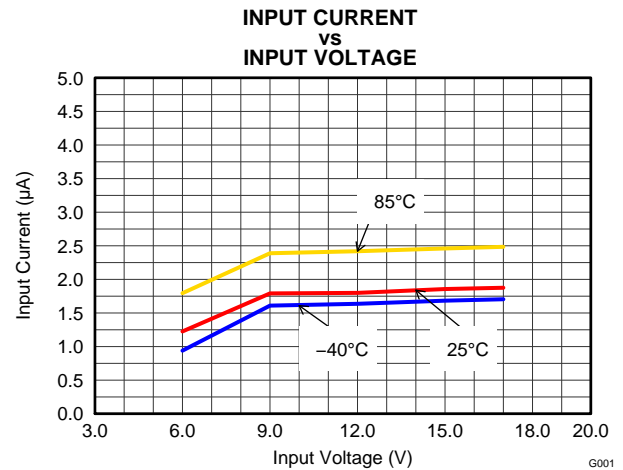

Figure 21. Shutdown Current

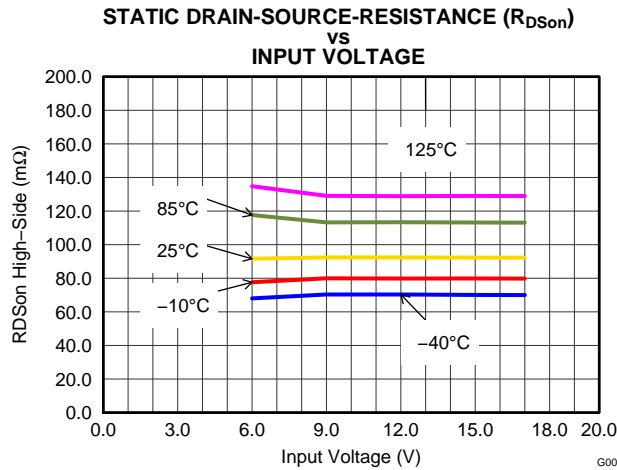

Figure 22. High-Side Switch Resistance

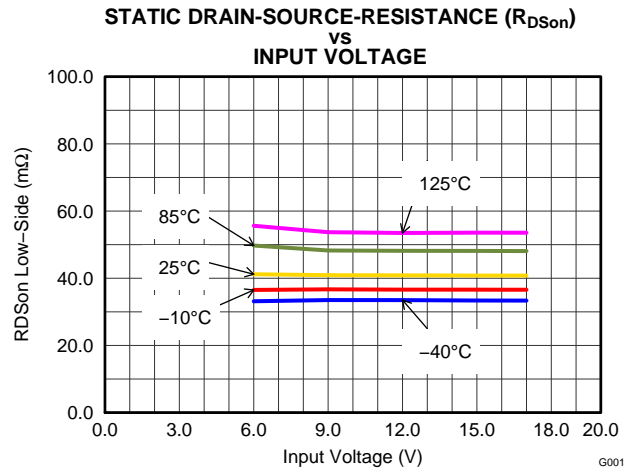

Figure 23. Low-Side Switch Resistance

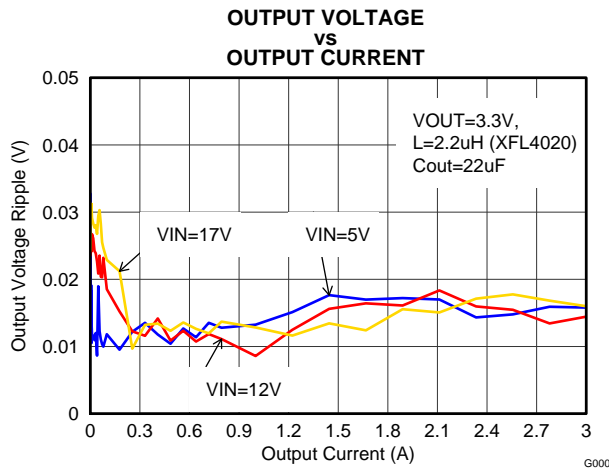

Figure 24. Output Voltage Ripple

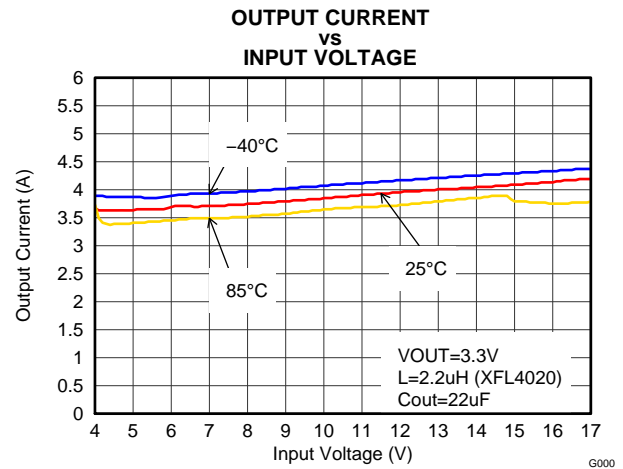

Figure 25. Maximum Output Current

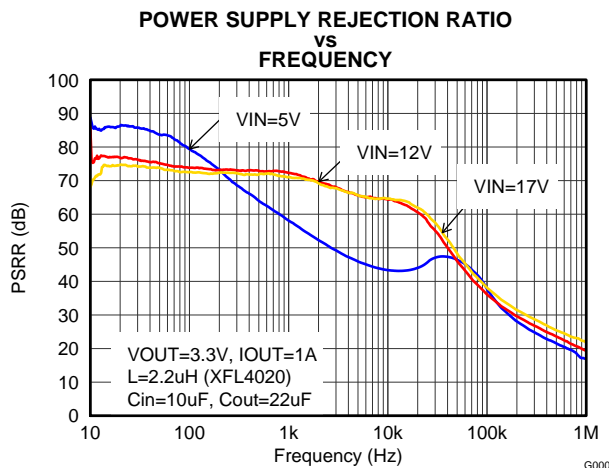

Figure 26. Power Supply Rejection Ratio, $f_{SW}=2.5\text{MHz}$

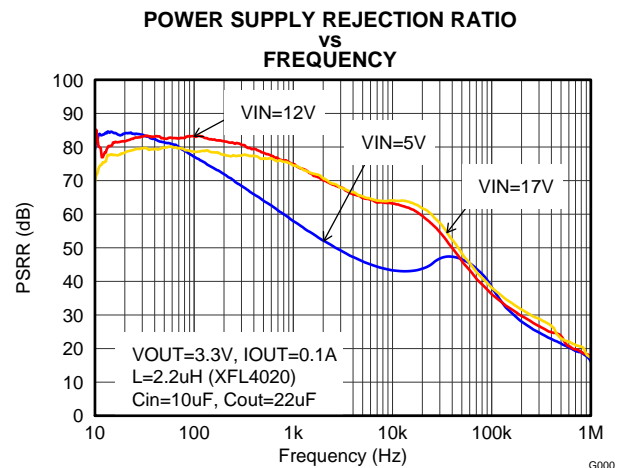

Figure 27. Power Supply Rejection Ratio, $f_{SW}=2.5\text{MHz}$

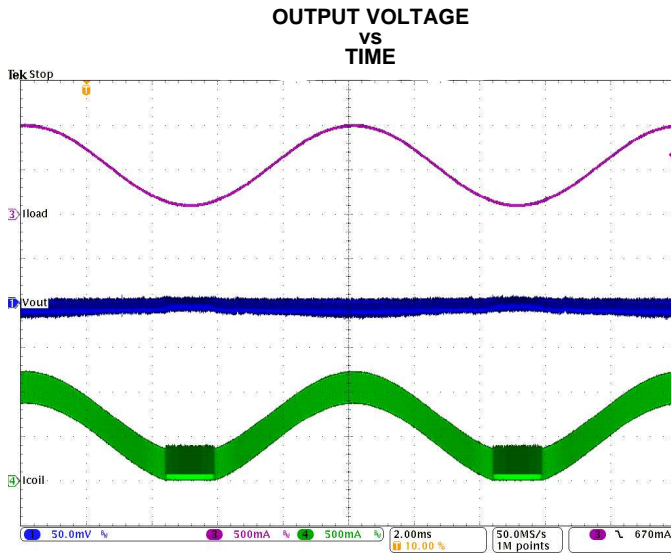

Figure 28. PWM-PSM-Transition ($V_{IN}=12V$, $V_{OUT}=3.3V$ with 50mV/div)

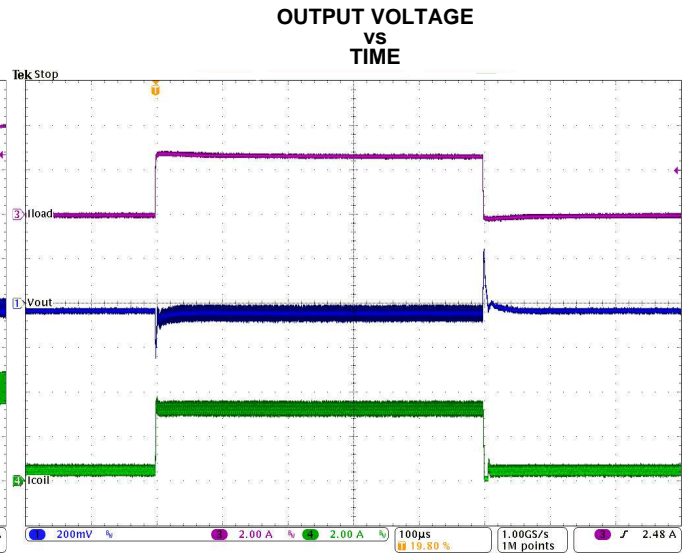

Figure 29. Load Transient Response ($I_{OUT}= 0.5$ to 3 to 0.5 A, $V_{IN}=12V$, $V_{OUT}=3.3V$)

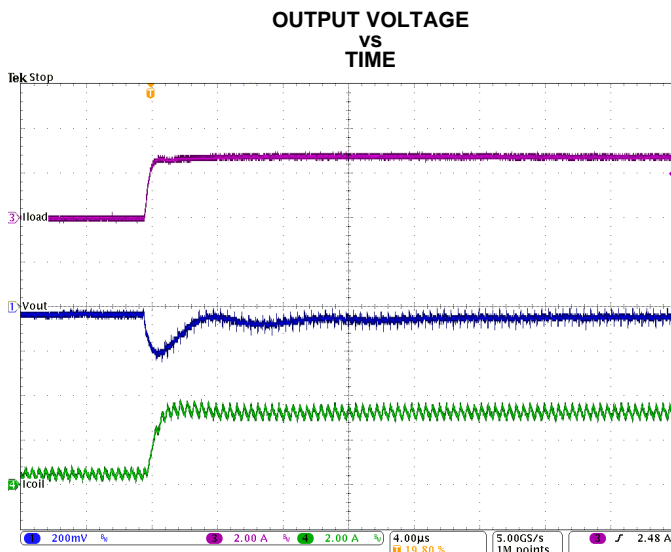

Figure 30. Load Transient Response of Figure 29, rising edge

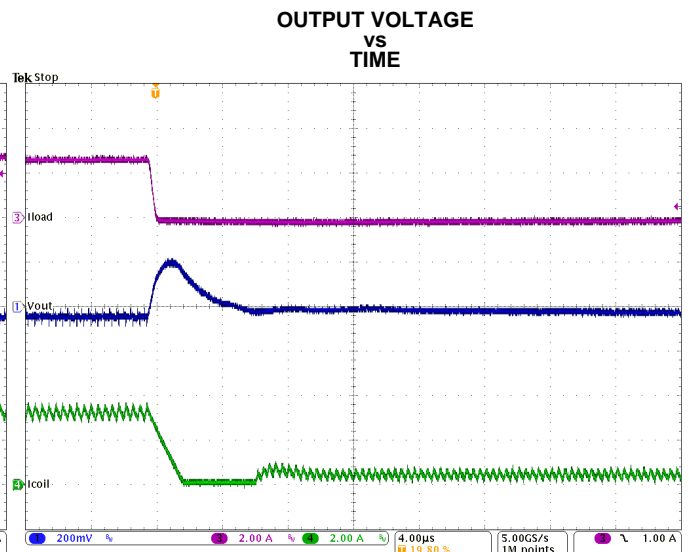

Figure 31. Load Transient Response of Figure 29, falling edge

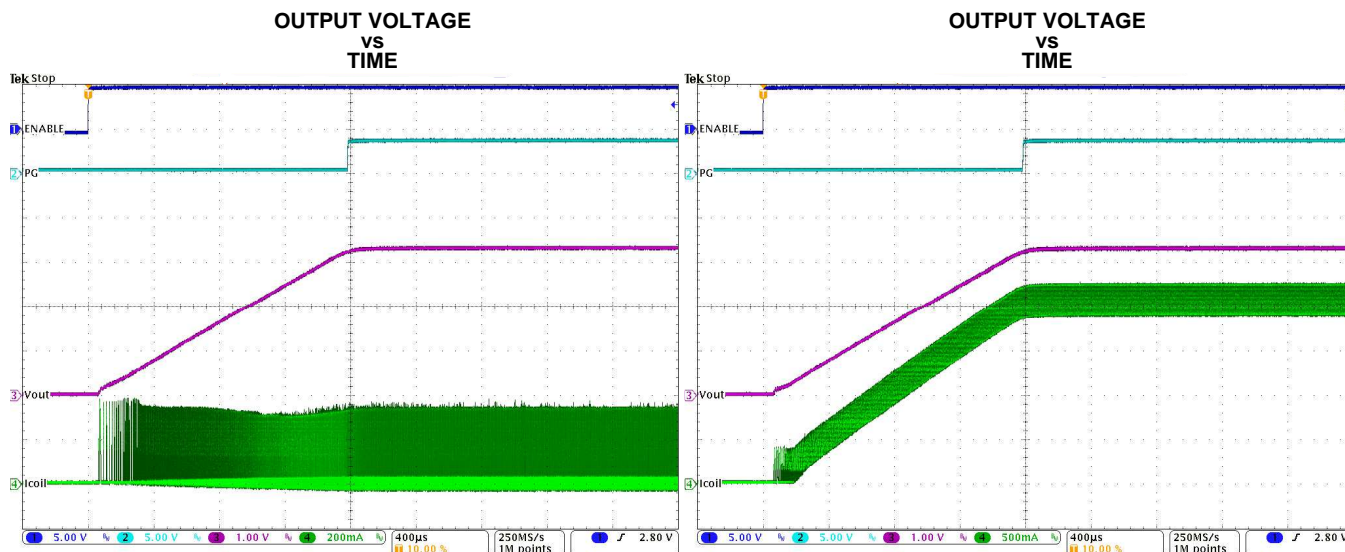

Figure 32. Startup into 100mA (VIN=12V, VOUT=3.3V)

Figure 33. Startup into 3A (VIN=12V, VOUT=3.3V)

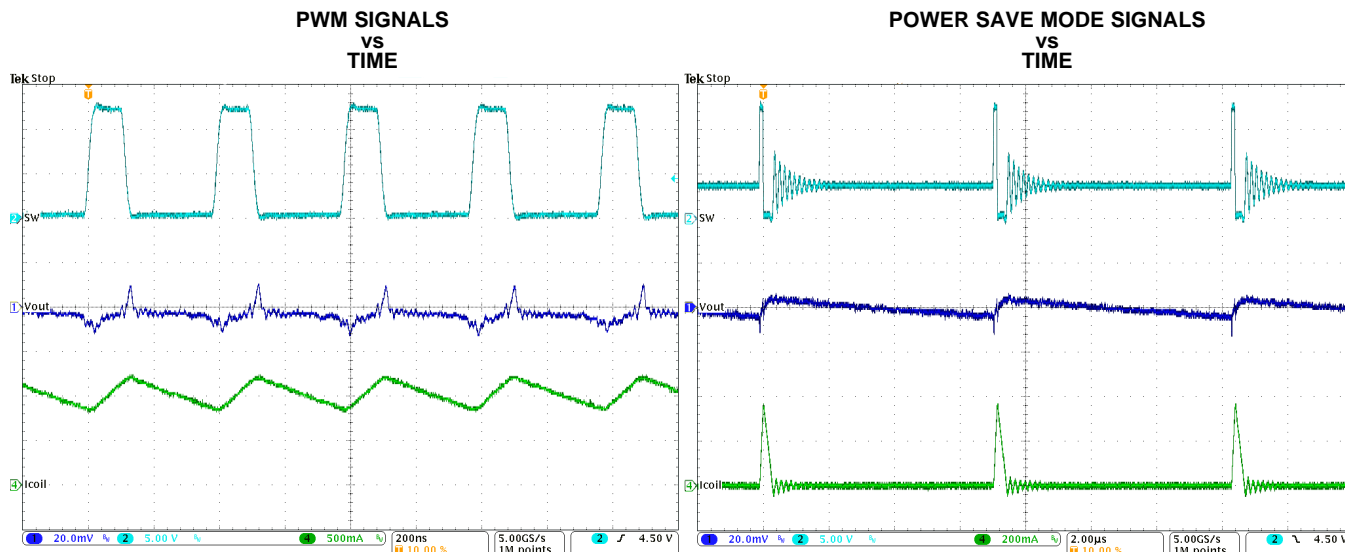

Figure 34. Typical Operation in PWM Mode (I_{OUT}=1A)

Figure 35. Typical Operation in Power Save Mode (I_{OUT}=10mA)

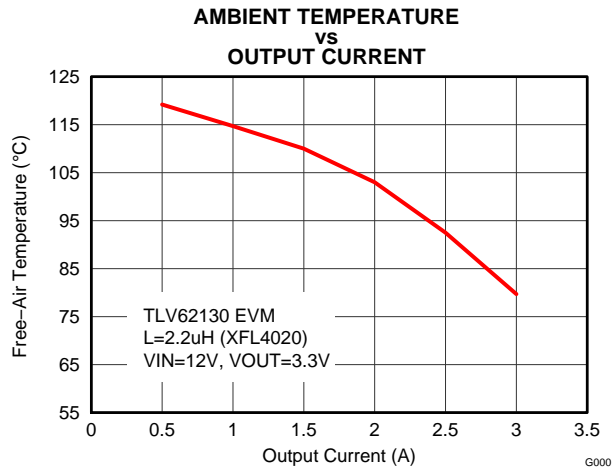

Figure 36. Maximum Ambient Temperature ($f_{SW}=2.5\text{MHz}$)

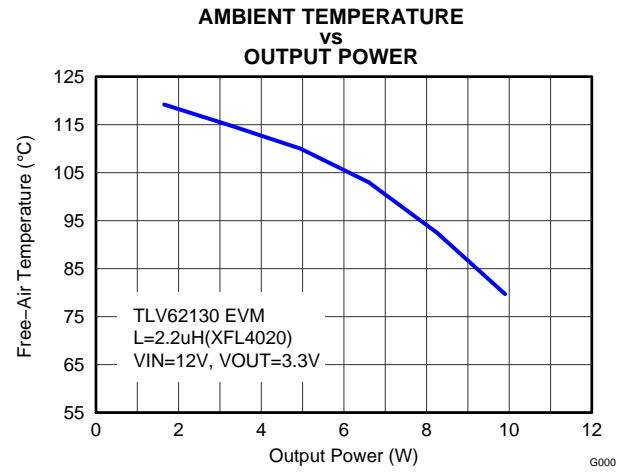

Figure 37. Maximum Ambient Temperature ($f_{SW}=2.5\text{MHz}$)

DETAILED DESCRIPTION

Device Operation

The TLV62130 synchronous switched mode power converters are based on DCS-Control™ (Direct Control with Seamless Transition into Power Save Mode), an advanced regulation topology, that combines the advantages of hysteretic, voltage mode and current mode control including an AC loop directly associated to the output voltage. This control loop takes information about output voltage changes and feeds it directly to a fast comparator stage. It sets the switching frequency, which is constant for steady state operating conditions, and provides immediate response to dynamic load changes. To get accurate DC load regulation, a voltage feedback loop is used. The internally compensated regulation network achieves fast and stable operation with small external components and low ESR capacitors.

The DCS-Control™ topology supports PWM (Pulse Width Modulation) mode for medium and heavy load conditions and a Power Save Mode at light loads. During PWM, it operates at its nominal switching frequency in continuous conduction mode. This frequency is typically about 2.5MHz with a controlled frequency variation depending on the input voltage. If the load current decreases, the converter enters Power Save Mode to sustain high efficiency down to very light loads. In Power Save Mode the switching frequency decreases linearly with the load current. Since DCS-Control™ supports both operation modes within one single building block, the transition from PWM to Power Save Mode is seamless without effects on the output voltage. An internal current limit supports nominal output currents of up to 3A.

The TLV62130 offers both excellent DC voltage and superior load transient regulation, combined with very low output voltage ripple, minimizing interference with RF circuits.

Pulse Width Modulation (PWM) Operation

The TLV62130 operates with pulse width modulation in continuous conduction mode (CCM) with a nominal switching frequency of 2.5 MHz or 1.25MHz, selectable with the FSW pin. The frequency variation in PWM is controlled and depends on V_{IN} , V_{OUT} and the inductance. The device operates in PWM mode as long the output current is higher than half the inductor's ripple current. To maintain high efficiency at light loads, the device enters Power Save Mode at the boundary to discontinuous conduction mode (DCM). This happens if the output current becomes smaller than half the inductor's ripple current.

Power Save Mode Operation

The TLV62130's built in Power Save Mode will be entered seamlessly, if the load current decreases. This secures a high efficiency in light load operation. The device remains in Power Save Mode as long as the inductor current is discontinuous.

In Power Save Mode the switching frequency decreases linearly with the load current maintaining high efficiency. The transition into and out of Power Save Mode happens within the entire regulation scheme and is seamless in both directions.

TLV62130 includes a fixed on-time circuitry. This on-time, in steady-state operation, can be estimated as:

$$t_{ON} = \frac{V_{OUT}}{V_{IN}} \cdot 400ns \quad (1)$$

For very small output voltages, an absolute minimum on-time of about 80ns is kept to limit switching losses. The operating frequency is thereby reduced from its nominal value, which keeps efficiency high. Using t_{ON} , the typical peak inductor current in Power Save Mode can be approximated by:

$$I_{LPSM(peak)} = \frac{(V_{IN} - V_{OUT})}{L} \cdot t_{ON} \quad (2)$$

When V_{IN} decreases to typically 15% above V_{OUT} , the TLV62130 won't enter Power Save Mode, regardless of the load current. The device maintains output regulation in PWM mode.

100% Duty-Cycle Operation

The duty cycle of the buck converter is given by $D=V_{out}/V_{in}$ and increases as the input voltage comes close to the output voltage. In this case, the device starts 100% duty cycle operation turning on the high-side switch 100% of the time. The high-side switch stays turned on as long as the output voltage is below the internal setpoint. This allows the conversion of small input to output voltage differences, e.g. for longest operation time of battery-powered applications. In 100% duty cycle mode, the low-side FET is switched off.

The minimum input voltage to maintain output voltage regulation, depending on the load current and the output voltage level, can be calculated as:

$$V_{IN(min)} = V_{OUT(min)} + I_{OUT} (R_{DS(on)} + R_L) \quad (3)$$

where

I_{OUT} is the output current,

$R_{DS(on)}$ is the $R_{DS(on)}$ of the high-side FET and

R_L is the DC resistance of the inductor used.

Enable / Shutdown (EN)

When Enable (EN) is set High, the device starts operation. Shutdown is forced if EN is pulled Low with a shutdown current of typically 1.5µA. During shutdown, the internal power MOSFETs as well as the entire control circuitry are turned off. The internal resistive divider pulls down the output voltage smoothly. An internal pull-down resistor of about 400kΩ is connected and keeps EN logic low, if the pin is floating. It is disconnected if the pin is High.

Connecting the EN pin to an appropriate output signal of another power rail provides sequencing of multiple power rails.

Soft Start / Tracking (SS/TR)

The internal soft start circuitry controls the output voltage slope during startup. This avoids excessive inrush current and ensures a controlled output voltage rise time. It also prevents unwanted voltage drops from high-impedance power sources or batteries. When EN is set to start device operation, the device starts switching after a delay of about 50µs and VOUT rises with a slope controlled by an external capacitor connected to the SS/TR pin. See [Figure 32](#) and [Figure 33](#) for typical startup operation.

Connecting SS/TR directly to AVIN provides fastest startup behavior. The TLV62130 can start into a pre-biased output. During monotonic pre-biased startup, the low-side MOSFET is not allowed to turn on until the device's internal ramp sets an output voltage above the pre-bias voltage. As long as the output is below about 0.5V a reduced current limit of typically 1.6A is set internally. If the device is set to shutdown (EN=GND), undervoltage lockout or thermal shutdown, an internal resistor pulls the SS/TR pin down to ensure a proper low level. Returning from those states causes a new startup sequence as set by the SS/TR connection.

A voltage supplied to SS/TR can be used for tracking a master voltage. The output voltage will follow this voltage in both directions up and down (see [APPLICATION INFORMATION](#)).

Current Limit And Short Circuit Protection

The TLV62130 device is protected against heavy load and short circuit events. If a short circuit is detected (VOUT drops below 0.5V), the current limit is reduced to 1.6A typically. If the output voltage rises above 0.5V, the device will run in normal operation again. At heavy loads, the current limit determines the maximum output current. If the current limit is reached, the high-side FET will be turned off. Avoiding shoot through current, the low-side FET will be switched on to sink the inductor current. The high-side FET will turn on again, only if the current in the low-side FET has decreased below the low side current limit threshold.

The output current of the device is limited by the current limit (see [ELECTRICAL CHARACTERISTICS](#)). Due to internal propagation delay, the actual current can exceed the static current limit during that time. The dynamic current limit can be calculated as follows:

$$I_{peak(typ)} = I_{LIMF} + \frac{V_L}{L} \cdot t_{PD} \quad (4)$$

where

I_{LIMF} is the static current limit, specified in the [ELECTRICAL CHARACTERISTICS](#),

L is the inductor value,

V_L is the voltage across the inductor ($V_{IN} - V_{OUT}$) and

t_{PD} is the internal propagation delay.

The current limit can exceed static values, especially if the input voltage is high and very small inductances are used. The dynamic high side switch peak current can be calculated as follows:

$$I_{peak(typ)} = I_{LIMF} + \frac{(V_{IN} - V_{OUT})}{L} \cdot 30ns \quad (5)$$

Power Good (PG)

The TLV62130 has a built in power good (PG) function to indicate whether the output voltage has reached its appropriate level or not. The PG signal can be used for startup sequencing of multiple rails. The PG pin is an open-drain output that requires a pull-up resistor (to any voltage below 7V). It can sink 2mA of current and maintain its specified logic low level. It is high impedance when the device is turned off due to EN, UVLO or thermal shutdown. TLV62130A features PG=Low in this case and can be used to actively discharge Vout (see [Figure 50](#)). VIN must remain present for the PG pin to stay Low.

Pin-Selectable Output Voltage (DEF)

The output voltage of the TLV62130 devices can be increased by 5% above the nominal voltage by setting the DEF pin to High ⁽¹⁾. When DEF is Low, the device regulates to the nominal output voltage. Increasing the nominal voltage allows adapting the power supply voltage to the variations of the application hardware. More detailed information on voltage margining using TLV62130 can be found in [SLVA489](#). A pull down resistor of about 400kOhm is internally connected to the pin, to ensure a proper logic level if the pin is high impedance or floating after initially set to Low. The resistor is disconnected if the pin is set High.

Frequency Selection (FSW)

To get high power density with very small solution size, a high switching frequency allows the use of small external components for the output filter. However switching losses increase with the switching frequency. If efficiency is the key parameter, more than solution size, the switching frequency can be set to half (1.25 MHz typ.) by pulling FSW to High. It is mandatory to start with FSW=Low to limit inrush current, which can be done by connecting to VOUT or PG. Running with lower frequency a higher efficiency, but also a higher output voltage ripple, is achieved. Pull FSW to Low for high frequency operation (2.5 MHz typ.). To get low ripple and full output current at the lower switching frequency, it's recommended to use an inductor of at least 2.2uH. The switching frequency can be changed during operation, if needed. A pull down resistor of about 400kOhm is internally connected to the pin, acting the same way as at the DEF Pin (see above).

Under Voltage Lockout (UVLO)

If the input voltage drops, the under voltage lockout prevents misoperation of the device by switching off both the power FETs. The under voltage lockout threshold is set typically to 2.7V. The device is fully operational for voltages above the UVLO threshold and turns off if the input voltage trips the threshold. The converter starts operation again once the input voltage exceeds the threshold by a hysteresis of typically 200mV.

Thermal Shutdown

The junction temperature (Tj) of the device is monitored by an internal temperature sensor. If Tj exceeds 160°C (typ), the device goes into thermal shut down. Both the high-side and low-side power FETs are turned off and PG goes high impedance. When Tj decreases below the hysteresis amount, the converter resumes normal operation, beginning with Soft Start. To avoid unstable conditions, a hysteresis of typically 20°C is implemented on the thermal shut down temperature.

(1) Maximum allowed voltage is 7V. Therefore, it's recommended to connect it to VOUT or PG, not VIN.

APPLICATION INFORMATION

The following information is intended to be a guideline through the individual power supply design process.

Programming The Output Voltage

The TLV62130 can be programmed for output voltages from 0.9V to 5V by using a resistive divider from VOUT to AGND. The voltage at the FB pin is regulated to 800mV. The value of the output voltage is set by the selection of the resistive divider from Equation 6 (see Figure 3). It is recommended to choose resistor values which allow a current of at least 2µA, meaning the value of R2 shouldn't exceed 400kΩ. Lower resistor values are recommended for highest accuracy and most robust design.

$$R_1 = R_2 \left(\frac{V_{OUT}}{V_{REF}} - 1 \right) \quad (6)$$

In case the FB pin gets opened, the device clamps the output voltage at the VOS pin internally to about 7.4V.

External Component Selection

The external components have to fulfill the needs of the application, but also the stability criteria of the devices control loop. The TLV62130 is optimized to work within a range of external components. The LC output filters inductance and capacitance have to be considered together, creating a double pole, responsible for the corner frequency of the converter (see Output Filter And Loop Stability). Table 1 can be used to simplify the output filter component selection.

Table 1. Recommended LC Output Filter Combinations⁽¹⁾

| | 4.7µF | 10µF | 22µF | 47µF | 100µF | 200µF | 400µF |
|--------|-------|------|------------------|------|-------|-------|-------|
| 0.47µH | | | | | | | |
| 1µH | | | √ | √ | √ | √ | |
| 2.2µH | | √ | √ ⁽²⁾ | √ | √ | √ | |
| 3.3µH | | √ | √ | √ | √ | | |
| 4.7µH | | | | | | | |

(1) The values in the table are nominal values.

(2) This LC combination is the standard value and recommended for most applications.

The TLV62130 can be run with an inductor as low as 1µH. FSW should be set Low in this case. However, for applications running with the low frequency setting (FSW=High) or with low input voltages, 2.2µH is recommended. More detailed information on further LC combinations can be found in SLVA463.

Inductor Selection

The inductor selection is affected by several effects like inductor ripple current, output ripple voltage, PWM-to-PSM transition point and efficiency. In addition, the inductor selected has to be rated for appropriate saturation current and DC resistance (DCR). Equation 7 and Equation 8 calculate the maximum inductor current under static load conditions.

$$I_{L(max)} = I_{OUT(max)} + \frac{\Delta I_{L(max)}}{2} \quad (7)$$

$$\Delta I_{L(max)} = V_{OUT} \cdot \left(\frac{1 - \frac{V_{OUT}}{V_{IN(max)}}}{L_{(min)} \cdot f_{SW}} \right) \quad (8)$$

where

- $I_L(\text{max})$ is the maximum inductor current,
- ΔI_L is the Peak to Peak Inductor Ripple Current,
- $L(\text{min})$ is the minimum effective inductor value and
- f_{SW} is the actual PWM Switching Frequency.

Calculating the maximum inductor current using the actual operating conditions gives the minimum saturation current of the inductor needed. A margin of about 20% is recommended to add. A larger inductor value is also useful to get lower ripple current, but increases the transient response time and size as well. The following inductors have been used with the TLV62130 and are recommended for use:

Table 2. List of Inductors

| Type | Inductance [μH] | Current [A] ⁽¹⁾ | Dimensions [LxBxH] mm | MANUFACTURER |
|----------------|--------------------------------|----------------------------|--------------------------|--------------|
| XFL4020-102ME_ | 1.0 μH , $\pm 20\%$ | 4.7 | 4 x 4 x 2.1 | Coilcraft |
| XFL4020-152ME_ | 1.5 μH , $\pm 20\%$ | 4.2 | 4 x 4 x 2.1 | Coilcraft |
| XFL4020-222ME_ | 2.2 μH , $\pm 20\%$ | 3.8 | 4 x 4 x 2.1 | Coilcraft |
| IHLP1212BZ-11 | 1.0 μH , $\pm 20\%$ | 4.5 | 3 x 3.6 x 2 | Vishay |
| IHLP1212BZ-11 | 2.2 μH , $\pm 20\%$ | 3.0 | 3 x 3.6 x 2 | Vishay |
| SRP4020-3R3M | 3.3 μH , $\pm 20\%$ | 3.3 | 4.8 x 4 x 2 | Bourns |
| VLC5045T-3R3N | 3.3 μH , $\pm 30\%$ | 4.0 | 5 x 5 x 4.5 | TDK |

(1) Lower of I_{RMS} at 40°C rise or I_{SAT} at 30% drop.

The inductor value also determines the load current at which Power Save Mode is entered:

$$I_{\text{load}(PSM)} = \frac{1}{2} \Delta I_L \quad (9)$$

Using [Equation 8](#), this current level can be adjusted by changing the inductor value.

Capacitor Selection

Output Capacitor

The recommended value for the output capacitor is 22 μF . The architecture of the TLV62130 allows the use of tiny ceramic output capacitors with low equivalent series resistance (ESR). These capacitors provide low output voltage ripple and are recommended. To keep its low resistance up to high frequencies and to get narrow capacitance variation with temperature, it's recommended to use X7R or X5R dielectric. Using a higher value can have some advantages like smaller voltage ripple and a tighter DC output accuracy in Power Save Mode (see [SLVA463](#)).

Note: In power save mode, the output voltage ripple depends on the output capacitance, its ESR and the peak inductor current. Using ceramic capacitors provides small ESR and low ripple.

Input Capacitor

For most applications, 10 μF will be sufficient and is recommended, though a larger value reduces input current ripple further. The input capacitor buffers the input voltage for transient events and also decouples the converter from the supply. A low ESR multilayer ceramic capacitor is recommended for best filtering and should be placed between PVIN and PGND as close as possible to those pins. Even though AVIN and PVIN must be supplied from the same input source, it's required to place a capacitance of 0.1 μF from AVIN to AGND, to avoid potential noise coupling. An RC, low-pass filter from PVIN to AVIN may be used but is not required.

Soft Start Capacitor

A capacitance connected between SS/TR pin and AGND allows a user programmable start-up slope of the output voltage. A constant current source supports 2.5µA to charge the external capacitance. The capacitor required for a given soft-start ramp time for the output voltage is given by:

$$C_{SS} = t_{SS} \cdot \frac{2.5\mu A}{1.25V} [F] \quad (10)$$

where

C_{SS} is the capacitance (F) required at the SS/TR pin and
 t_{SS} is the desired soft-start ramp time (s).

NOTE

DC Bias effect: High capacitance ceramic capacitors have a DC Bias effect, which will have a strong influence on the final effective capacitance. Therefore the right capacitor value has to be chosen carefully. Package size and voltage rating in combination with dielectric material are responsible for differences between the rated capacitor value and the effective capacitance.

Tracking Function

If a tracking function is desired, the SS/TR pin can be used for this purpose by connecting it to an external tracking voltage. The output voltage tracks that voltage. If the tracking voltage is between 50mV and 1.2V, the FB pin will track the SS/TR pin voltage as described in [Equation 11](#) and shown in [Figure 38](#).

$$V_{FB} \approx 0.64 \cdot V_{SS/TR} \quad (11)$$

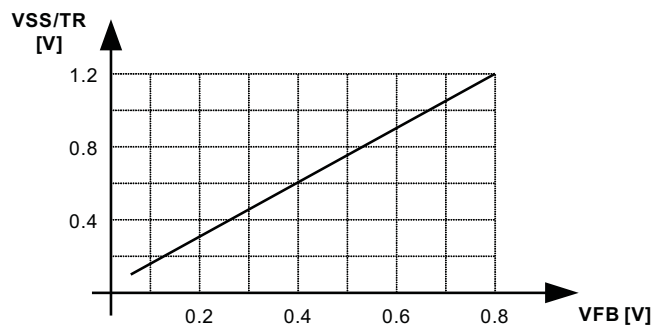

Figure 38. Voltage Tracking Relationship

Once the SS/TR pin voltage reaches about 1.2V, the internal voltage is clamped to the internal feedback voltage and device goes to normal regulation. This works for rising and falling tracking voltages with the same behavior, as long as the input voltage is inside the recommended operating conditions. For decreasing SS/TR pin voltage, the device doesn't sink current from the output. So, the resulting decrease of the output voltage may be slower than the SS/TR pin voltage if the load is light. When driving the SS/TR pin with an external voltage, do not exceed the voltage rating of the SS/TR pin which is $V_{IN}+0.3V$.

If the input voltage drops into undervoltage lockout or even down to zero, the output voltage will go to zero, independent of the tracking voltage. [Figure 39](#) shows how to connect devices to get ratiometric and simultaneous sequencing by using the tracking function.

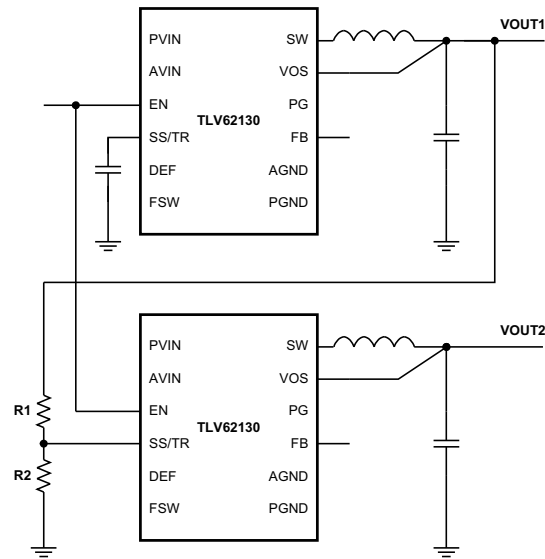

Figure 39. Sequence for Ratiometric and Simultaneous Startup

The resistive divider of R1 and R2 can be used to change the ramp rate of VOUT2 faster, slower or the same as VOUT1.

A sequential startup is achieved by connecting the PG pin of VOUT1 to the EN pin of VOUT2. Ratiometric start up sequence happens if both supplies are sharing the same soft start capacitor. Equation 10 calculates the soft start time, though the SS/TR current has to be doubled. Details about these and other tracking and sequencing circuits are found in SLVA470.

Note: If the voltage at the FB pin is below its typical value of 0.8V, the output voltage accuracy may have a wider tolerance than specified.

Output Filter And Loop Stability

The TLV62130 is internally compensated to be stable with L-C filter combinations corresponding to a corner frequency to be calculated with Equation 12:

$$f_{LC} = \frac{1}{2\pi \sqrt{L \cdot C}} \quad (12)$$

Proven nominal values for inductance and ceramic capacitance are given in Table 1 and are recommended for use. Different values may work, but care has to be taken on the loop stability which will be affected. More information including a detailed LC stability matrix can be found in SLVA463.

The TLV62130 device includes an internal 25pF feedforward capacitor, connected between the VOS and FB pins. This capacitor impacts the frequency behavior and sets a pole and zero in the control loop with the resistors of the feedback divider, per equation Equation 13 and Equation 14:

$$f_{zero} = \frac{1}{2\pi \cdot R_1 \cdot 25pF} \quad (13)$$

$$f_{pole} = \frac{1}{2\pi \cdot 25pF} \cdot \left(\frac{1}{R_1} + \frac{1}{R_2} \right) \quad (14)$$

Though the TLV62130 is stable without the pole and zero being in a particular location, adjusting their location to the specific needs of the application can provide better performance in Power Save mode and/or improved transient response. An external feedforward capacitor can also be added. A more detailed discussion on the optimization for stability vs. transient response can be found in [SLVA289](#) and [SLVA466](#).

Layout Considerations

A proper layout is critical for the operation of a switched mode power supply, even more at high switching frequencies. Therefore the PCB layout of the TLV62130 demands careful attention to ensure operation and to get the performance specified. A poor layout can lead to issues like poor regulation (both line and load), stability and accuracy weaknesses, increased EMI radiation and noise sensitivity.

See [Figure 40](#) for the recommended layout of the TLV62130, which is designed for common external ground connections. Therefore both AGND and PGND pins are directly connected to the Exposed Thermal Pad. On the PCB, the direct common ground connection of AGND and PGND to the Exposed Thermal Pad and the system ground (ground plane) is mandatory. Also connect the VOS pin in the shortest way to VOUT at the output capacitor.

Provide low inductive and resistive paths for loops with high di/dt . Therefore paths conducting the switched load current should be as short and wide as possible. Provide low capacitive paths (with respect to all other nodes) for wires with high dv/dt . Therefore the input and output capacitance should be placed as close as possible to the IC pins and parallel wiring over long distances as well as narrow traces should be avoided. Loops which conduct an alternating current should outline an area as small as possible, as this area is proportional to the energy radiated.

Sensitive nodes like FB and VOS need to be connected with short wires and not nearby high dv/dt signals (e.g. SW). As they carry information about the output voltage, they should be connected as close as possible to the actual output voltage (at the output capacitor). The capacitor on the SS/TR pin and on AVIN as well as the FB resistors, R1 and R2, should be kept close to the IC and connect directly to those pins and the system ground plane.

The Exposed Thermal Pad must be soldered to the circuit board for mechanical reliability and to achieve appropriate power dissipation.

The recommended layout is implemented on the EVM and shown in its Users Guide, [SLAU416](#). Additionally, the EVM Gerber data are available for download here, [SLVC394](#).

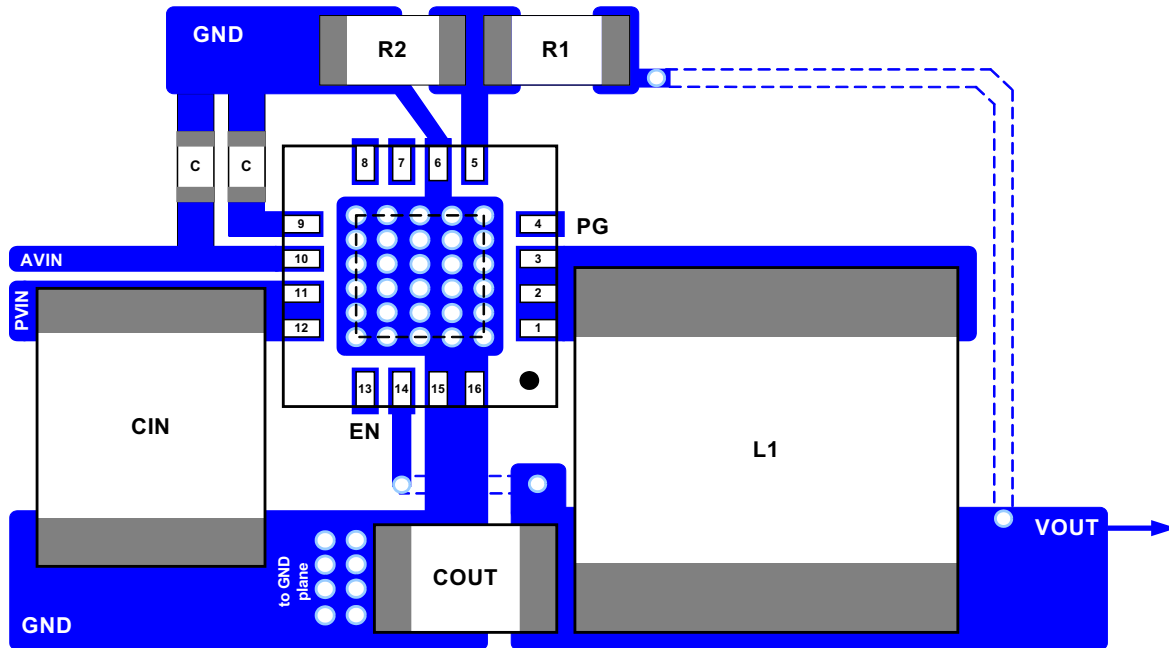

Figure 40. Layout Example

THERMAL INFORMATION

Implementation of integrated circuits in low-profile and fine-pitch surface-mount packages typically requires special attention to power dissipation. Many system-dependent issues such as thermal coupling, airflow, added heat sinks and convection surfaces, and the presence of other heat-generating components affect the power-dissipation limits of a given component.

Three basic approaches for enhancing thermal performance are listed below:

- Improving the power dissipation capability of the PCB design
- Improving the thermal coupling of the component to the PCB by soldering the Exposed Thermal Pad
- Introducing airflow in the system

For more details on how to use the thermal parameters, see the application notes: Thermal Characteristics Application Note ([SZZA017](#)), and ([SPRA953](#)).

The TLV62130 is designed for a maximum operating junction temperature (T_j) of 125°C. Therefore the maximum output power is limited by the power losses that can be dissipated over the actual thermal resistance, given by the package and the surrounding PCB structures. If the thermal resistance of the package is given, the size of the surrounding copper area and a proper thermal connection of the IC can reduce the thermal resistance. To get an improved thermal behavior, it's recommended to use top layer metal to connect the device with wide and thick metal lines. Internal ground layers can connect to vias directly under the IC for improved thermal performance.

If short circuit or overload conditions are present, the device is protected by limiting internal power dissipation. Experimental data, taken from the TLV62130 EVM, shows the maximum ambient temperature (without additional cooling like airflow or heat sink), that can be allowed to limit the junction temperature to at most 125°C (see [Figure 36](#)).

Application Example As Power LED Supply

The TLV62130 can be used as a power supply for power LEDs. The FB pin can be easily set down to lower values than nominal by using the SS/TR pin. With that, the voltage drop on the sense resistor is low to avoid excessive power loss. Since this pin provides 2.5µA, the feedback pin voltage can be adjusted by an external resistor per Equation 15. This drop, proportional to the LED current, is used to regulate the output voltage (anode voltage) to a proper level to drive the LED. Both analog and PWM dimming are supported with the TLV62130.

Figure 41 shows an application circuit, tested with analog dimming:

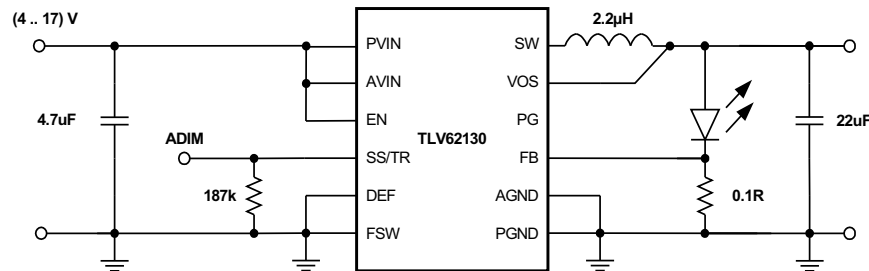

Figure 41. 3A Single LED Power Supply

The resistor at SS/TR sets the FB voltage to a level of about 300mV and is calculated from Equation 15.

$$V_{FB} = 0.64 \cdot 2.5\mu A \cdot R_{SS/TR} \quad (15)$$

The device now supplies a constant current, set by the resistor at the FB pin, by regulating the output voltage accordingly. The minimum input voltage has to be rated according to the forward voltage needed by the LED used. More information is available in the Application Note SLVA451.

Application Example As Inverting Power Supply

The TLV62130 can be used as inverting power supply by rearranging external circuitry as shown in Figure 42. As the former GND node now represents a voltage level below system ground, the voltage difference between VIN and VOUT has to be limited for operation to the maximum supply voltage of 17V (see Equation 16).

$$V_{IN} + V_{OUT} \leq V_{IN\max} \quad (16)$$

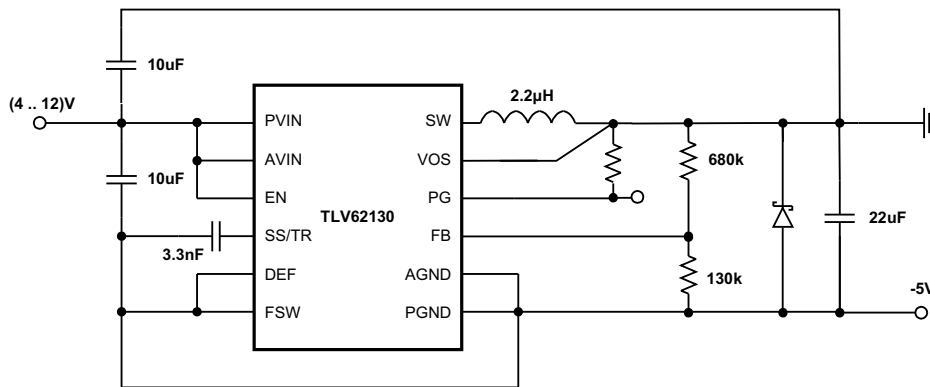

Figure 42. -5V Inverting Power Supply

The transfer function of the inverting power supply configuration differs from the buck mode transfer function, incorporating a Right Half Plane Zero additionally. The loop stability has to be adapted and an output capacitance of at least 22µF is recommended. A detailed design example is given in [SLVA469](#).

Typical Applications

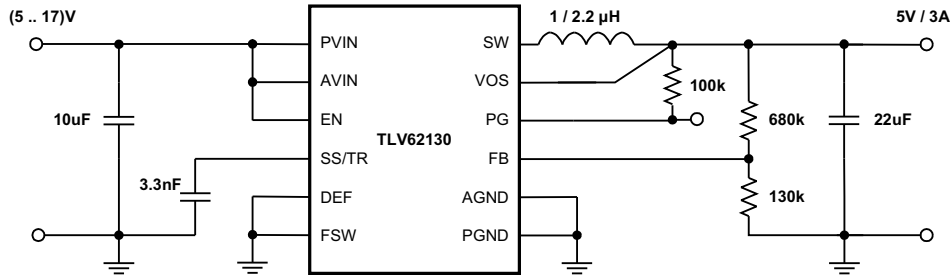

Figure 43. 5V/3A Power Supply

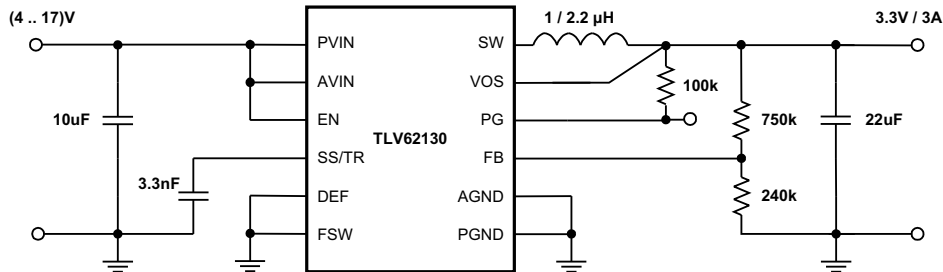

Figure 44. 3.3V/3A Power Supply

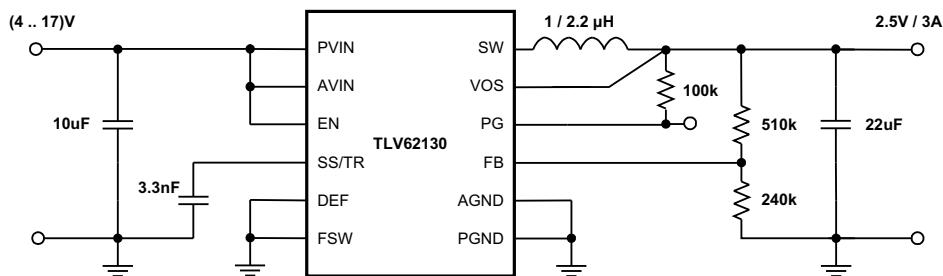

Figure 45. 2.5V/3A Power Supply

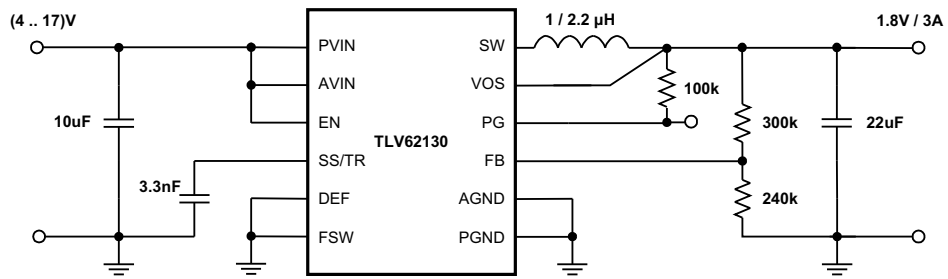

Figure 46. 1.8V/3A Power Supply

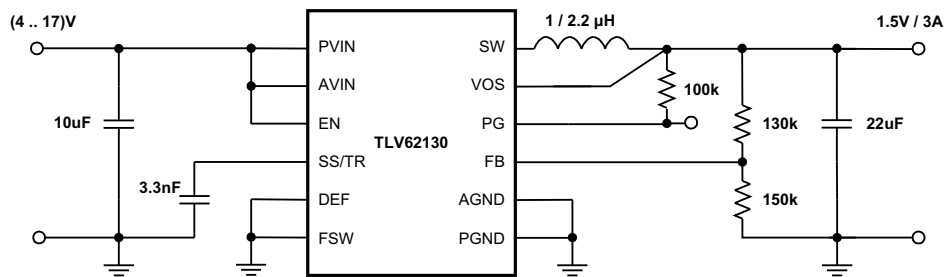

Figure 47. 1.5V/3A Power Supply

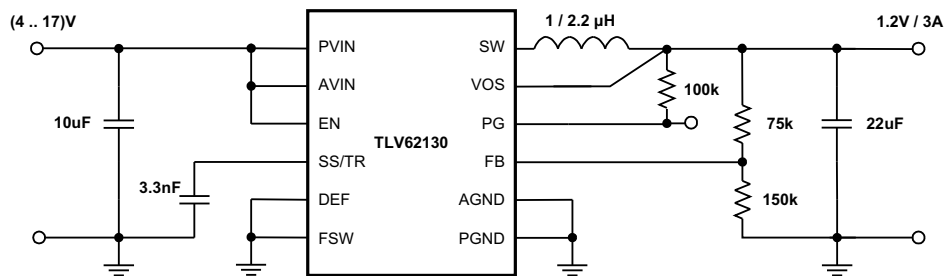

Figure 48. 1.2V/3A Power Supply

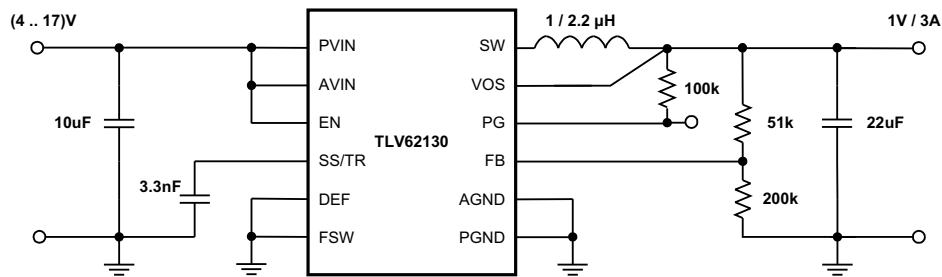

Figure 49. 1V/3A Power Supply

Active Output Discharge

The TLV62130A pulls the PG pin Low, when the device is shut down by EN, UVLO or thermal shutdown. Connecting PG to Vout through a resistor can be used to discharge Vout in those cases (see Figure 50). The discharge rate can be adjusted by R3, which is also used to pull up the PG pin in normal operation. For reliability, keep the maximum current into the PG pin less than 10mA.

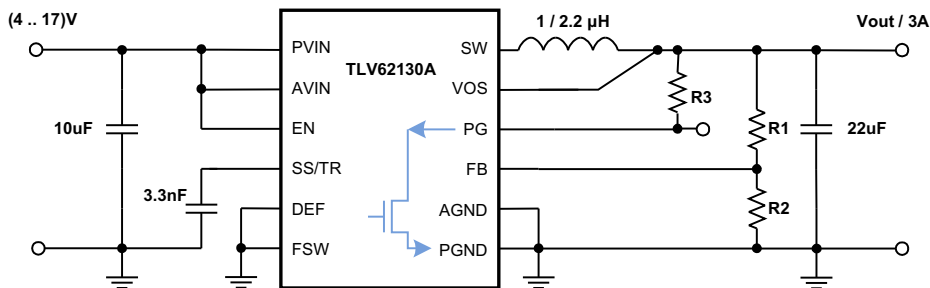

Figure 50. Discharge Vout through PG pin

REVISION HISTORY

| Changes from Original (February 2012) to Revision A | Page |
|---|-------------|
| • Changed text in Tablenote 3 of Terminal Functions table | 4 |
| • Added text to Power Save Mode Operation section for clarification. | 14 |
| • Changed Layout Considerations description for clarification. | 21 |

| Changes from Revision A (February 2013) to Revision B | Page |
|---|-------------|
| • Added device TLV62130A to data sheet | 1 |
| • Added device version TLV62130A to Ordering Info table | 2 |
| • Added text to Power Good (PG) section regarding TLV62130A function | 16 |
| • Added additional option to Pin-Selectable Output Voltage (DEF) section footnote. | 16 |
| • Added text to Frequency Selection (FSW) section regarding pin control. | 16 |
| • Added application example with regard to new version TLV62130A | 26 |

PACKAGING INFORMATION

| Orderable Device | Status (1) | Package Type | Package Drawing | Pins | Package Qty | Eco Plan (2) | Lead/Ball Finish | MSL Peak Temp (3) | Op Temp (°C) | Device Marking (4/5) | Samples |
|------------------|---------------|--------------|-----------------|------|-------------|-------------------------|------------------|----------------------|--------------|-------------------------|-------------------------|
| TLV62130ARGTR | ACTIVE | QFN | RGT | 16 | 3000 | Green (RoHS & no Sb/Br) | CU NIPDAU | Level-2-260C-1 YEAR | -40 to 85 | VUNI | Samples |
| TLV62130ARGTT | ACTIVE | QFN | RGT | 16 | 250 | Green (RoHS & no Sb/Br) | CU NIPDAU | Level-2-260C-1 YEAR | -40 to 85 | VUNI | Samples |
| TLV62130RGTR | ACTIVE | QFN | RGT | 16 | 3000 | Green (RoHS & no Sb/Br) | CU NIPDAU | Level-2-260C-1 YEAR | -40 to 85 | VUBI | Samples |
| TLV62130RGTT | ACTIVE | QFN | RGT | 16 | 250 | Green (RoHS & no Sb/Br) | CU NIPDAU | Level-2-260C-1 YEAR | -40 to 85 | VUBI | Samples |

(1) The marketing status values are defined as follows:

ACTIVE: Product device recommended for new designs.

LIFEBUY: TI has announced that the device will be discontinued, and a lifetime-buy period is in effect.

NRND: Not recommended for new designs. Device is in production to support existing customers, but TI does not recommend using this part in a new design.

PREVIEW: Device has been announced but is not in production. Samples may or may not be available.

OBSELETE: TI has discontinued the production of the device.

(2) Eco Plan - The planned eco-friendly classification: Pb-Free (RoHS), Pb-Free (RoHS Exempt), or Green (RoHS & no Sb/Br) - please check <http://www.ti.com/productcontent> for the latest availability information and additional product content details.

TBD: The Pb-Free/Green conversion plan has not been defined.

Pb-Free (RoHS): TI's terms "Lead-Free" or "Pb-Free" mean semiconductor products that are compatible with the current RoHS requirements for all 6 substances, including the requirement that lead not exceed 0.1% by weight in homogeneous materials. Where designed to be soldered at high temperatures, TI Pb-Free products are suitable for use in specified lead-free processes.

Pb-Free (RoHS Exempt): This component has a RoHS exemption for either 1) lead-based flip-chip solder bumps used between the die and package, or 2) lead-based die adhesive used between the die and leadframe. The component is otherwise considered Pb-Free (RoHS compatible) as defined above.

Green (RoHS & no Sb/Br): TI defines "Green" to mean Pb-Free (RoHS compatible), and free of Bromine (Br) and Antimony (Sb) based flame retardants (Br or Sb do not exceed 0.1% by weight in homogeneous material)

(3) MSL, Peak Temp. -- The Moisture Sensitivity Level rating according to the JEDEC industry standard classifications, and peak solder temperature.

(4) There may be additional marking, which relates to the logo, the lot trace code information, or the environmental category on the device.

(5) Multiple Device Markings will be inside parentheses. Only one Device Marking contained in parentheses and separated by a "~" will appear on a device. If a line is indented then it is a continuation of the previous line and the two combined represent the entire Device Marking for that device.

Important Information and Disclaimer: The information provided on this page represents TI's knowledge and belief as of the date that it is provided. TI bases its knowledge and belief on information provided by third parties, and makes no representation or warranty as to the accuracy of such information. Efforts are underway to better integrate information from third parties. TI has taken and

continues to take reasonable steps to provide representative and accurate information but may not have conducted destructive testing or chemical analysis on incoming materials and chemicals. TI and TI suppliers consider certain information to be proprietary, and thus CAS numbers and other limited information may not be available for release.

In no event shall TI's liability arising out of such information exceed the total purchase price of the TI part(s) at issue in this document sold by TI to Customer on an annual basis.

TAPE AND REEL INFORMATION

QUADRANT ASSIGNMENTS FOR PIN 1 ORIENTATION IN TAPE

*All dimensions are nominal

| Device | Package Type | Package Drawing | Pins | SPQ | Reel Diameter (mm) | Reel Width W1 (mm) | A0 (mm) | B0 (mm) | K0 (mm) | P1 (mm) | W (mm) | Pin1 Quadrant |
|---------------|--------------|-----------------|------|------|--------------------|--------------------|---------|---------|---------|---------|--------|---------------|
| TLV62130ARGTR | QFN | RGT | 16 | 3000 | 330.0 | 12.4 | 3.3 | 3.3 | 1.1 | 8.0 | 12.0 | Q2 |
| TLV62130ARGTT | QFN | RGT | 16 | 250 | 180.0 | 12.4 | 3.3 | 3.3 | 1.1 | 8.0 | 12.0 | Q2 |
| TLV62130RGTR | QFN | RGT | 16 | 3000 | 330.0 | 12.4 | 3.3 | 3.3 | 1.1 | 8.0 | 12.0 | Q2 |
| TLV62130RGTT | QFN | RGT | 16 | 250 | 180.0 | 12.4 | 3.3 | 3.3 | 1.1 | 8.0 | 12.0 | Q2 |

TAPE AND REEL BOX DIMENSIONS

*All dimensions are nominal

| Device | Package Type | Package Drawing | Pins | SPQ | Length (mm) | Width (mm) | Height (mm) |
|---------------|--------------|-----------------|------|------|-------------|------------|-------------|
| TLV62130ARGTR | QFN | RGT | 16 | 3000 | 552.0 | 367.0 | 36.0 |
| TLV62130ARGTT | QFN | RGT | 16 | 250 | 552.0 | 185.0 | 36.0 |
| TLV62130RGTR | QFN | RGT | 16 | 3000 | 552.0 | 367.0 | 36.0 |
| TLV62130RGTT | QFN | RGT | 16 | 250 | 552.0 | 185.0 | 36.0 |

RGT (S-PVQFN-N16)

PLASTIC QUAD FLATPACK NO-LEAD



4203495/H 10/11

- NOTES:
- All linear dimensions are in millimeters. Dimensioning and tolerancing per ASME Y14.5M-1994.
 - This drawing is subject to change without notice.
 - Quad Flatpack, No-leads (QFN) package configuration.
 - The package thermal pad must be soldered to the board for thermal and mechanical performance.
 - See the additional figure in the Product Data Sheet for details regarding the exposed thermal pad features and dimensions.
 - Falls within JEDEC MO-220.

THERMAL PAD MECHANICAL DATA

RGT (S-PVQFN-N16)

PLASTIC QUAD FLATPACK NO-LEAD

THERMAL INFORMATION

This package incorporates an exposed thermal pad that is designed to be attached directly to an external heatsink. The thermal pad must be soldered directly to the printed circuit board (PCB). After soldering, the PCB can be used as a heatsink. In addition, through the use of thermal vias, the thermal pad can be attached directly to the appropriate copper plane shown in the electrical schematic for the device, or alternatively, can be attached to a special heatsink structure designed into the PCB. This design optimizes the heat transfer from the integrated circuit (IC).

For information on the Quad Flatpack No-Lead (QFN) package and its advantages, refer to Application Report, QFN/SON PCB Attachment, Texas Instruments Literature No. SLUA271. This document is available at www.ti.com.

The exposed thermal pad dimensions for this package are shown in the following illustration.

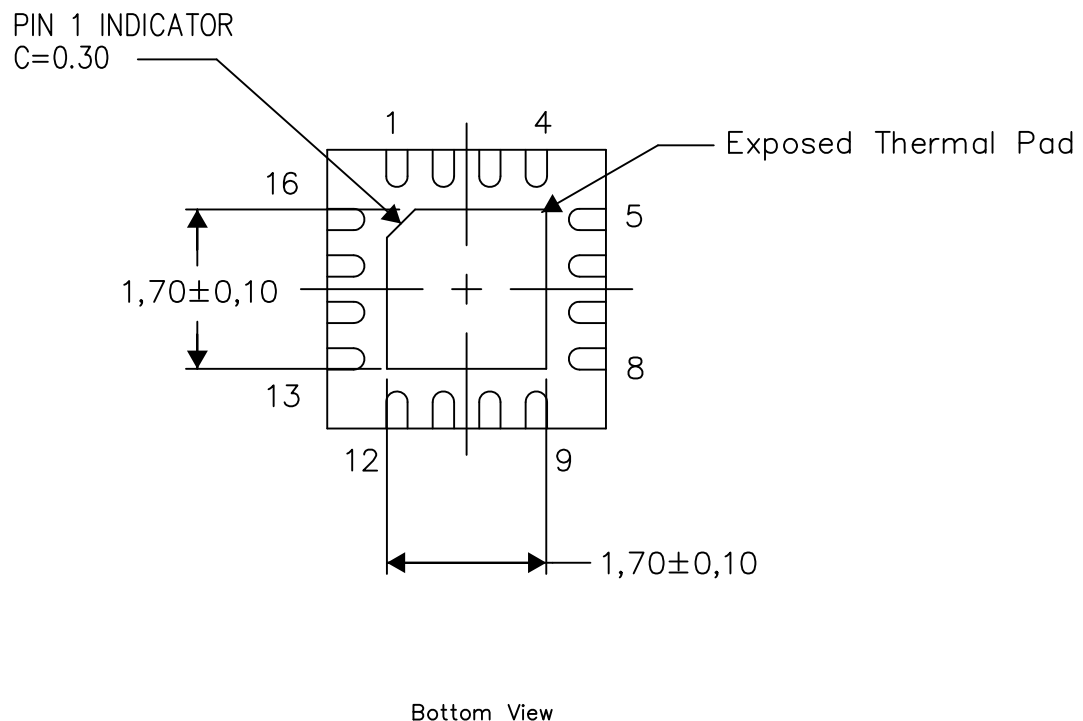

Exposed Thermal Pad Dimensions

4206349-4/U 09/13

NOTE: All linear dimensions are in millimeters

RGT (S-PVQFN-N16)

PLASTIC QUAD FLATPACK NO-LEAD

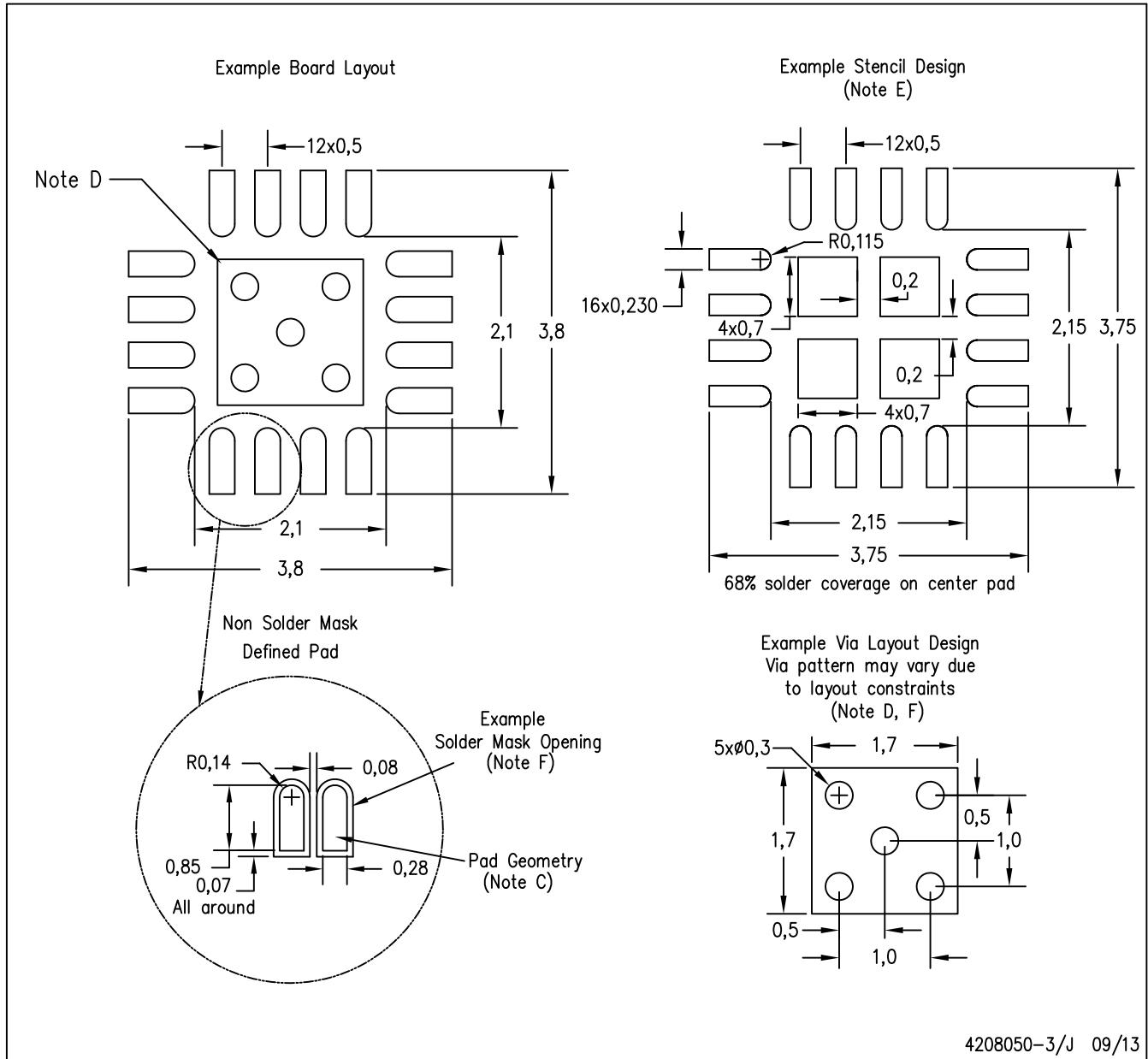

- NOTES:
- A. All linear dimensions are in millimeters.
 - B. This drawing is subject to change without notice.
 - C. Publication IPC-7351 is recommended for alternate designs.
 - D. This package is designed to be soldered to a thermal pad on the board. Refer to Application Note, QFN/SON PCB Attachment, Texas Instruments Literature No. SLUA271, and also the Product Data Sheets for specific thermal information, via requirements, and recommended board layout. These documents are available at www.ti.com <<http://www.ti.com>>.
 - E. Laser cutting apertures with trapezoidal walls and also rounding corners will offer better paste release. Customers should contact their board assembly site for stencil design recommendations. Refer to IPC 7525 for stencil design considerations.
 - F. Customers should contact their board fabrication site for minimum solder mask web tolerances between signal pads.

IMPORTANT NOTICE

Texas Instruments Incorporated and its subsidiaries (TI) reserve the right to make corrections, enhancements, improvements and other changes to its semiconductor products and services per JESD46, latest issue, and to discontinue any product or service per JESD48, latest issue. Buyers should obtain the latest relevant information before placing orders and should verify that such information is current and complete. All semiconductor products (also referred to herein as "components") are sold subject to TI's terms and conditions of sale supplied at the time of order acknowledgment.

TI warrants performance of its components to the specifications applicable at the time of sale, in accordance with the warranty in TI's terms and conditions of sale of semiconductor products. Testing and other quality control techniques are used to the extent TI deems necessary to support this warranty. Except where mandated by applicable law, testing of all parameters of each component is not necessarily performed.

TI assumes no liability for applications assistance or the design of Buyers' products. Buyers are responsible for their products and applications using TI components. To minimize the risks associated with Buyers' products and applications, Buyers should provide adequate design and operating safeguards.

TI does not warrant or represent that any license, either express or implied, is granted under any patent right, copyright, mask work right, or other intellectual property right relating to any combination, machine, or process in which TI components or services are used. Information published by TI regarding third-party products or services does not constitute a license to use such products or services or a warranty or endorsement thereof. Use of such information may require a license from a third party under the patents or other intellectual property of the third party, or a license from TI under the patents or other intellectual property of TI.

Reproduction of significant portions of TI information in TI data books or data sheets is permissible only if reproduction is without alteration and is accompanied by all associated warranties, conditions, limitations, and notices. TI is not responsible or liable for such altered documentation. Information of third parties may be subject to additional restrictions.

Resale of TI components or services with statements different from or beyond the parameters stated by TI for that component or service voids all express and any implied warranties for the associated TI component or service and is an unfair and deceptive business practice. TI is not responsible or liable for any such statements.

Buyer acknowledges and agrees that it is solely responsible for compliance with all legal, regulatory and safety-related requirements concerning its products, and any use of TI components in its applications, notwithstanding any applications-related information or support that may be provided by TI. Buyer represents and agrees that it has all the necessary expertise to create and implement safeguards which anticipate dangerous consequences of failures, monitor failures and their consequences, lessen the likelihood of failures that might cause harm and take appropriate remedial actions. Buyer will fully indemnify TI and its representatives against any damages arising out of the use of any TI components in safety-critical applications.

In some cases, TI components may be promoted specifically to facilitate safety-related applications. With such components, TI's goal is to help enable customers to design and create their own end-product solutions that meet applicable functional safety standards and requirements. Nonetheless, such components are subject to these terms.

No TI components are authorized for use in FDA Class III (or similar life-critical medical equipment) unless authorized officers of the parties have executed a special agreement specifically governing such use.

Only those TI components which TI has specifically designated as military grade or "enhanced plastic" are designed and intended for use in military/aerospace applications or environments. Buyer acknowledges and agrees that any military or aerospace use of TI components which have **not** been so designated is solely at the Buyer's risk, and that Buyer is solely responsible for compliance with all legal and regulatory requirements in connection with such use.

TI has specifically designated certain components as meeting ISO/TS16949 requirements, mainly for automotive use. In any case of use of non-designated products, TI will not be responsible for any failure to meet ISO/TS16949.

Products

| | |
|------------------------------|--|
| Audio | www.ti.com/audio |
| Amplifiers | amplifier.ti.com |
| Data Converters | dataconverter.ti.com |
| DLP® Products | www.dlp.com |
| DSP | dsp.ti.com |
| Clocks and Timers | www.ti.com/clocks |
| Interface | interface.ti.com |
| Logic | logic.ti.com |
| Power Mgmt | power.ti.com |
| Microcontrollers | microcontroller.ti.com |
| RFID | www.ti-rfid.com |
| OMAP Applications Processors | www.ti.com/omap |
| Wireless Connectivity | www.ti.com/wirelessconnectivity |

Applications

| | |
|-------------------------------|--|
| Automotive and Transportation | www.ti.com/automotive |
| Communications and Telecom | www.ti.com/communications |
| Computers and Peripherals | www.ti.com/computers |
| Consumer Electronics | www.ti.com/consumer-apps |
| Energy and Lighting | www.ti.com/energy |
| Industrial | www.ti.com/industrial |
| Medical | www.ti.com/medical |
| Security | www.ti.com/security |
| Space, Avionics and Defense | www.ti.com/space-avionics-defense |
| Video and Imaging | www.ti.com/video |

TI E2E Community

e2e.ti.com