

TOSHIBA Photocoupler Photo Relay

TLP227GA, TLP227GA-2

Modem
Telecommunications
PBXs

The Toshiba TLP227GA series consist of a gallium arsenide infrared-emitting diode optically coupled to a photo-MOSFET in a 4-pin DIP or a 8-pin DIP package, and has a peak off-State voltage of 400 V.

- Normally off function
- TLP227GA : DIP4 (1 form A)
TLP227GA-2 : DIP8 (2 form A)
- Peak off-state voltage : 400 V (min)
- Trigger LED current : 3 mA (max)
- On-state current : 120 mA (max)
- On-state resistance : 35Ω (max)
- Isolation voltage : 2500 Vrms (min)

Pin Configuration (top view)

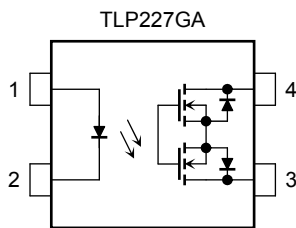

1: Anode
2: Cathode
3: Drain
4: Drain

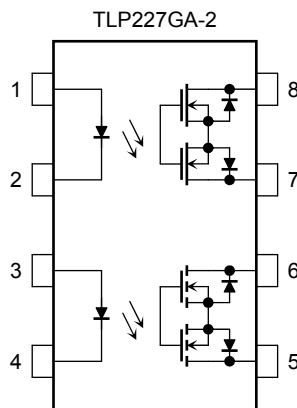

1, 3: Anode
2, 4: Cathode
5 : Drain D1
6 : Drain D2
7 : Drain D3
8 : Drain D4

Unit: mm

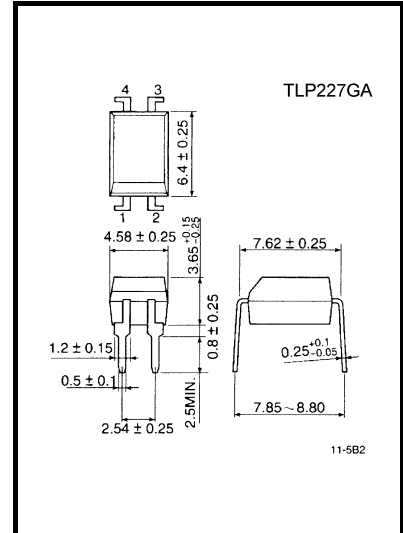

JEDEC	—
JEITA	—
TOSHIBA	11-5B2

Weight: 0.26 g (typ.)

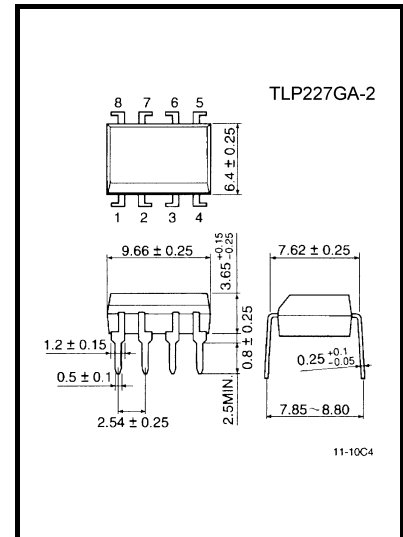

JEDEC	—
JEITA	—
TOSHIBA	11-10C4

Weight: 0.54 g (typ.)

Absolute Maximum Rating (Ta = 25°C)

Characteristic		Symbol	Rating	Unit	
Led	Forward current	I_F	50	mA	
	Forward current derating (Ta ≥ 25°C)	$\Delta I_F/^\circ\text{C}$	-0.5	mA/°C	
	Peak forward current (100 μs pulse, 100 pps)	I_{FP}	1	A	
	Reverse voltage	V_R	5	V	
	Junction temperature	T_j	125	°C	
Detector	Off-state output terminal voltage	V_{OFF}	400	V	
	On-state current	TLP227GA	I_{ON}	120	Ma
		TLP227GA-2			
	On-state current rating (Ta ≥ 25°C)	TLP227GA	$\Delta I_{ON}/^\circ\text{C}$	-1.2	mA/°C
		TLP227GA-2			
	Junction temperature		T_j	125	°C
Storage temperature range		T_{stg}	-55~125	°C	
Operating temperature range		T_{opr}	-40~85	°C	
Lead soldering temperature (10 s)		T_{sol}	260	°C	
Isolation voltage (AC, 1 min., R.H. ≤ 60%) (Note 1)		BV_S	2500	Vrms	

Note: Using continuously under heavy loads (e.g. the application of high temperature/current/voltage and the significant change in temperature, etc.) may cause this product to decrease in the reliability significantly even if the operating conditions (i.e. operating temperature/current/voltage, etc.) are within the absolute maximum ratings.

Please design the appropriate reliability upon reviewing the Toshiba Semiconductor Reliability Handbook ("Handling Precautions"/"Derating Concept and Methods") and individual reliability data (i.e. reliability test report and estimated failure rate, etc).

Note 1: LED pins are shorted together. Detector pins are also shorted together.

Recommended Operating Conditions

Characteristic	Symbol	Min	Typ.	Max	Unit
Supply voltage	V_{DD}	—	—	320	V
Forward current	I_F	5	7.5	25	mA
On-state current	I_{ON}	—	—	100	mA
Operating temperature	T_{opr}	-20	—	65	°C

Note: Recommended operating conditions are given as a design guideline to obtain expected performance of the device. Additionally, each item is an independent guideline respectively. In developing designs using this product, please confirm specified characteristics shown in this document.

Individual Electrical Characteristics (Ta = 25°C)

Characteristic		Symbol	Test Condition	Min	Typ.	Max	Unit
Led	Forward voltage	V_F	$I_F = 10 \text{ mA}$	1.0	1.15	1.3	V
	Reverse current	I_R	$V_R = 5 \text{ V}$	—	—	10	μA
	Capacitance	C_T	$V = 0, f = 1 \text{ MHz}$	—	30	—	pF
Detector	Off-state current	I_{OFF}	$V_{OFF} = 400 \text{ V}$	—	—	1	μA
	Capacitance	C_{OFF}	$V = 0, f = 1 \text{ MHz}$	—	—	—	pF

Coupled Electrical Characteristics (Ta = 25°C)

Characteristic	Symbol	Test Condition	Min	Typ.	Max	Unit
Trigger LED current	I_{FT}	$I_{ON} = 120 \text{ mA}$	—	1	3	mA
On-state resistance	R_{ON}	$I_{ON} = 120 \text{ mA}, I_F = 5 \text{ mA}$	—	18	35	Ω

Isolation Characteristics (Ta = 25°C)

Characteristic	Symbol	Test Condition	Min	Typ.	Max	Unit
Capacitance input to output	C_S	$V_S = 0 \text{ V}, f = 1 \text{ MHz}$	—	0.8	—	pF
Isolation resistance	R_S	$V_S = 500 \text{ V}, \text{R.H.} \leq 60\%$	5×10^{10}	10^{14}	—	Ω
Isolation voltage	BV_S	AC, 1 min	2500	—	—	Vrms
		AC, 1 s (in oil)	—	5000	—	—
		DC, 1 min (in oil)	—	5000	—	Vdc

Switching Characteristics (Ta = 25°C)

Characteristic	Symbol	Test Condition	Min	Typ.	Max	Unit
Turn-on time	t_{ON}	$R_L = 200 \Omega$ $V_{DD} = 20 \text{ V}, I_F = 5 \text{ mA}$ (Note 2)	—	—	1	ms
Turn-off time	t_{OFF}		—	—	1	

Note 2: Switching time test circuit

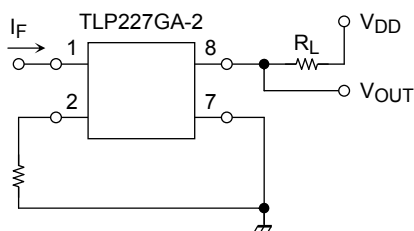
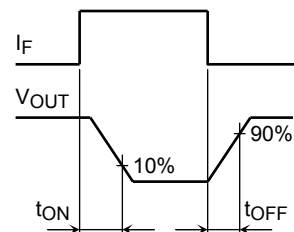
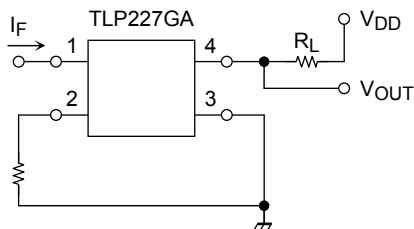

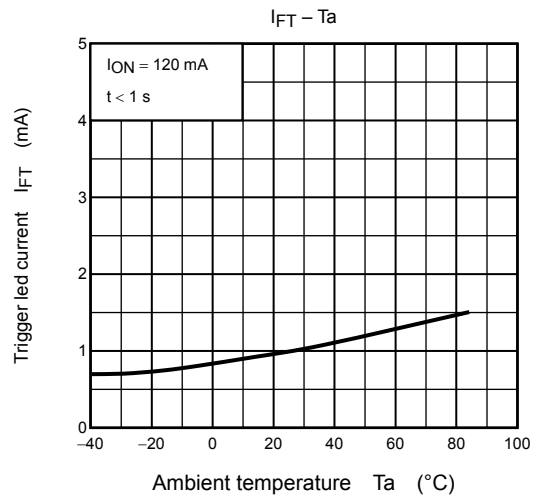
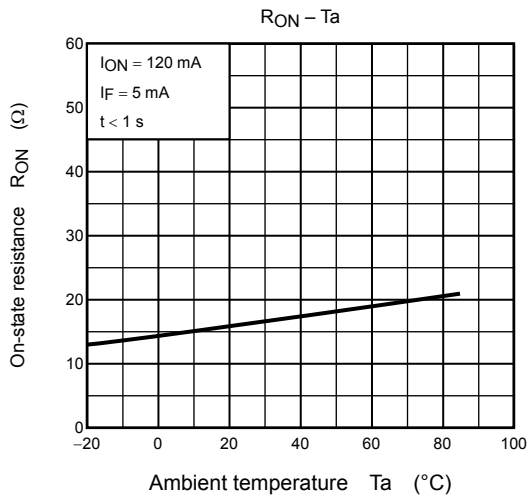
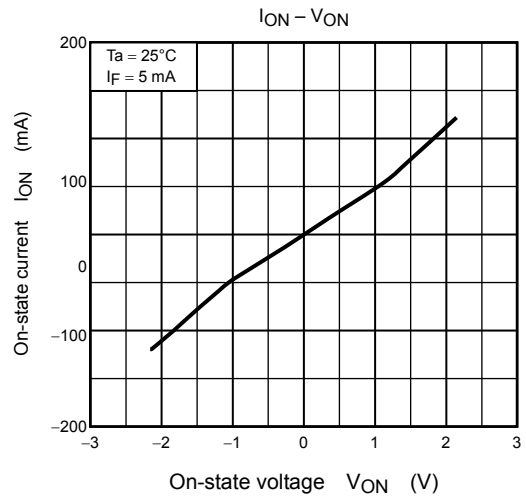
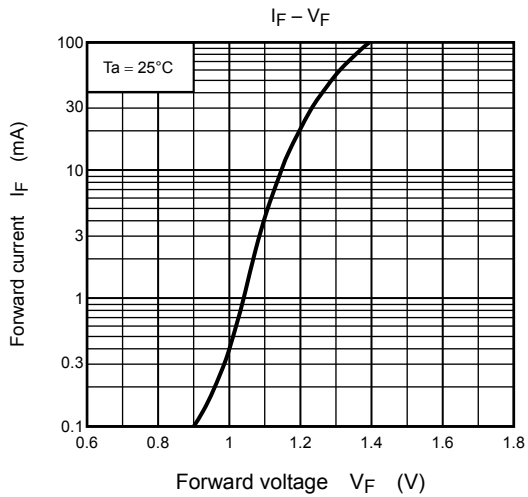
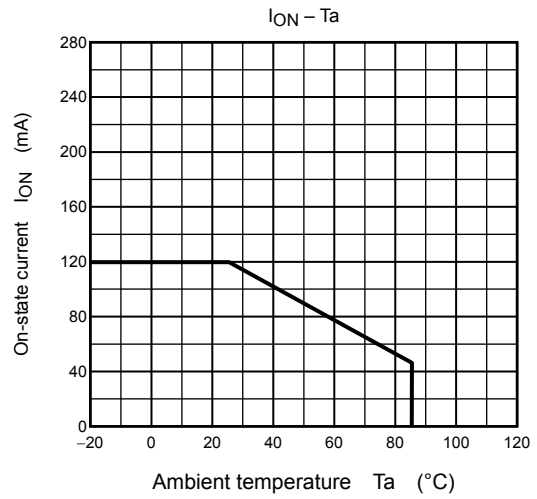
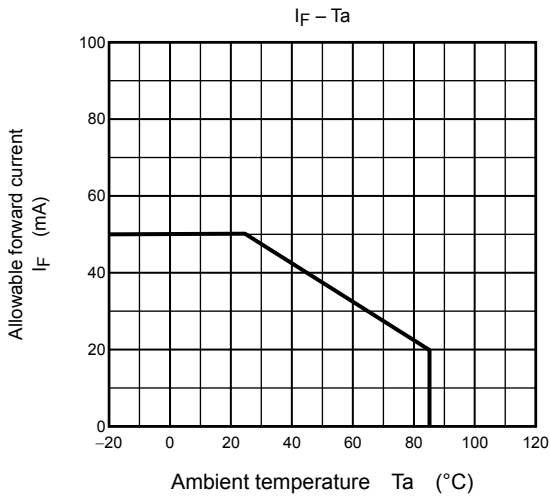

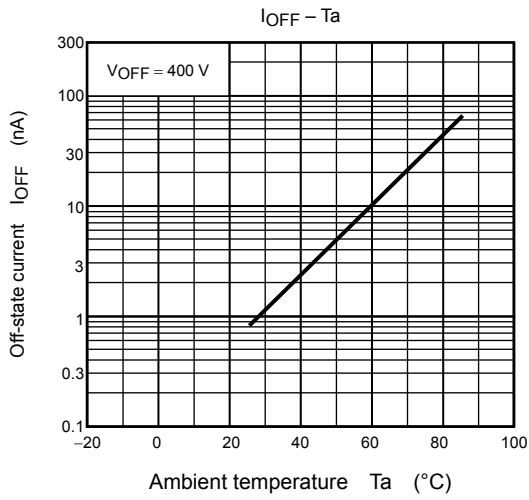
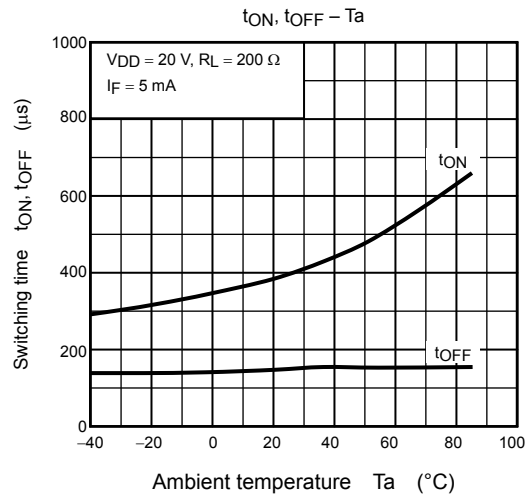
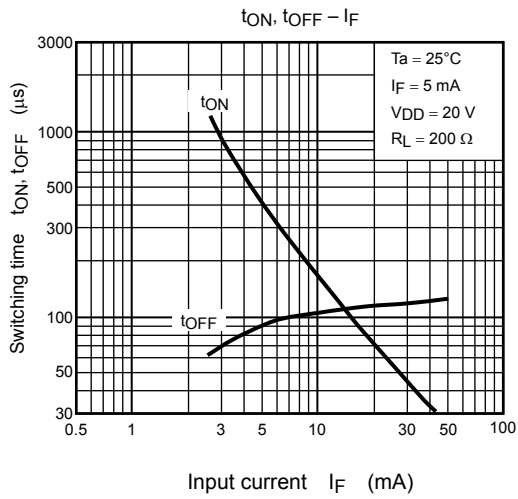

RESTRICTIONS ON PRODUCT USE

20070701-EN

- The information contained herein is subject to change without notice.
- TOSHIBA is continually working to improve the quality and reliability of its products. Nevertheless, semiconductor devices in general can malfunction or fail due to their inherent electrical sensitivity and vulnerability to physical stress. It is the responsibility of the buyer, when utilizing TOSHIBA products, to comply with the standards of safety in making a safe design for the entire system, and to avoid situations in which a malfunction or failure of such TOSHIBA products could cause loss of human life, bodily injury or damage to property.
In developing your designs, please ensure that TOSHIBA products are used within specified operating ranges as set forth in the most recent TOSHIBA products specifications. Also, please keep in mind the precautions and conditions set forth in the "Handling Guide for Semiconductor Devices," or "TOSHIBA Semiconductor Reliability Handbook" etc.
- The TOSHIBA products listed in this document are intended for usage in general electronics applications (computer, personal equipment, office equipment, measuring equipment, industrial robotics, domestic appliances, etc.). These TOSHIBA products are neither intended nor warranted for usage in equipment that requires extraordinarily high quality and/or reliability or a malfunction or failure of which may cause loss of human life or bodily injury ("Unintended Usage"). Unintended Usage include atomic energy control instruments, airplane or spaceship instruments, transportation instruments, traffic signal instruments, combustion control instruments, medical instruments, all types of safety devices, etc.. Unintended Usage of TOSHIBA products listed in this document shall be made at the customer's own risk.
- The products described in this document shall not be used or embedded to any downstream products of which manufacture, use and/or sale are prohibited under any applicable laws and regulations.
- The information contained herein is presented only as a guide for the applications of our products. No responsibility is assumed by TOSHIBA for any infringements of patents or other rights of the third parties which may result from its use. No license is granted by implication or otherwise under any patents or other rights of TOSHIBA or the third parties.
- GaAs(Gallium Arsenide) is used in this product. The dust or vapor is harmful to the human body. Do not break, cut, crush or dissolve chemically.
- Please contact your sales representative for product-by-product details in this document regarding RoHS compatibility. Please use these products in this document in compliance with all applicable laws and regulations that regulate the inclusion or use of controlled substances. Toshiba assumes no liability for damage or losses occurring as a result of noncompliance with applicable laws and regulations.