

Multi-Voltage Processor Power Supply

Data Sheet

1 Overview

1.1 Features

- High efficiency regulator system
- Wide input voltage range, up to 60V
- Stand-by mode with low current consumption
- Suitable for standard 12V, 24V and 42V PowerNets
- Step down converter as pre-regulator:
5.5V / 1.5A
- Step down slope control for lowest EME
- Switching loss minimization
- Three high current linear post-regulators with selectable output voltages:
5V / 800mA
3.3V or 2.6V / 500mA
5V or 3.3V / 350mA
- Six independent voltage trackers (followers):
5V / 17mA each
- Stand-by regulator with 1mA current capability
- Three independent undervoltage detection circuits (e.g. reset, early warning) for each linear post-regulator
- Power on reset functionality
- Window watchdog triggered by SPI
- Tracker control and diagnosis by SPI
- All outputs protected against short-circuit
- Power-DSO-36 package



Type	Ordering Code	Package
TLE 6361 G	Q 67007-A9466	P-DSO-36-12

■ SMD = Surface Mounted Device

1.2 Short functional description

The **TLE 6361 G** is a multi voltage power supply system especially designed for automotive applications using a standard 12V or 24V battery as well as the new 42V powernet. The device is intended to supply 32 bit micro-controller systems which require different supply voltage rails such as 5V, 3.3V and 2.6V. The regulators for external sensors are also provided.

The **TLE 6361 G** cascades a Buck converter block with a linear regulator and tracker block on a single chip to achieve lowest power dissipation thus being able to power the application even at very high ambient temperatures.

The step-down converter delivers a pre-regulated voltage of 5.5V with a minimum current capability of 1.5A.

Supplied by this step down converter three low drop linear post-regulators offer 5V, 3.3V, or 2.6V of output voltages depending on the configuration of the device with current capabilities of 800mA, 500mA and 350mA.

In addition the inputs of six voltage trackers are connected to the 5.5V bus voltage. Their outputs follow the main 5V linear regulator (Q_LDO1) with high accuracy and are able to drive a current of 17mA each. The trackers can be turned on and off individually by a 16 bit serial peripheral interface (SPI). Through this interface also the status information of each tracker (i.e. short circuit) can be read out.

To monitor the output voltage levels of each of the linear regulators three independent undervoltage detection circuits are available which can be used to implement the reset or an early warning function. The supervision of the μC is managed by the SPI-triggered window watchdog.

For energy saving reasons while the motor is turned off, the **TLE 6361 G** offers a stand-by mode, where the quiescent current does not exceed 30 μA typically. In this stand-by mode just the stand-by regulator remains active.

The **TLE 6361 G** is based on Infineon Power technology SPT™ which allows bipolar, CMOS and Power DMOS circuitry to be integrated on the same monolithic circuitry.

1.3 Pin configuration

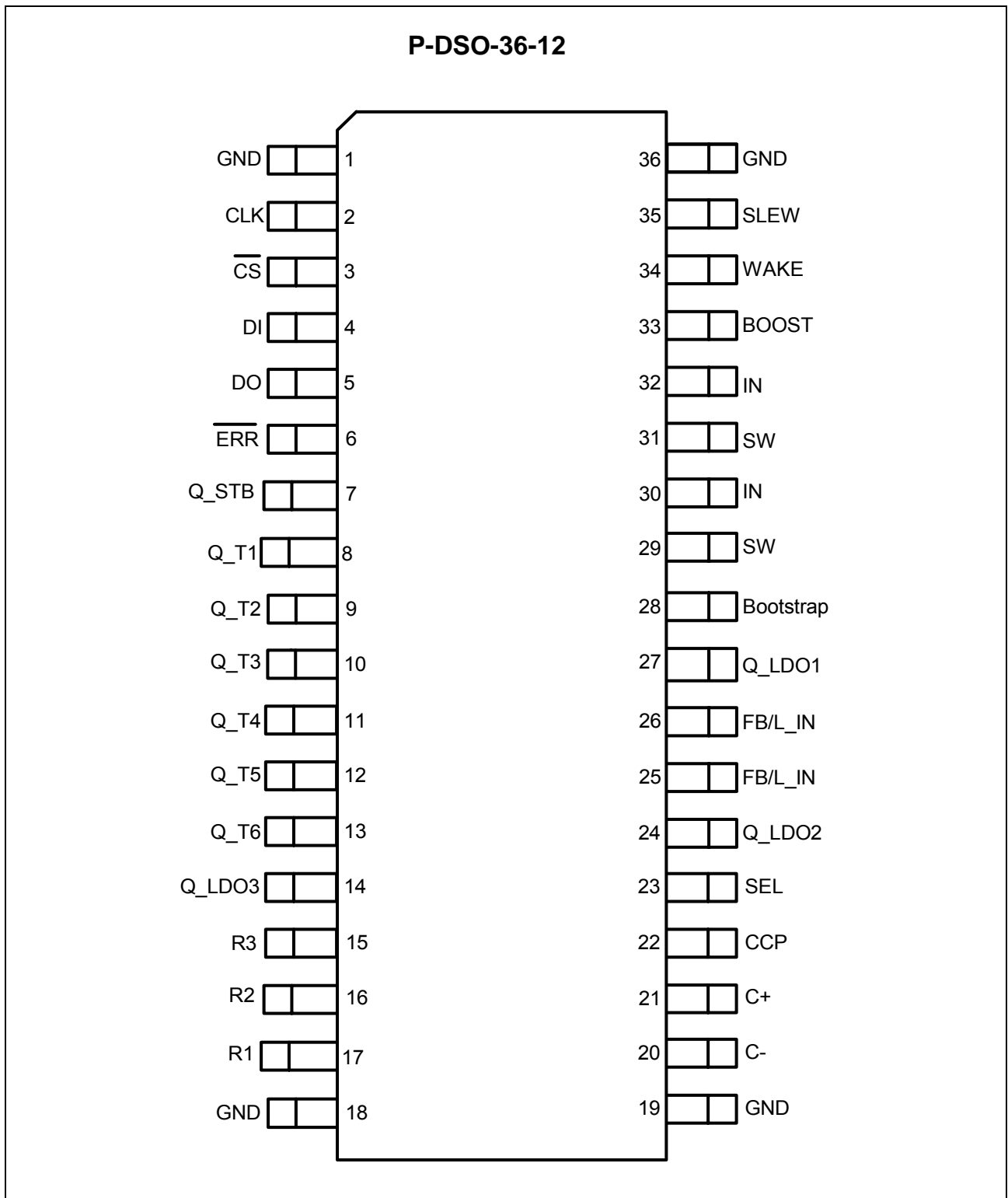

**Figure 1 Pin Configuration (Top View),
bottom heatslug and GND corner pins are connected**

1.4 Pin definitions and functions

Pin No.	Symbol	Function
1,18,19,36	GND	Ground ; to reduce thermal resistance place cooling areas on PCB close to this pins. Those pins are connected internally to the heatslug at the bottom.
2	CLK	SPI Interface Clock input ; clocks the shiftregister; CLK has an internal active pull down and requires CMOS logic level inputs;see also chapter SPI
3	$\overline{\text{CS}}$	SPI Interface chip select input ; $\overline{\text{CS}}$ is an active low input; serial communication is enabled by pulling the $\overline{\text{CS}}$ terminal low; $\overline{\text{CS}}$ input should only be switched when CLK is low; $\overline{\text{CS}}$ has an internal active pull up and requires CMOS logic level inputs ;see also chapter SPI
4	DI	SPI Interface Data input ; receives serial data from the control device; serial data transmitted to DI is a 16 bit control word with the Least Significant Bit (LSB) being transferred first; the input has an active pull down and requires CMOS logic level inputs; DI will accept data on the falling edge of CLK-signal; see also chapter SPI
5	DO	SPI Interface Data output ; this tristate output transfers diagnosis data to the controlling device; the output will remain 3-stated unless the device is selected by a low on Chip-Select $\overline{\text{CS}}$; see also the chapter SPI
6	$\overline{\text{ERR}}$	Error output ; push-pull output. Monitors failures in parallel to the SPI diagnosis word, reset via SPI. $\overline{\text{ERR}}$ is a latched output.
7	Q_STB	Standby Regulator Output ; the output is active even when the buck regulator and all other circuitry is in off mode
8	Q_T1	Voltage Tracker Output T1 tracked to Q_LDO1; bypass with a 1 μ F ceramic capacitor for stability. It is switched on and off by SPI command. Keep open, if not needed.
9	Q_T2	Voltage Tracker Output T2 tracked to Q_LDO1; bypass with a 1 μ F ceramic capacitor for stability. It is switched on and off by SPI command. Keep open, if not needed.
10	Q_T3	Voltage Tracker Output T3 tracked to Q_LDO1; bypass with a 1 μ F ceramic capacitor for stability. It is switched on and off by SPI command. Keep open, if not needed.

1.4 Pin definitions and functions (cont'd)

Pin No.	Symbol	Function
11	Q_T4	Voltage Tracker Output T4 tracked to Q_LDO1; bypass with a 1 μ F ceramic capacitor for stability. It is switched on and off by SPI command. Keep open, if not needed.
12	Q_T5	Voltage Tracker Output T5 tracked to Q_LDO1; bypass with a 1 μ F ceramic capacitor for stability. It is switched on and off by SPI command. Keep open, if not needed.
13	Q_T6	Voltage Tracker Output T6 tracked to Q_LDO1; bypass with a 1 μ F ceramic capacitor for stability. It is switched on and off by SPI command. Keep open, if not needed.
14	Q_LDO3	Voltage Regulator Output 3; 5V or 3.3V output ; output voltage is selected by pin SEL (see also 3.4.2); For stability a ceramic capacitor of 470nF to GND is sufficient.
15	R3	Reset output 3 , undervoltage detection for output Q_LDO3; open collector output; an external pullup resistor of 10k Ω is required
16	R2	Reset output 2 , undervoltage detection for output Q_LDO2; open collector output; an external pullup resistor of 10k Ω is required
17	R1	Reset output 1 , undervoltage detection for output Q_LDO1 and watchdog failure reset; open collector output ; an external pullup resistor of 10k Ω is required
20	C-	Charge pump capacitor connection ; Add the fly-capacitor of 100nF between C+ and C-
21	C+	Charge pump capacitor connection ; Add the fly-capacitor of 100nF between C+ and C-
22	CCP	Charge Pump Storage Capacitor Output ; Add the storage capacitor of 220nF between pin CCP and GND.
23	SEL	Select Pin for output voltage adjust of Q_LDO2 and Q_LDO3 (see also 2.2.2)
24	Q_LDO2	Voltage Regulator Output 2; 3.3V or 2.6V output ; output voltage is selected by pin SEL (see also 3.4.2); For stability a ceramic capacitor of 470nF to GND is sufficient.
25, 26	FB/L_IN	Feedback and Linear Regulator Input ; input connection for the Buck converter output

1.4 Pin definitions and functions (cont'd)

Pin No.	Symbol	Function
27	Q_LDO1	Voltage Regulator Output 1; 5V output ; acts as the reference for the voltage trackers. The SPI and window watchdog logic is supplied from this voltage. For stability a ceramic capacitor of 470nF to GND is sufficient.
28	Bootstrap	Bootstrap Input ; add the bootstrap capacitor between pin SW and pin Bootstrap, the capacitance value should be not lower than 2% of the Buck converter output capacitance
29, 31	SW	Switch Output ; connect both pins externally through short lines directly to the cathode of the catch diode and the Buck circuit inductance.
30, 32	IN	Supply Voltage Input ; connect both pins externally through short lines to the input filter/the input capacitors.
33	BOOST	Boost Input ; for switching loss minimization connect a diode (cathode directly to boost pin) in series with a 100nF ceramic capacitor to the IN pin and from the anode of the diode to the buck converter output a 22Ω resistor. Recommended for 42V applications, in 12/24V applications connect boost directly to IN
34	WAKE	Wake Up Input ; a positive voltage applied to this pin turns on the device
35	SLEW	Slew control Input ; a resistor to GND defines the current slope in the buck switch for reduced EME

1.5 Basic block diagram

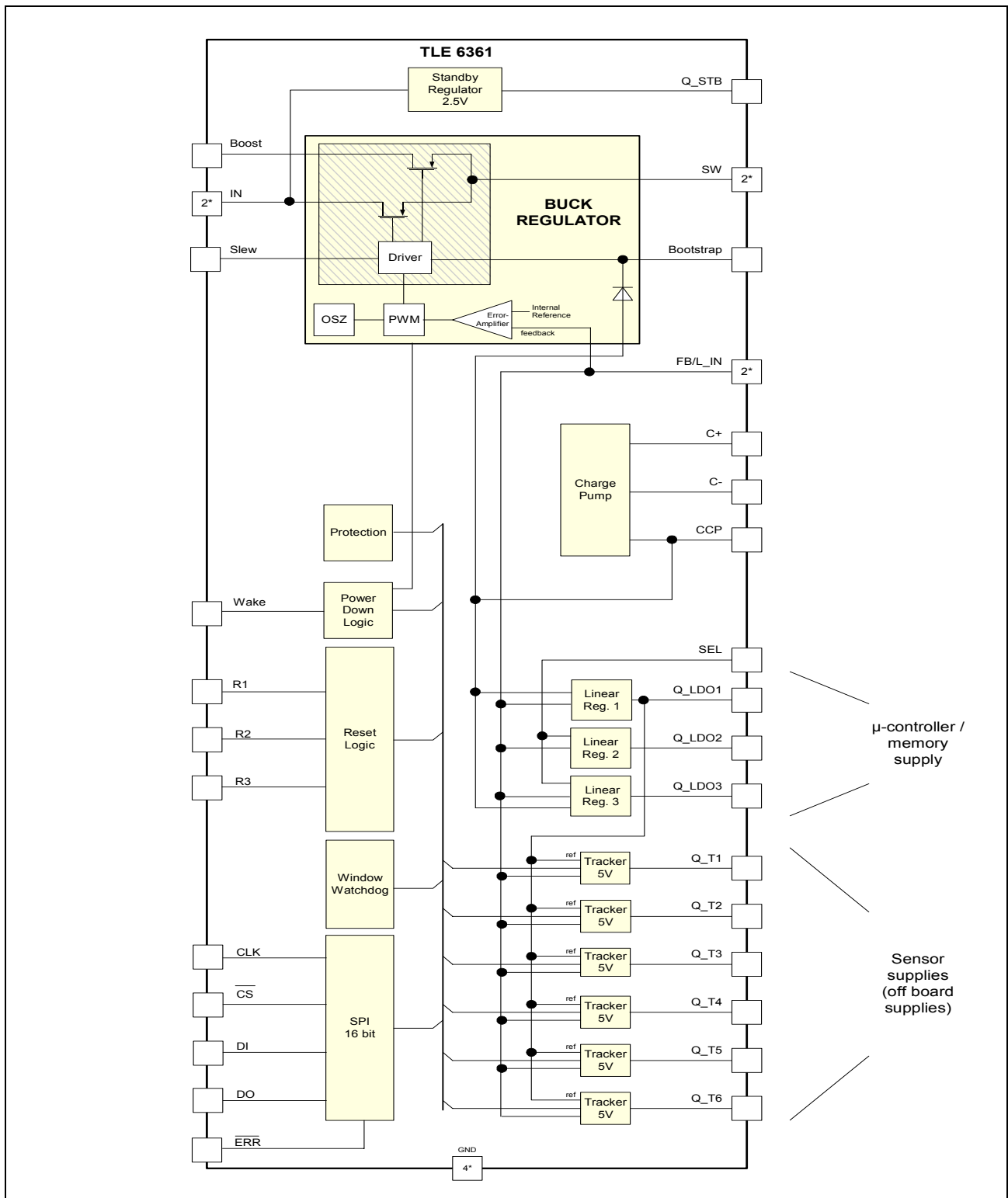

Figure 2 Block Diagram

2 Detailed circuit description

In the following major buck regulator blocks, the linear voltage regulators and trackers, the undervoltage reset function, the watchdog and the SPI are described in more detail. For applications information e.g. choice of external components, please refer to section .

2.1 Buck Regulator

The diagram below shows the internal implemented circuit of the Buck converter, i. e. the internal DMOS devices, the regulation loop and the other major blocks.

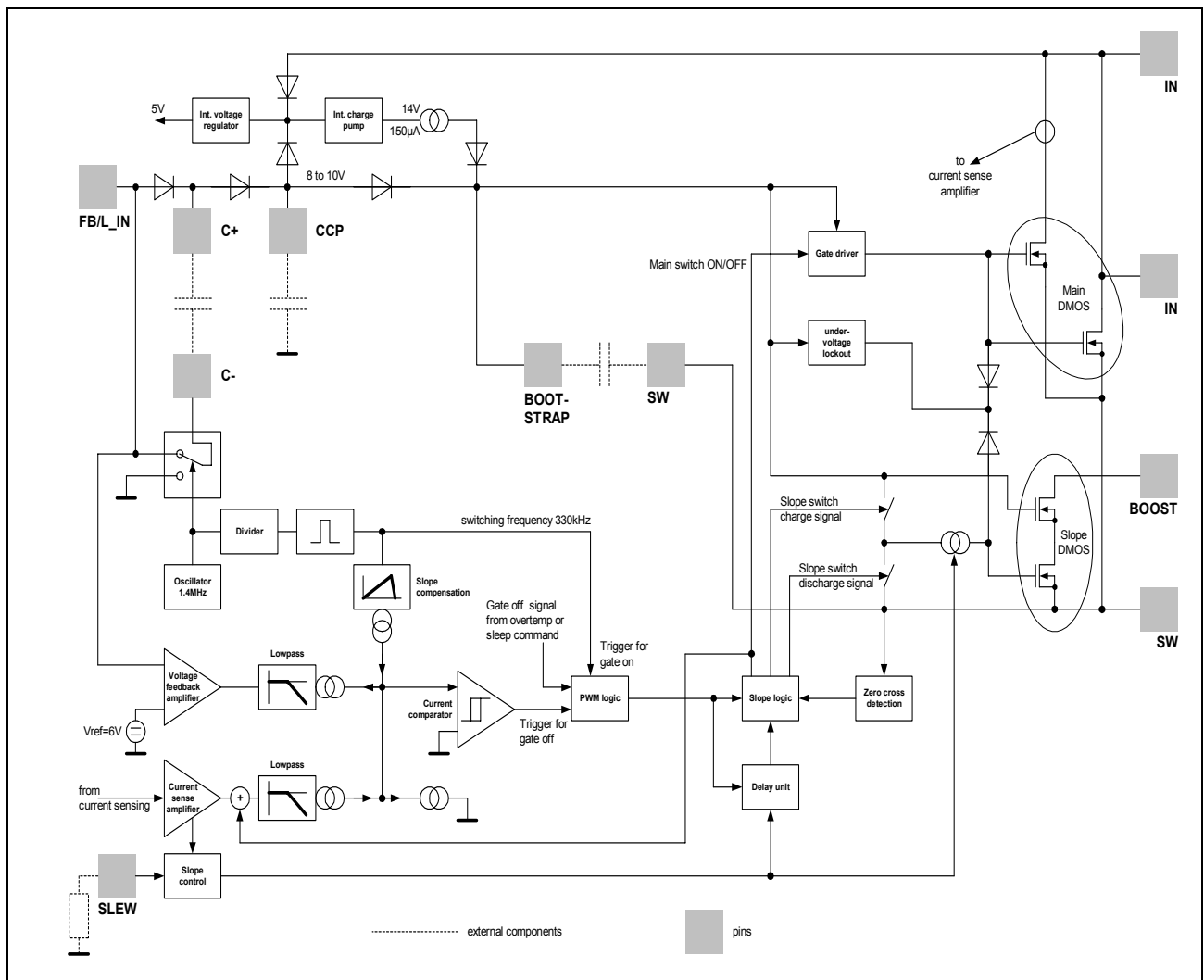

Figure 3 Detailed Buck regulator diagram

The 1.5A Buck regulator consists of two internal DMOS power stages including a current mode regulation scheme to avoid external compensation components plus additional blocks for low EME and reduced switching loss. Figure 3 indicates also the principle how

the gate driver supply is managed by the combination of internal charge pump, external charge pump and bootstrap capacitor.

2.1.1 Current mode control scheme

The regulation loop is located at the left lower corner in the schematic, there you find the voltage feedback amplifier which gives the actual information of the actual output voltage level and the current sense amplifier for the load current information to form finally the regulation signal. To avoid subharmonic oscillations at duty cycles higher than 50% the slope compensation block is necessary.

The control signal formed out of those three blocks is finally the input of the PWM regulator for the DMOS gate turn off command, which means this signal determines the duty cycle. The gate turn on signal is set by the oscillator periodically every 3 μ s which leads to a Buck converter switching frequency around 330kHz.

With decreasing input voltage the device changes to the so called pulse skipping mode which means basically that some of the oscillator gate turn off signals are ignored. When the input voltage is still reduced the DMOS is turned on statically (100% duty cycle) and its gate is supplied by the internal charge pump. Below typical 4.5V at the feedback pin the device is turned off. During normal switching operation the gate driver is supplied by the bootstrap capacitor.

2.1.2 Start-up procedure

To guarantee a device startup even under full load condition at the linear regulator outputs a special start up procedure is implemented. At first the bootstrap capacitor is charged by the internal charge pump. Afterwards the output capacitor is charged where the driver supply in that case is maintained only by the bootstrap capacitor. Once the output capacitor of the buck converter is charged the external charge pump is activated being able to supply the linear regulators and finally the linear regulators are released to supply the loads.

2.1.3 Reduction of electromagnetic emission

In figure 3 it is recognized that two internal DMOS switches are used, a main switch and an auxiliary switch. The second implemented switch is used to adjust the current slope of the switching current. The slope adjustment is done by a controlled charge and discharge of the gate of this DMOS. By choosing the external slew resistor appropriate the current transition time can be adjusted between 20ns and 100ns.

2.1.4 Reducing the switching losses

The second purpose of the slope DMOS is to minimise the switching losses. Once being in freewheeling mode of the buck regulator the output voltage level is sufficient to force the load current to flow, the input voltage level is not needed in the first moment. By a feedback network consisting of a resistor and a diode to the boost pin (connection see

section) the output voltage level is present at the drain of the switch. As soon as the voltage at the SW pin passes zero volts the handover to the main switch occurs and the traditional switching behaviour of the Buck switch can be observed.

2.2 Linear Voltage Regulators

The Linear regulators offer voltage rails of 5V, 3.3V and 2.6V which can be determined by a hardware connection (see table at 2.2.2) for proper power up procedure. Being supplied by the output of the Buck pre-regulator the power loss within the three linear regulators is minimized.

All voltage regulators are short circuit protected which means that each regulator provides a maximum current according to its current limit when shorted. Together with the external charge pump the NPN pass elements of the regulators allow low dropout voltage operation. By using this structure the linear regulators work stable even with a minimum of 470nF ceramic capacitors at their output.

Q_LDO1 has 5V nominal output voltage, Q_LDO2 has a hardware programmable output voltage of 3.3V or 2.6V and Q_LDO3 is programmable to 5V or 3.3V (see 2.2.2). All three regulators are on all the time, if one regulator is not needed a base load resistor in parallel to the output capacitance for controlled power down is recommended.

2.2.1 Startup Sequence Linear Regulators

When acting as 32 bit μ C supply the so-called power sequencing (the dependency of the different voltage rails to each other) is important. Within the TLE 6361 G the following Startup-Sequence is defined (see also figure 4):

$V_{Q_LDO2} \leq V_{Q_LDO1}$; $V_{Q_LDO3} \leq V_{Q_LDO1}$ with $V_{Q_LDO1} = 5V$, $V_{Q_LDO2} = 2.6V$ and $V_{Q_LDO3} = 3.3V$
and

$V_{Q_LDO2} \leq V_{Q_LDO1}$ with $V_{Q_LDO1} = 5V$, $V_{Q_LDO2} = 2.6V/3.3V$ and $V_{Q_LDO3} = 5V$

The power sequencing refers to the regulator itself, externally voltages applied at Q_LDO2 and Q_LDO3 are not pulled down actively by the device if Q_LDO1 is lower than those outputs.

That means for the power down sequencing if different output capacitors and different loads at the three outputs of the linear regulators are used the voltages at Q_LDO2 and Q_LDO3 might be higher than at Q_LDO1 due to slower discharging. To avoid this behaviour three Schottky diodes have to be connected between the three outputs of the linear regulators in that way that the cathodes of the diodes are always connected to the higher nominal rail.

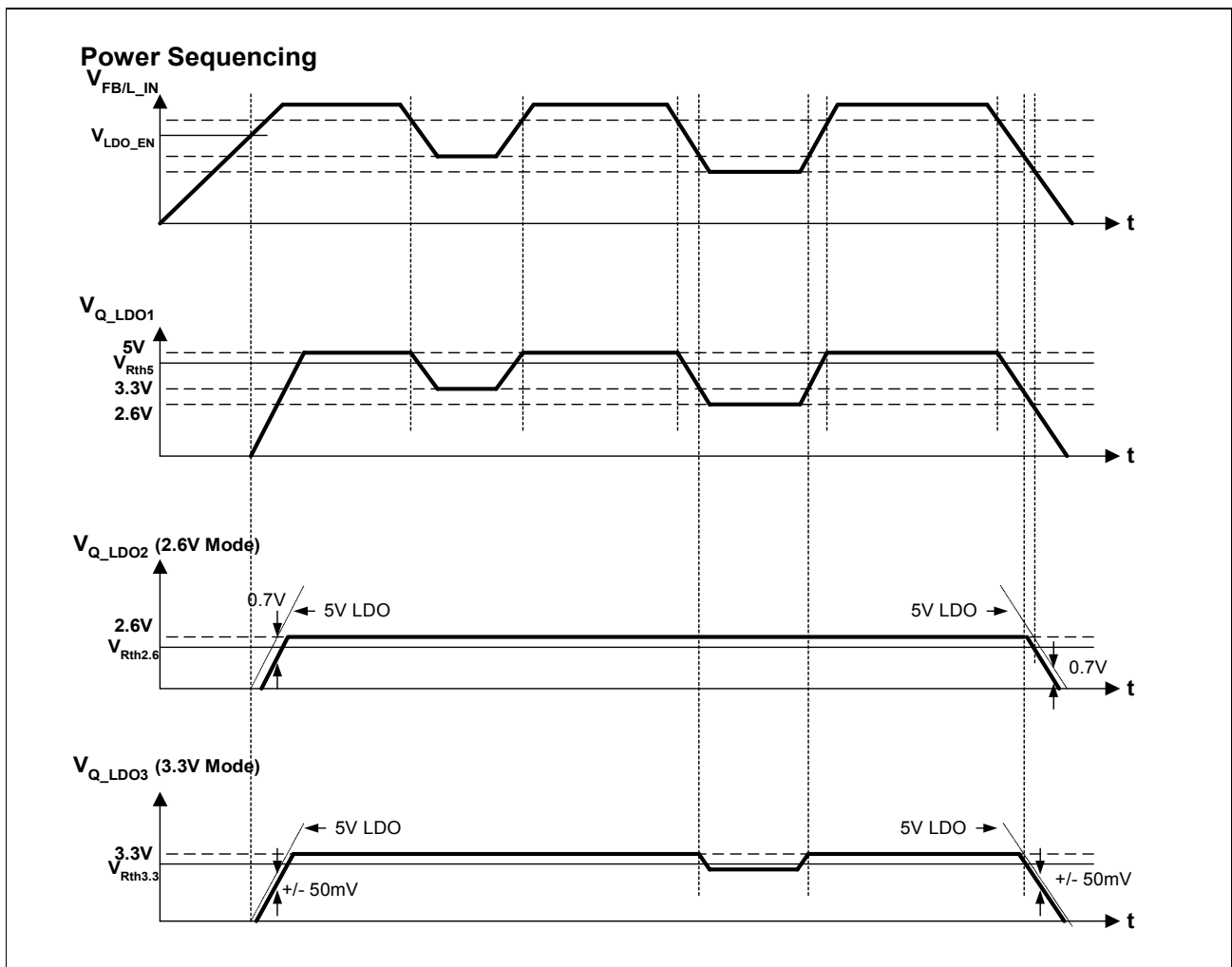

Figure 4 Power-up and -down sequencing of the regulators

2.2.2 Q_LDO2 and Q_LDO3 output voltage selection*

To determine the output voltage levels of the three linear regulators, the selection pin (SEL, pin 23) has to be connected according to the matrix given in the table below.

Definition of Output voltage Q_LDO2 and Q_LDO3

Select Pin SEL connected to	Q_LDO2 output voltage	Q_LDO3 output voltage
GND	3.3 V	5 V
Q_LDO1	2.6 V	3.3 V
Q_LDO2	2.6 V	5 V

* for different output voltages please refer to the multi voltage supply TLE6368

2.3 Voltage Trackers

For off board supplies i.e. sensors six voltage trackers Q_T1 to Q_T6 with 17mA output current capability each are available. The output voltages match Q_LDO1 within +5 / -15mV. They can be individually turned on and off by the appropriate SPI command word sent by the microcontroller. A ceramic capacitor with the value of 1 μ F at the output of each tracker is sufficient for stable operation without oscillation.

The tracker outputs can be connected in parallel to obtain a higher output current capability, no matter if only two or up to all six trackers are tied together. For uniformly distributed current density in each tracker internal balance resistors at each output are foreseen internally. By connecting twice three trackers in parallel two sensors with more than 50mA each can be supplied, all six in parallel give more than 100mA.

The tracker outputs can withstand short circuits to GND or battery in a range from -4 to +40V. A short circuit to GND is detected and indicated individually for each tracker in the SPI status word. Also an open load condition might be recognised and indicated as a failure condition in the SPI status word. A minimum load current of 2mA is required to avoid open load failure indication. In case of connecting several trackers to a common branch balancing currents can prevent proper operation of the failure indication.

2.4 Standby Regulator

The standby regulator is an ultra low power 2.5V linear voltage regulator with 1mA output current which is on all the time. It is intended to supply the microcontroller in stop mode and requires then only a minimum of quiescent current (<30 μ A) to extend the battery lifetime.

2.5 Charge Pump

The 1.6 MHz charge pump with the two external capacitors will serve to supply the base of the NPN linear regulators Q_LDO1 and Q_LDO3 as well as the gate of the Buck DMOS transistor in 100% duty cycle operation at low battery condition. The charge pump voltage in the range of 8 to 10V can be measured at pin 22 (CCP) but is not intended to be used as a supply for additional circuitry.

2.6 Power On Reset

A power on reset is available for each linear voltage regulator output. The reset output lines R1, R2 and R3 are active (low) during start up and turn inactive with a reset delay time after Q_LDO1, Q_LDO2 and Q_LDO3 have reached their reset threshold. The reset outputs are open collector, three pull up resistors of 10k Ω each have to be connected to the I/O rail (e.g. Q_LDO1) of the μ C. All three reset outputs can be linked in parallel to obtain a wired-OR.

The reset delay time is 64 ms by default and can be set to lower values as 8 ms, 16 ms or 32 ms by SPI command. At each power up of the device when the output voltage at

Q_LDO1 has decreased below 3.3V (max.) the default settings are valid, means the 64ms delay time. If the voltage on Q_LDO1 during sleep or power off mode was kept above 3.3V the delay time set by the last SPI command is valid.

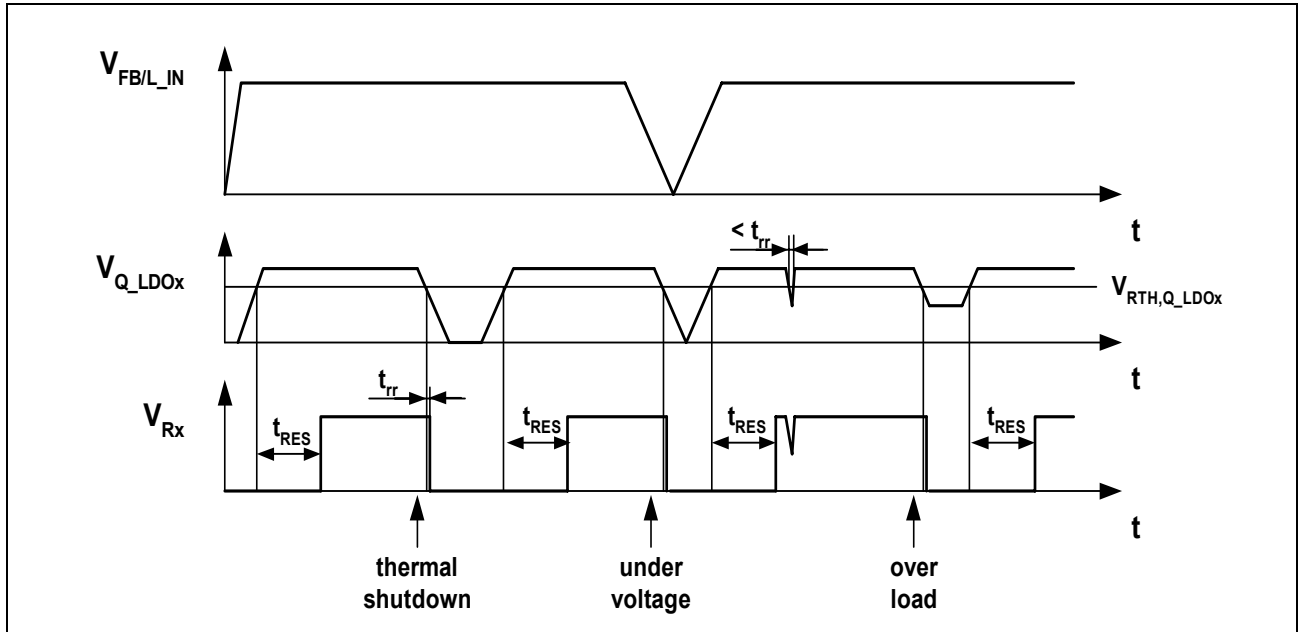

Figure 5 Undervoltage reset timing

2.7 RAM good flag

A RAM good flag will be set within the SPI status word when the Q_LDO1 voltage drops below 2.3V. A second one will be set if Q_LDO2 drops below typical 1.4V. Both RAM good flags can be read after power up to determine if a cold or warm start needs to be processed. Both RAM good flags will be reset after each SPI cycle.

2.8 \overline{ERR} Pin

An hardware error pin indicates any fault conditions on the chip. It should be connected to an interrupt input of the microcontroller. A low signal indicates an error condition. The microcontroller can read the root cause of the error by reading the SPI register.

2.9 Window Watchdog

The on board window watchdog for supervision of the μC works in combination with the SPI. The window watchdog logic is triggered when \overline{CS} is low and Bit WD-Trig in the SPI command word is set to "1". The watchdog trigger is recognized with the low to high transition of the \overline{CS} signal. To allow reading the SPI at any time without getting a reset due to misinterpretation the WD-Trig bit has to be set to "0" to avoid false trigger conditions. To disable the window watchdog the WD-OFF bits need to be set to "010".

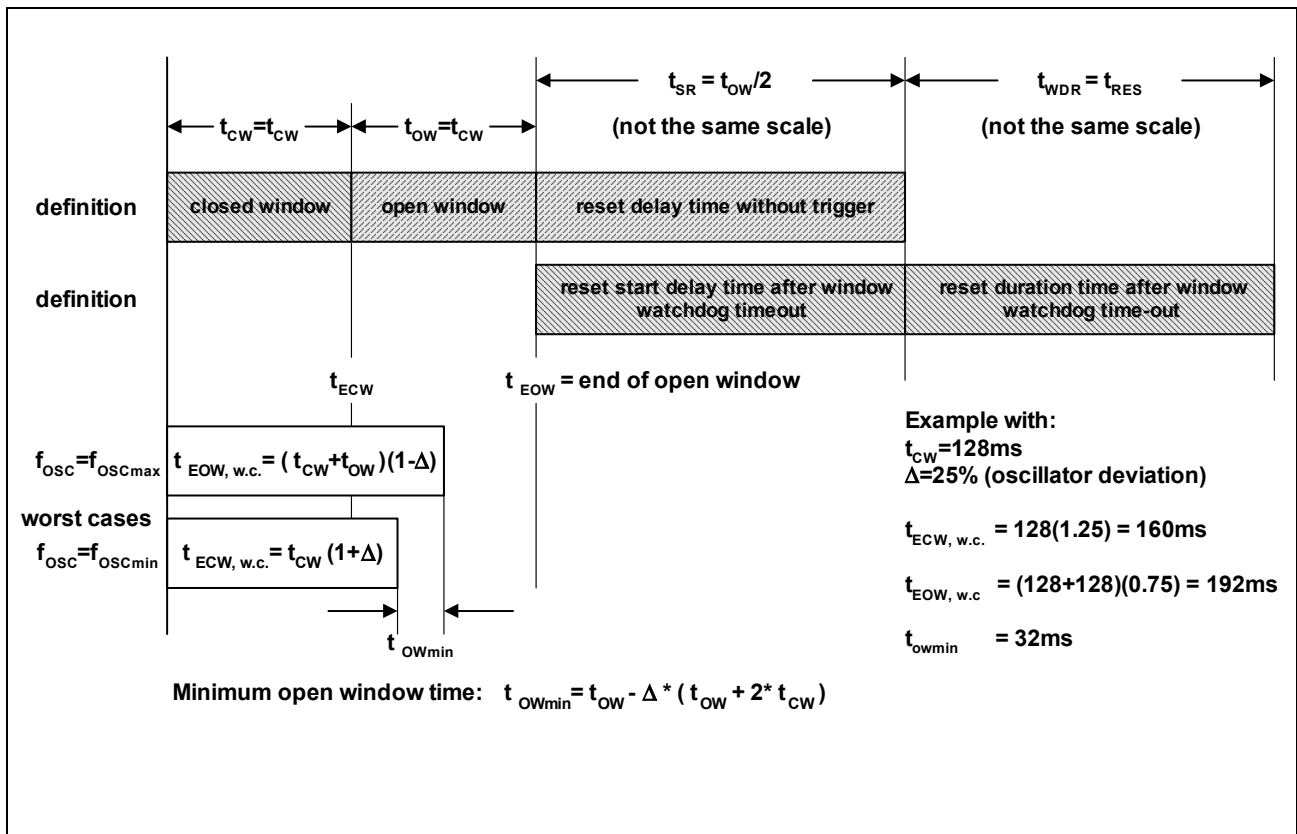

Figure 6 Window watchdog timing definition

Figure 6 shows some guidelines for designing the watchdog trigger timing taking the oscillator deviation of different devices into account. Of importance is the maximum (w.c.) of the closed window and the minimum of the open window in which the trigger has to occur.

The length of the OW and CW can be modified by SPI command. If a change of the window length is desired during the Watchdog function is operating please send the SPI command with the new timing with a 'Watchdog trigger Bit' D15=1. In this case the next CW will directly start with the new length.

A minimum time gap of $> 1/48$ of the actual OW/CW time between a 'Watchdog disable' and 'Watchdog enable' SPI-command should be maintained. This allows the internal Watchdog counters to be resetted. Thus after the enable command the Watchdog will start properly with a full CW of the adjusted length.

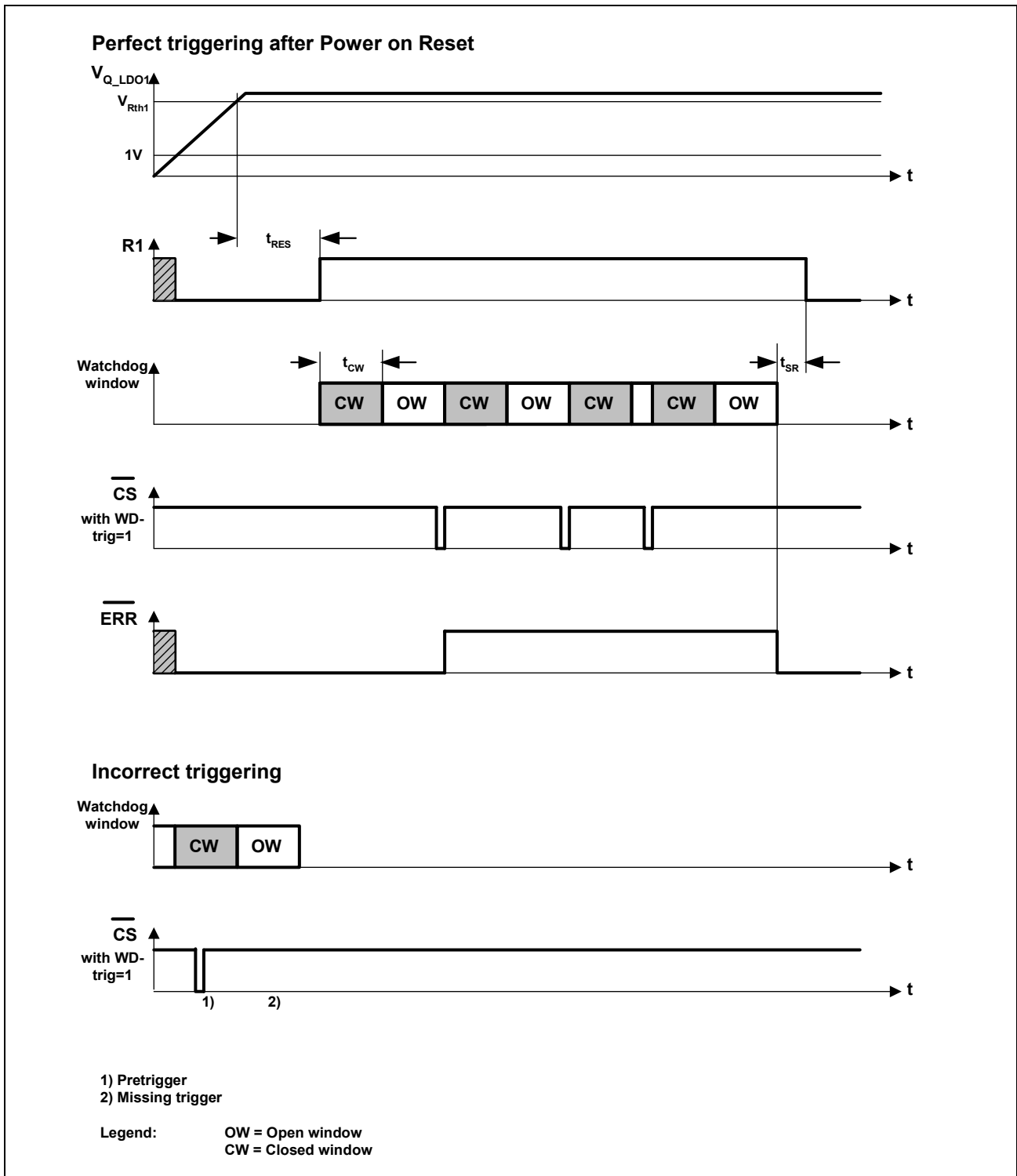

Figure 7 Window watchdog timing

Figure 7 gives some timing information about the window watchdog. Looking at the upper signals the perfect triggering of the watchdog is shown. When the 5V linear regulator Q_LDO1 reaches its reset threshold, the reset delay time has to run off before

the closed window (CW) starts. Then three valid watchdog triggers are shown, no effect on the reset line and/or error pin is observed. With the missing watchdog trigger signal the error signal turns low immediately where the reset is asserted after another delay of half the closed window time.

Also shown in the figure are two typical failure modes, one pretrigger and one missing signal. In both cases the error signal will go low immediately the failure is detected with the reset following after the half closed window time.

2.10 Overtemperature Protection

At a chip temperature of more than 130° an error and temperature flag is set and can be read through the SPI. The device is switched off if the device reaches the overtemperature threshold of 170°C. The overtemperature shutdown has a hysteresis to avoid thermal pumping.

2.11 Power Down Mode

The TLE 6361 G is started by a static high signal at the wake input or a high pulse with a minimum of 50µs duration at the Wake input (pin 34). Voltages in the range between the turn on and turn off thresholds for a few 100µs must be avoided!

By SPI command (“Sleep”-bit, D8, equals zero) all voltage regulators including the switching regulator except the standby regulator can be turned off completely only if the wake input is low. In the case the Wake input is permanently connected to battery the device cannot be turned off by SPI command, it will always turn on again.

For stable “on” operation of the device the “Sleep”-bit, D8 has to be set to high at each SPI cycle!

When powering the device again after power down the status of the SPI controlled devices (e.g. trackers, watchdog etc.) depends on the output voltage on Q_LDO1. Did the voltage at Q_LDO1 decrease below 3.3V the default status (given in the next section) is set otherwise the last SPI command defines the status.

2.12 Serial Peripheral Interface

A standard 16bit SPI is available for control and diagnostics. It is capable to operate in a daisy chain. It can be written or read by a 16 bit SPI interface as well as by an 8 bit SPI interface.

The 16-bit control word (write bit assignment, see figure 8) is read in via the data input DI, synchronous to the clock input CLK supplied by the µC. The diagnosis word appears in the same way synchronously at the data output DO (read bit assignment, see figure 9), so with the first bit shifted on the DI line the first bit appears on the DO line.

The transmission cycle begins when the TLE 6361 G is selected by the “not chip select” input \overline{CS} (H to L). After the \overline{CS} input returns from L to H, the word that has been read in at the DI line becomes the new control word. The DO output switches to tristate status at

this point, thereby releasing the DO bus circuit for other uses. For details of the SPI timing please refer to figures 10 to 13.

The SPI will be reset to default values given in the following table “write bit meaning” if the RAM good flag of Q_LDO1 indicates a cold start (lower output voltage than 3.3V). The reset will be active as long as the power on reset is present so during the reset delay time at power up no SPI commands are acceptable.

The register content of the SPI - including watchdog timings and reset delay timings - is maintained if the RAM good flag of Q_LDO1 indicates a warm start (i.e. Q_LDO1 did not decrease below 3.3V).

2.12.1 Write mode

The following tables show the bit assignment to the different control functions, how to change settings with the right bit combination and also the default status at power up.

2.12.2 Write mode bit assignment

BIT	DO	D1	D2	D3	D4	D5	D6	D7	D8	D9	D10	D11	D12	D13	D14	D15
Name	WD_OF F1	NOT assigned	T1-control	T2-control	T6-control	T4-control	T5-control	T6-control	sleep	WD_OF F2	reset 1	reset 2	WD 1	WD 2	WD_OF F3	WD-Trig
Default	1	X	0	0	0	0	0	0	1	1	0	0	0	0	1	0

Figure 8 Write Bit assignment

Write Bit meaning

Function	Bit	Combination	Default
Not assigned	D1	X	X
Tracker 1 to 6 - control: turn on/off the individual trackers	D2 D3 D4 D5 D6 D7	0: OFF 1: ON	0
Power down: send device to sleep	D8	0: SLEEP 1: NORMAL	1

Write Bit meaning

Function	Bit	Combination	Default
Reset timing: Reset delay time t_{RES} valid at warm start	D10D11	00: 64ms 10: 32ms 01: 16ms 11: 8ms	00
Window watchdog timing: Open window time t_{OW} and closed window time t_{CW} valid at warm start	D12D13	00: 128ms 10: 64ms 01: 32ms 11: 16ms	00
Window watchdog function: Enable /disable window watchdog	D0D9D14	010: OFF 1xx: ON x0x: ON xx1: ON	111
Window watchdog trigger: Enable / disable window watchdog trigger	D15	0: not triggered 1: triggered	1

2.12.3 Read mode

Below the status information word and the bit assignments for diagnosis are shown.

2.12.3.1 Read mode bit assignment

BIT	D0	D1	D2	D3	D4	D5	D6	D7	D8	D9	D10	D11	D12	D13	D14	D15
Name	ERROR	temp_warn	T1-status	T2-status	T3-status	T4-status	T5-status	T6-status	RAM Good 1	RAM Good 2	WD Window	R-Error1	R-Error2	R-Error3	WD Error	DC/DC status
Default	0	0	0	0	0	0	0	0	0	0	0	0	0	0	0	1

Figure 9 Read Bit assignment

Error bit D0:

The error bit indicates fail function and turns high if the temperature prewarning, the watchdog error is active, further if one RAM good indicates a cold start or if a voltage tracker does not settle within 1ms when it is turned on.

In addition to the error indication by software the ERR pin acts as a hardware error flag.

Read Bit meaning

Function	Type	Bit	Combination	Default
Error indication, explanation see below this table	Latched	D0	0: normal operation 1: fail function	0
Overtemperature warning	Not latched	D1	0: normal operation 1: prewarning	0
Status of Tracker Output Q_T[1:6], only if output is ON	Not latched	D2 D3 D4 D5 D6 D7	1: settled output voltage 0: Tracker turned off or shorted output. Also open load may possibly be indicated as 0. ¹⁾	0
Indication of cold start/warm start, Q_LDO1	Latched	D8	0: cold start 1: warm start	0
Indication of cold start/warm start, Q_LDO2	Latched	D9	0: cold start 1: warm start	0
Indication for open or closed window	Not latched	D10	0: open window 1: closed window	0
Reset condition at output Q_LDO1	Not latched	D11	0: normal operation 1: Reset R1	0
Reset condition at output Q_LDO2	Not latched	D12	0: normal operation 1: Reset R2	0
Reset condition at output Q_LDO3	Not latched	D13	0: normal operation 1: Reset R3	0
Watchdog Error	Latched	D14	0: normal operation 1: WD error	0
DC/DC converter status	Not latched	D15	0: off 1: on	1

¹⁾ Min. load current to avoid '0' signal caused by open load is 2mA.

2.12.4 SPI Timings

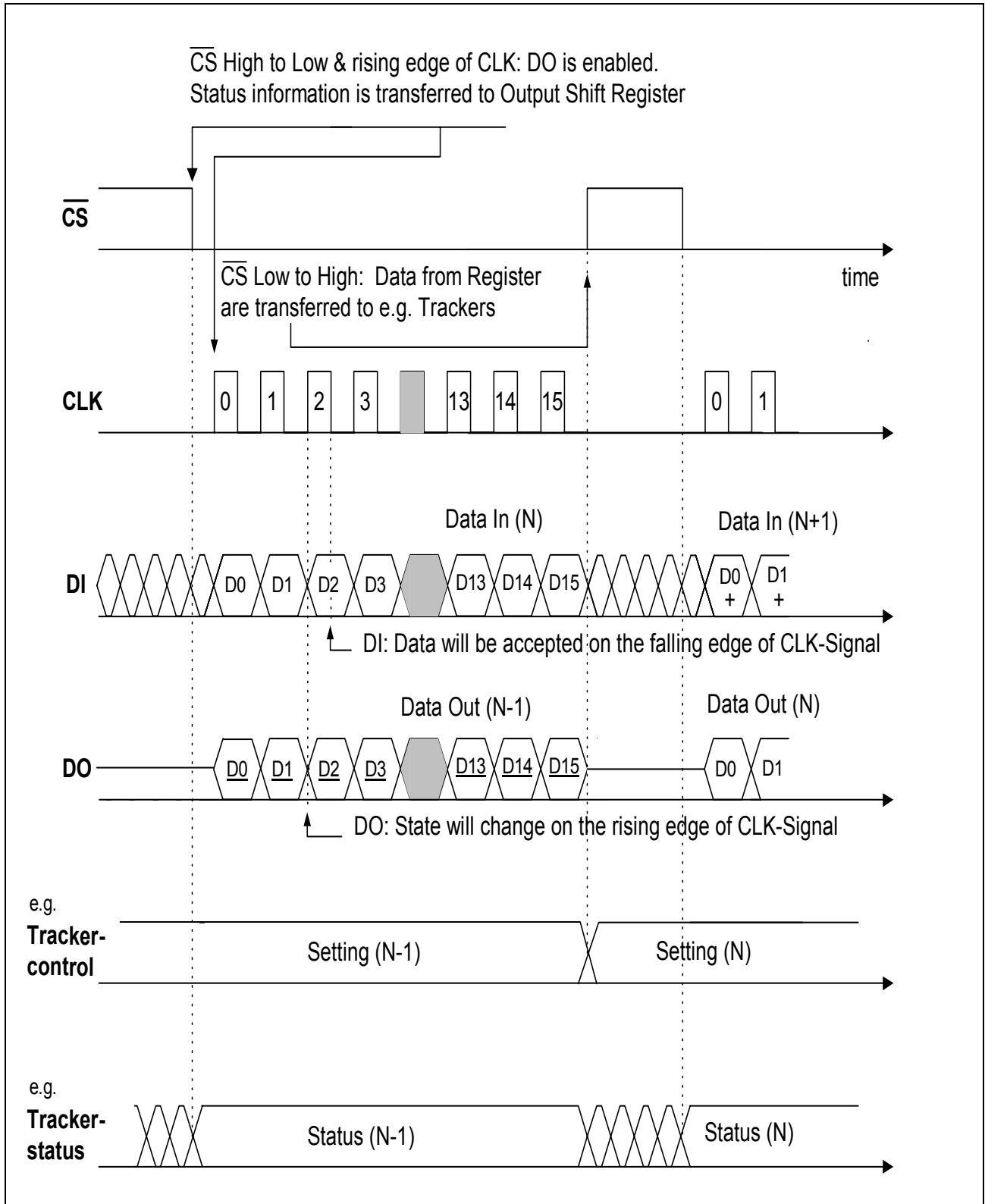

Figure 10 SPI Data Transfer Timing

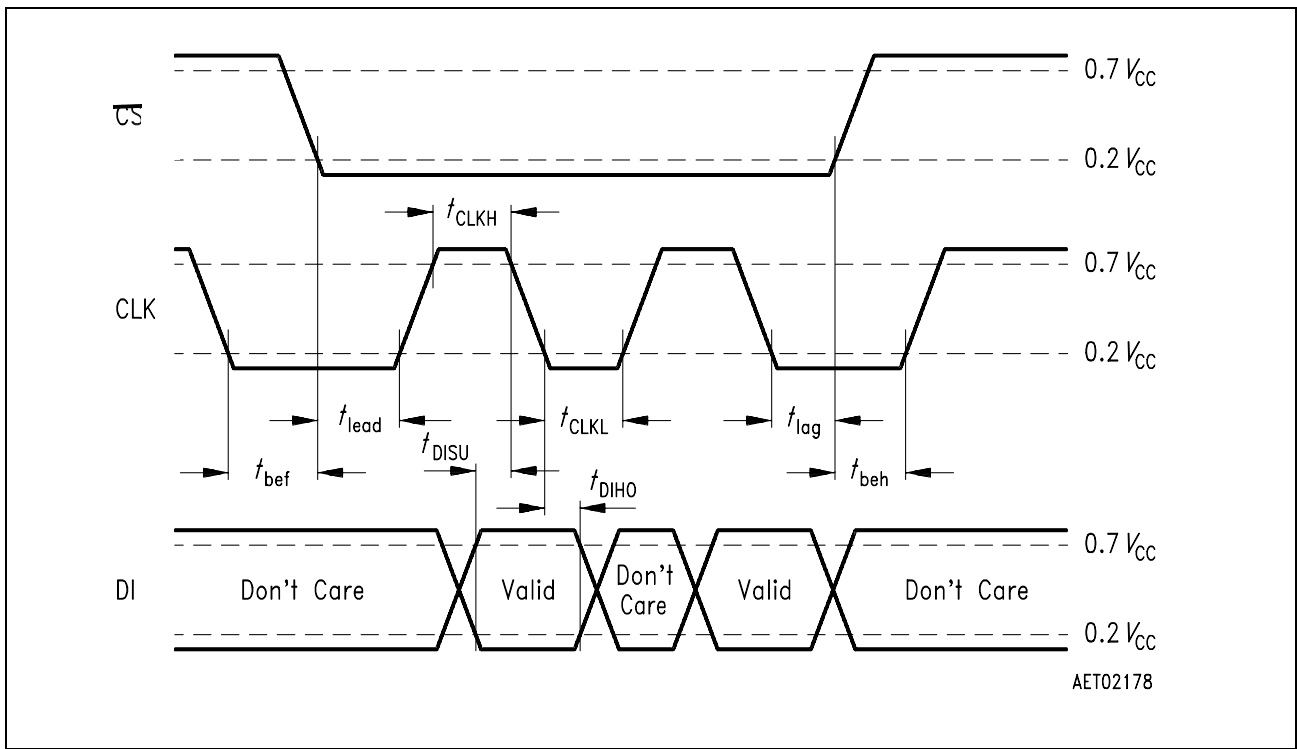

Figure 11 SPI-Input Timing

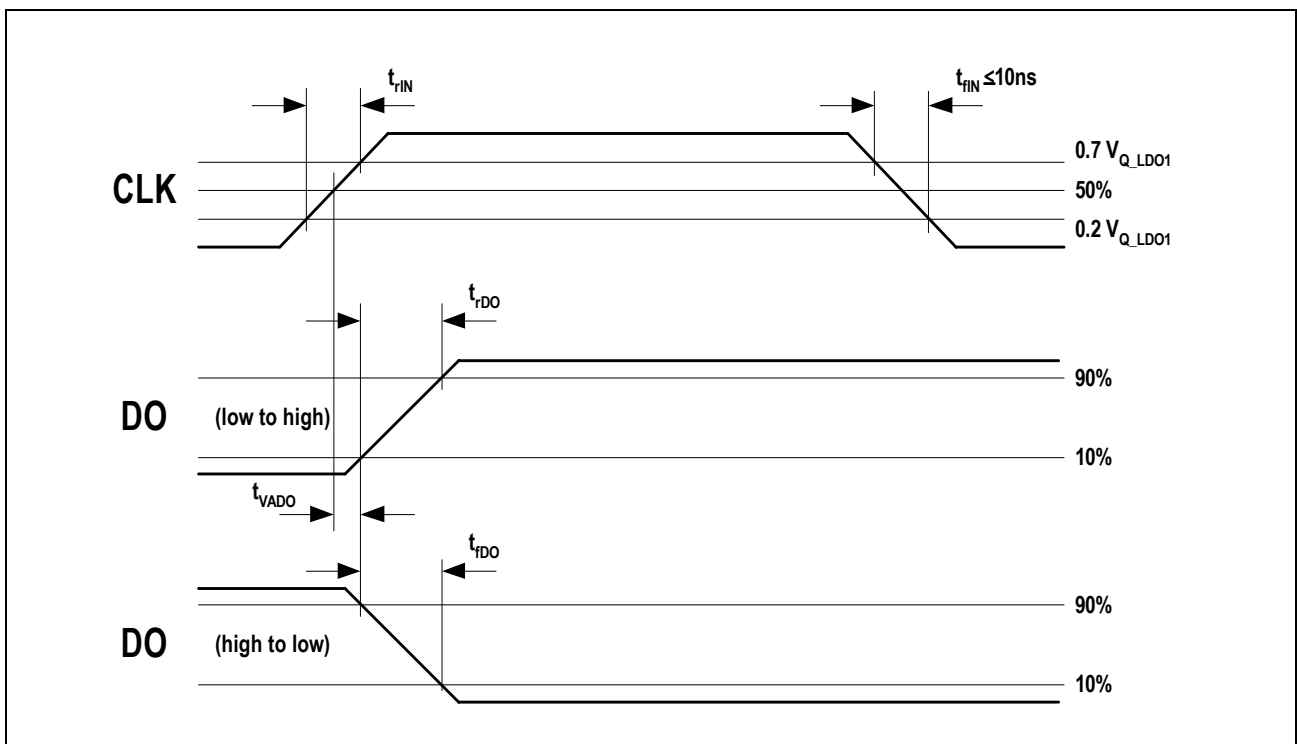

Figure 12 DO Valid Data Delay Time and Valid Time

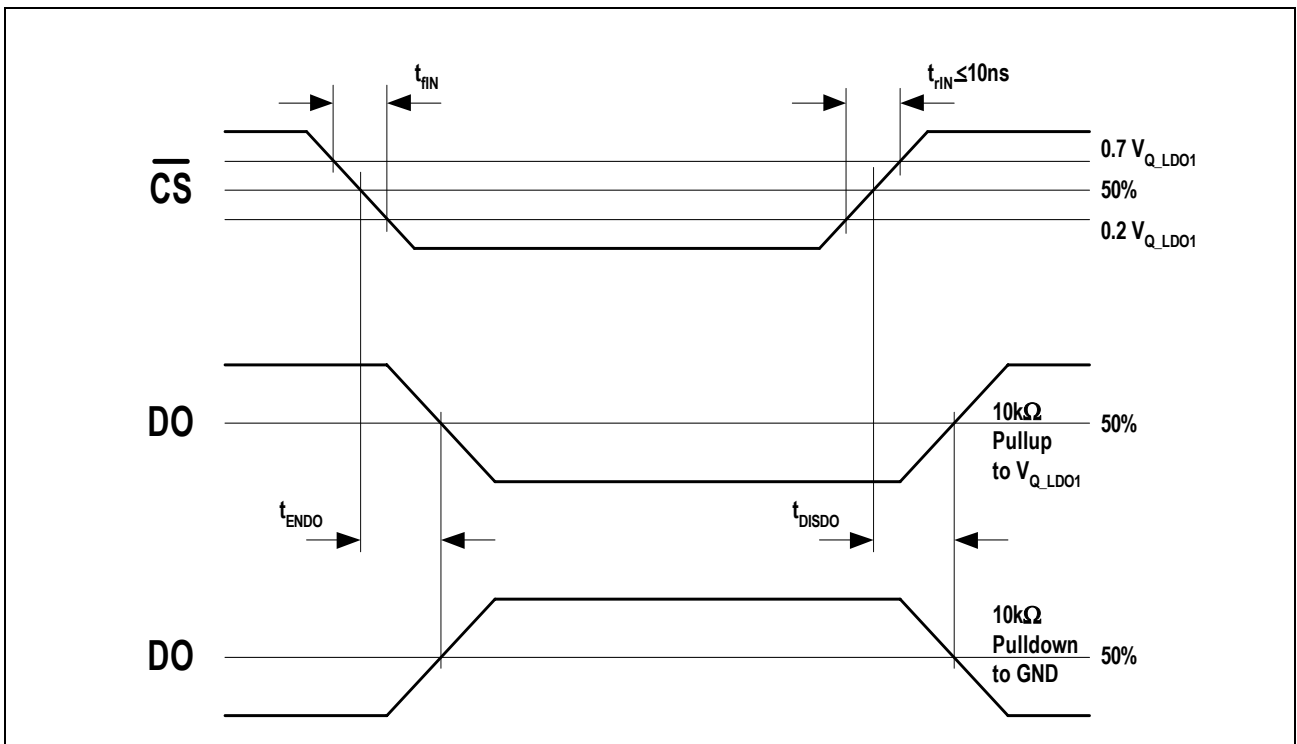

Figure 13 DO Enable and Disable Time

3 Characteristics

3.1 Absolute Maximum Ratings

Item	Parameter	Symbol	Limit Values		Unit	Test Condition
			Min.	Max.		
3.1.1	Supply Voltage Input IN					
	Voltage	V_{VS}	-0.5	60	V	–
	Current	I_{VS}	–	–	–	
3.1.2	Buck-Switch Output SW					
	Voltage	V_{SW}	-2	$V_S+0.5$	V	–
	Current	I_{SW}	–	–	–	
3.1.3	Feedback and Linear Voltage Regulator Input					
	Voltage	V_{FB/L_IN}	-0.5	8	V	–
	Current	I_{FB/L_IN}	–	–	–	
3.1.4	Bootstrap Connector Bootstrap					
	Voltage	$V_{Bootstrap}$	$V_{SW}-0.5V$	$V_{SW}+10V$	V	
	Voltage	$V_{Bootstrap}$	-0.5	70	V	
	Current	$I_{Bootstrap}$	–	–	–	Internally Limited
3.1.5	Boost Input					
	Voltage	V_{Boost}	-0.5	60	V	–
	Current	I_{Boost}	–	–	–	Internally Limited
3.1.6	Slope Control Input Slew					
	Voltage	V_{Slew}	-0.5	6	V	–
	Current	I_{Slew}	–	–	–	Internally Limited
3.1.7	Charge Pump Capacitor Connector C-					
	Voltage	V_{CL}	-0.5	$V_{FB/L_IN}+0.5$	V	
	Current	I_{CL}	-150	+150	mA	

3.1.8	Charge Pump Capacitor Connector C+					
	Voltage	V_{CH}	-0.5	13	V	
	Current	I_{CH}	-150	+150	mA	
3.1.9	Charge Pump Storage Capacitor CCP					
	Voltage	V_{CCP}	-0.5	12	V	
	Current	I_{CCP}	-150	–	mA	
3.1.10	Standby Voltage Regulator output Q_STB					
	Voltage	V_{Q_Stb}	-0.5	6	V	–
	Current	I_{Q_Stb}	–	–	–	Internally limited
3.1.11	Voltage Regulator output voltage Q_LDO1					
	Voltage	V_{Q_LDO1}	-0.5	6	V	–
	Current	I_{Q_LDO1}	–	–	–	Internally limited
3.1.12	Voltage Regulator output voltage Q_LDO2					
	Voltage	V_{Q_LDO2}	-0.5	6	V	–
	Current	I_{Q_LDO2}	–	–	–	Internally limited
3.1.13	Voltage Regulator output voltage Q_LDO3					
	Voltage	V_{Q_LDO3}	-0.5	6	V	–
	Current	I_{Q_LDO3}	–	–	–	Internally limited
3.1.14	Voltage Tracker output voltage Q_T1					
	Voltage	V_{Q_T1}	-4	40	V	–
	Current	I_{Q_T1}	–	–	mA	Internally limited
3.1.15	Voltage Tracker output voltage Q_T2					
	Voltage	V_{Q_T2}	-4	40	V	–
	Current	I_{Q_T2}	–	–	mA	Internally limited
3.1.16	Voltage Tracker output voltage Q_T3					
	Voltage	V_{Q_T3}	-4	40	V	–
	Current	I_{Q_T3}	–	–	mA	Internally limited
3.1.17	Voltage Tracker output voltage Q_T4					
	Voltage	V_{Q_T4}	-4	40	V	–
	Current	I_{Q_T4}	–	–	mA	Internally limited

3.1.18 Voltage Tracker output voltage Q_T5						
	Voltage	V_{Q_T5}	-4	40	V	–
	Current	I_{Q_T5}	–	–	mA	Internally limited
3.1.19 Voltage Tracker output voltage Q_T6						
	Voltage	V_{Q_T6}	-4	40	V	–
	Current	I_{Q_T6}	–	–	mA	Internally limited
3.1.20 Select Input SEL						
	Voltage	V_{SEL}	-0.5	6	V	–
	Current	I_{SEL}	–	–	–	Internally limited
3.1.21 Wake Up Input Wake						
	Voltage	V_{Wake}	-0.5	60	V	–
	Current	I_{Wake}	–	–	–	
3.1.22 Reset Output R1						
	Voltage	V_{R1}	-0.5	6	V	–
	Current	I_{R1}	–	–	–	
3.1.23 Reset Output R2						
	Voltage	V_{R2}	-0.5	6	V	–
	Current	I_{R2}	–	–	–	
3.1.24 Reset Output R3						
	Voltage	V_{R3}	-0.5	6	V	–
	Current	I_{R3}	–	–	–	
3.1.25 SPI Data Input DI						
	Voltage	V_{DI}	-0.5	6	V	–
	Current	I_{DI}	–	–	–	
3.1.26 SPI Data Output DO						
	Voltage	V_{DO}	-0.5	6	V	–
	Current	I_{DO}	–	–	–	Internally limited
3.1.27 SPI Clock Input CLK						
	Voltage	V_{CLK}	-0.5	6	V	–
	Current	I_{CLK}	–	–	–	

3.1.28 SPI Chip Select Not Input \overline{CS}						
	Voltage	$V_{\overline{CS}}$	-0.5	6	V	–
	Current	$I_{\overline{CS}}$	–	–	–	
3.1.29 Error Output Pin						
	Voltage	V_{Error}	-0.5	6	V	–
	Current	I_{Error}	–	–	–	Internally limited
3.1.30 Thermal Resistance						
	Junction-ambient	R_{thja}		37	K/W	¹⁾ PCB heat sink area 300mm ²
	Junction-ambient	R_{thja}		29	K/W	¹⁾ PCB heat sink area 600mm ²
	Junction-case	R_{thjc}	–	2	K/W	
3.1.31 Temperature						
	Junction temperature	T_j	-40	150	°C	
	Junction temperature transient	T_{jt}		175	°C	lifetime=TBD
	Storage temperature	T_{stg}	-50	150	°C	
3.1.32 ESD - Protection (Human Body Model; 1.5kΩ; C=100pF)						
	Electrostatic discharge voltage	V_{ESD}	-1	1	kV	All pins

1) Package mounted on FR4 47x50x1.5mm³; 70μ Cu, zero airflow

Note: Maximum ratings are absolute ratings; exceeding any one of these values may cause irreversible damage to the integrated circuit.

3.2 Functional Range

$-40^{\circ}\text{C} < T_j < 150^{\circ}\text{C}$

Item	Parameter	Symbol	Limit Values		Unit	Condition
			min.	max.		
	Supply Voltage	V_{IN}	5.5		V	To achieve $V_{\text{IN,min}}$ an initial startup with $V_{\text{IN}} > 8\text{V}$ is required;
	Supply Voltage	V_{IN}		60	V	
	Ripple at FB/L_IN	$V_{\text{FB/L_IN}}$ ripple	0	150	mV _{PP}	

Note: Within the functional range the IC can be operated. The electrical characteristics, however, are not guaranteed over this full functional range

3.3 Recommended Operation Range

 $-40^{\circ}\text{C} < T_j < 150^{\circ}\text{C}$

Item	Parameter	Symbol	Limit Values			Unit	Condition
			min.	typ.	max.		
	Buck Inductor	L_B	18		100	μH	¹⁾
	Buck Capacitor	C_B	10			μF	ESR < 0.15 Ω , ceramic capacitor (X7R) recommended ¹⁾
	Bootstrap Capacitor	C_{BTP}	2			% of C_B	
	SLEW resistor	R_{SLEW}	0		20	$\text{k}\Omega$	
	Linear regulator capacitors	C_{Q_LDO1-3}	470			nF	ceramic capacitor (X7R)
	Tracker bypass capacitors	C_{Q_T1-6}	1			μF	ceramic capacitor (X7R)
	SPI rise and fall timings, $\overline{\text{CS}}$, DI, CLK	$t_{r,f}$			200	ns	

¹⁾ $C_{B, \text{min}}$ needs a Buck inductance $L_B=47\mu\text{H}$ to avoid instabilities

3.4 Electrical Characteristics

The electrical characteristics involve the spread of values guaranteed within the specified supply voltage and ambient temperature range. Typical values represent the median values at room temperature, which are related to production processes.

$-40 < T_j < 150 \text{ }^\circ\text{C}$; $V_{IN}=13.5\text{V}$ unless otherwise specified

Item	Parameter	Symbol	Limit Values			Unit	Test Conditions
			min.	typ.	max.		
Buck regulator							
3.4.1	Switching frequency	f_{SW}	280	370	425	kHz	
3.4.2	Current transition time, min., rising edge	$t_{r_L_SW}$		20		ns	$R_{SL}=0\Omega$ ¹⁾
3.4.3	Current transition time, max., rising edge	$t_{r_L_SW}$		100		ns	$R_{SL}=20\text{k}\Omega$ ¹⁾
3.4.4	Current transition time, min., falling edge	$t_{f_L_SW}$		20		ns	$R_{SL}=0\Omega$ ¹⁾
3.4.5	Current transition time, max., falling edge	$t_{f_L_SW}$		100		ns	$R_{SL}=20\text{k}\Omega$ ¹⁾
3.4.6	Voltage rise / fall time	$t_{f_V_SW}$		25		ns	¹⁾
3.4.7	Static on resistance	R_{ON}		160		m Ω	$T_j=25^\circ\text{C}$ in static operation
3.4.8	Static on resistance	R_{ON}		280	400	m Ω	$T_j=150^\circ\text{C}$ in static operation
3.4.9	Current limit	I_{MAX}	1.5		3.2	A	$V_{FB/L_IN}=5.4\text{V}$
3.4.10	Output voltage	V_{OUT}	5.4		6.3	V	$I_{OUT}=0.1\text{A}$ $V_{IN}=13.5\text{V}$
3.4.11	Output voltage	V_{OUT}	5.4		6.05	V	$I_{OUT}=1.5\text{A}$ $V_{IN}=13.5\text{V}$

$-40 < T_j < 150 \text{ }^\circ\text{C}$; $V_{IN}=13.5\text{V}$ unless otherwise specified

Item	Parameter	Symbol	Limit Values			Unit	Test Conditions
			min.	typ.	max.		
3.4.12	Bootstrap charging current at start-up	I_{BTSTR}	80	160	220	μA	
3.4.13	Bootstrap voltage (internal charge pump)	V_{BTSTR}	10		17	V	$V_{FB/L_IN}=6.5\text{V}$, Buck converter off
3.4.14	Bootstrap undervoltage lockout, Buck turn on threshold	$V_{BTSTR, \text{turn on}}$	5		9	V	
3.4.15	Bootstrap undervoltage lockout, hysteresis	$V_{BTSTR, \text{turn on}} - V_{BTSTR, \text{turn off}}$		2.5		V	
3.4.16	Charge pump voltage	V_{CCP}	7.9		11.0	V	$I_{Q_LDO1} = 800\text{mA}$, $V_{FB/L_IN}=6.0\text{V}$, $C_{FLY}=100\text{nF}$, $C_{CCP}=220\text{nF}$
3.4.17	Max. Duty Cycle	duty_{max}		95		%	Switching operation
3.4.18	Min. Duty Cycle	duty_{min}			0	%	Static-off operation
Voltage Regulator Q_LDO1							
3.4.19	Output voltage	V_{Q1}	4.9		5.1	V	$100\text{mA} < I_{Q_LDO1} < 800\text{mA}$
3.4.20	Output voltage	V_{Q1}		5.0		V	$I_{Q_LDO1} = 800\text{mA}$
3.4.21	Load Regulation	ΔV_{Q_LDO1}		40		mV	$100\text{mA} < I_{Q_LDO1} < 800\text{mA}$; $V_{FB/L_IN}=5,5\text{V}$
3.4.22	Current limit	$I_{Q_LDO1\text{limit}}$	800	1050	1400	mA	$V_{Q_LDO1}=4\text{V}$

$-40 < T_j < 150 \text{ }^\circ\text{C}$; $V_{IN}=13.5\text{V}$ unless otherwise specified

Item	Parameter	Symbol	Limit Values			Unit	Test Conditions
			min.	typ.	max.		
3.4.23	Ripple rejection	PSRR1	26	40		dB	$f=330\text{kHz}$; ¹⁾
3.4.24	Output Capacitor	C_{Q_LDO1}	470			nF	Ceramic type, value for stability
Voltage Regulator Q_LDO2							
3.4.25	Output voltage 3.3V	V_{Q_LDO2}	3.14		3.46	V	$50\text{mA} < I_{Q_LDO2} < 400\text{mA}$; 3.3V mode
3.4.26	Output voltage 3.3V	V_{Q_LDO2}		3.32		V	$I_{Q_LDO2} = 400\text{mA}$; 3.3V mode
3.4.27	Output voltage 2.6V	V_{Q_LDO2}	2.500		2.750	V	$50\text{mA} < I_{Q_LDO2} < 400\text{mA}$; 2.6V mode
3.4.28	Output voltage 2.6V	V_{Q_LDO2}		2.62		V	$I_{Q_LDO2} = 400\text{mA}$; 2.6V mode
3.4.29	Load Regulation	ΔV_{Q_LDO2}		50		mV	$50\text{mA} < I_{Q_LDO3} < 400\text{mA}$; $V_{FB/L_IN}=5.5\text{V}$ 3.3V mode
3.4.30	Load Regulation	ΔV_{Q_LDO2}		50		mV	$50\text{mA} < I_{Q_LDO2} < 400\text{mA}$; $V_{FB/L_IN}=5.5\text{V}$ 2.6V mode
3.4.31	Current limit	$I_{Q_LDO2\text{limit}}$	500	650	850	mA	$V_{Q_LDO2} = 2.8\text{V}$; 3.3V mode
3.4.32	Current limit	$I_{Q_LDO2\text{limit}}$	500	650	850	mA	$V_{Q_LDO2} = 2\text{V}$; 2.6V mode
3.4.33	Ripple rejection	PSRR2	26	40		dB	$f=330\text{kHz}$; ¹⁾
3.4.34	Output Capacitor	C_{Q_LDO2}	470			nF	Ceramic type, value for stability
Voltage Regulator Q_LDO3							

$-40 < T_j < 150 \text{ } ^\circ\text{C}$; $V_{IN}=13.5\text{V}$ unless otherwise specified

Item	Parameter	Symbol	Limit Values			Unit	Test Conditions
			min.	typ.	max.		
3.4.35	Output voltage 5V	V_{Q_LDO3}	4.8		5.2	V	$20\text{mA} < I_{Q_LDO3} < 300\text{mA}$; 5V mode
3.4.36	Output voltage 5V	V_{Q_LDO3}		5.0		V	$I_{Q_LDO3} = 300\text{mA}$; 5V mode
3.4.37	Output voltage 3.3V	V_{Q_LDO3}	3.14		3.46	V	$20\text{mA} < I_{Q_LDO3} < 300\text{mA}$; 3.3V mode
3.4.38	Output voltage 3.3V	V_{Q_LDO3}		3.32		V	$I_{Q_LDO3} = 300\text{mA}$; 3.3V mode
3.4.39	Load Regulation	ΔV_{Q_LDO3}		100		mV	$20\text{mA} < I_{Q_LDO3} < 300\text{mA}$; $V_{FB/L_IN} = 5,5\text{V}$ 5V mode
3.4.40	Load Regulation	ΔV_{Q_LDO3}		50		mV	$20\text{mA} < I_{Q_LDO3} < 300\text{mA}$; $V_{FB/L_IN} = 5,5\text{V}$ 3.3V mode
3.4.41	Current limit	I_{Q_LDO3} limit	350	500	600	mA	$V_{Q_LDO3} = 4\text{V}$; 5V mode
3.4.42	Current limit	I_{Q_LDO3} limit	350	500	600	mA	$V_{Q_LDO3} = 2.8\text{V}$; 3.3V mode
3.4.43	Ripple rejection	PSRR3	26	40		dB	$f = 330\text{kHz}$; ¹⁾
3.4.44	Output Capacitor	C_{Q_LDO3}	470			nF	Ceramic type, value for stability
Voltage Tracker Q_T1							
3.4.45	Output voltage tracking accuracy	ΔV_{Q_T1}	-15		5	mV	$V_{Q_T1} - V_{Q_LDO1}$; $1\text{mA} < I_{Q_T1} < 17\text{mA}$
3.4.46	Output voltage tracking accuracy	ΔV_{Q_T1}		-10		mV	$V_{Q_T1} - V_{Q_LDO1}$; $I_{Q_T1} = 17\text{mA}$

$-40 < T_j < 150 \text{ }^\circ\text{C}$; $V_{IN}=13.5\text{V}$ unless otherwise specified

Item	Parameter	Symbol	Limit Values			Unit	Test Conditions
			min.	typ.	max.		
3.4.47	Overshoot threshold	V_{OVQ_T1}		$V_{Q_T1, \text{nom}}$		mV	$I_{Q_T1} = 0\text{mA}$; ¹⁾
3.4.48	Undervoltage threshold	V_{UVQ_T1}		$V_{Q_T1} - 15\text{mV}$		mV	¹⁾
3.4.49	Current limit	$I_{Q_T1 \text{ limit}}$	17		30	mA	$V_{Q_T1}=4\text{V}$
3.4.50	Ripple rejection	PSRR	26			dB	$f=330\text{kHz}$; ¹⁾
3.4.51	Tracker load capacitor	C_{Q_T1}	1			μF	Ceramic type, minimum for stability
Voltage Tracker Q_T2							
3.4.52	Output voltage tracking accuracy	ΔV_{Q_T2}	-15		5	mV	$V_{Q_T2} - V_{Q_LDO1}$; $1\text{mA} < I_{Q_T2} < 17\text{mA}$
3.4.53	Output voltage tracking accuracy	ΔV_{Q_T2}		-10		mV	$V_{Q_T2} - V_{Q_LDO2}$; $I_{Q_T2} = 17\text{mA}$
3.4.54	Overshoot threshold	V_{OVQ_T2}		$V_{Q_T2, \text{nom}}$		mV	$I_{Q_T2} = 0\text{mA}$; ¹⁾
3.4.55	Undervoltage threshold	V_{UVQ_T2}		$V_{Q_T2} - 15\text{mV}$		mV	¹⁾
3.4.56	Current limit	$I_{Q_T2 \text{ limit}}$	17		30	mA	$V_{Q_T2}=4\text{V}$
3.4.57	Ripple rejection	PSRR	26			dB	$f=330\text{kHz}$; ¹⁾
3.4.58	Tracker load capacitor	C_{Q_T2}	1			μF	Ceramic type, minimum for stability
Voltage Tracker Q_T3							

$-40 < T_j < 150 \text{ }^\circ\text{C}$; $V_{IN}=13.5\text{V}$ unless otherwise specified

Item	Parameter	Symbol	Limit Values			Unit	Test Conditions
			min.	typ.	max.		
3.4.59	Output voltage tracking accuracy	ΔV_{Q_T3}	-15		5	mV	$V_{Q_T3}-V_{Q_LDO1}$; $1\text{mA} < I_{Q_T3} < 17\text{mA}$
3.4.60	Output voltage tracking accuracy	ΔV_{Q_T3}		-10		mV	$V_{Q_T3}-V_{Q_LDO3}$; $I_{Q_T3} = 17\text{mA}$
3.4.61	Overvoltage threshold	V_{OVQ_T3}		$V_{Q_T3, \text{nom}}$		mV	$I_{Q_T3} = 0\text{mA}$; ¹⁾
3.4.62	Undervoltage threshold	V_{UVQ_T3}		$V_{Q_T3}-15\text{mV}$		mV	¹⁾
3.4.63	Current limit	$I_{Q_T3 \text{ limit}}$	17		30	mA	$V_{Q_T3}=4\text{V}$
3.4.64	Ripple rejection	PSRR	26			dB	$f=330\text{kHz}$; ¹⁾
3.4.65	Tracker load capacitor	C_{Q_T3}	1			μF	Ceramic type, minimum for stability
Voltage Tracker Q_T4							
3.4.66	Output voltage tracking accuracy	ΔV_{Q_T4}	-15		5	mV	$V_{Q_T4}-V_{Q_LDO1}$; $1\text{mA} < I_{Q_T4} < 17\text{mA}$
3.4.67	Output voltage tracking accuracy	ΔV_{Q_T4}		-10		mV	$V_{Q_T4}-V_{Q_LDO4}$; $I_{Q_T4} = 17\text{mA}$
3.4.68	Overvoltage threshold	V_{OVQ_T4}		$V_{Q_T4, \text{nom}}$		mV	$I_{Q_T4} = 0\text{mA}$; ¹⁾
3.4.69	Undervoltage threshold	V_{UVQ_T4}		$V_{Q_T4}-15\text{mV}$		mV	¹⁾
3.4.70	Current limit	$I_{Q_T4 \text{ limit}}$	17		30	mA	$V_{Q_T4}=4\text{V}$
3.4.71	Ripple rejection	PSSR	26			dB	$f=330\text{kHz}$; ¹⁾

$-40 < T_j < 150 \text{ }^\circ\text{C}$; $V_{IN}=13.5\text{V}$ unless otherwise specified

Item	Parameter	Symbol	Limit Values			Unit	Test Conditions
			min.	typ.	max.		
3.4.72	Tracker load capacitor	C_{Q_T4}	1			μF	Ceramic type, minimum for stability
Voltage Tracker Q_T5							
3.4.73	Output voltage tracking accuracy	ΔV_{Q_T5}	-15		5	mV	$V_{Q_T5}-V_{Q_LDO1}$; $1\text{mA} < I_{Q_T5} < 17\text{mA}$
3.4.74	Output voltage tracking accuracy	ΔV_{Q_T5}		-10		mV	$V_{Q_T5}-V_{Q_LDO5}$; $I_{Q_T5} = 17\text{mA}$
3.4.75	Overvoltage threshold	V_{OVQ_T5}		$V_{Q_T5, \text{nom}}$		mV	$I_{Q_T5} = 0\text{mA}$; ¹⁾
3.4.76	Undervoltage threshold	V_{UVQ_T5}		$V_{Q_T5}-15\text{mV}$		mV	¹⁾
3.4.77	Current limit	$I_{Q_T5 \text{ limit}}$	17		30	mA	$V_{Q_T5}=4\text{V}$
3.4.78	Ripple rejection	PSRR	26			dB	$f=330\text{kHz}$; ¹⁾
3.4.79	Tracker load capacitor	C_{Q_T5}	1			μF	Ceramic type, minimum for stability
Voltage Tracker Q_T6							
3.4.80	Output voltage tracking accuracy	ΔV_{Q_T6}	-15		5	mV	$V_{Q_T6}-V_{Q_LDO1}$; $1\text{mA} < I_{Q_T6} < 17\text{mA}$
3.4.81	Output voltage tracking accuracy	ΔV_{Q_T6}		-10		mV	$V_{Q_T6}-V_{Q_LDO6}$; $I_{Q_T6} = 17\text{mA}$
3.4.82	Overvoltage threshold	V_{OVQ_T6}		$V_{Q_T6, \text{nom}}$		mV	$I_{Q_T6} = 0\text{mA}$; ¹⁾

$-40 < T_j < 150 \text{ }^\circ\text{C}$; $V_{IN}=13.5\text{V}$ unless otherwise specified

Item	Parameter	Symbol	Limit Values			Unit	Test Conditions
			min.	typ.	max.		
3.4.83	Undervoltage threshold	V_{UVQ_T6}		$V_{Q_T6}^-$ 15mV		mV	1)
3.4.84	Current limit	I_{Q_T6} limit	17		30	mA	$V_{Q_T6}=4\text{V}$
3.4.85	Ripple rejection	PSRR	26			dB	$f=330\text{kHz}$; 1)
3.4.86	Tracker load capacitor	C_{Q_T6}	1			μF	Ceramic type, minimum for stability
Standby Regulator							
3.4.87	Output voltage	V_{Q_STB}	2.2	2.4	2.6	V	$0\mu\text{A}$ $<I_{Q_STB}<500\mu\text{A}$
3.4.88	Current limit	I_{Q_STB} limit	1	3	6	mA	$V_{Q_STB}=2\text{V}$
3.4.89	Standby load capacitor	C_{Q_STB}	100			nF	Ceramic type, minimum for stability
Off-Mode							
3.4.90	Supply current from battery	$I_{q,off}$		10	30	μA	$V_{IN}=13.5\text{V}$, $V_{wake}=0\text{V}$, $I_{Q_STB}=0\mu\text{A}$
3.4.91	Supply current from battery	$I_{q,off}$		10	30	μA	$V_{IN}=42\text{V}$, $V_{wake}=0\text{V}$ $I_{Q_STB}=0\mu\text{A}$
3.4.92	Turn on Wake-up threshold	$V_{wake\ th, on}$		2.4	2.8	V	V_{wake} increasing
3.4.93	Turn off Wake-up threshold	$V_{wake\ th, off}$	1.8	2.35		V	V_{wake} decreasing
3.4.94	Wake-up input current	I_{wake}		50	150	μA	$V_{wake}=5\text{V}$
3.4.95	Wake up input on time	$t_{wake,min}$	4	10	50	μs	$V_{wake} >$ $V_{wake\ th, on\ max}$; 1)
Reset R1							

$-40 < T_j < 150 \text{ }^\circ\text{C}$; $V_{IN}=13.5\text{V}$ unless otherwise specified

Item	Parameter	Symbol	Limit Values			Unit	Test Conditions
			min.	typ.	max.		
3.4.96	Reset threshold Q_LDO1	V_{RTH} Q_LDO1, de	4.5	4.65	4.8	V	V_{Q_LDO1} decreasing
3.4.97	Reset threshold Q_LDO1	V_{RTH} Q_LDO1, in	4.55	4.70	4.9	V	V_{Q_LDO1} increasing
3.4.98	Reset output low voltage	V_{R1L}			0.4	V	$I_{R1}=1.6\text{mA}$; $V_{Q_LDO1}=5\text{V}$
3.4.99	Reset output low voltage	V_{R1L}			0.3	V	$I_{R1}=0.3\text{mA}$; $V_{Q_LDO1}=1\text{V}$
34.100	Reset High leakage current	I_{R1H}			1	μA	
Reset R2							
34.101	Reset threshold Q_LDO2	V_{RTH} Q_LDO2, de	2.6	2.8	3.0	V	3.3V mode; V_{Q_LDO2} decreasing
34.102	Reset threshold hysteresis Q_LDO2	V_{RTH} Q_LDO2, in - V_{RTH} Q_LDO2, de		40		mV	3.3V mode
34.103	Reset threshold Q_LDO2	V_{RTH} Q_LDO2, de	2.3	2.4	2.5	V	2.6V mode; V_{Q_LDO2} decreasing
34.104	Reset threshold hysteresis Q_LDO2	V_{RTH} Q_LDO2, in - V_{RTH} Q_LDO2, de		40		mV	2.6V mode
34.105	Reset output low voltage	V_{R2L}			0.4	V	$I_{R2}=1.6\text{mA}$; $V_{Q_LDO2}=2.5\text{V}$
34.106	Reset output low voltage	V_{R2L}			0.3	V	$I_{R2}=0.3\text{mA}$; $V_{Q_LDO2}=1\text{V}$
34.107	Reset High leakage current	I_{R2H}			1	μA	

$-40 < T_j < 150 \text{ }^\circ\text{C}$; $V_{IN}=13.5\text{V}$ unless otherwise specified

Item	Parameter	Symbol	Limit Values			Unit	Test Conditions
			min.	typ.	max.		
Reset R3							
34.108	Reset threshold Q_LDO3	V_{RTH} Q_LDO3, de	2.7	2.85	3.0	V	3.3V mode; V_{Q_LDO3} decreasing
34.109	Reset threshold hysteresis Q_LDO3	V_{RTH} $Q_LDO3, in -$ V_{RTH} Q_LDO3, de		40		mV	3.3V mode
34.110	Reset threshold Q_LDO3	V_{RTH} Q_LDO3, de	4.0	4.2	4.5	V	5V mode; V_{Q_LDO3} decreasing
34.111	Reset threshold hysteresis Q_LDO3	V_{RTH} $Q_LDO3, in -$ V_{RTH} Q_LDO3, de		40		mV	5V mode
34.112	Reset output low voltage	V_{R3L}			0.4	V	$I_{R3}=1.6\text{mA}$; $V_{Q_LDO3}=3.3\text{V}$
34.113	Reset output low voltage	V_{R3L}			0.3	V	$I_{R3}=0.3\text{mA}$; $V_{Q_LDO3}=1\text{V}$
34.114	Reset High leakage current	I_{R3H}			1	μA	
34.115	Reset reaction time	t_{rr}	1	2	10	μs	¹⁾ Valid for R1, R2 and R3
34.116	Reset Delay Norm factor	$t_{NORM,RES}$	0.75	1	1.25	1	
34.117	Reset Delay time	t_{RES}	0.75	1	1.25	$t_{RES(SPI)}$	Valid for R1, R2 and R3; $t_{RES(SPI)}$ is defined by the SPI word (see section 2.12)
RAM Good							
34.118	V_{Q1} threshold	V_{ThQ1}	2.3	2.8	3.3	V	

$-40 < T_j < 150 \text{ }^\circ\text{C}$; $V_{IN}=13.5\text{V}$ unless otherwise specified

Item	Parameter	Symbol	Limit Values			Unit	Test Conditions
			min.	typ.	max.		
34.119	V_{Q2} threshold	$V_{Th Q2}$	1.2	1.4	1.7	V	3.3V mode
34.120	V_{Q2} threshold	$V_{Th Q2}$	1.2	1.4	1.7	V	2.6V mode; ¹⁾
Window Watchdog							
34.121	Closed window time tolerance	t_{CW_tol}	0.75	1	1.25		Multiply with watchdog window time set by SPI to obtain the limits (2.12)
34.122	Open window time tolerance	t_{OW_tol}	0.75	1	1.25		Multiply with watchdog window time set by SPI to obtain the limits (2.12)
34.123	Watchdog reset low time	t_{WRL}		t_{RES}			
34.124	Watchdog reset delay time	t_{SR}		$t_{CW}/2$			
Error Output \overline{ERR}							
34.125	H-output voltage level	$V_{\overline{ERR},H}$	$V_{Q_LDO1} - 2.0$	$V_{Q_LDO1} - 0.7$	–	V	$I_{\overline{ERR}, H} = 1 \text{ mA}$
34.126	L-output voltage level	$V_{\overline{ERR},L}$	–	0.3	0.5	V	$I_{\overline{ERR}, L} = - 1.6 \text{ mA}$
SPI							
34.127	SPI clock frequency	f_{CLK}	0		2.5	MHz	Production test up to 1MHz; 2.5MHz ¹⁾
SPI Input DI							

-40 < T_j < 150 °C; V_{IN}=13.5V unless otherwise specified

Item	Parameter	Symbol	Limit Values			Unit	Test Conditions
			min.	typ.	max.		
34.128	H-input voltage threshold	V _{IH}	–	40	70	% of V _{Q_LDO1}	–
34.129	L-input voltage threshold	V _{IL}	20	36	–	% of V _{Q_LDO1}	–
34.130	Hysteresis of input voltage	V _{IHY}	50	200	500	mV	1)
34.131	Pull down current	I _I	5	25	100	μA	V _{DI} = 0.2 * V _{Q_LDO1}
34.132	Input capacitance	C _I	–	10	15	pF	0 V < V _{Q_LDO1} < 5.25 V
34.133	Input signal rise time	t _r	–	–	200	ns	1)
34.134	Input signal fall time	t _f	–	–	200	ns	1)
SPI Clock Input CLK							
34.135	H-input voltage threshold	V _{IH}	–	40	70	% of V _{Q_LDO1}	–
34.136	L-input voltage threshold	V _{IL}	20	36	–	% of V _{Q_LDO1}	–
34.137	Hysteresis of input voltage	V _{IHY}	50	200	500	mV	1)
34.138	Pull down current	I _I	5	25	100	μA	V _{CLK} = 0.2 * V _{Q_LDO1}
34.139	Input capacitance	C _I	–	10	15	pF	0 V < V _{Q_LDO1} < 5.25 V
34.140	Input signal rise time	t _r	–	–	200	ns	1)
34.141	Input signal fall time	t _f	–	–	200	ns	1)
SPI Chip Select Input CS							

$-40 < T_j < 150 \text{ }^\circ\text{C}$; $V_{IN}=13.5\text{V}$ unless otherwise specified

Item	Parameter	Symbol	Limit Values			Unit	Test Conditions
			min.	typ.	max.		
34.142	H-input voltage threshold	V_{IH}	–	39	70	% of V_{Q_LDO1}	–
34.143	L-input voltage threshold	V_{IL}	20	35	–	% of V_{Q_LDO1}	–
34.144	Hysteresis of input voltage	V_{IHY}	50	200	500	mV	1)
34.145	Pull up current at pin CS	$I_{i,CS}$	– 100	– 25	– 5	μA	$V_{CS}^- = 0.2 * V_{Q_LDO1}$
34.146	Input capacitance	C_i	–	10	15	pF	$0 \text{ V} < V_{Q_LDO1} < 5.25 \text{ V}$
34.147	Input signal rise time	t_r	–	–	200	ns	1)
34.148	Input signal fall time	t_f	–	–	200	ns	1)
Logic Output DO							
34.149	H-output voltage level	V_{DOH}	$V_{Q_LDO1} - 1.0$	$V_{Q_LDO1} - 0.8$	–	V	$I_{DOH} = 1 \text{ mA}$
34.150	L-output voltage level	V_{DOL}	–	0.2	0.4	V	$I_{DOL} = -1.6 \text{ mA}$
34.151	Tri-state leakage current	I_{DO_TRI}	– 10	–	10	μA	$V_{CS}^- = V_{Q_LDO1}$; $0 \text{ V} < V_{DO} < V_{Q_LDO1}$
34.152	Tri-state input capacitance	C_{DO}	–	10	15	pF	$V_{CS}^- = V_{Q_LDO1}$; $0 \text{ V} < V_{Q_LDO1} < 5.25 \text{ V}$
Data Input Timing							
34.153	Clock period	t_{pCLK}	1000	–	–	ns	1)

-40 < T_j < 150 °C; V_{IN}=13.5V unless otherwise specified

Item	Parameter	Symbol	Limit Values			Unit	Test Conditions
			min.	typ.	max.		
34.154	Clock high time	t _{CLKH}	500	–	–	ns	1)
34.155	Clock low time	t _{CLKL}	500	–	–	ns	1)
34.156	Clock low before $\overline{\text{CS}}$ low	t _{bef}	500	–	–	ns	1)
34.157	$\overline{\text{CS}}$ setup time	t _{lead}	500	–	–	ns	1)
34.158	CLK setup time	t _{lag}	500	–	–	ns	1)
34.159	Clock low after $\overline{\text{CS}}$ high	t _{beh}	500	–	–	ns	1)
34.160	DI setup time	t _{DISU}	250	–	–	ns	1)
34.161	DI hold time	t _{DIHO}	250	–	–	ns	1)
Data Output Timing							
34.162	DO rise time	t _{rDO}	–	50	100	ns	C _L = 100 pF
34.163	DO fall time	t _{fDO}	–	50	100	ns	C _L = 100 pF
34.164	DO enable time	t _{ENDO}	–	–	250	ns	low impedance
34.165	DO disable time	t _{DISDO}	–	–	250	ns	high impedance
34.166	DO valid time	t _{VADO}	–	100	250	ns	V _{DO} < 10% V _{DO} > 90% C _L = 100 pF
General							
34.167	Temperature warning flag	T _{J,Flag}		140		°C	2)
34.168	Over Temperature shutdown	T _{J,Shutdown}	150	170	200	°C	2)

$-40 < T_j < 150 \text{ }^\circ\text{C}$; $V_{IN}=13.5\text{V}$ unless otherwise specified

Item	Parameter	Symbol	Limit Values			Unit	Test Conditions
			min.	typ.	max.		
34.169	Over-Temperature shutdown Hysteresis	ΔT_{sd_hys}		30		K	
34.170	DeltaTW to TSD	$T_{J,Shutdown} - T_{J,Flag}$		20		K	

- 1) Specified by design, not subject to production test
- 2) Simulated at wafer test only, not absolutely measured

4 Typical performance characteristics

Buck converter switching frequency vs. junction temperature

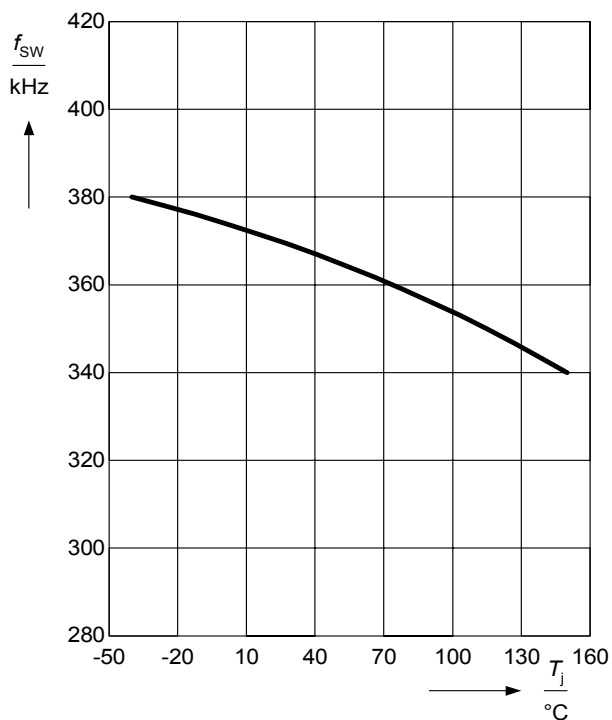

Buck converter output voltage at 1.5A load vs. junction temperature

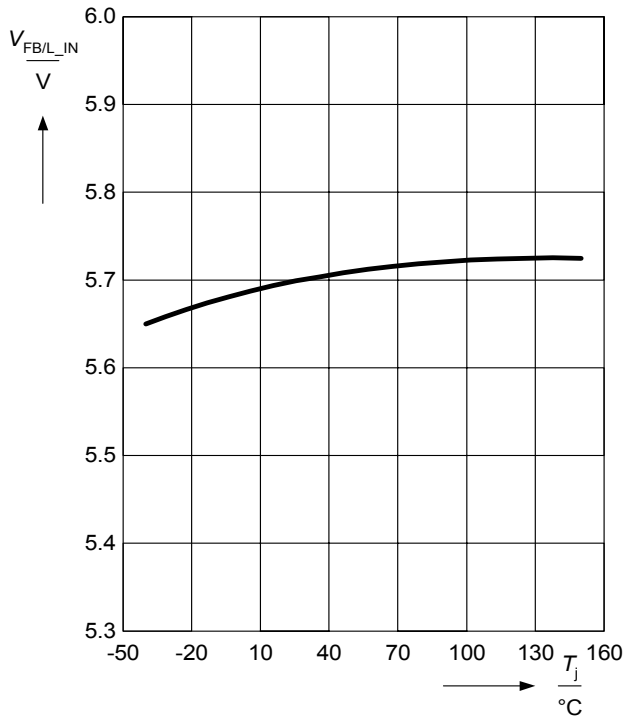

Buck converter current limit vs. junction temperature

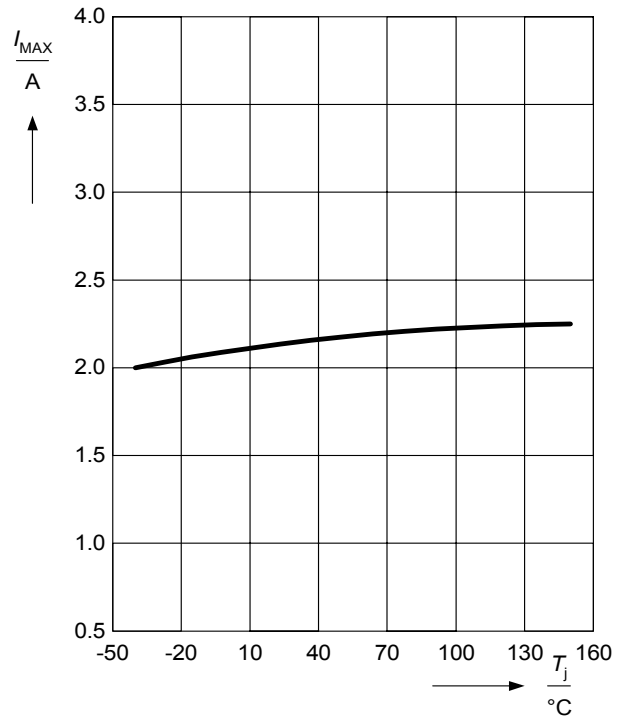

Buck converter DMOS on-resistance vs. junction temperature

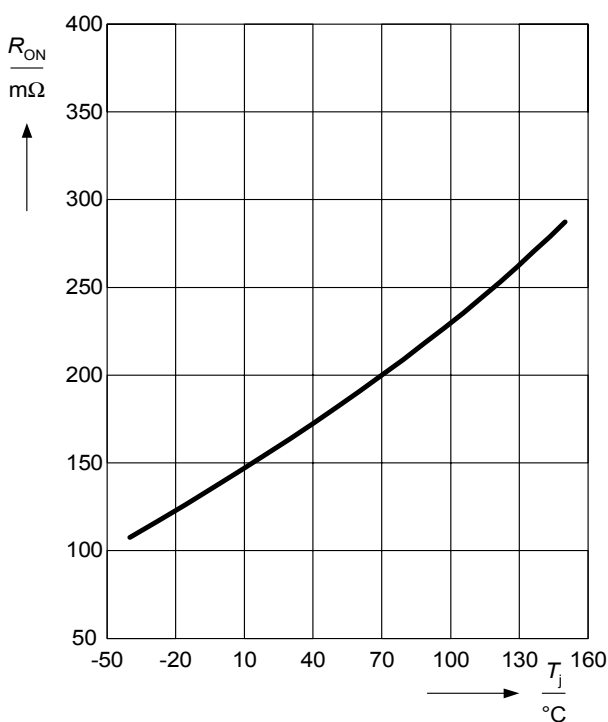

Start-up bootstrap charging current vs. junction temperature

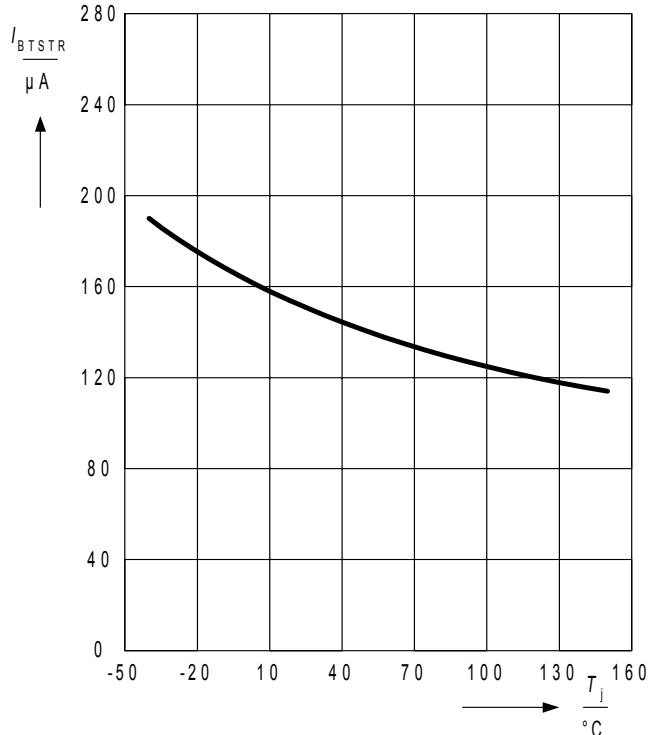

Bootstrap UV lockout, turn on threshold vs. junction temperature

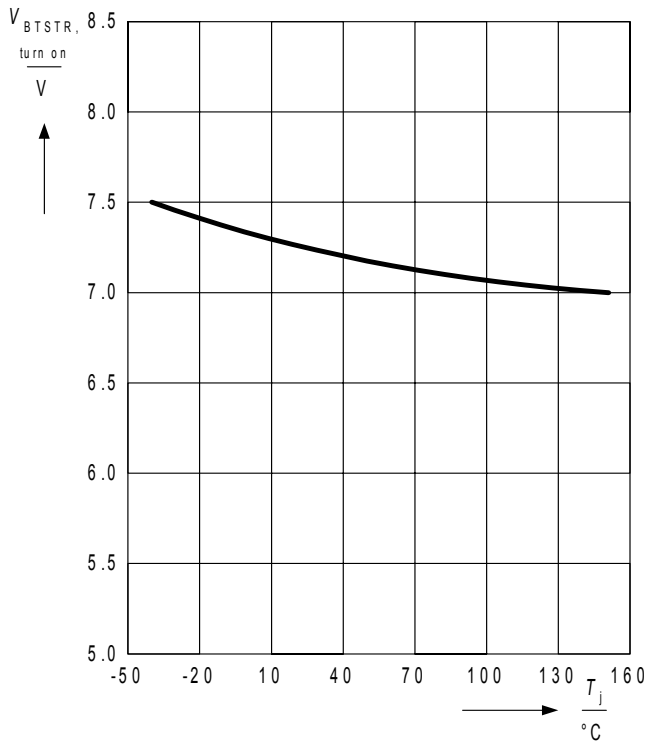

Q_LDO1 output voltage at 800mA load vs. junction temperature

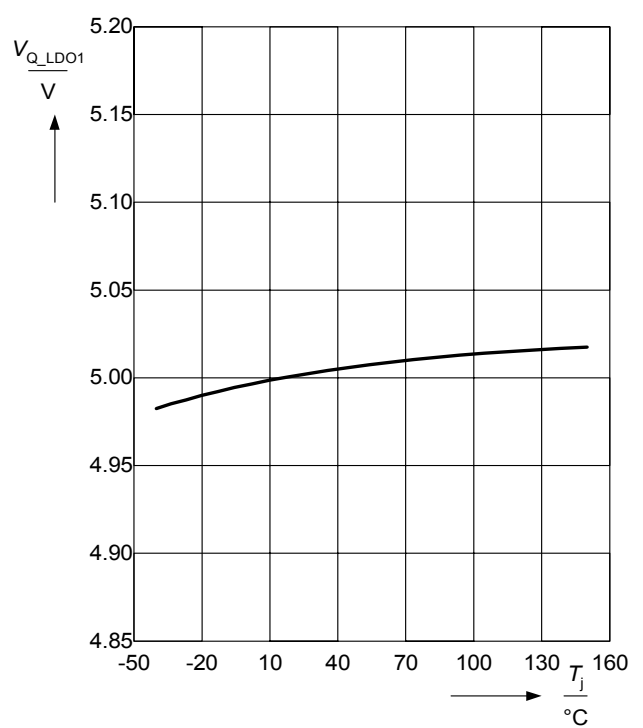

Device wake up thresholds vs. junction temperature

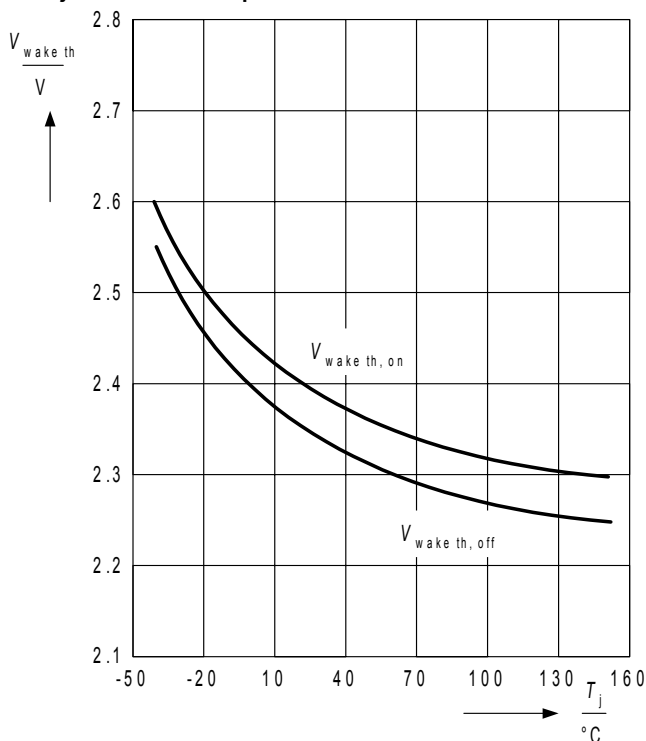

Reset1 threshold at decreasing V_LDO1 vs. junction temperature

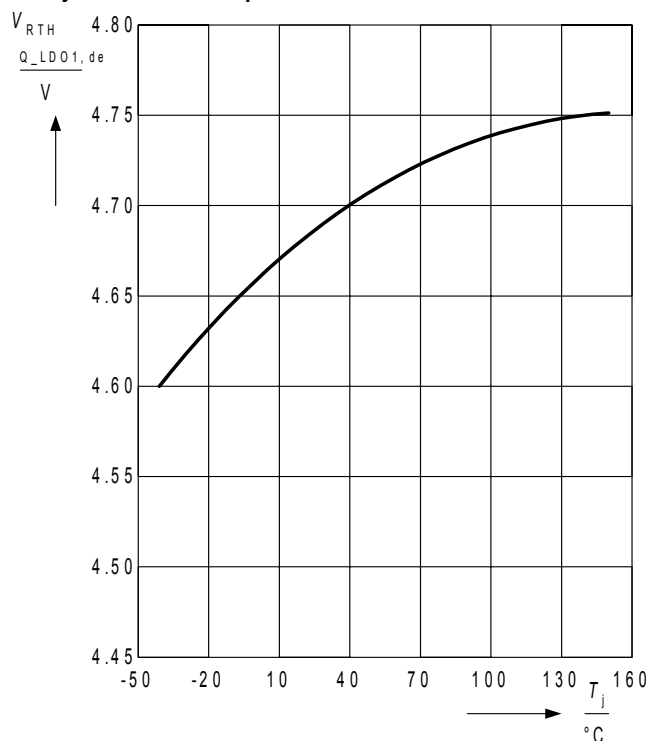

Q_LDO1 current limit vs. junction temperature

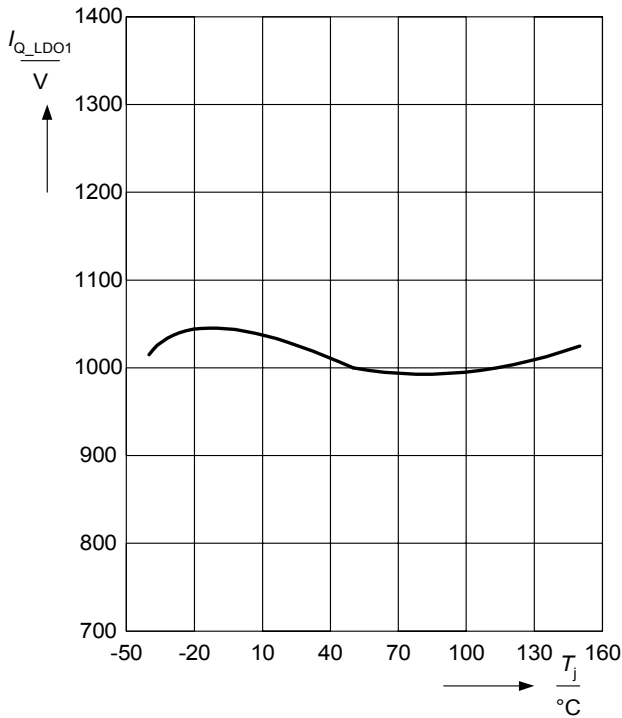

Q_LDO2 current limit (2.6V mode) vs. junction temperature

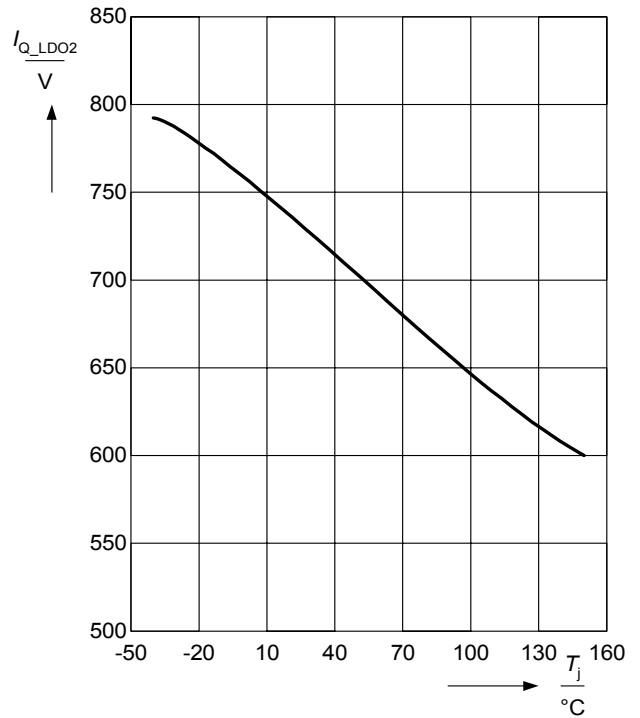

Q_LDO2 output voltage at 400mA load (2.6V mode) vs. junction temperature

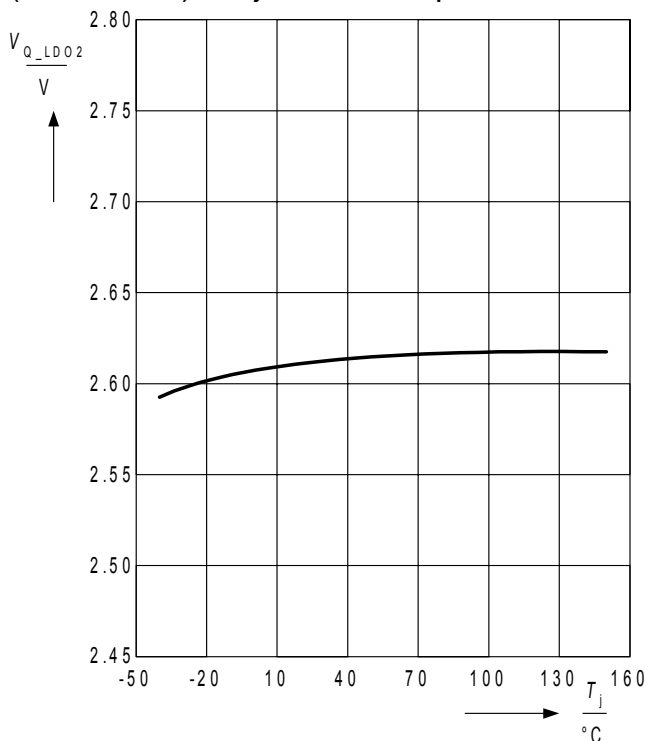

Q_LDO3 output voltage at 300mA load (3.3V mode) vs. junction temperature

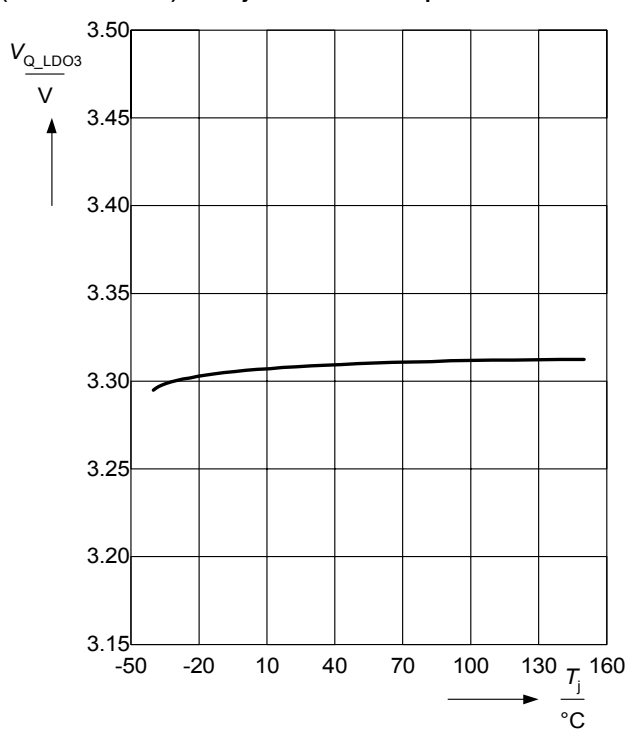

Reset2 threshold at decreasing V_LDO2 (2.6V mode) vs. junction temperature

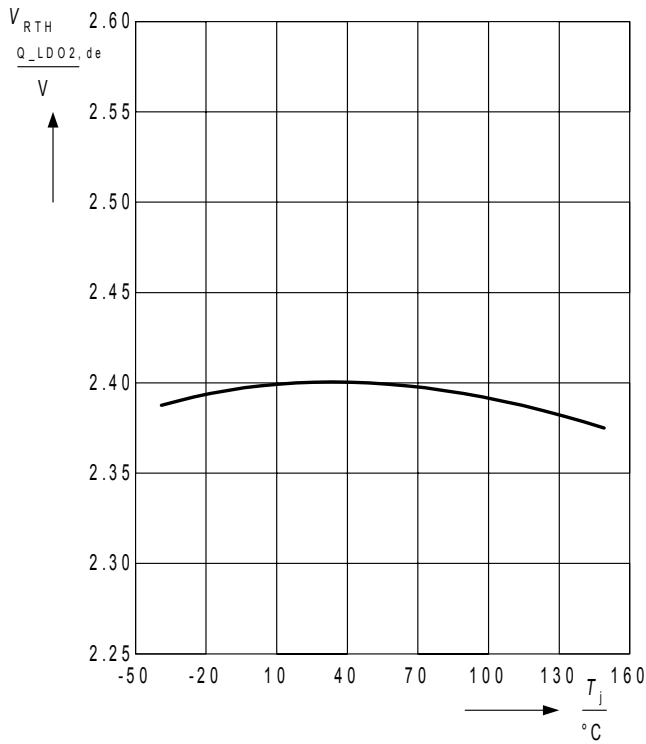

Reset3 threshold at decreasing V_LDO3 (3.3V mode) vs. junction temperature

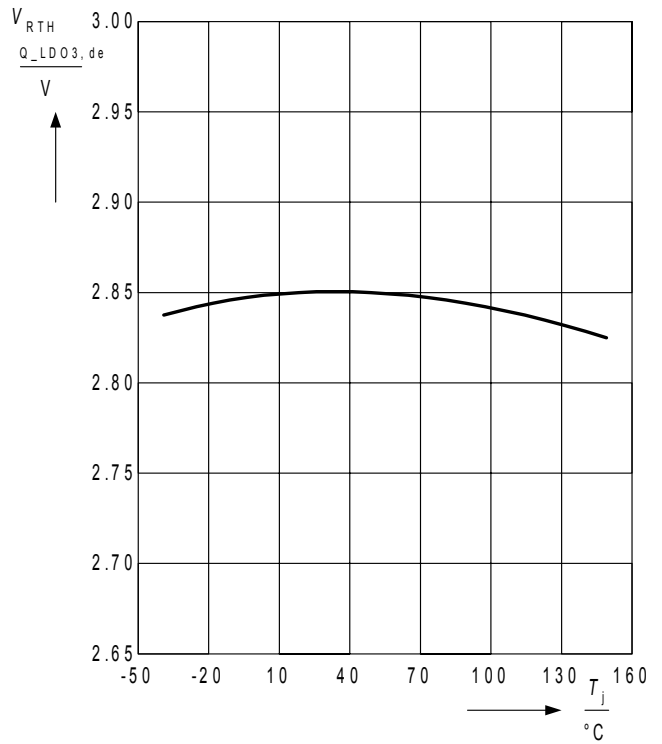

Q_LDO3 current limit (3.3V mode) vs. junction temperature

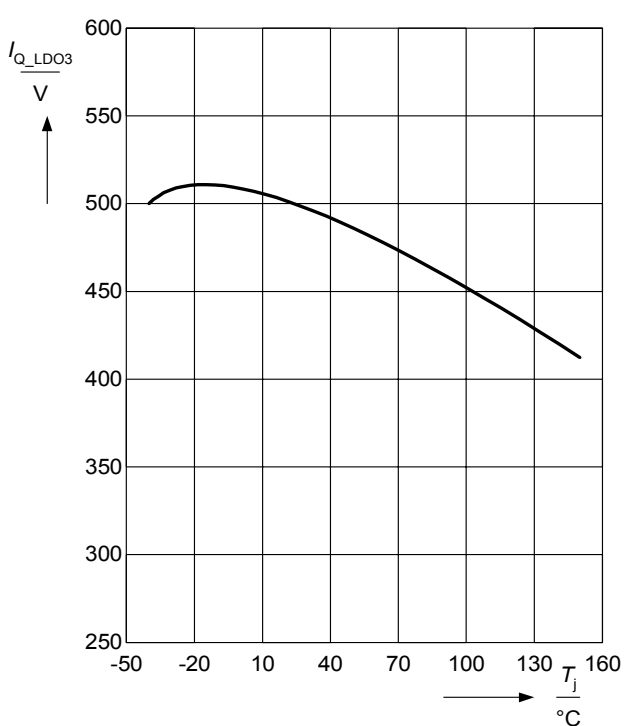

Tracker current limit vs. junction temperature

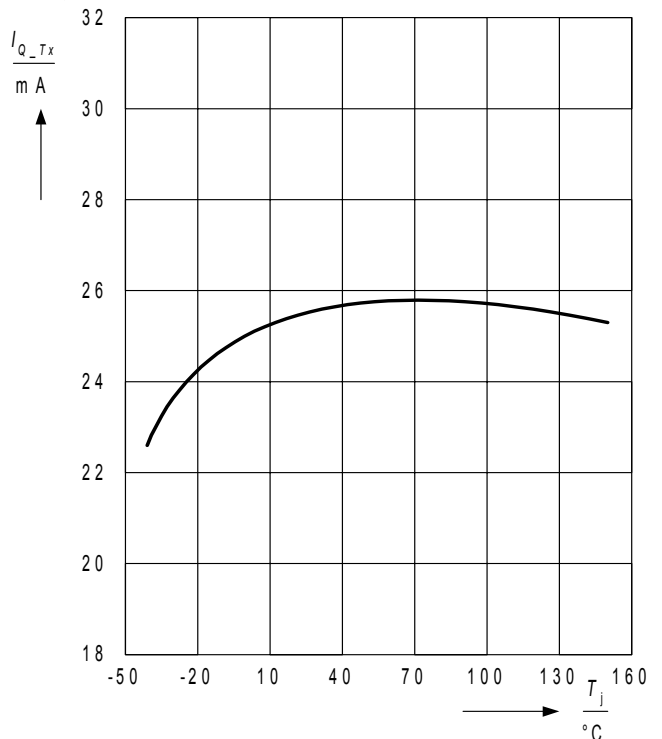

Tracker accuracy with respect to V_LDO1 vs. junction temperature

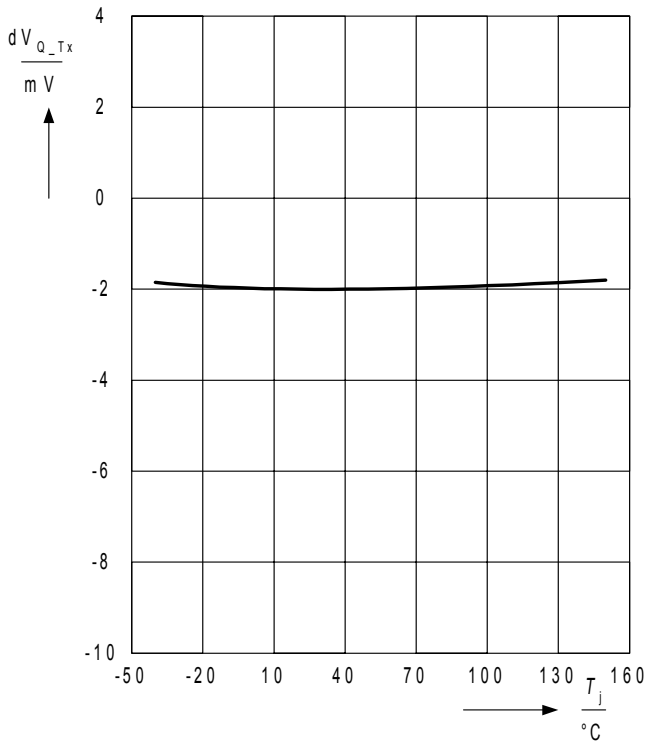

Q_STB current limit vs. junction temperature

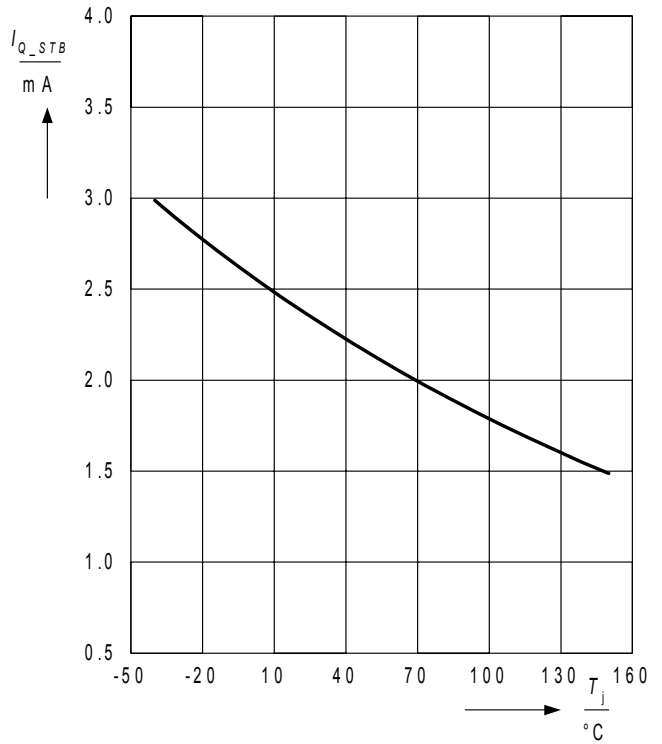

Q_STB output voltage at 500µA load vs. junction temperature

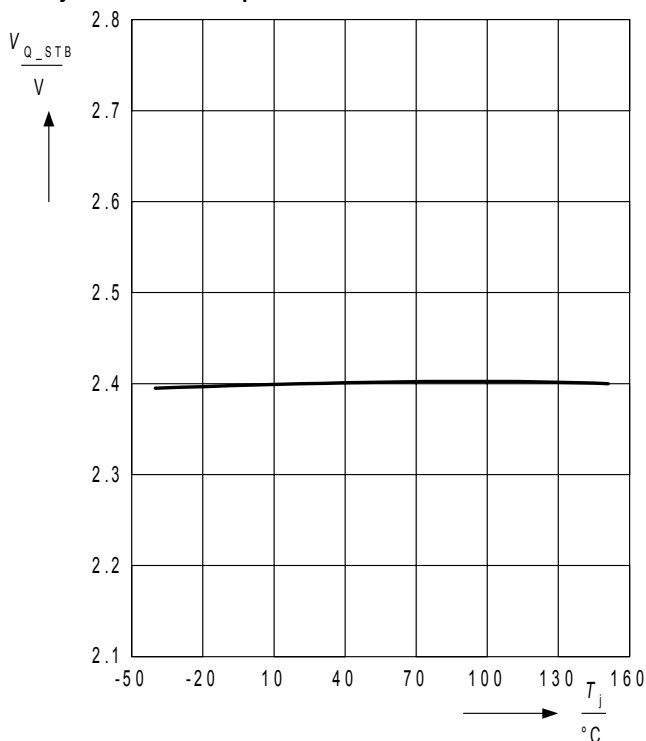

Device current consumption in off mode vs. junction temperature

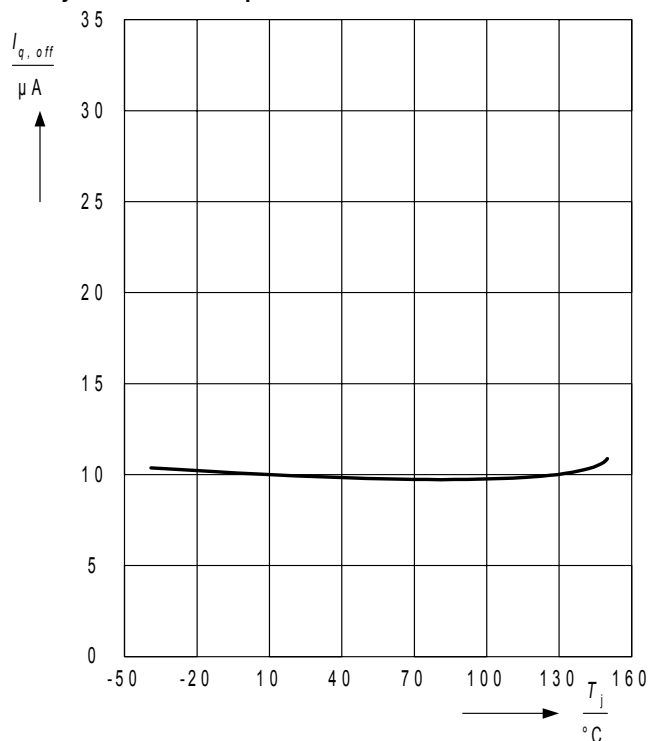

5 Application Information

5.1 Application Diagram

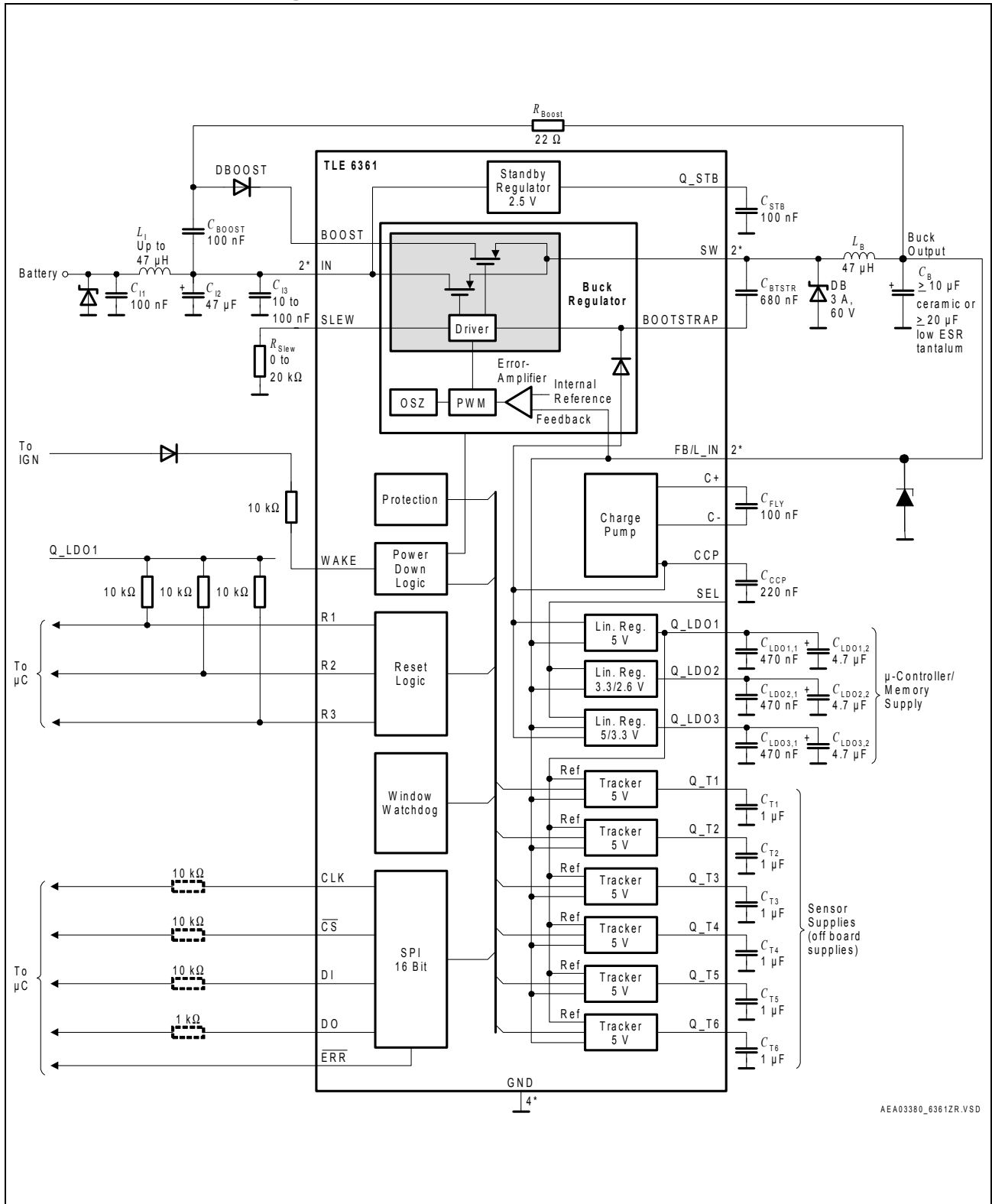

AEA03380_63612R.VSD

Figure 14 Application Diagram

5.2 Buck converter circuit

A typical choice of external components for the buck converter is given in figure 14. For basic operation of the buck converter the input capacitor C_{I2} , the bootstrap capacitor C_{BTP} , the catch diode D_B , the inductance L_B , the output capacitor C_B and the charge pump capacitors C_{FLY} and C_{CCP} are necessary.

The additional components shown on top of the circuit lower the electromagnetic emission (L_I , C_{I1} , C_{I3} , R_{Slew}) and the switching losses (R_{Boost} , C_{Boost} , D_{Boost}). For 12V battery systems the switching loss minimization feature might not be used. In that case the Boost pin (33) is connected directly to the IN pins (32, 30) and the components R_{Boost} , C_{Boost} and D_{Boost} are left away

5.2.1 Buck inductance (L_B) selection:

The inductance value determines together with the input voltage, the output voltage and the switching frequency the current ripple which occurs during normal operation of the step down converter. This current ripple is important for the all over ripple at the output of the switching converter.

As a rule of thumb this current ripple ΔI is chosen between 10% and 50% of the load current.

$$L = \frac{(V_I - V_{OUT}) \cdot V_{OUT}}{f_{SW} \cdot V_I \cdot \Delta I}$$

For optimum operation of the control loop of the Buck converter the inductance value should be in the range indicated in section 3.3, recommended operation range.

When picking finally the inductance of a certain supplier (Epcos, Coilcraft etc.) the saturation current has to be considered. With a maximum current limit of the Buck converter of 3.2A an inductance with a minimum saturation current of 3.2A has to be chosen.

5.2.2 Buck output capacitor (C_B) selection:

The choice of the output capacitor effects straight to the minimum achievable ripple which is seen at the output of the buck converter. In continuous conduction mode the ripple of the output voltage equals:

$$V_{\text{Ripple}} = \Delta I \cdot \left(R_{\text{ESRCB}} + \frac{1}{8 \cdot f_{\text{SW}} \cdot C_B} \right)$$

From the formula it is recognized that the ESR has a big influence in the total ripple at the output, so ceramic types or low ESR tantalum capacitors are recommended for the application.

One other important thing to note are the requirements for the resonant frequency of the output LC-combination. The choice of the components L and C have to meet also the specified range given in section 3.3 otherwise instabilities of the regulation loop might occur.

5.2.3 Input capacitor (C_{I2}) selection:

At high load currents, where the current through the inductance flows continuously, the input capacitor is exposed to a square wave current with its duty cycle V_{OUT}/V_I . To prevent a high ripple to the battery line a capacitor with low ESR should be used. The maximum RMS current which the capacitor has to withstand is calculated to:

$$I_{\text{RMS}} = I_{\text{LOAD}} \cdot \sqrt{\frac{V_{\text{OUT}}}{V_{\text{IN}}}} \cdot \sqrt{1 + \frac{1}{3} \cdot \left(\frac{\Delta I}{2 \cdot I_{\text{LOAD}}} \right)^2}$$

5.2.4 Freewheeling diode / catch diode (D_B)

For lowest power loss in the freewheeling path Schottky diodes are recommended. With those types the reverse recovery charge is negligible and a fast handover from freewheeling to forward conduction mode is possible. Depending on the application (12V battery systems) 40V types could be also used instead of the 60V diodes.

A fast recovery diode with recovery times in the range of 30ns can be also used if smaller junction capacitance values (smaller spikes) are desired, the slew resistor should be set in this case between 10 and 20k Ω .

5.2.5 Bootstrap capacitor (C_{BTP})

The voltage at the Bootstrap capacitor does not exceed 15V, a ceramic type with a minimum of 2% of the buck output capacitance and voltage class 16V would be sufficient.

5.2.6 External charge pump capacitors (C_{FLY} , C_{CCP})

Out of the feedback voltage the charge pump generates a voltage between 8 and 10V. The fly capacitor connected between C+ and C- is charged with the feedback voltage level and discharged to achieve the (almost) double voltage level at CCP. C_{FLY} is chosen to 100nF and C_{CCP} to 220nF, both ceramic types.

The connection of CCP to a voltage source of e.g. 7V (take care of the maximum ratings!) via a diode improves the start-up behavior at very low battery voltage. The diode with the cathode on CCP has to be used in order to avoid any influence of the voltage source to the device's operation and vice versa.

5.2.7 Input filter components for reduced EME (C_{I1} , C_{I2} , C_{I3} , L_I , R_{Slew})

At the input of Buck converters a square wave current is observed causing electromagnetic interference on the battery line. The emission to the battery line consists on one hand of components of the switching frequency (fundamental wave) and its harmonics and on the other hand of the high frequency components derived from the current slope. For proper attenuation of those interferers a π -type input filter structure is recommended which is built up with inductive (L_I) and capacitive components (C_{I1} , C_{I2} , C_{I3}). The inductance can be chosen up to the value of the Buck converter inductance, higher values might not be necessary, C_{I1} and C_{I3} should be ceramic types and for C_{I2} an input capacitance with very low ESR should be chosen and placed as close to the input of the Buck converter as possible.

Inexpensive input filters show due to their parasitics a notch filter characteristic, which means basically that the lowpass filter acts from a certain frequency as a highpass filter and means further that the high frequency components are not attenuated properly. For that reason the TLE 6361 G offers the possibility of current slope adjustment. The current transition time can be set by the external slew resistor to times between 20ns and 80ns by varying the resistor value between 0Ω (fastest transition) and $20k\Omega$ (slowest transition).

5.2.8 Feedback circuit for minimum switching loss (R_{Boost} , C_{Boost} , D_{Boost})

To decrease the switching losses to a minimum the external components R_{Boost} , C_{Boost} and D_{Boost} are needed. The current through the feedback resistor R_{Boost} is about a few mA where the Diode D_{Boost} and the capacitor C_{Boost} run a part of the load current.

If this feature is not needed the three components are not needed and the Boost pin (33) can be connected directly to the IN pins(32, 30).

5.3 Reverse polarity protection

The Buck converter is due to the parasitic source drain diode of the DMOS not reverse polarity protected. Therefore, as an example, the reverse polarity diode is shown in the application circuit, in general the reverse polarity protection can be done in different ways.

5.4 Linear voltage regulators ($C_{LDO1, 2, 3}$)

As indicated before the linear regulators show stable operation with a minimum of 470nF ceramic capacitors. To avoid a high ripple at the output due to load steps this output cap might have to be increased to some few μ F capacitors.

5.5 Linear voltage trackers ($C_{T1,2,3,4,5,6}$)

The voltage trackers require at their outputs 1 μ F ceramic capacitors each to avoid some oscillation at the output. If needed the tracker outputs can be connected in parallel, in that the output capacitor increases linear according to the number of parallel outputs.

5.6 Reset outputs (R1,2,3)

The undervoltage/watchdog reset outputs are open drain structures and require external pull up resistors in the range of 10k Ω to the μ C I/O voltage rail.

5.7 Components recommendation - overview

Device	Type	Supplier	Remark
L _I	B82479 series	EPCOS	10-1000 μ H; 4.3-0.56A
	B82464-A4 series	EPCOS	1-1000 μ H; 6.8-0.3A
	DO3340P series	Coilcraft	10-1000 μ H; 8.0-0.8A
	DO5022P series	Coilcraft	1-1000 μ H; 20.0-1.0A
	DS5022P series	Coilcraft	10-1000 μ H; 8.0-0.8A
	SLF1275T-330M3R2	TDK	33 μ H, 3.2A
C _{I1}	Ceramic	various	100nF, 60V
C _{I2}	Low ESR tantalum	various	47 μ F, 60V
C _{I3}	Ceramic	various	10nF to 100nF, 60V
D _{Boost}	S3B	various	
L _B	B82479 series	EPCOS	10-1000 μ H; 4.3-0.56A
	B82464-A4 series	EPCOS	1-1000 μ H; 6.8-0.3A
	DO3340P series	Coilcraft	10-1000 μ H; 8.0-0.8A
	DO5022P series	Coilcraft	1-1000 μ H; 20.0-1.0A
	DS5022P series	Coilcraft	10-1000 μ H; 8.0-0.8A
C _{BTP}	Ceramic	various	100nF, 10V
D _B	MBRD360	Motorola	Schottky, 60V, 3A
	MBRD340	Motorola	Schottky, 40V, 3A
	SS34	various	Schottky, 40V, 3A
C _B	B45197-A2226	EPCOS	Low ESR Tantalum, 22 μ F, 10V, C-case
	2 * LMK316BJ475ML	Taiyo Yuden	Ceramic X7R, 4.7 μ F, 10V
	C3216X7R1C106M	TDK	Ceramic X7R, 10 μ F, 16V
	TPSC476K010R350	AVX	Low ESR Tantalum, 47 μ F, 10V, C-case
C _{LDOx}	Ceramic	various	470nF, 10V
C _{Tx}	Ceramic	various	1 μ F, 60V

5.8 Layout recommendation

The most sensitive points for Buck converters - when considering the layout - are the nodes at the input and the output of the Buck switch, the DMOS transistor.

For proper operation the external catch diode and Buck inductance have to be connected as close as possible to the SW pins (29, 31). Best suitable for the connection of the cathode of the Schottky diode and one terminal of the inductance would be a small plain located next to the SW pins.

The GND connection of the catch diode must be also as short as possible. In general the GND level should be implemented as surface area over the whole PCB as second layer, if necessary as third layer.

The pin FB/L_IN is sensitive to noise. With an appropriate layout the Buck output capacitor helps to avoid noise coupling to this pin. Also filtering of steep edges at the supply voltage pin e.g. as shown in the application diagram is mandatory. C_{12} may either be a low ESR Tantalum capacitor or a ceramic capacitor. A minimum capacitance of $10\mu\text{F}$ is recommended for C_{12} .

To obtain the optimum filter capability of the input π -filter it has to be located also as close as possible to the IN pins, at least the ceramic capacitor C_{13} should be next to those pins.

Package Outlines

P-DSO-36-12

SMD = Surface Mounted Device

Dimensions in mm

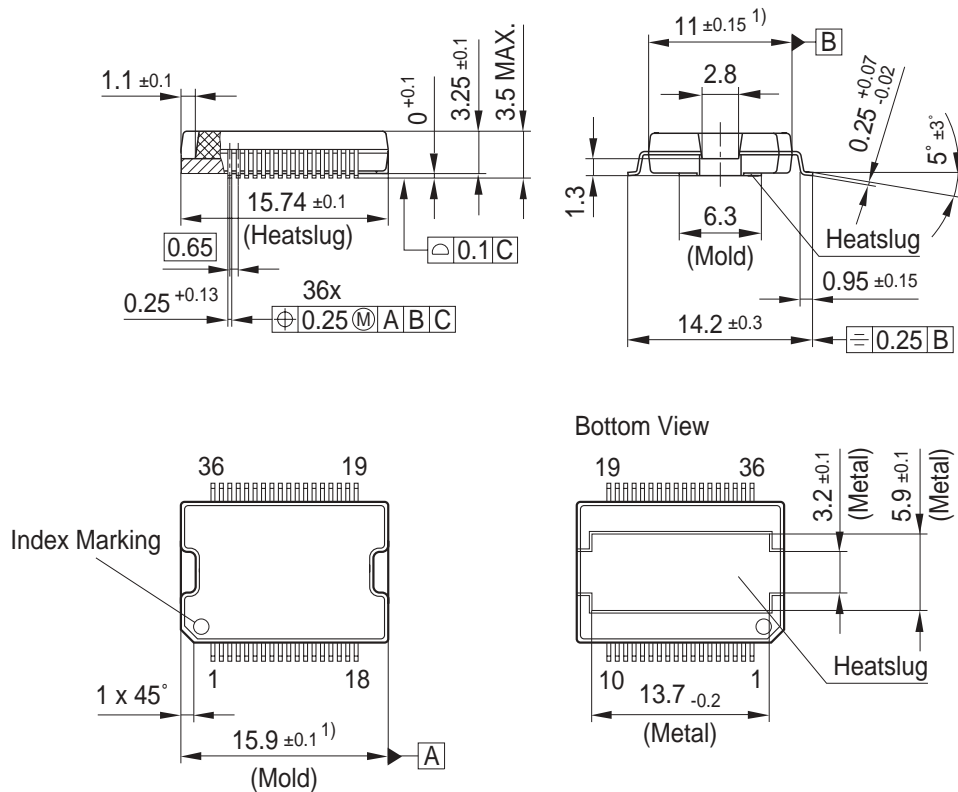

¹⁾ Does not include plastic or metal protrusion of 0.15 max. per side

see also: <http://www.infineon.com> -> Products -> Packages



Edition 2004-09

**Published by Infineon Technologies AG,
St.-Martin-Strasse 53,
81669 München, Germany**

**© Infineon Technologies AG 2/28/05.
All Rights Reserved.**

Attention please!

The information herein is given to describe certain components and shall not be considered as a guarantee of characteristics.

Terms of delivery and rights to technical change reserved.

We hereby disclaim any and all warranties, including but not limited to warranties of non-infringement, regarding circuits, descriptions and charts stated herein.

Information

For further information on technology, delivery terms and conditions and prices please contact your nearest Infineon Technologies Office (www.infineon.com).

Warnings

Due to technical requirements components may contain dangerous substances. For information on the types in question please contact your nearest Infineon Technologies Office.

Infineon Technologies Components may only be used in life-support devices or systems with the express written approval of Infineon Technologies, if a failure of such components can reasonably be expected to cause the failure of that life-support device or system, or to affect the safety or effectiveness of that device or system. Life support devices or systems are intended to be implanted in the human body, or to support and/or maintain and sustain and/or protect human life. If they fail, it is reasonable to assume that the health of the user or other persons may be endangered.