



## Features

- Adjustable output voltage or 1.5V, 1.8V, 2.6V, 3.3 V, 5.0V output voltage
- 1.0 A output current
- Low dropout voltage, typ. 1 V
- Short circuit protection
- Overtemperature protection
- Wide operating range up to 40 V
- Wide temperature range of  $T_j = -40$  to  $150$  °C
- Suitable for use in automotive electronics
- Green Product (RoHS compliant)
- AEC Qualified



## Functional Description

The TLE 4284 is a monolithic integrated NPN type voltage regulator that can supply loads up to 1.0 A. The chip is housed in a surface mounted PG-TO252-3-11 package (DPAK). It is designed to supply microprocessor systems or other loads under the severe conditions of automotive applications and therefore it is equipped with additional protection against overload, short circuit and overtemperature.

An input voltage  $V_I$  in the range of  $(V_Q + V_{DR}) < V_I < 40$  V is regulated to  $V_Q$ . The dropout voltage  $V_{DR}$  ranges from 1.1 V to 1.4 V depending on the load current level.

The device operates in the temperature range of  $T_j = -40$  to  $150$  °C.

Type	Package	Marking
TLE 4284 DV	PG-TO252-3-11	4284V
TLE 4284 DV15	PG-TO252-3-11	4284V15
TLE 4284 DV18	PG-TO252-3-11	4284V18
TLE 4284 DV26	PG-TO252-3-11	4284V26
TLE 4284 DV33	PG-TO252-3-11	4284V33
TLE 4284 DV50	PG-TO252-3-11	4284V50

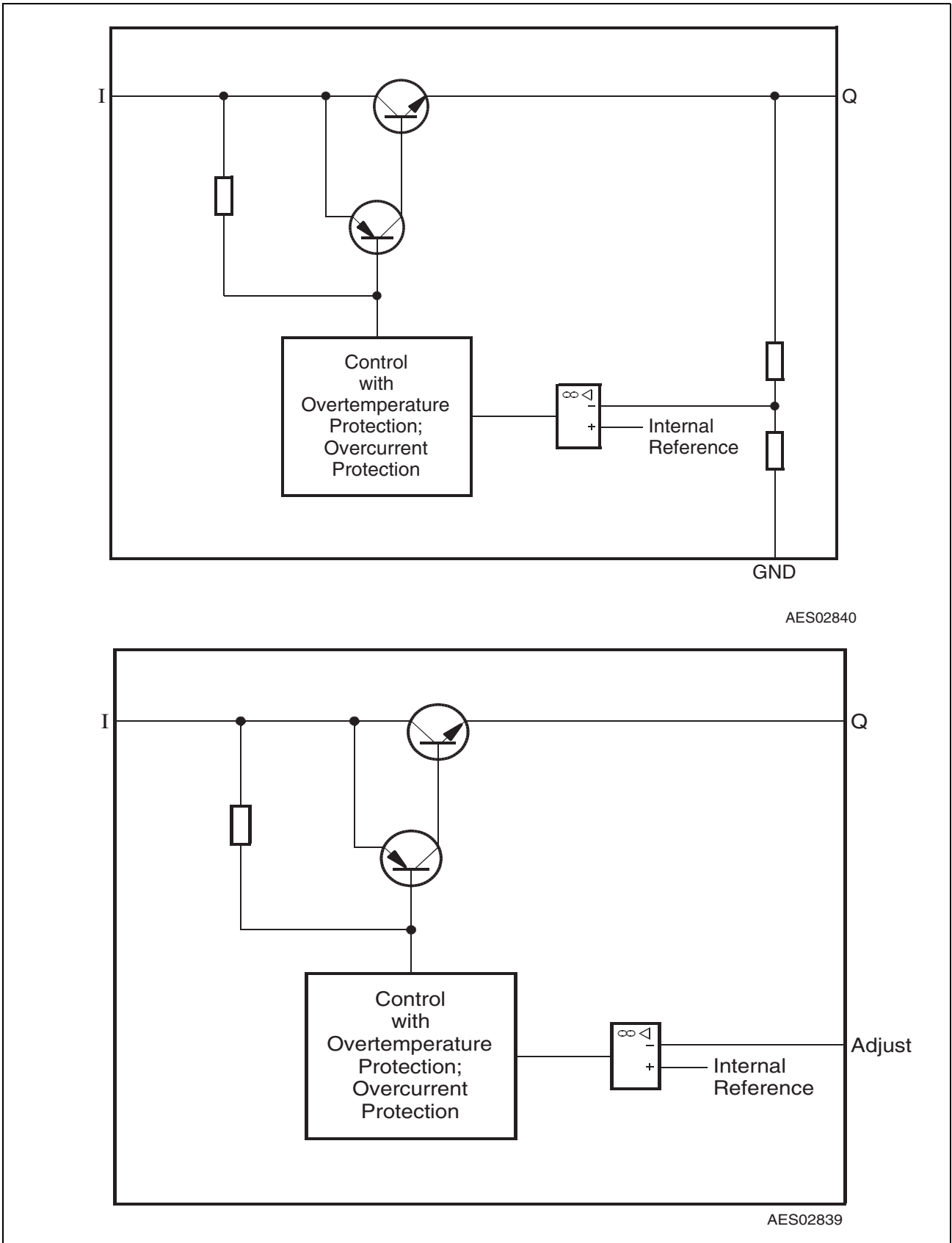

**Figure 1 Block Diagram for Fixed and Adjustable Output Voltage TLE 4284**

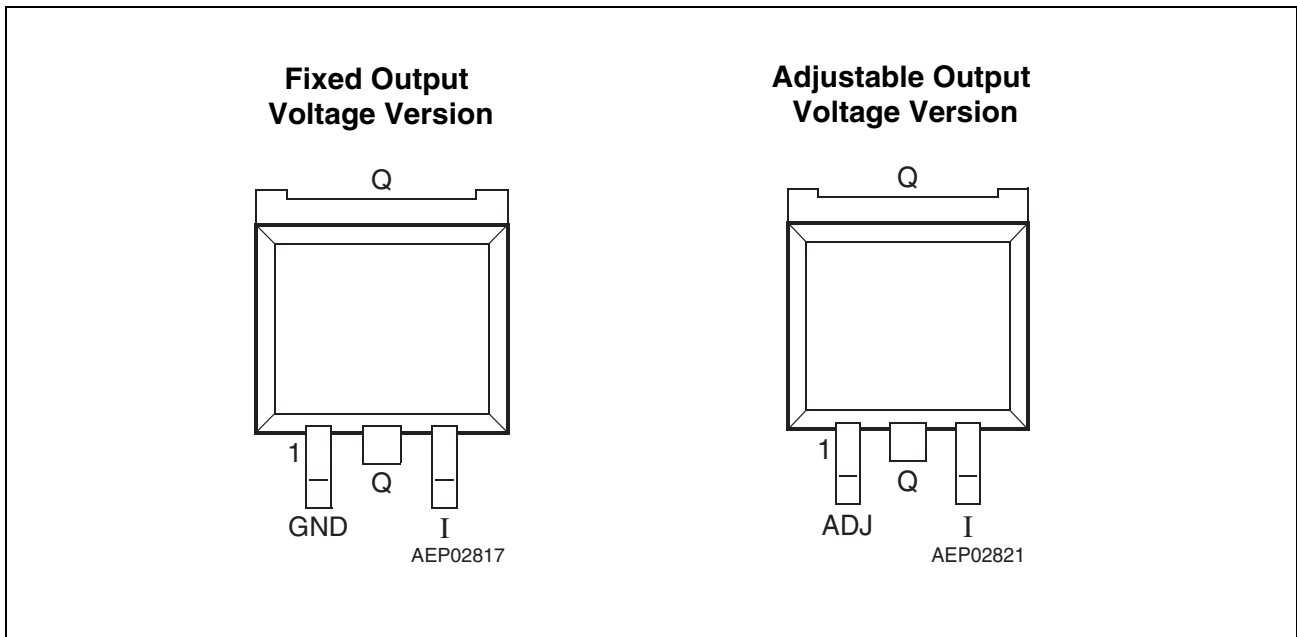

**Figure 2 Pin Configuration (top view)**

**Table 1 Pin Definitions and Functions Fixed Output Voltage Versions**

Pin No.	Symbol	Function
1	GND	<b>Ground</b>
2, Tab	Q	<b>Output;</b> Connect output pin to GND via a capacitor $C_Q \geq 10 \mu\text{F}$ with $\text{ESR} \leq 10 \Omega$ . Connect to heatsink area.
3	I	<b>Input</b>

**Table 2 Pin Definitions and Functions Adjustable Output Version**

Pin No.	Symbol	Function
1	ADJ	<b>Adjust;</b> defines output voltage by external voltage divider between Q, ADJ and GND.
2, Tab	Q	<b>Output;</b> the output voltage is defined by the external voltage divider between Q, Adjust and Ground. Connect the output pin to GND via a capacitor $C_Q \geq 10 \mu\text{F}$ with $\text{ESR} \leq 10 \Omega$ . Connect to heatsink area.
3	I	<b>Input</b>

**Table 3 Absolute Maximum Ratings**

Parameter	Symbol	Limit Values		Unit	Test Condition
		Min.	Max.		
<b>Input - Output Voltage Difference (variable device only)</b>					
Voltage	$V_I - V_Q$	-0.3	40	V	–
<b>Input Voltage</b>					
Voltage	$V_I$	-0.3	40	V	–
<b>Output (fixed voltage version only)</b>					
Voltage	$V_Q$	-0.3	40	V	–
Current	$I_Q$	–	–	–	Internally limited
<b>Adjust (variable version only)</b>					
Voltage	$V_{ADJ}$	-0.3	40	V	–
Current	$I_{ADJ}$	–	–	–	Internally limited
<b>ESD Susceptibility</b>					
Human Body Model (HBM) <sup>1)</sup>	Class	–	3	–	–
	Voltage	–	4	kV	–
Charged Device Model (CDM) <sup>2)</sup>	Class	–	F5	–	–
	Voltage	–	1	kV	–
<b>Temperature</b>					
Storage temperature	$T_{stg}$	-50	150	°C	–
Junction temperature	$T_j$	-40	150	°C	–

1) ESD HBM test according to JEDEC JESD22-A114

2) ESD CDM test according to JEDEC JESD22-C101

*Note: Stresses above those listed here may cause permanent damage to the device. Exposure to absolute maximum rating conditions for extended periods may affect device reliability.*

**Table 4 Operating Range**

Parameter	Symbol	Limit Values		Unit	Remarks
		Min.	Max.		
Input voltage	$V_I$	$V_{Qnom} + V_{DR}$	40	V	–
Junction temperature	$T_j$	-40	150	°C	–

**Thermal Resistance**

Junction ambient	$R_{thja}$	–	144	K/W	PG-TO252-3-11 footprint only <sup>1)</sup>
		–	78	K/W	PG-TO252-3-11 300 mm <sup>2</sup> heat sink area <sup>1)</sup>
		–	54	K/W	PG-TO252-3-11 600 mm <sup>2</sup> heat sink area <sup>1)</sup>
Junction case	$R_{thjc}$	–	4	K/W	–

1) FR4, 80 x 80 x 1.5mm<sup>2</sup>, 35µm Cu, 5µm Sn, horizontal position, zero airflow

*Note: Within the operating range, the functions given in the circuit description are fulfilled.*

*The values listed in the “Electrical Characteristics” tables are ensured over the operating range of the integrated circuit unless otherwise specified. Typical characteristics specify mean values expected over the production spread. If not otherwise specified, typical characteristics apply at  $T_A = 25\text{ °C}$  and the given supply voltage.*

**Table 5 Electrical Characteristics TLE 4284 DV (adjustable output voltage)**
 $-40\text{ °C} < T_j < 150\text{ °C}; V_I - V_Q = 13.5\text{ V}, I_Q = 10\text{ mA};$  unless otherwise specified

Parameter	Symbol	Limit Values			Unit	Measuring Conditions
		min.	typ.	max.		
Reference voltage	$V_{REF}^{1)}$	1.20	1.25	1.30	V	–
Line regulation	$\Delta V_Q$	–	0.5	1.50	% <sup>2)</sup>	$3\text{ V} \leq (V_I - V_Q) \leq 40\text{ V}$
Load regulation	$\Delta V_Q$	–	0.2	0.4	% <sup>2)</sup>	$10\text{ mA} \leq I_Q \leq 800\text{ mA};$ <sup>4)</sup> $V_I = 3.0\text{ V}; V_Q = V_{REF}$
		–	0.25	0.5	% <sup>2)</sup>	$10\text{ mA} \leq I_Q \leq 1.0\text{ A};$ <sup>4)</sup> $V_I = 3.0\text{ V}; V_Q = V_{REF}$
Dropout voltage	$V_{DR}$	–	1.00	1.20	V	$I_Q = 100\text{ mA}$ <sup>3)</sup>
		–	1.05	1.30	V	$I_Q = 500\text{ mA}$ <sup>3)</sup>
		–	1.10	1.35	V	$I_Q = 800\text{ mA}$ <sup>3)</sup>
		–	1.30	1.40	V	$I_Q = 1.0\text{ A}$ <sup>3)</sup>
Current consumption $I_q = I_I - I_Q$	$I_q$	–	100	120	$\mu\text{A}$	$I_Q = 10\text{ mA};$
Adjust current	$I_{ADJ}$	–	75	120	$\mu\text{A}$	$I_Q = 10\text{ mA}$
Adjust current change	$\Delta I_{ADJ}$	–	2	5	$\mu\text{A}$	$I_Q = 10\text{ mA}$ $3\text{ V} \leq (V_I - V_Q) \leq 40\text{ V}$ <sup>4)</sup>
		–	2	5	$\mu\text{A}$	$10\text{ mA} \leq I_Q \leq 200\text{ mA};$ $V_I - V_Q = 3\text{ V}$ <sup>4)</sup>
Temperature stability	–	–	0.6	–	%	<sup>5)</sup>
Minimum load current <sup>6)</sup>	$I_Q$	–	1	5	mA	$V_I < 40\text{ V};$ $V_Q = V_{REF}$
Current limit	$I_{Qmax}$	1000	–	2200	mA	$1.4\text{V} < V_I - V_Q < 18\text{V};$ $V_Q = V_{nom} - 100\text{ mV}$
		50	200	–	mA	$V_I = 40\text{ V};$ $V_Q = V_{nom} - 100\text{ mV}$ $T_j = 25\text{ °C}$
RMS Output Noise	–	–	30	–	ppm	ppm of $V_Q$ ; $T_j = 25\text{ °C};$ $10\text{ Hz} \leq f \leq 10\text{kHz}$ <sup>5)</sup>

**Table 5 Electrical Characteristics TLE 4284 DV (adjustable output voltage)**
 $-40\text{ }^{\circ}\text{C} < T_j < 150\text{ }^{\circ}\text{C}; V_I - V_Q = 13.5\text{ V}, I_Q = 10\text{ mA};$  unless otherwise specified

Parameter	Symbol	Limit Values			Unit	Measuring Conditions
		min.	typ.	max.		
Power Supply Ripple Rejection	$PSRR$	–	65	–	dB	$V_Q = 10\text{ V}, f_r = 120\text{ Hz}, V_r = 0.5 V_{PP}, C_{ADJ} = 0\text{ }\mu\text{F}^{5)}$
		–	65	–	dB	$V_Q = 10\text{ V}, f_r = 120\text{ Hz}, V_r = 0.5 V_{PP}, C_{ADJ} = 10\text{ }\mu\text{F}^{5)}$

 1)  $V_{REF} = V_Q - V_{ADJ}$ 

 2) Related to  $V_Q$ , measured at constant junction Temperature

 3) Dropout voltage measured when the output voltage has dropped 100 mV from the nominal value obtained at  $V_Q = V_{REF}$ .

4) Constant Junction Temperature

5) Not subject to production test - specified by design.

6) Minimum Output Current to maintain regulation

**Table 6 Electrical Characteristics TLE 4284 DV15 (1.5 V fixed output voltage)**
 $-40\text{ }^{\circ}\text{C} < T_j < 150\text{ }^{\circ}\text{C}; V_I = 13.5\text{ V}, I_Q = 10\text{ mA};$  unless otherwise specified

Parameter	Symbol	Limit Values			Unit	Measuring Conditions
		min.	typ.	max.		
Output voltage	$V_Q$	1.45	1.5	1.55	V	$10\text{ mA} \leq I_Q \leq 1000\text{ mA}; 2.9\text{ V} \leq V_I \leq 16\text{ V}$
		–	1.5	–	V	$10\text{ mA} \leq I_Q \leq 1000\text{ mA}; 16\text{ V} \leq V_I \leq 40\text{ V}^{1)}$
Line regulation	$\Delta V_Q$	–	4.8	22.5	mV	$2.9\text{ V} \leq V_I \leq 40\text{ V}$
Load regulation	$\Delta V_Q$	–	2.6	5.2	mV	$10\text{ mA} \leq I_Q \leq 800\text{ mA};^{2)}$ $V_I = V_{Qnom} + V_{DR}$
		–	3.1	6.25	mV	$10\text{ mA} \leq I_Q \leq 1.0\text{ A}^{2)}$ $V_I = V_{Qnom} + V_{DR}$
Dropout voltage	$V_{DR}$	–	1.00	1.20	V	$I_Q = 100\text{ mA}^{3)}$
		–	1.05	1.30	V	$I_Q = 500\text{ mA}^{3)}$
		–	1.10	1.35	V	$I_Q = 800\text{ mA}^{3)}$
		–	1.30	1.40	V	$I_Q = 1.0\text{ A}^{3)}$
Current consumption $I_q = I_I - I_Q$	$I_q$	–	0.8	1.6	mA	$I_Q = 10\text{ mA}$
Temperature stability	–	–	8.8	–	mV	<sup>4)</sup>

**Table 6 Electrical Characteristics TLE 4284 DV15 (1.5 V fixed output voltage)**  
 $-40\text{ °C} < T_j < 150\text{ °C}$ ;  $V_I = 13.5\text{ V}$ ,  $I_Q = 10\text{ mA}$ ; unless otherwise specified

Parameter	Symbol	Limit Values			Unit	Measuring Conditions
		min.	typ.	max.		
Current limit	$I_{Qmax}$	1000	–	2200	mA	$V_I - V_Q < 18\text{V}$ ; $V_Q = V_{nom} - 100\text{ mV}$
		50	200	–	mA	$V_I = 40\text{ V}$ ; $V_Q = V_{nom} - 100\text{ mV}$ $T_j = 25\text{ °C}$
RMS Output Noise	–	–	30	–	ppm	ppm of $V_Q$ , $T_j = 25\text{ °C}$ $10\text{ Hz} \leq f \leq 10\text{ kHz}$ <sup>4)</sup>
Power Supply Ripple Rejection	$PSRR$	–	65	–	dB	$f_r = 120\text{ Hz}$ , $V_r = 0.5 V_{PP}$ , $C_{ADJ} = 0\text{ }\mu\text{F}$ <sup>4)</sup>
		–	65	–	dB	$f_r = 120\text{ Hz}$ , $V_r = 0.5 V_{PP}$ , $C_{ADJ} = 10\text{ }\mu\text{F}$ <sup>4)</sup>

- 1) Device is usable within given range without destruction, but the accuracy of the output voltage can only be guaranteed in the range specified in the line above.
- 2) Measured at constant junction temperature
- 3) Dropout voltage measured when the output voltage has dropped 100 mV from the nominal value.
- 4) Not subject to production test - specified by design.

**Table 7 Electrical Characteristics TLE 4284 DV18 (1.8 V fixed output voltage)**  
 $-40\text{ °C} < T_j < 150\text{ °C}$ ;  $V_I = 13.5\text{ V}$ ,  $I_Q = 10\text{ mA}$ ; unless otherwise specified

Parameter	Symbol	Limit Values			Unit	Measuring Conditions
		min.	typ.	max.		
Output voltage	$V_Q$	1.75	1.8	1.85	V	$10\text{ mA} \leq I_Q \leq 1000\text{ mA}$ ; $3.2\text{ V} \leq V_I \leq 16\text{ V}$
		–	1.8	–	V	$10\text{ mA} \leq I_Q \leq 1000\text{ mA}$ ; $16\text{ V} \leq V_I \leq 40\text{ V}$ <sup>1)</sup>
Line regulation	$\Delta V_Q$	–	7.2	27	mV	$3.2\text{ V} \leq V_I \leq 40\text{ V}$
Load regulation	$\Delta V_Q$	–	3.4	7.6	mV	$10\text{ mA} \leq I_Q \leq 800\text{ mA}$ <sup>2)</sup> $V_I = V_{Qnom} + V_{DR}$
		–	4.8	9	mV	$10\text{ mA} \leq I_Q \leq 1.0\text{ A}$ <sup>2)</sup> $V_I = V_{Qnom} + V_{DR}$



**Table 7 Electrical Characteristics TLE 4284 DV18 (1.8 V fixed output voltage)**  
 $-40\text{ °C} < T_j < 150\text{ °C}$ ;  $V_I = 13.5\text{ V}$ ,  $I_Q = 10\text{ mA}$ ; unless otherwise specified

Parameter	Symbol	Limit Values			Unit	Measuring Conditions
		min.	typ.	max.		
Dropout voltage	$V_{DR}$	–	1.00	1.20	V	$I_Q = 100\text{ mA}$ <sup>3)</sup>
		–	1.05	1.30	V	$I_Q = 500\text{ mA}$ <sup>3)</sup>
		–	1.10	1.35	V	$I_Q = 800\text{ mA}$ <sup>3)</sup>
		–	1.30	1.40	V	$I_Q = 1.0\text{ A}$ <sup>3)</sup>
Current consumption $I_q = I_I - I_Q$	$I_q$	–	0.8	1.6	mA	$I_Q = 10\text{ mA}$
Temperature stability	–	–	11	–	mV	<sup>4)</sup>
Current limit	$I_{Qmax}$	1000	–	2200	mA	$V_I - V_Q < 18\text{V}$ ; $V_Q = V_{nom} - 100\text{ mV}$
		50	200	–	mA	$V_I = 40\text{ V}$ ; $V_Q = V_{nom} - 100\text{ mV}$ $T_j = 25\text{ °C}$
RMS Output Noise	–	–	30	–	ppm	ppm of $V_Q$ , $T_j = 25\text{ °C}$ $10\text{ Hz} \leq f \leq 10\text{ kHz}$ <sup>4)</sup>
Power Supply Ripple Rejection	$PSRR$	–	65	–	dB	$f_r = 120\text{ Hz}$ ; $V_r = 0.5 V_{PP}$ $C_{ADJ} = 0\text{ }\mu\text{F}$ <sup>4)</sup>
		–	65	–	dB	$f_r = 120\text{ Hz}$ ; $V_r = 0.5 V_{PP}$ , $C_{ADJ} = 10\text{ }\mu\text{F}$ <sup>4)</sup>

1) Device is usable within given range without destruction, but the accuracy of the output voltage can only be guaranteed in the range specified in the line above.

2) Measured at constant junction temperature

3) Dropout voltage measured when the output voltage has dropped 100 mV from the nominal value.

4) Not subject to production test - specified by design.

**Table 8 Electrical Characteristics TLE 4284 DV26 (2.6 V fixed output voltage)**  
 $-40\text{ °C} < T_j < 150\text{ °C}$ ;  $V_I = 13.5\text{ V}$ ,  $I_Q = 10\text{ mA}$ ; unless otherwise specified

Parameter	Symbol	Limit Values			Unit	Measuring Conditions
		min.	typ.	max.		
Output voltage	$V_Q$	2.52	2.60	2.68	V	$10\text{ mA} \leq I_Q \leq 1000\text{ mA}$ ; $4.0\text{ V} \leq V_I \leq 16\text{ V}$
		–	2.60	–	V	$10\text{ mA} \leq I_Q \leq 1000\text{ mA}$ ; $16\text{ V} \leq V_I \leq 40\text{ V}$ <sup>1)</sup>

**Table 8 Electrical Characteristics TLE 4284 DV26 (2.6 V fixed output voltage)**  
 $-40\text{ °C} < T_j < 150\text{ °C}$ ;  $V_I = 13.5\text{ V}$ ,  $I_Q = 10\text{ mA}$ ; unless otherwise specified

Parameter	Symbol	Limit Values			Unit	Measuring Conditions
		min.	typ.	max.		
Line regulation	$\Delta V_Q$	–	11	40	mV	$4.0\text{ V} \leq V_I \leq 40\text{ V}$
Load regulation	$\Delta V_Q$	–	5	11	mV	$10\text{ mA} \leq I_Q \leq 800\text{ mA}$ ; <sup>2)</sup> $V_I = V_{Qnom} + V_{DR}$
		–	7	13	mV	$10\text{ mA} \leq I_Q \leq 1.0\text{ A}$ <sup>2)</sup> $V_I = V_{Qnom} + V_{DR}$
Dropout voltage	$V_{DR}$	–	1.00	1.20	V	$I_Q = 100\text{ mA}$ <sup>3)</sup>
		–	1.05	1.30	V	$I_Q = 500\text{ mA}$ <sup>3)</sup>
		–	1.10	1.35	V	$I_Q = 800\text{ mA}$ <sup>3)</sup>
		–	1.30	1.40	V	$I_Q = 1.0\text{ A}$ <sup>3)</sup>
Current consumption; $I_q = I_I - I_Q$	$I_q$	–	0.8	1.6	mA	$I_Q = 10\text{ mA}$
Temperature stability	–	–	16	–	mV	<sup>4)</sup>
Current limit	$I_{Qmax}$	1000	–	2200	mA	$V_I - V_Q < 18\text{V}$ ; $V_Q = V_{nom} - 100\text{ mV}$
		50	200	–	mA	$V_I = 40\text{ V}$ ; $V_Q = V_{nom} - 100\text{ mV}$ $T_j = 25\text{ °C}$
RMS Output Noise	–	–	30	–	ppm	ppm of $V_Q$ , $T_j = 25\text{ °C}$ $10\text{ Hz} \leq f \leq 10\text{ kHz}$ <sup>4)</sup>
Power Supply Ripple Rejection	$PSRR$	–	65	–	dB	$f_r = 120\text{ Hz}$ , $V_r = 0.5 V_{PP}$ , $C_{ADJ} = 0\text{ }\mu\text{F}$ <sup>4)</sup>
		–	65	–	dB	$f_r = 120\text{ Hz}$ , $V_r = 0.5 V_{PP}$ , $C_{ADJ} = 10\text{ }\mu\text{F}$ <sup>4)</sup>

1) Device is usable within given range without destruction, but the accuracy of the output voltage can only be guaranteed in the range specified in the line above.

2) Measured at constant junction temperature

3) Dropout voltage measured when the output voltage has dropped 100 mV from the nominal value.

4) Not subject to production test - specified by design.

**Table 9 Electrical Characteristics TLE 4284 DV33 (3.3 V fixed output voltage)**  
 $-40\text{ °C} < T_j < 150\text{ °C}$ ;  $V_I = 13.5\text{ V}$ ,  $I_Q = 10\text{ mA}$ ; unless otherwise specified

Parameter	Symbol	Limit Values			Unit	Measuring Conditions
		Min.	Typ.	Max.		
Output voltage	$V_Q$	3.20	3.3	3.40	V	$10\text{ mA} \leq I_Q \leq 1000\text{ mA}$ ; $4.7\text{ V} \leq V_I \leq 16\text{ V}$
		–	3.3	–	V	$10\text{ mA} \leq I_Q \leq 1000\text{ mA}$ ; $16\text{ V} \leq V_I \leq 40\text{ V}$ <sup>1)</sup>
Line regulation	$\Delta V_Q$	–	15	50	mV	$4.7\text{ V} \leq V_I \leq 40\text{ V}$
Load regulation	$\Delta V_Q$	–	6	13	mV	$10\text{ mA} \leq I_Q \leq 800\text{ mA}$ <sup>2)</sup> $V_I = V_{Qnom} + V_{DR}$
		–	8	16	mV	$10\text{ mA} \leq I_Q \leq 1.0\text{ A}$ <sup>2)</sup> $V_I = V_{Qnom} + V_{DR}$
Dropout voltage	$V_{DR}$	–	1.00	1.20	V	$I_Q = 100\text{ mA}$ <sup>3)</sup>
		–	1.05	1.30	V	$I_Q = 500\text{ mA}$ <sup>3)</sup>
		–	1.10	1.35	V	$I_Q = 800\text{ mA}$ <sup>3)</sup>
		–	1.30	1.40	V	$I_Q = 1.0\text{ A}$ <sup>3)</sup>
Current consumption $I_q = I_I - I_Q$	$I_q$	–	0.8	1.6	mA	$I_Q = 10\text{ mA}$
Temperature stability	–	–	20	–	mV	<sup>4)</sup>
Current limit	$I_{Qmax}$	1000	–	2200	mA	$V_I - V_Q < 18\text{V}$ ; $V_Q = V_{nom} - 100\text{ mV}$
		50	200	–	mA	$V_I = 40\text{ V}$ ; $V_Q = V_{nom} - 100\text{ mV}$ $T_j = 25\text{ °C}$
RMS Output Noise	–	–	30	–	ppm	ppm of $V_Q$ ; $T_j = 25\text{ °C}$ ; $10\text{ Hz} \leq f \leq 10\text{ kHz}$ <sup>4)</sup>
Power Supply Ripple Rejection	$PSRR$	–	65	–	dB	$f_r = 120\text{ Hz}$ ; $V_r = 0.5\text{ Vpp}$ ; $C_{ADJ} = 0\text{ }\mu\text{F}$ <sup>4)</sup>
		–	65	–	dB	$f_r = 120\text{ Hz}$ ; $V_r = 0.5\text{ Vpp}$ ; $C_{ADJ} = 10\text{ }\mu\text{F}$ <sup>4)</sup>

- 1) Device is usable within given range without destruction, but the accuracy of the output voltage can only be guaranteed in the range specified in the line above.
- 2) Measured at constant junction temperature.
- 3) Dropout voltage measured when the output voltage has dropped 100 mV from the nominal value.
- 4) Not subject to production test - specified by design.

**Table 10 Electrical Characteristics TLE 4284 DV50 (5.0 V fixed output voltage)**  
 $-40\text{ °C} < T_j < 150\text{ °C}$ ;  $V_I = 13.5\text{ V}$ ,  $I_Q = 10\text{ mA}$ ; unless otherwise specified

Parameter	Symbol	Limit Values			Unit	Measuring Conditions
		min.	typ.	max.		
Output voltage	$V_Q$	4.85	5.00	5.15	V	$10\text{ mA} \leq I_Q \leq 1000\text{ mA}$ ; $6.4\text{ V} \leq V_I \leq 16\text{ V}$
		–	5.00	–	V	$10\text{ mA} \leq I_Q \leq 1000\text{ mA}$ ; $16\text{ V} \leq V_I \leq 40\text{ V}$ <sup>1)</sup>
Line regulation	$\Delta V_Q$	–	20	75	mV	$6.4\text{ V} \leq V_I \leq 40\text{ V}$
Load regulation	$\Delta V_Q$	–	9	20	mV	$10\text{ mA} \leq I_Q \leq 800\text{ mA}$ <sup>2)</sup> $V_I = V_{Qnom} + V_{DR}$
		–	12	24	mV	$10\text{ mA} \leq I_Q \leq 1.0\text{ A}$ <sup>2)</sup> $V_I = V_{Qnom} + V_{DR}$
Dropout voltage	$V_{DR}$	–	1.00	1.20	V	$I_Q = 100\text{ mA}$ <sup>3)</sup>
		–	1.05	1.30	V	$I_Q = 500\text{ mA}$ <sup>3)</sup>
		–	1.10	1.35	V	$I_Q = 800\text{ mA}$ <sup>3)</sup>
		–	1.30	1.40	V	$I_Q = 1.0\text{ A}$ <sup>3)</sup>
Current consumption $I_q = I_I - I_Q$	$I_q$	–	0.8	1.6	mA	$I_Q = 10\text{ mA}$
Temperature stability	–	–	30	–	mV	<sup>4)</sup>
Current limit	$I_{Qmax}$	1000	–	2200	mA	$V_I - V_Q < 18\text{ V}$ ; $V_Q = V_{nom} - 100\text{ mV}$
		50	200	–	mA	$V_I = 40\text{ V}$ ; $V_Q = V_{nom} - 100\text{ mV}$ $T_j = 25\text{ °C}$
RMS Output Noise	–	–	30	–	ppm	ppm of $V_Q$ , $T_j = 25\text{ °C}$ $10\text{ Hz} \leq f \leq 10\text{ kHz}$ <sup>4)</sup>
Power Supply Ripple Rejection	$PSRR$	–	65	–	dB	$f_r = 120\text{ Hz}$ , $V_r = 0.5 V_{PP}$ , $C_{ADJ} = 0\text{ }\mu\text{F}$ <sup>4)</sup>
		–	65	–	dB	$f_r = 120\text{ Hz}$ , $V_r = 0.5 V_{PP}$ , $C_{ADJ} = 10\text{ }\mu\text{F}$ <sup>4)</sup>

1) Device is usable within given range without destruction, but the accuracy of the output voltage can only be guaranteed in the range specified in the line above.

2) Measured at constant junction temperature

3) Dropout voltage measured when the output voltage has dropped 100 mV from the nominal value.

4) Not subject to production test - specified by design.

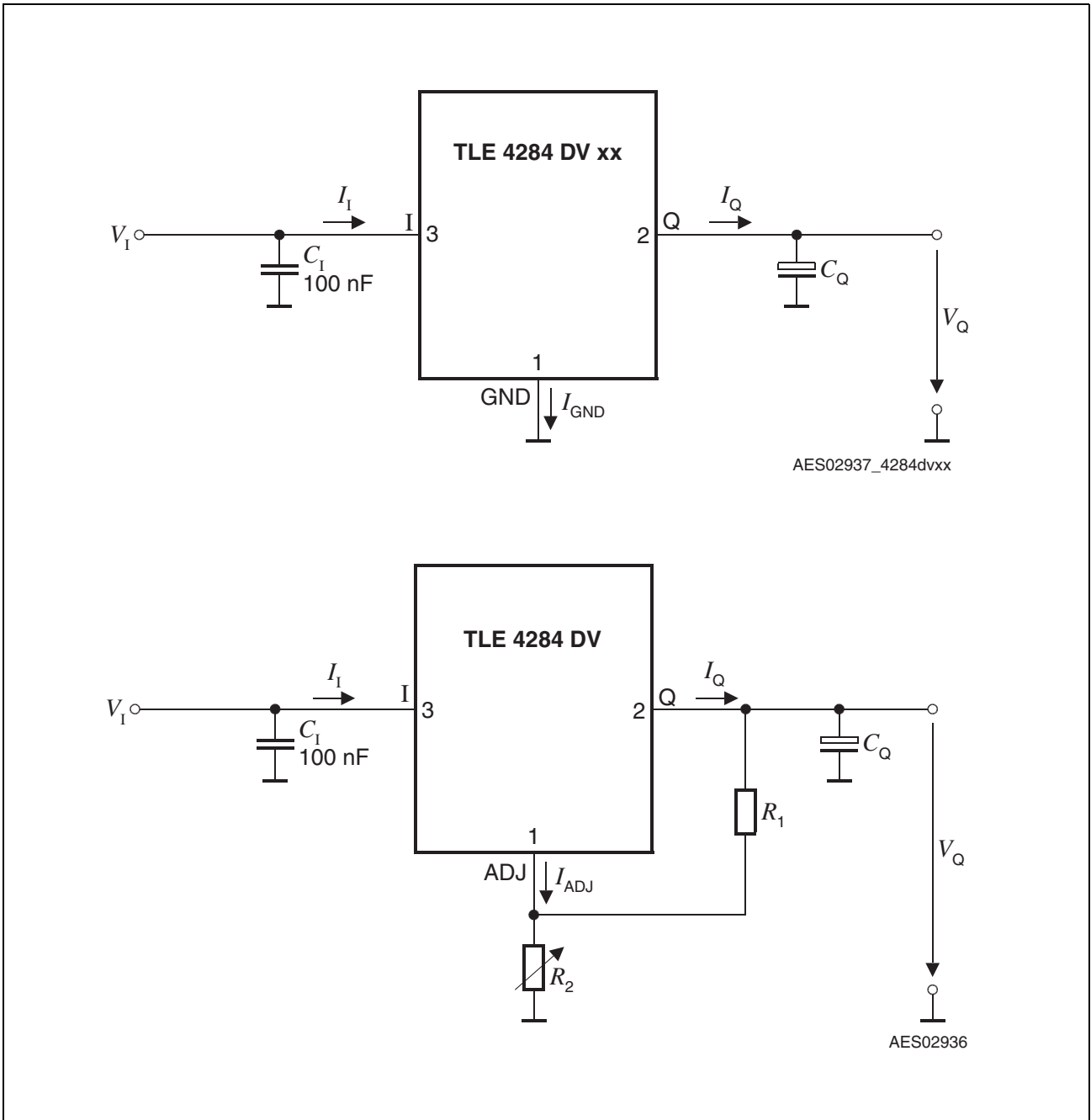

**Figure 3 Measuring Circuit of fixed output voltage versions and adjustable output voltage version**

Application Information

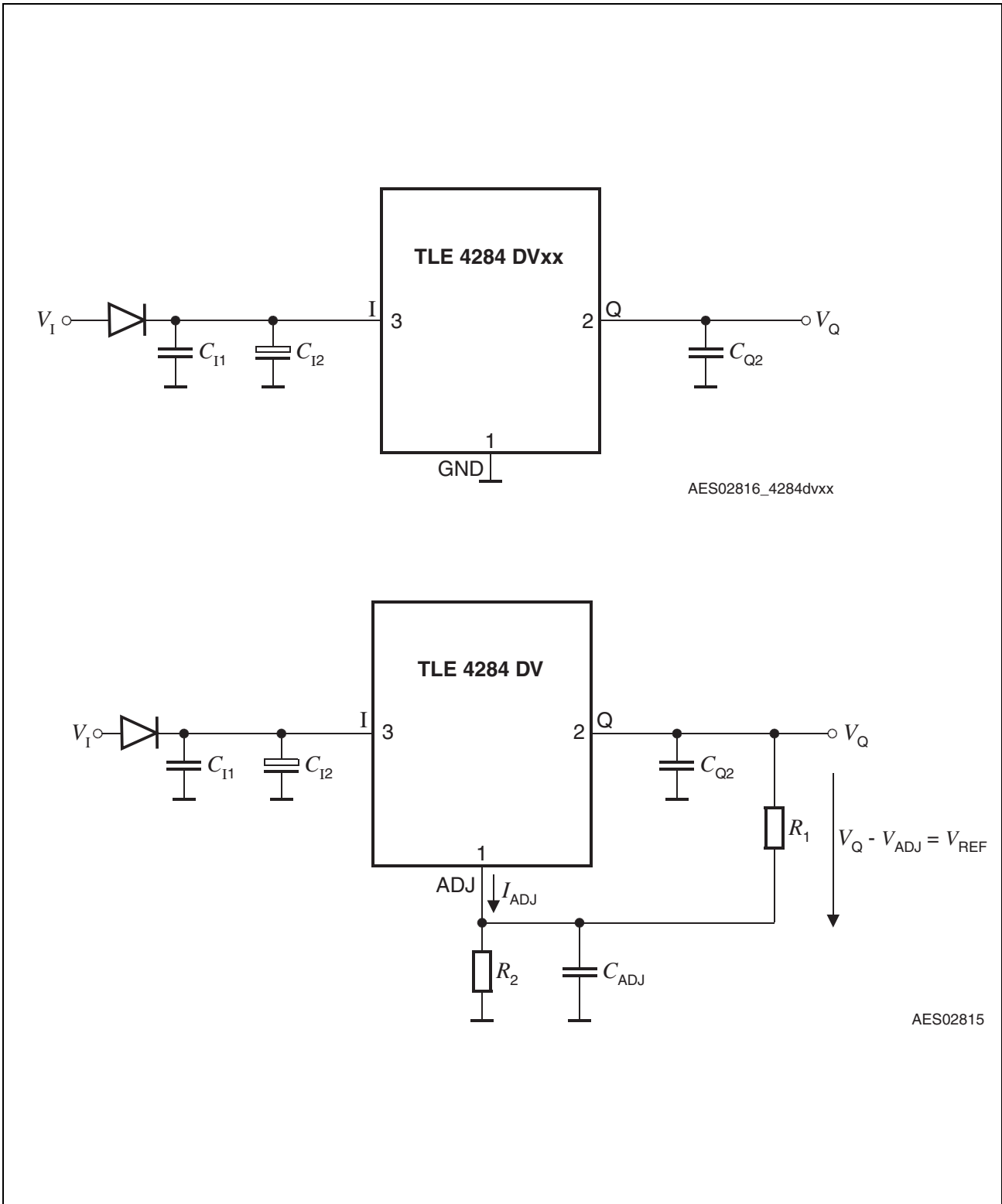
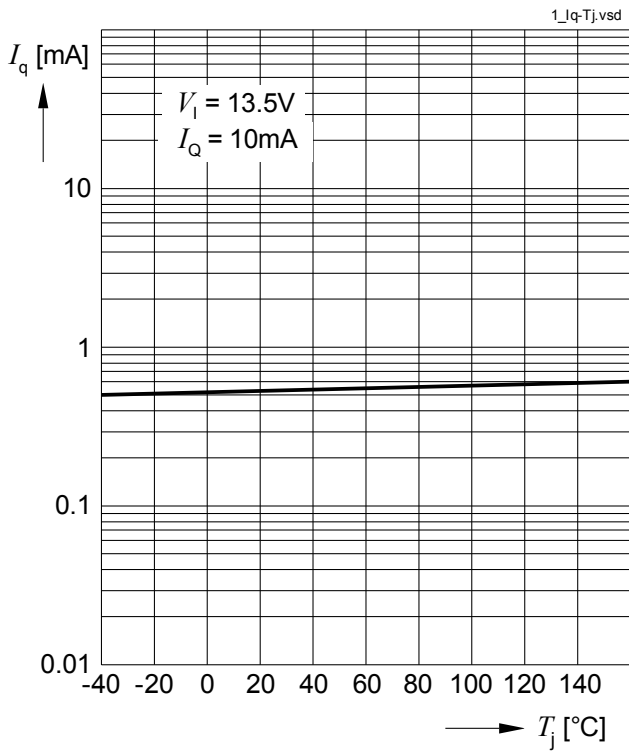

Figure 4 Typical application circuit of fixed output voltage versions and adjustable output voltage version

**Typical Performance Characteristics**

**Current Consumption  $I_q$  versus Junction Temperature  $T_j$**



**Current Consumption  $I_q$  versus Input Voltage  $V_i$**

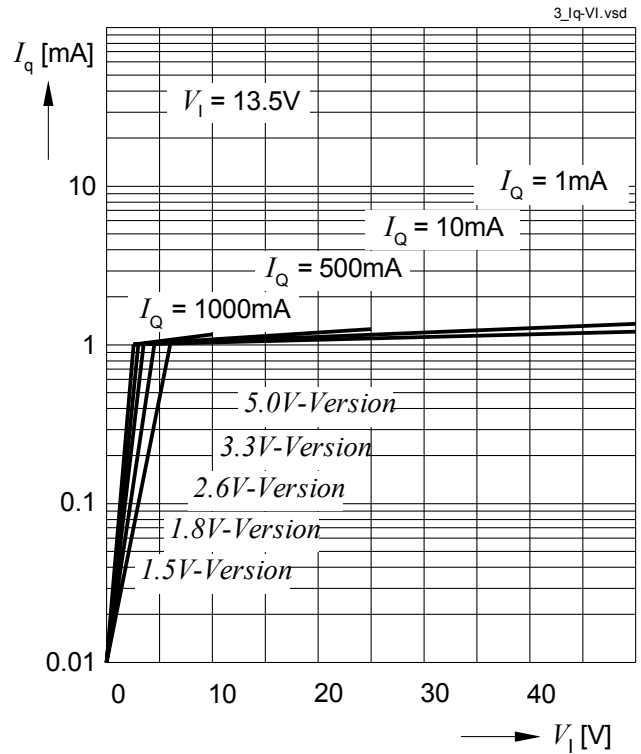

**Current Consumption  $I_q$  versus Output Current  $I_Q$**

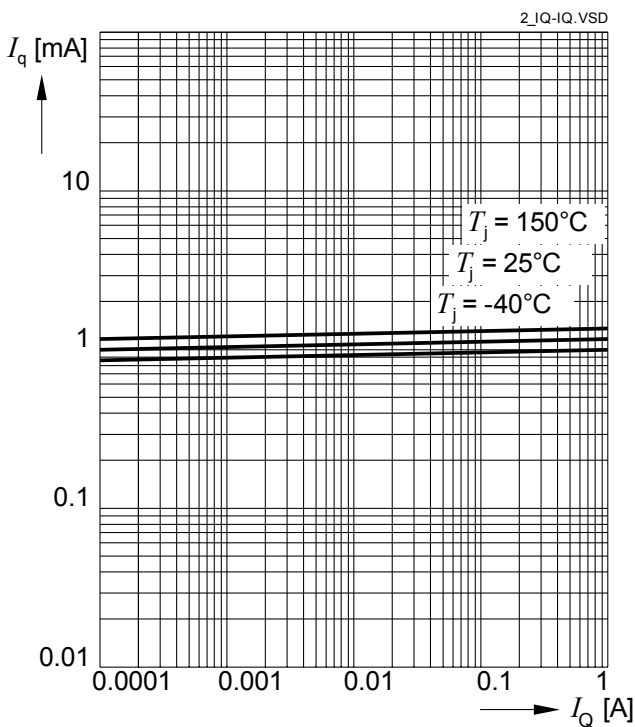

**Adjust Current  $I_{ADJ}$  and Reference Voltage  $V_{Ref}$  vs Junction Temperature  $T_j$**

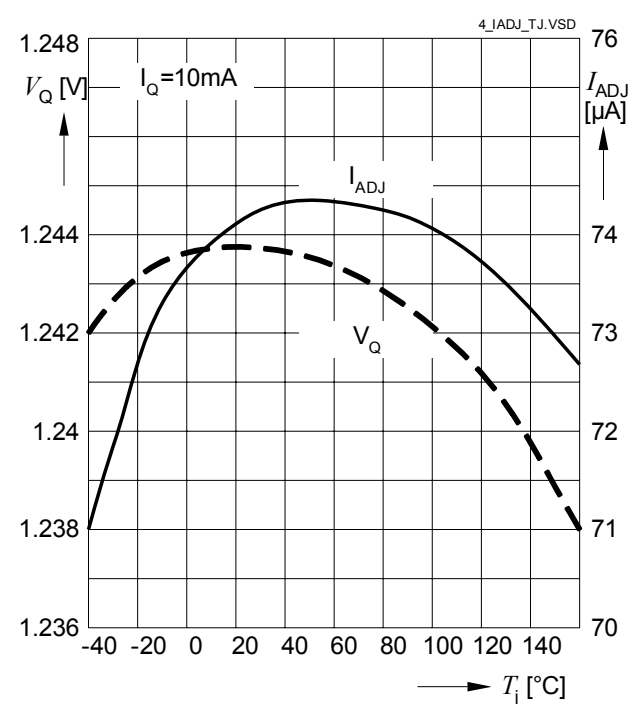





**Output Voltage  $V_Q$  versus Junction Temperature  $T_j$**

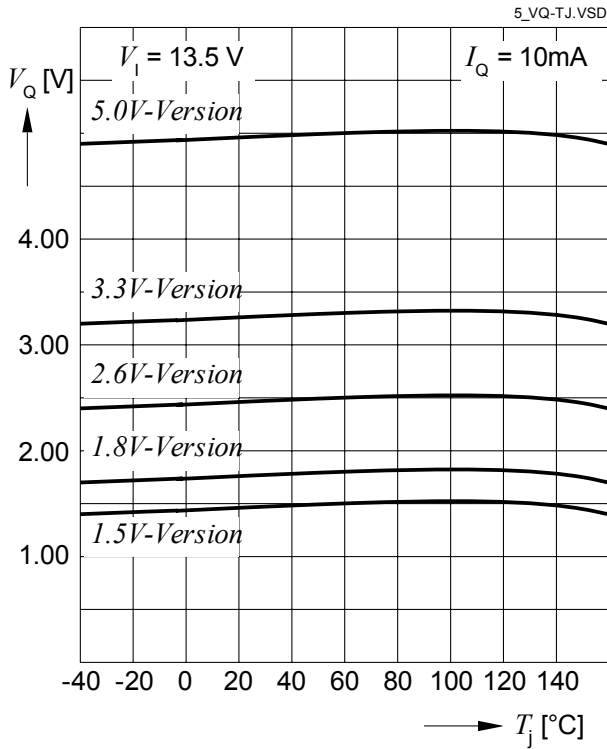

**Output Current Limit  $I_{Qmax}$  versus Junction Temperature  $T_j$**

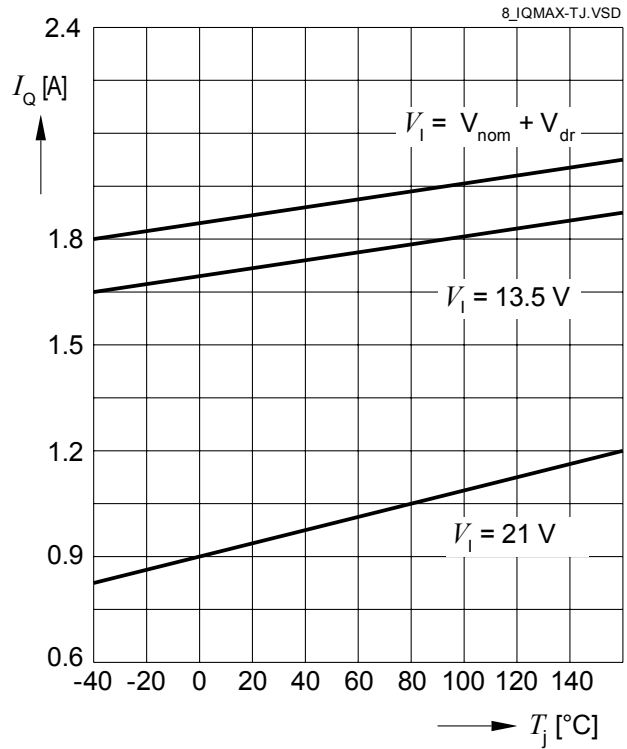

**Dropout Voltage  $V_{DR}$  versus Junction Temperature  $T_j$**

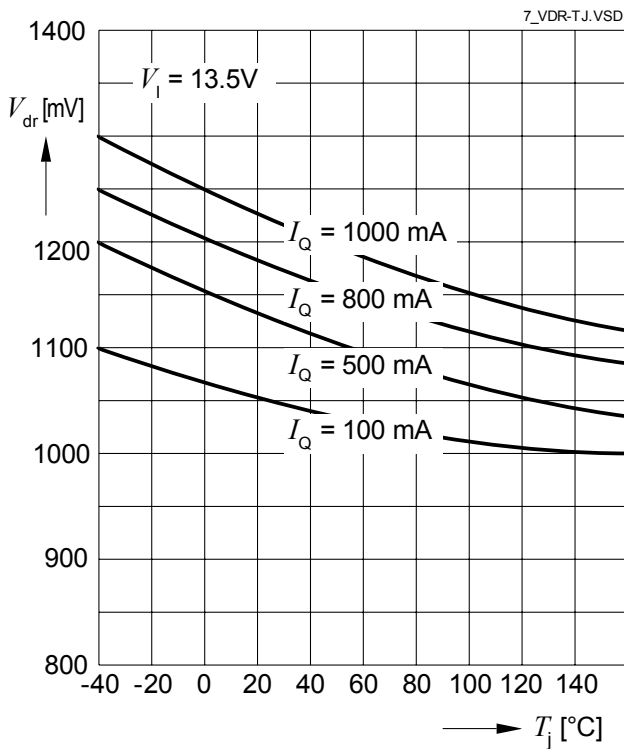

**Safe Operation Area (SOA): Output Current  $I_Q$  vs. Input Voltage  $V_I$**

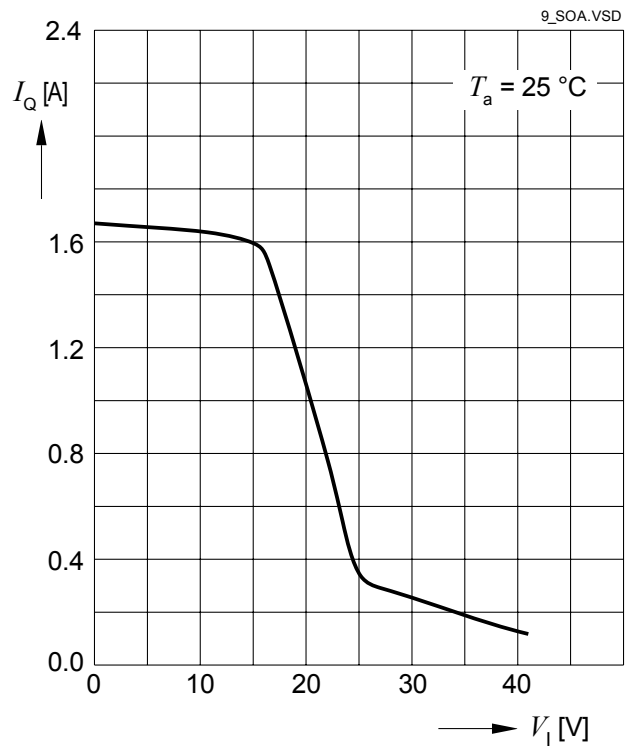

### Output Voltage $V_Q$ versus Input Voltage $V_I$

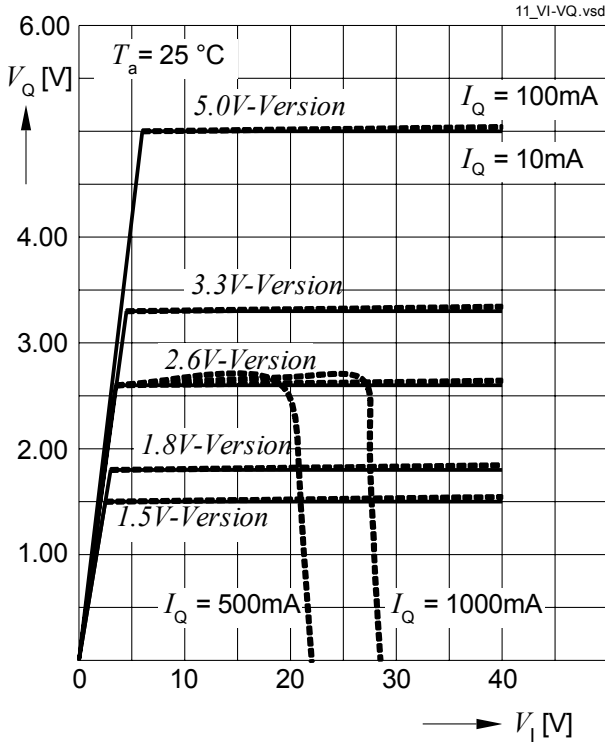

### Power Supply Ripple Rejection versus Frequency

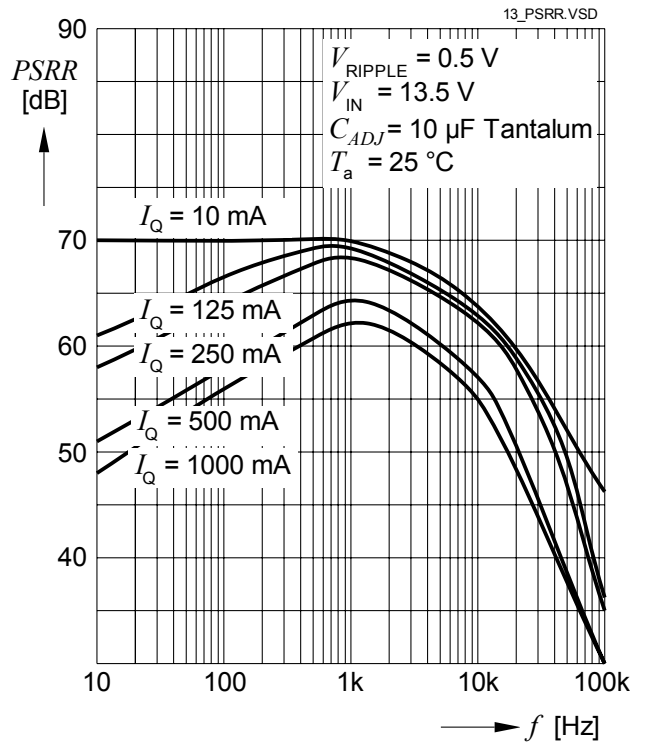

### Stability Region: Equivalent Serial Resistor ESR versus Output Current $I_Q$

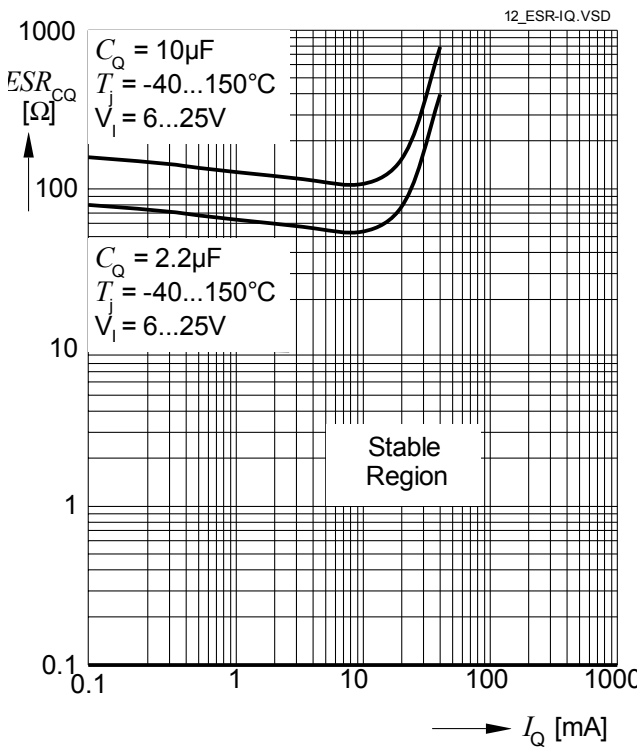

### Power Supply Ripple Rejection versus Frequency

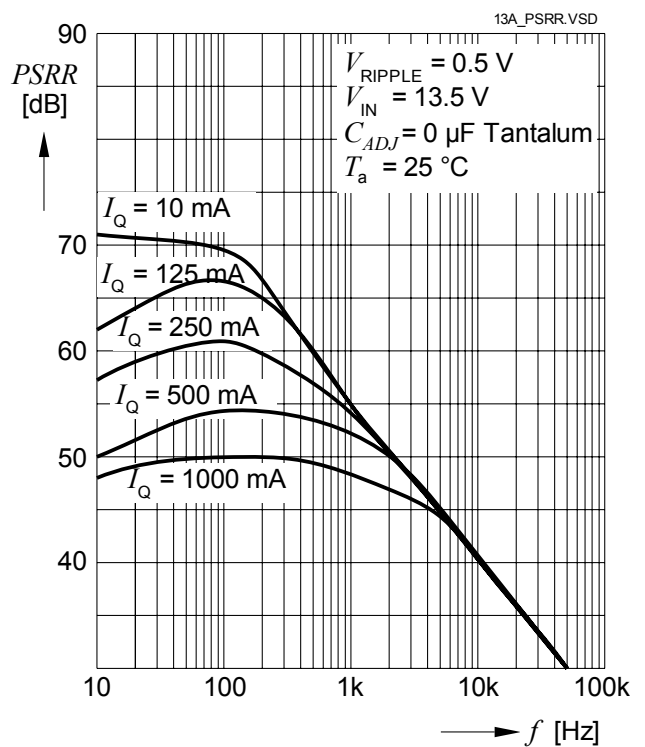

**Load Regulation: Delta Output Voltage  $dV_Q$  versus delta Output Current  $dI_Q$**

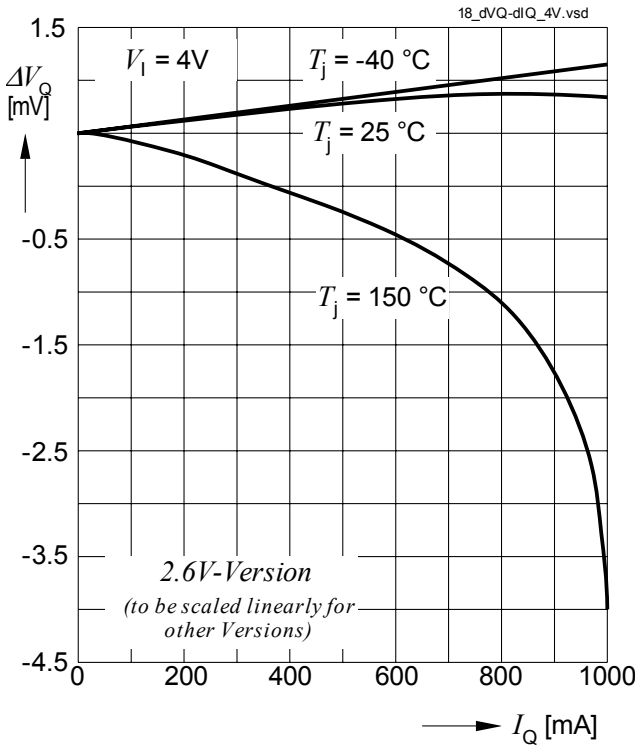

**Load Regulation: Delta Output Voltage  $dV_Q$  versus delta Output Current  $dI_Q$**

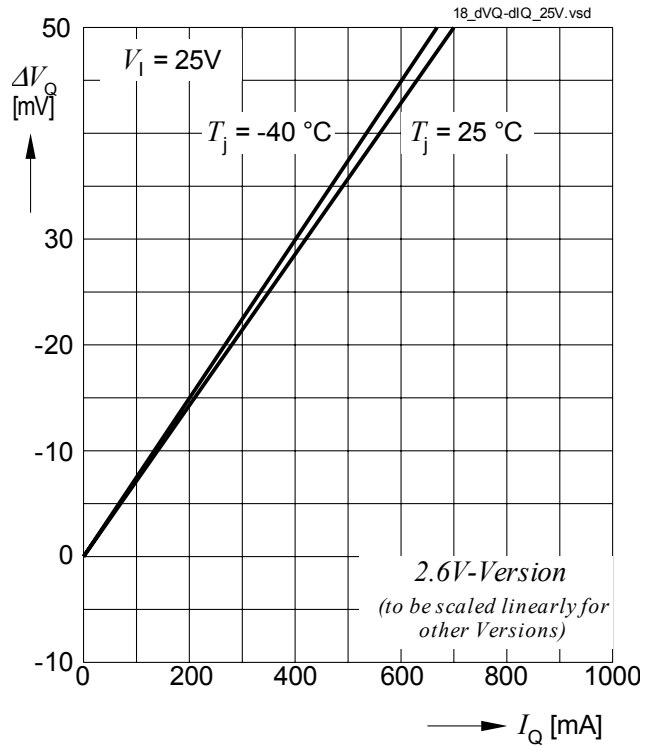

**Load Regulation: Delta Output Voltage  $dV_Q$  versus delta Output Current  $dI_Q$**

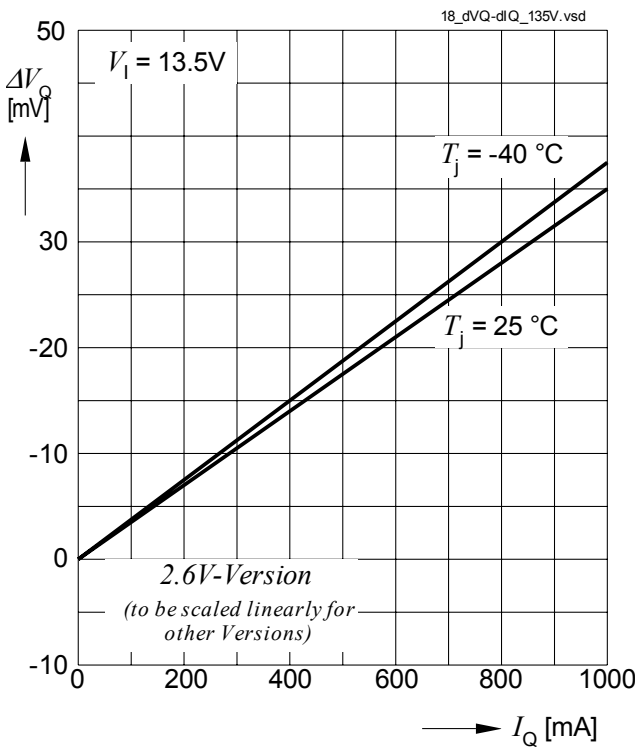

**Line Regulation: Delta Output Voltage  $dV_Q$  versus delta Input Voltage  $dV_I$**

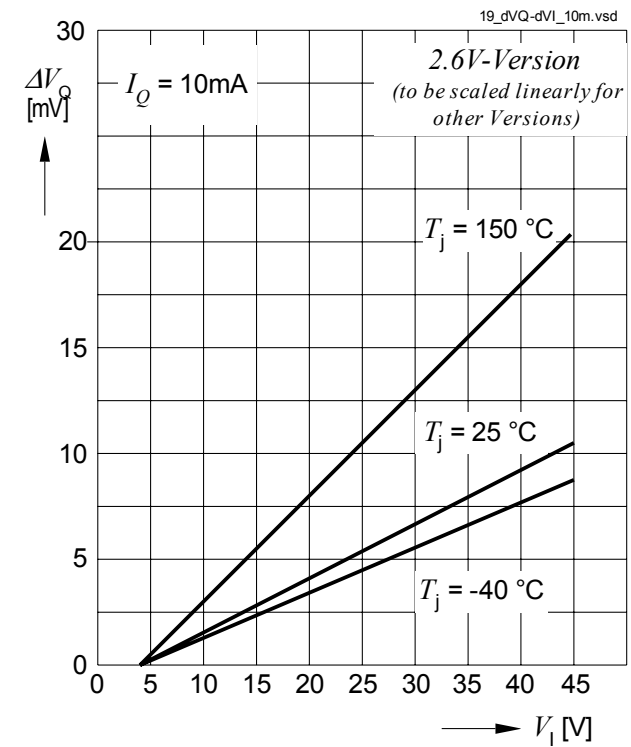

**Line Regulation: Delta Output Voltage  $dV_Q$  versus delta Input Voltage  $dV_I$**

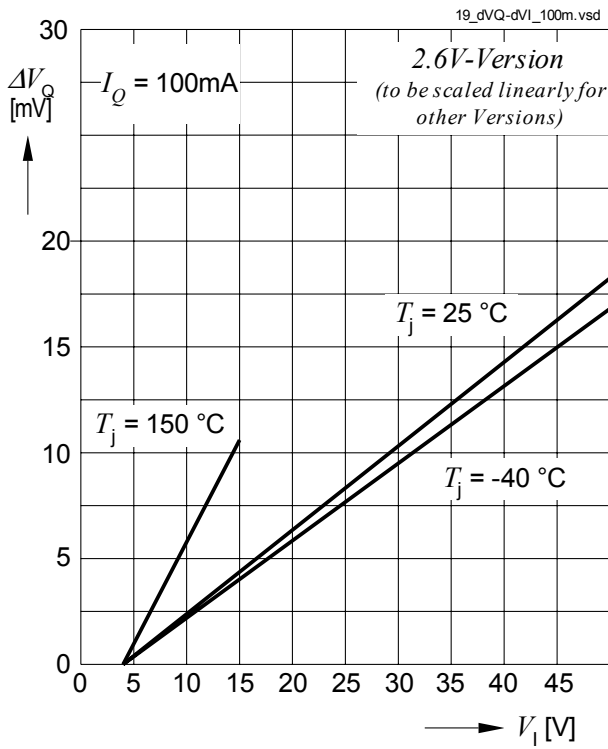

## Application Hints

### Adjustable Version

At the fixed voltage TLE 4284 devices, the output voltage is divided internally and compared to an internal reference of 1.25 V typical. The regulation loop controls the output voltage to achieve the output voltage of 5 V, 3.3 V, 2.6 V, 1.8V or 1.5V. The variable version compares the voltage difference between the adjust pin ADJ and the output pin Q to the internal reference of typically 1.25 V. The output voltage is adjusted by an external voltage divider between Q, ADJ and GND and calculates:

$$V_Q = V_{REF} \times \left( 1 + \frac{R_2}{R_1} \right) + I_{ADJ} \times R_2$$

For the variable regulator TLE 4284 DV, a minimum load current of 5 mA is necessary in order to keep the output voltage regulated. If the application does not assure this minimum load requirement, the output voltage divider should be dimensioned sufficiently low-ohmic:  $R_1 \leq 240 \Omega$ .

For the variable voltage type an additional decoupling a capacitor  $C_{ADJ}$  at the adjust pin improves the ripple rejection ratios. Placing  $C_{ADJ}$  requires an increased output capacitance of  $C_Q \geq 22 \mu\text{F}$ .

### Output

The output current limitation is reduced as a function of the input voltage for high input voltages above 25 V.

The TLE 4284 requires a 10  $\mu\text{F}$  output capacitor with  $0.1 \Omega \leq \text{ESR} \leq 10 \Omega$  for the stability of the regulation loop.

At the input of the regulator a capacitor is necessary for compensation of line influences. A serial diode should be used to eliminate negative voltages from the input. As a minimum, a 100 nF ceramic input capacitor should be used. If the regulator is used in an environment with long input lines, an input capacitance of 10  $\mu\text{F}$  is recommended.

Package Outlines

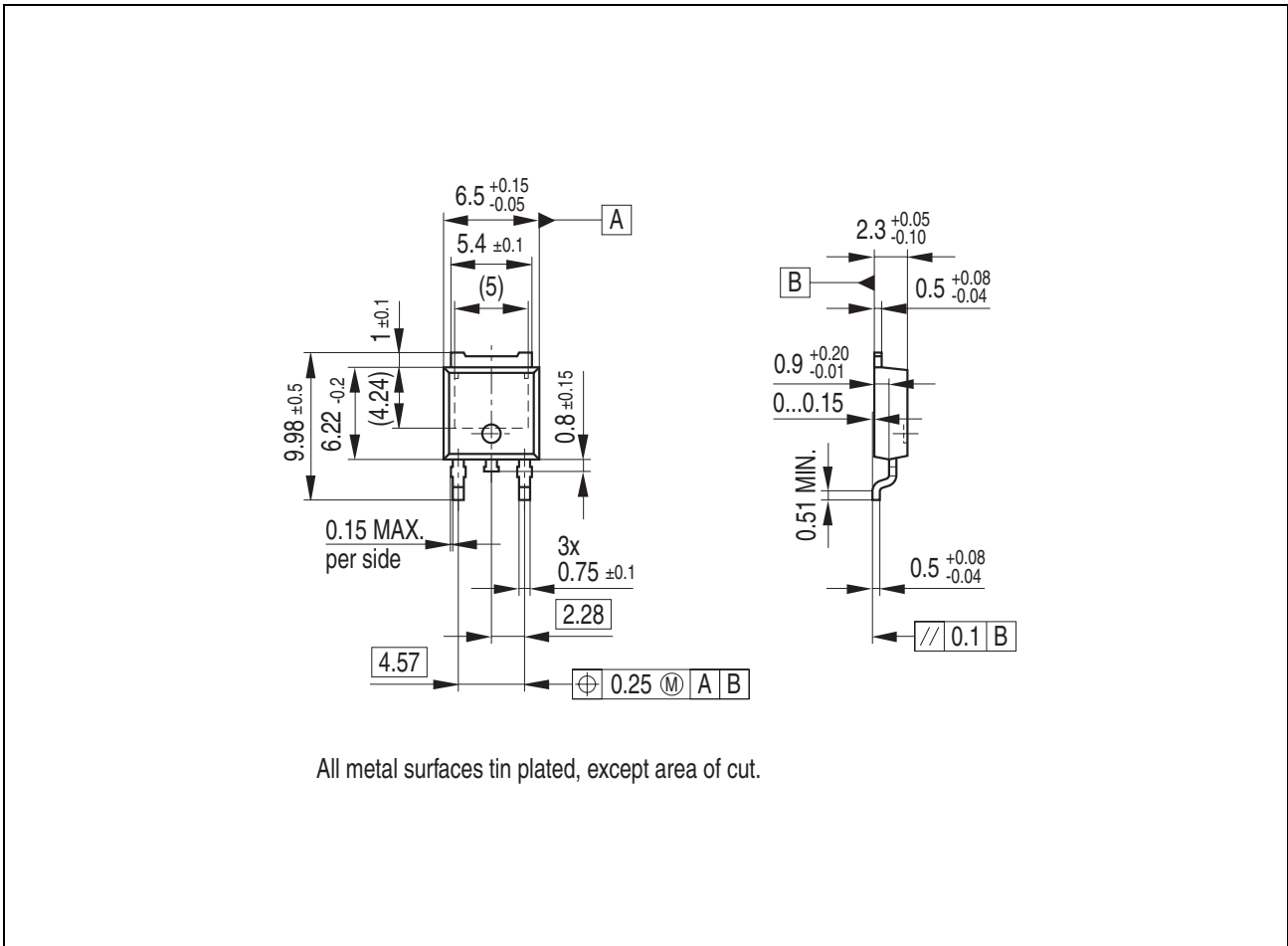

Figure 5 Dimensions PG-T0252-3-11

Green Product (RoHS compliant)

To meet the world-wide customer requirements for environmentally friendly products and to be compliant with government regulations the device is available as a green product. Green products are RoHS-Compliant (i.e Pb-free finish on leads and suitable for Pb-free soldering according to IPC/JEDEC J-STD-020).

Find all packages, sorts of packing and others at the Infineon Internet Page:  
<http://www.infineon.com/packages>.

SMD = Surface Mounted Device

Dimensions in mm

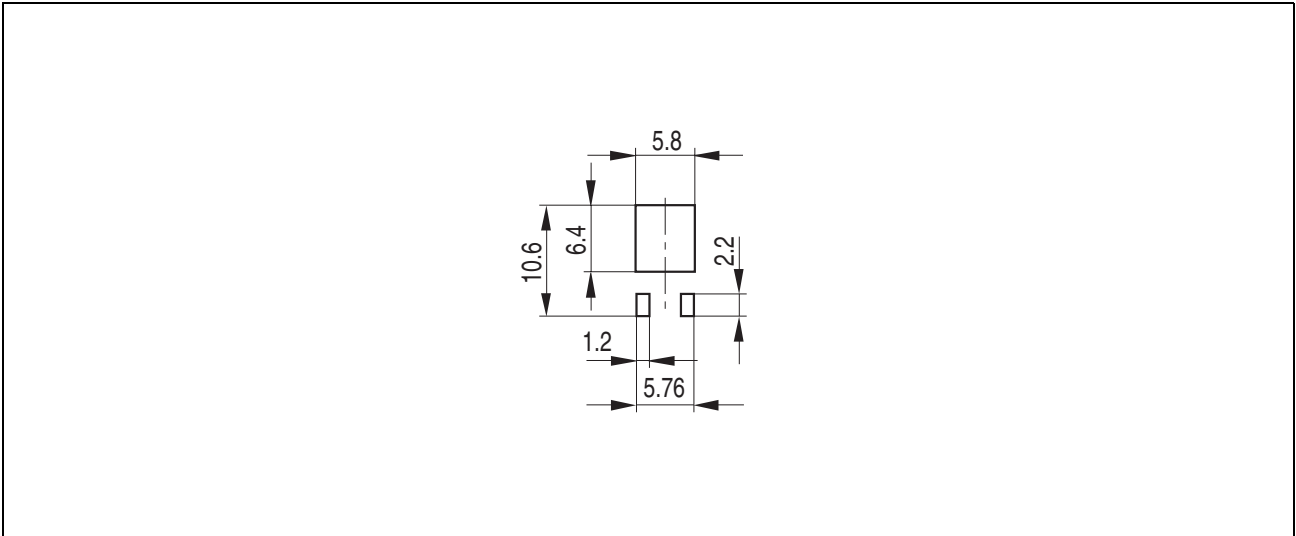

**Figure 6 Footprint for PG-T0252-3-11**

Find all packages, sorts of packing and others at the Infineon Internet Page:  
<http://www.infineon.com/packages>.

SMD = Surface Mounted Device

Dimensions in mm

Revision History

Version	Date	Changes
Rev. 2.0	2006-02-13	<p>Page 1: 1.5 V fixed voltage version changed to final status.</p> <p>Page 1: Ordering Codes updated.</p> <p>Table 1, 2: Low ESR requirement for C<sub>Q</sub> removed.</p> <p>Table 3: Max. Ratings: ESD Susceptibility Human Body Model improved to 4 kV.</p> <p>Several: Typo and formatting corrections.</p>
Rev. 2.1	2007-03-20	<p>Initial version of RoHS-compliant derivate of TLE 4284</p> <p><b>Page 1</b>: AEC certified statement added</p> <p><b>Page 1</b> and <b>Page 22</b>: RoHS compliance statement and Green product feature added</p> <p><b>Page 1</b> and <b>Page 22</b>: Package changed to RoHS compliant version</p> <p>Legal Disclaimer updated</p>



**Edition 2007-03-20**

**Published by  
Infineon Technologies AG  
81726 Munich, Germany**

**© 2007 Infineon Technologies AG  
All Rights Reserved.**

#### **Legal Disclaimer**

The information given in this document shall in no event be regarded as a guarantee of conditions or characteristics. With respect to any examples or hints given herein, any typical values stated herein and/or any information regarding the application of the device, Infineon Technologies hereby disclaims any and all warranties and liabilities of any kind, including without limitation, warranties of non-infringement of intellectual property rights of any third party.

#### **Information**

For further information on technology, delivery terms and conditions and prices, please contact the nearest Infineon Technologies Office ([www.infineon.com](http://www.infineon.com)).

#### **Warnings**

Due to technical requirements, components may contain dangerous substances. For information on the types in question, please contact the nearest Infineon Technologies Office.

Infineon Technologies components may be used in life-support devices or systems only with the express written approval of Infineon Technologies, if a failure of such components can reasonably be expected to cause the failure of that life-support device or system or to affect the safety or effectiveness of that device or system. Life support devices or systems are intended to be implanted in the human body or to support and/or maintain and sustain and/or protect human life. If they fail, it is reasonable to assume that the health of the user or other persons may be endangered.