

FEATURES

- Adjustable Output Voltage
- 1%/2% Accuracy (25°C/Full Range)
- 500-mV (Max) Dropout at Full Load of 500 mA
- Extremely Tight Regulation Over Temperature Range
 - 0.1%/V (Max) Line Regulation
 - 0.7% (Max) Load Regulation
- Ultra-Low Noise Capability (300 nV/ $\sqrt{\text{Hz}}$ Typ)
- Shutdown Current of 3 μA (Max)
- Low Temperature Coefficient
- Current Limiting and Thermal Protection
- Stable With Minimum Load of 1 mA
- Reverse-Battery Protection
- Applications
 - Portable Applications (PDAs, Laptops, Cell Phones)
 - Consumer Electronics
 - Post-Regulation for SMPS
- Available in Convenient SOIC-8 Surface-Mount Package

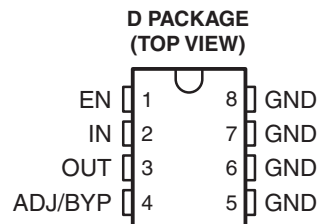

DESCRIPTION/ORDERING INFORMATION

The TL5209 is an efficient PNP low-dropout (LDO) regulator that is well suited for portable applications. It has significantly lower quiescent current than previously was available from traditional PNP regulators and allows for a shutdown current of only 0.05 μA (typical). The TL5209 also has very good dropout voltage characteristics, requiring a maximum dropout of 60 mV at light loads and 500 mV at full load. In addition, the LDO also has 1% output voltage accuracy and extremely tight line and load regulation that is hard to match by its CMOS counterparts.

For noise-sensitive applications, the TL5209 allows for low-noise capability via an external bypass capacitor connected to the BYP pin, which reduces the output noise of the regulator. Other features include current limiting, thermal shutdown, reverse-battery protection, and low temperature coefficient.

The TL5209 is available with adjustable output. Offered in an SOIC-8 surface-mount package, the TL5209 is characterized for operation over the virtual junction temperature ranges of -40°C to 125°C .

ORDERING INFORMATION⁽¹⁾

T _J	PACKAGE ⁽²⁾		ORDERABLE PART NUMBER	TOP-SIDE MARKING
–40°C to 125°C	SOIC – D	Reel of 2000	TL5209DR	TL5209

(1) For the most current package and ordering information, see the Package Option Addendum at the end of this document, or see the TI website at www.ti.com.

(2) Package drawings, standard packing quantities, thermal data, symbolization, and PCB design guidelines are available at www.ti.com/sc/package.



Please be aware that an important notice concerning availability, standard warranty, and use in critical applications of Texas Instruments semiconductor products and disclaimers thereto appears at the end of this data sheet.

BLOCK DIAGRAMS

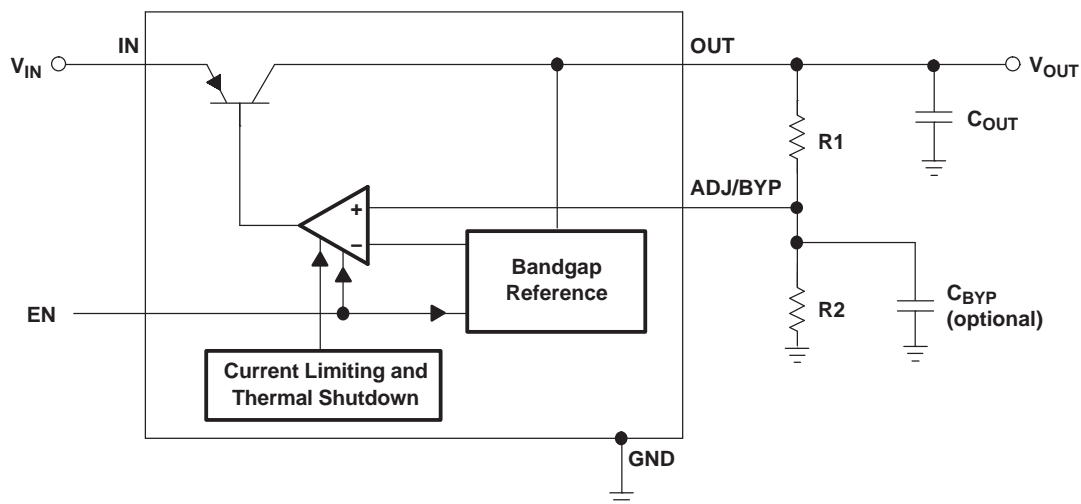

Figure 1. Low-Noise Adjustable Regulator

Absolute Maximum Ratings⁽¹⁾

over operating free-air temperature range (unless otherwise noted)

		MIN	MAX	UNIT
V _I	Continuous input voltage range	–20	20	V
V _O	Output voltage		7.5	V
T _{stg}	Storage temperature range	–65	150	°C

(1) Stresses beyond those listed under *Absolute Maximum Ratings* may cause permanent damage to the device. These are stress ratings only, and functional operation of the device at these or any other conditions beyond those indicated under *Recommended Operating Conditions* is not implied. Exposure to absolute-maximum-rated conditions for extended periods may affect device reliability.

Package Thermal Data⁽¹⁾

PACKAGE	BOARD	θ _{JA}	θ _{JC}
SOIC (D)	High K, JESD 51-7	97°C/W	39°C/W

(1) Maximum power dissipation is a function of T_{J(max)}, θ_{JA}, and T_A. The maximum allowable power dissipation at any allowable ambient temperature is P_D = (T_{J(max)} – T_A)/θ_{JA}. Operating at the absolute maximum T_J of 150°C can affect reliability.

Recommended Operating Conditions

		MIN	MAX	UNIT
V _I	Input voltage	2.5	16	V
V _O	Output voltage		6.5	V
V _{EN}	Enable input voltage	0	V _I	V
T _J	Operating junction temperature range	–40	125	°C

TL5209

500-mA LOW-NOISE LOW-DROPOUT VOLTAGE REGULATOR WITH SHUTDOWN

SLVS581A–SEPTEMBER 2006–REVISED MAY 2007

Electrical Characteristics

$V_{IN} = V_{OUT} + 1\text{ V}$, $C_{OUT} = 4.7\ \mu\text{F}$, $I_{OUT} = 1\text{ mA}$, full range $T_J = -40^\circ\text{C}$ to 125°C

PARAMETER	TEST CONDITIONS	T_J	MIN	TYP	MAX	UNIT
Output voltage accuracy	$V_{OUT} = 2.5\text{ V}$ for ADJ only	25°C	-1		1	%
		Full range	-2		2	
αV_{OUT} Output voltage temperature coefficient		Full range		40		ppm/°C
Line regulation	$V_{IN} = (V_{OUT} + 1\text{ V})$ to 16 V	25°C		0.009	0.05	% / V
		Full range			0.1	
Load regulation	$I_{OUT} = 1\text{ mA}$ to 500 mA ⁽¹⁾	25°C		0.05	0.5	%
		Full range			0.7	
$V_{IN} - V_{OUT}$ Dropout voltage ⁽²⁾	$I_{OUT} = 1\text{ mA}$	25°C		45	60	mV
		Full range			80	
	$I_{OUT} = 50\text{ mA}$	25°C		115	175	
		Full range			250	
	$I_{OUT} = 100\text{ mA}$	25°C		150	250	
		Full range			300	
	$I_{OUT} = 500\text{ mA}$	25°C		350	500	
		Full range			600	
I_Q Quiescent current	$V_{EN} \geq 3\text{ V}$, $I_{OUT} = 1\text{ mA}$	25°C		100	140	μA
		Full range			170	
	$V_{EN} \geq 3\text{ V}$, $I_{OUT} = 50\text{ mA}$	25°C		350	650	
		Full range			900	
	$V_{EN} \geq 3\text{ V}$, $I_{OUT} = 100\text{ mA}$	25°C		1.2	2	mA
		Full range			3	
	$V_{EN} \geq 3\text{ V}$, $I_{OUT} = 500\text{ mA}$	25°C		8	20	
		Full range			25	
I_{min} Minimum load current ⁽³⁾		Full range			1	mA
I_{SD} Shutdown current	$V_{EN} \leq 0.4\text{ V}$	25°C		0.05	3	μA
		Full range			8	
	$V_{EN} \leq 0.18\text{ V}$	25°C		0.1		
Ripple rejection	$f = 120\text{ Hz}$	25°C		75		dB
I_{LIMIT} Current limit	$V_{OUT} = 0\text{ V}$	25°C		700	900	mA
		Full range			1000	
$\Delta V_{OUT}/\Delta P_D$ Thermal regulation ⁽⁴⁾	$V_{IN} = 16\text{ V}$, 500-mA load pulse for $t = 10\text{ ms}$	25°C		0.05		%/W
V_n Output noise	$V_{OUT} = 2.5\text{ V}$, $I_{OUT} = 50\text{ mA}$, $C_{OUT} = 2.2\ \mu\text{F}$, $C_{BYP} = 0$	25°C		500		nV/ $\sqrt{\text{Hz}}$
	$I_{OUT} = 50\text{ mA}$, $C_{OUT} = 2.2\ \mu\text{F}$, $C_{BYP} = 470\text{ pF}$ ⁽⁵⁾	25°C		300		
V_{EN} Enable logic voltage	$V_{EN} = \text{logic LOW (shutdown)}$	25°C			0.4	V
		Full range			0.18	
	$V_{EN} = \text{logic HIGH (enabled)}$	25°C		2		

(1) Low duty cycle testing is used to maintain the junction temperature as close to the ambient temperature as possible. Changes in output voltage due to thermal effects are covered separately by the thermal regulation specification.

(2) Dropout is defined as the input to output differential at which the output drops 2% below its nominal value measured at 1-V differential.

(3) For stability across the input voltage and temperature. For ADJ versions, the minimum current can be set by R1 and R2.

(4) Thermal regulation is defined as the change in output voltage at a specified time after a change in power dissipation is applied, excluding line and load regulation effects.

(5) C_{BYP} is optional and connected to the BYP/ADJ pin.

Electrical Characteristics (continued)
 $V_{IN} = V_{OUT} + 1\text{ V}$, $C_{OUT} = 4.7\ \mu\text{F}$, $I_{OUT} = 1\text{ mA}$, full range $T_J = -40^\circ\text{C}$ to 125°C

PARAMETER	TEST CONDITIONS	T_J	MIN	TYP	MAX	UNIT
I_{EN} Enable input current	$V_{EN} \leq 0.4\text{ V}$ (shutdown)	25°C		0.01	-1	μA
	$V_{EN} \leq 0.18\text{ V}$ (shutdown)	Full range		0.01	-2	
	$V_{EN} \geq 2\text{ V}$ (enabled)	25°C		5	20	
		Full range			25	

TYPICAL CHARACTERISTICS

POWER-SUPPLY REJECTION RATIO

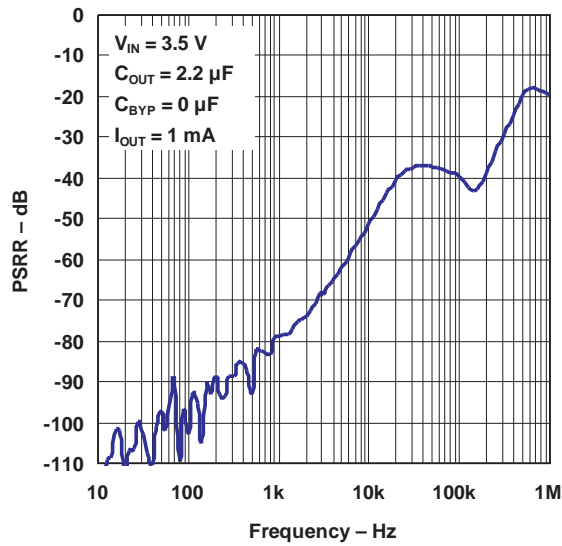

POWER-SUPPLY REJECTION RATIO

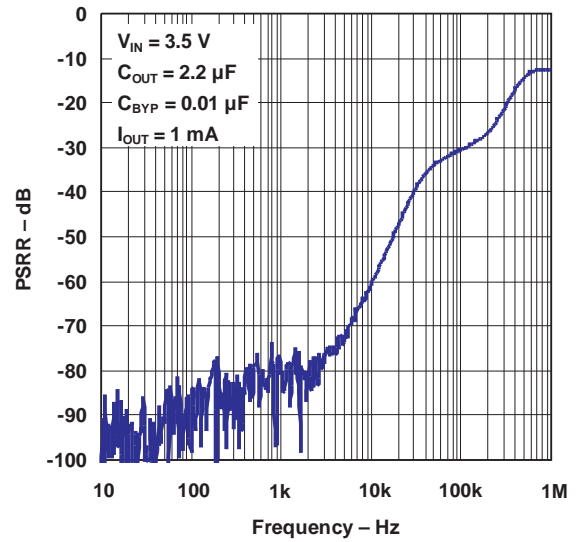

POWER-SUPPLY REJECTION RATIO

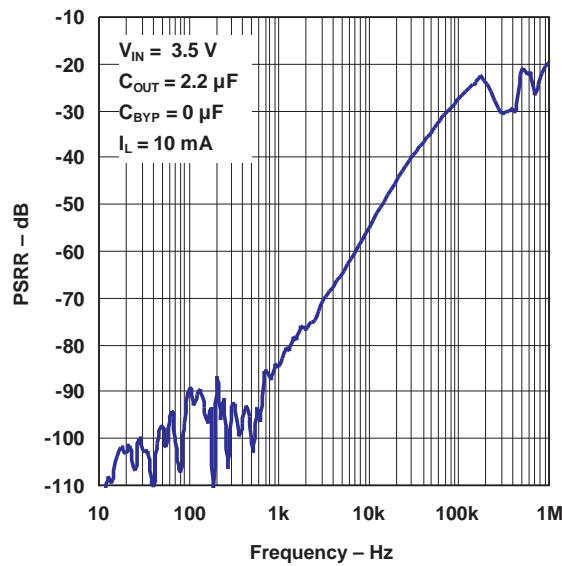

POWER-SUPPLY REJECTION RATIO

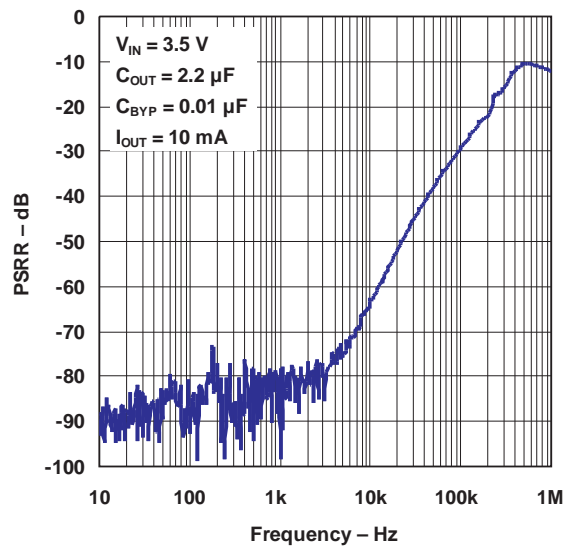

TYPICAL CHARACTERISTICS (continued)

POWER-SUPPLY REJECTION RATIO

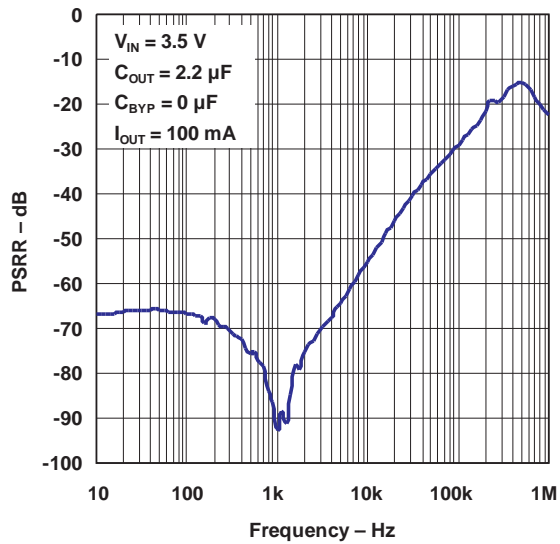

POWER-SUPPLY REJECTION RATIO

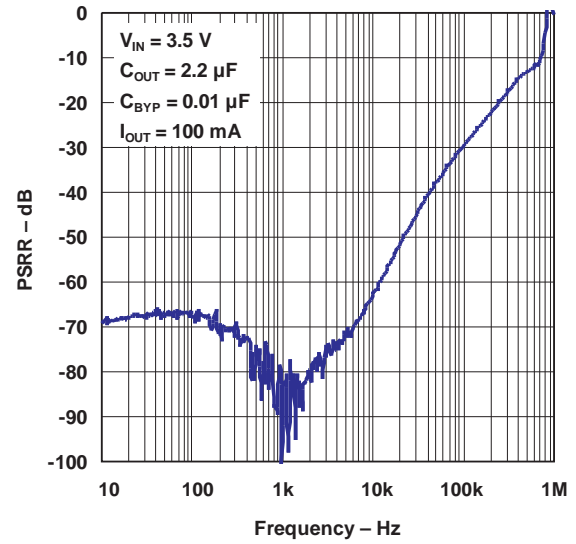

POWER-SUPPLY RIPPLE REJECTION VS VOLTAGE DROP

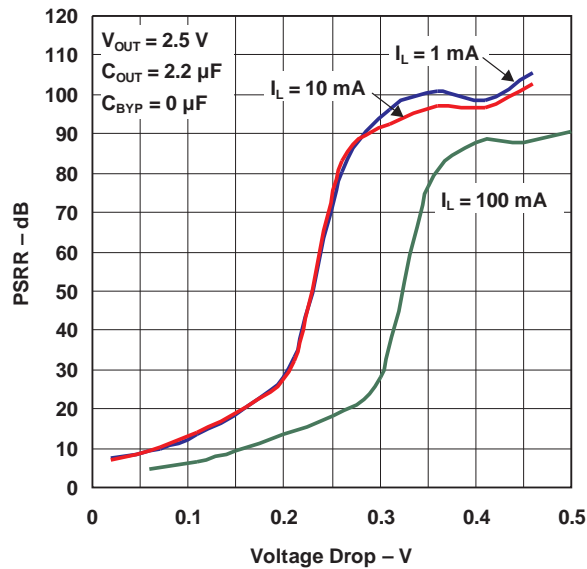

POWER-SUPPLY RIPPLE REJECTION VS VOLTAGE DROP

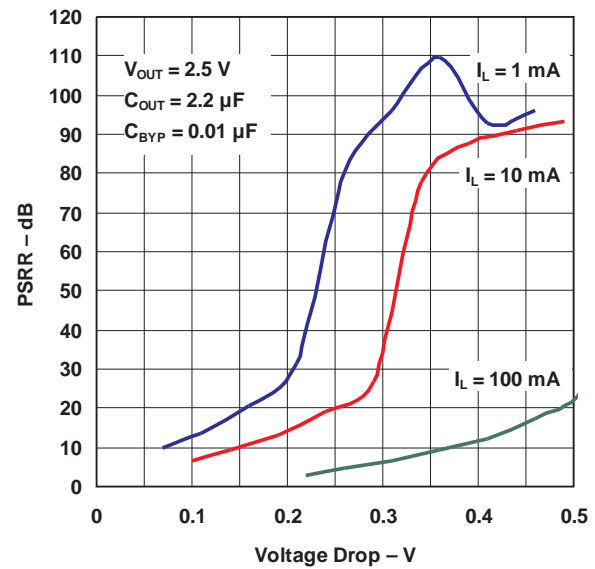

TYPICAL CHARACTERISTICS (continued)

NOISE PERFORMANCE

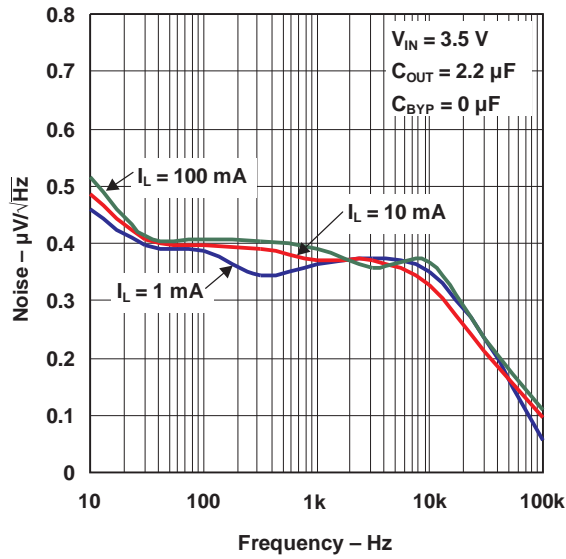

NOISE PERFORMANCE

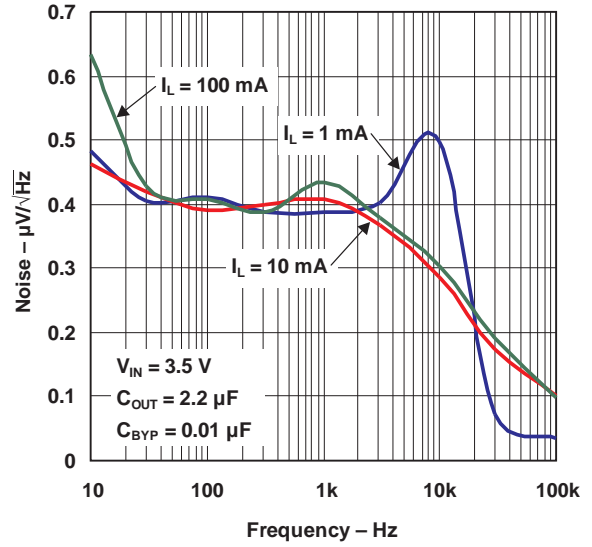

DROPOUT VOLTAGE
 vs
 LOAD CURRENT

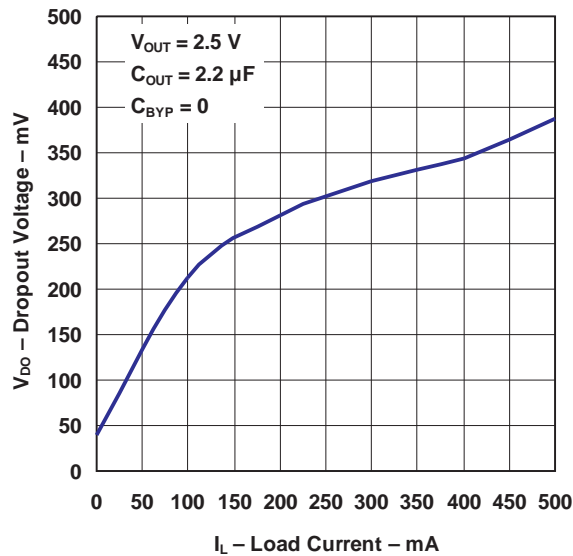

OUTPUT VOLTAGE
 vs
 TEMPERATURE

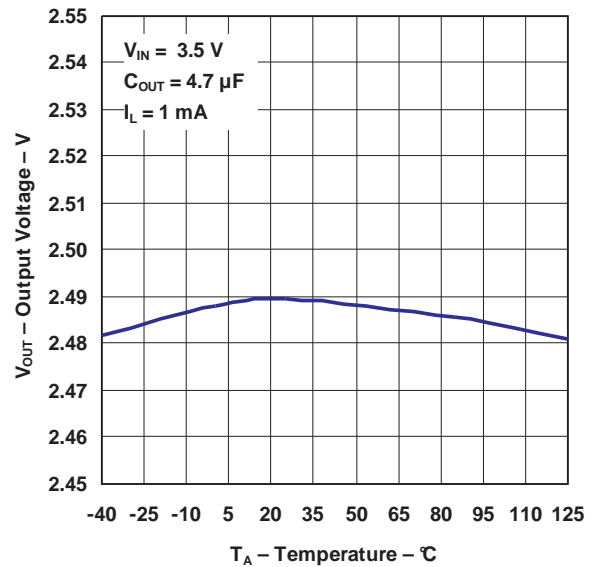

TYPICAL CHARACTERISTICS (continued)

**GROUND CURRENT
vs
LOAD CURRENT**

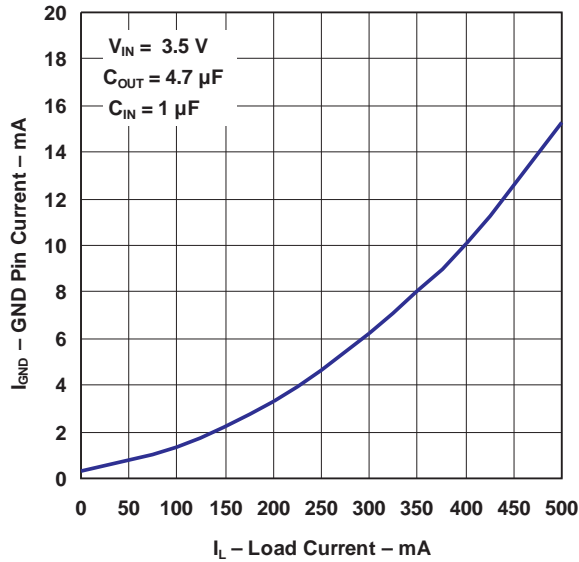

**GROUND CURRENT
vs
SUPPLY VOLTAGE**

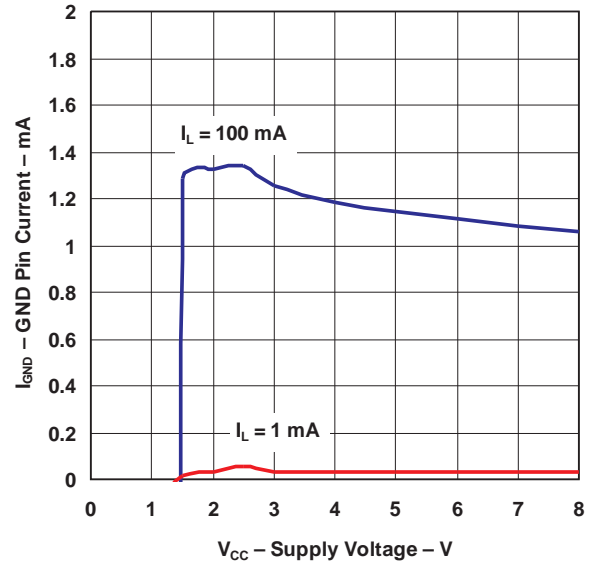

**GROUND CURRENT
vs
SUPPLY VOLTAGE**

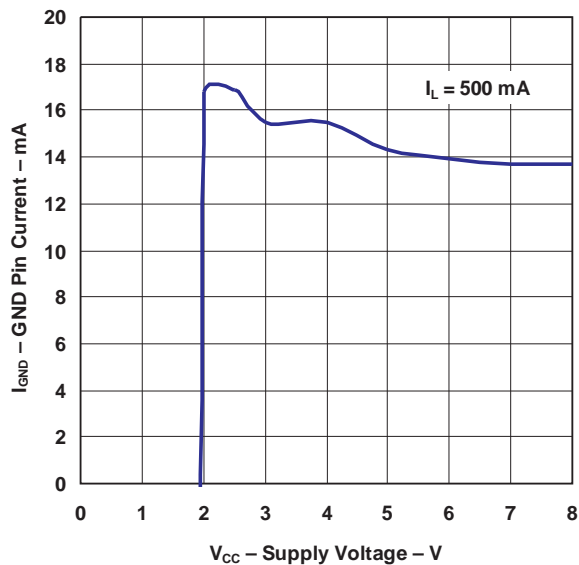

**OUTPUT VOLTAGE
vs
LOAD CURRENT**

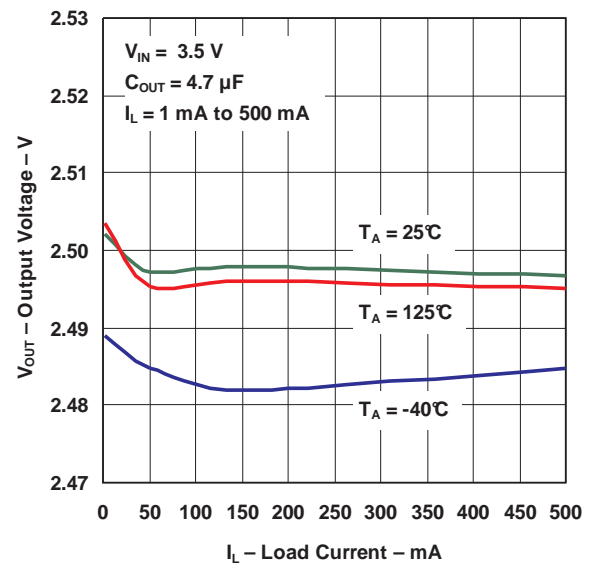

TYPICAL CHARACTERISTICS (continued)

OUTPUT IMPEDANCE
VS
FREQUENCY

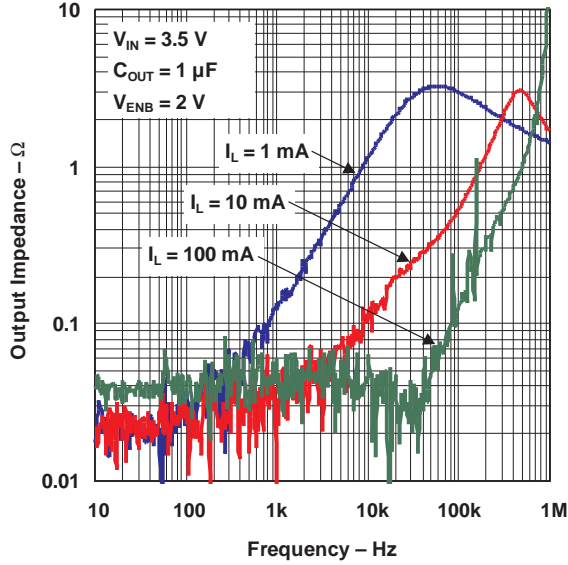

OUTPUT IMPEDANCE
VS
FREQUENCY

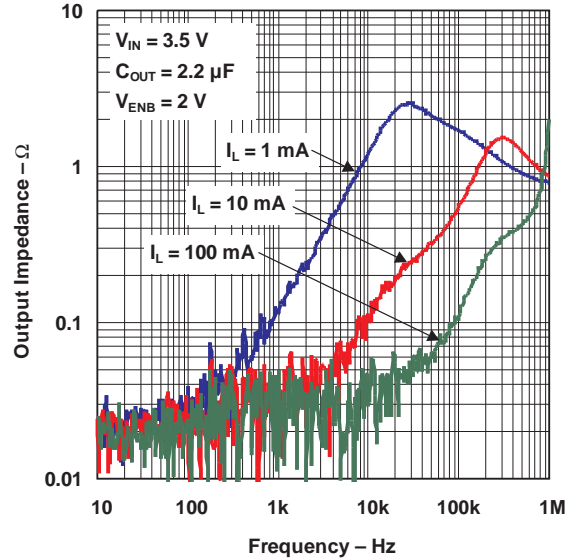

OUTPUT VOLTAGE
VS
INPUT VOLTAGE

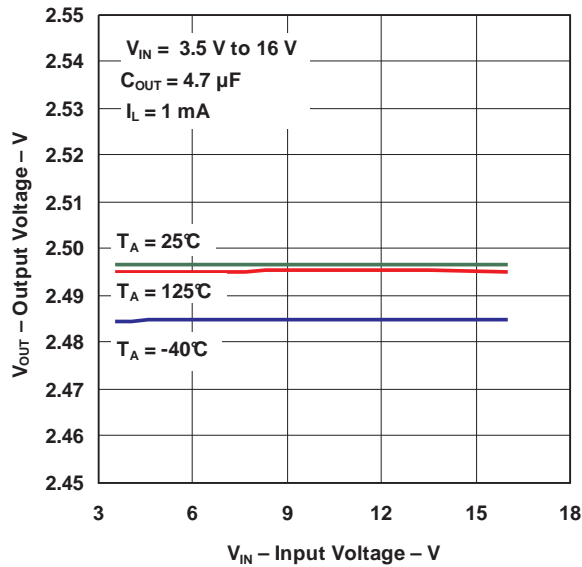

LOAD REGULATION

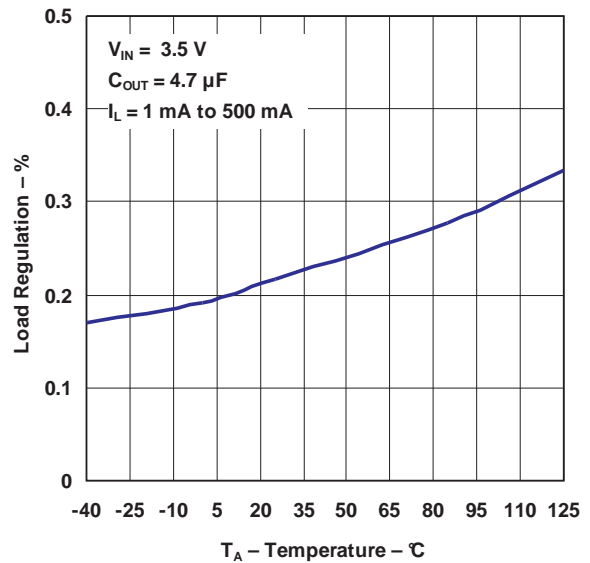

TYPICAL CHARACTERISTICS (continued)

LINE REGULATION

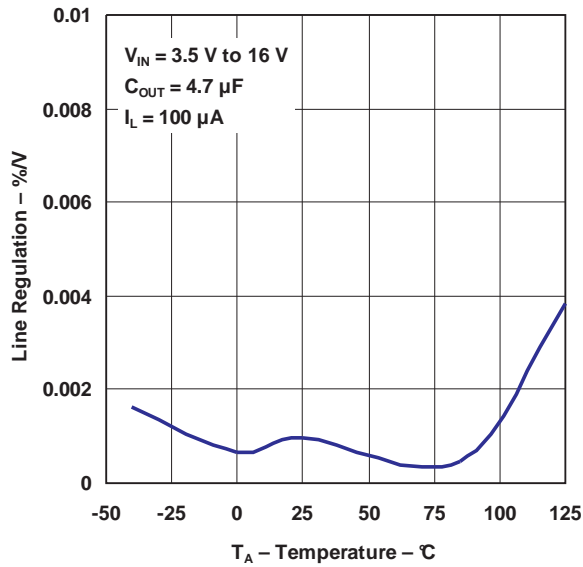

LOAD TRANSIENT RESPONSE

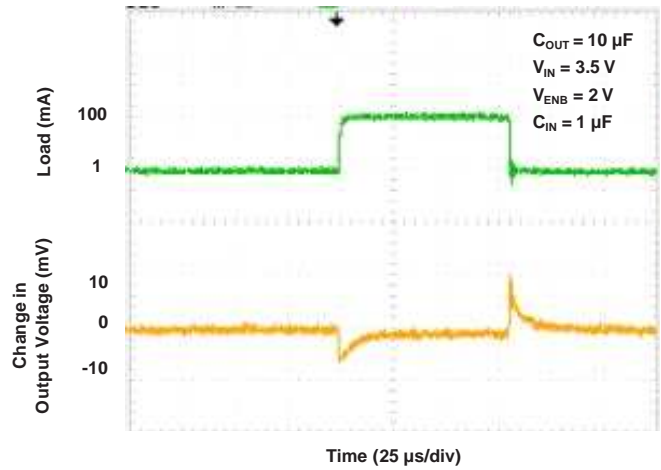

LOAD TRANSIENT RESPONSE

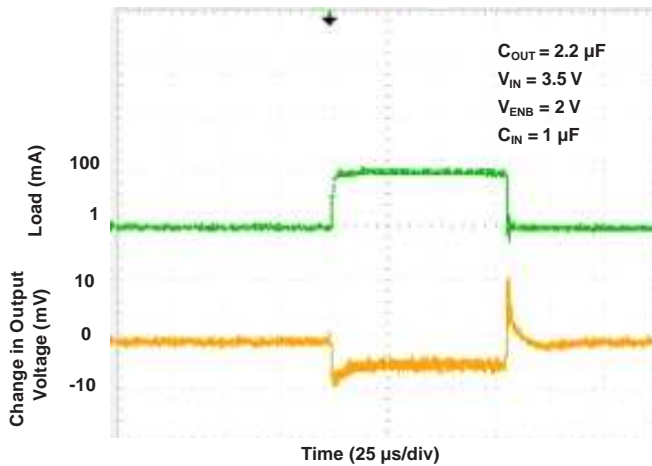

LOAD TRANSIENT RESPONSE

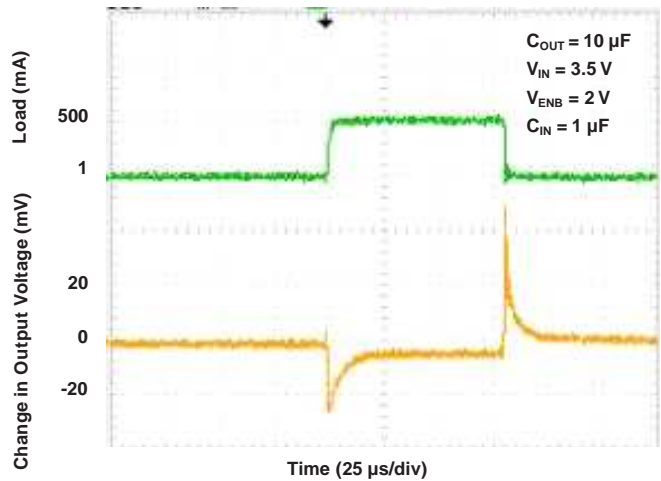

TYPICAL CHARACTERISTICS (continued)

LOAD TRANSIENT RESPONSE

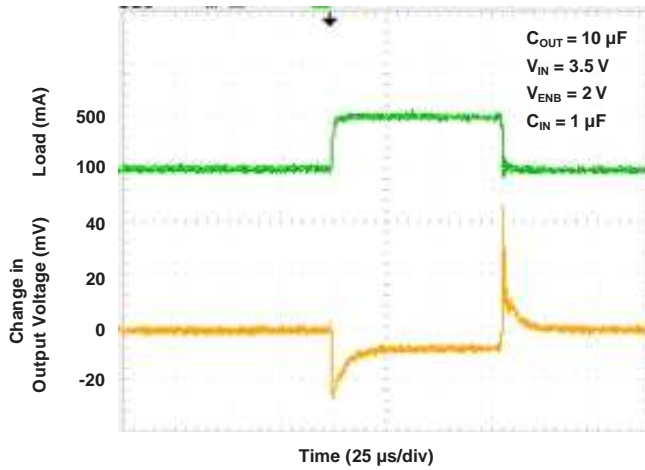

LINE TRANSIENT RESPONSE

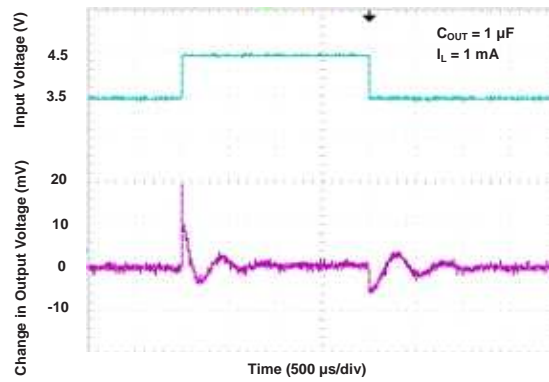

LINE TRANSIENT RESPONSE

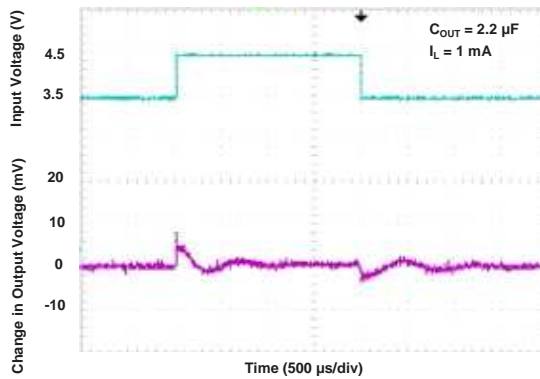

LINE TRANSIENT RESPONSE

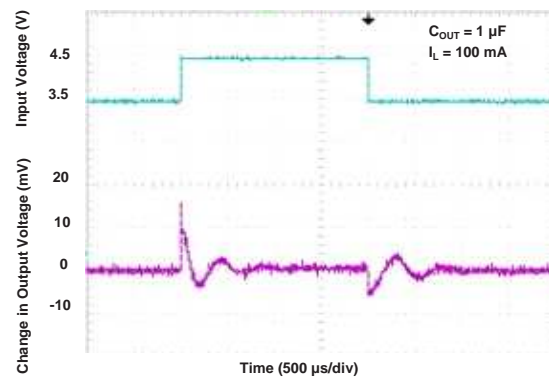

LINE TRANSIENT RESPONSE

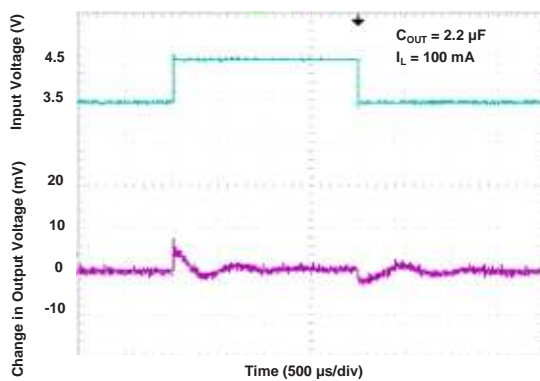

LINE TRANSIENT RESPONSE

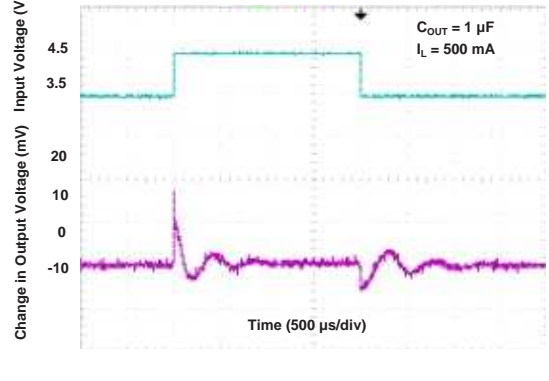

TYPICAL CHARACTERISTICS (continued)

LINE TRANSIENT RESPONSE

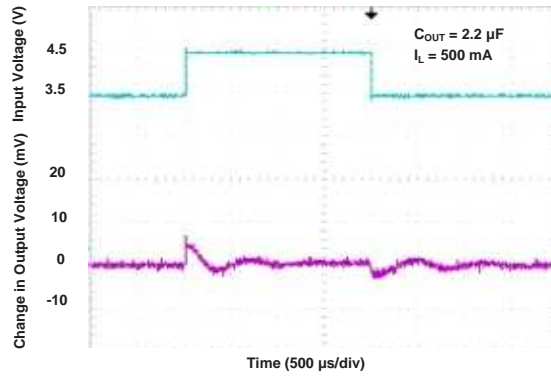

TURN-ON TIME

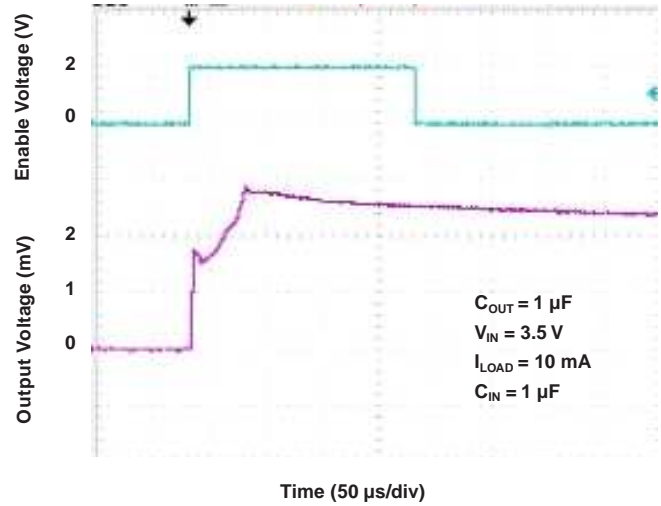

TURN-ON TIME

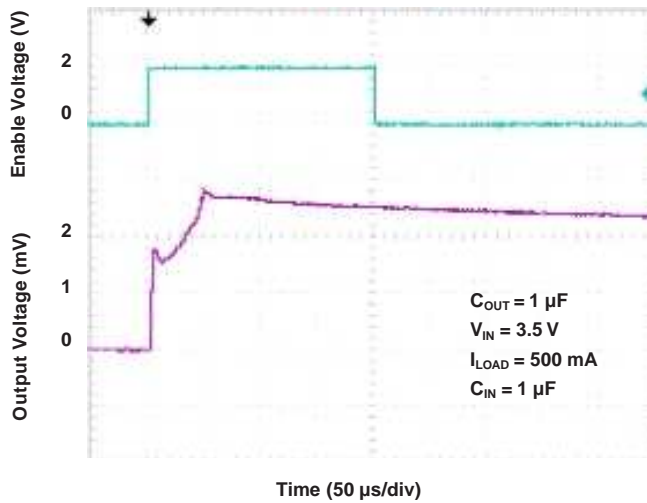

TURN-ON TIME

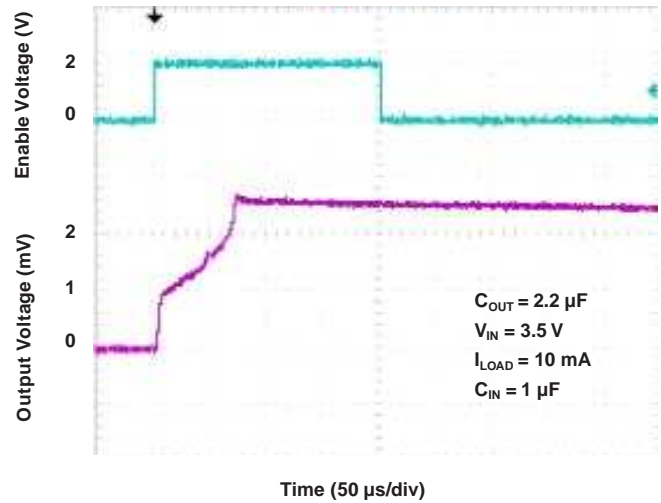

TYPICAL CHARACTERISTICS (continued)

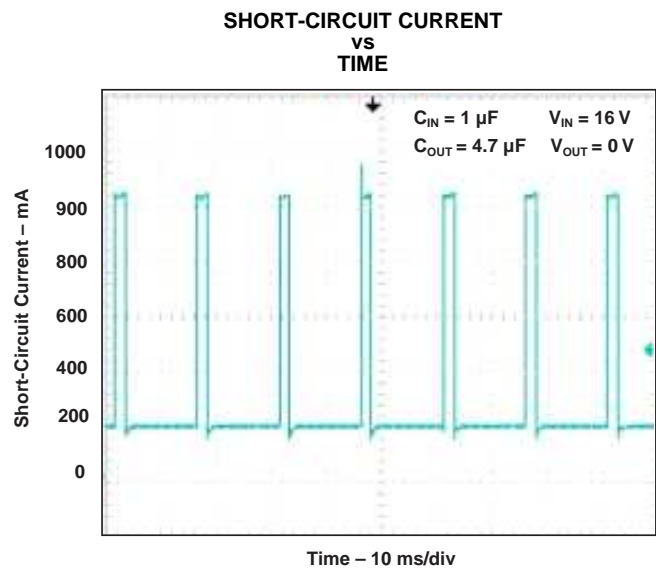
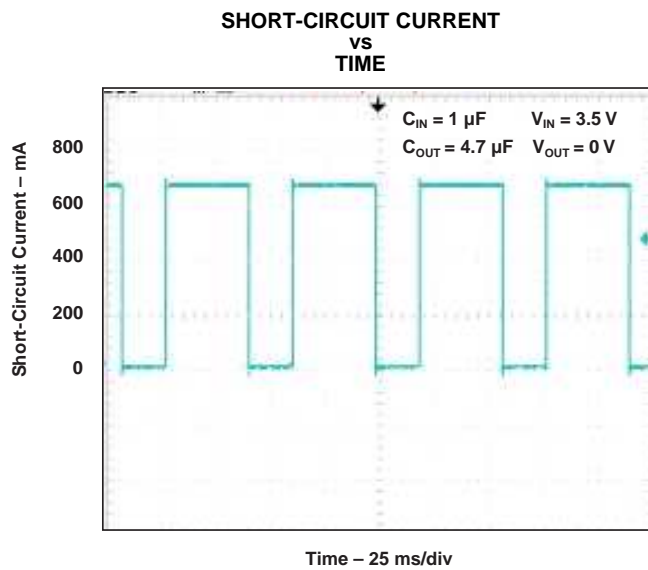
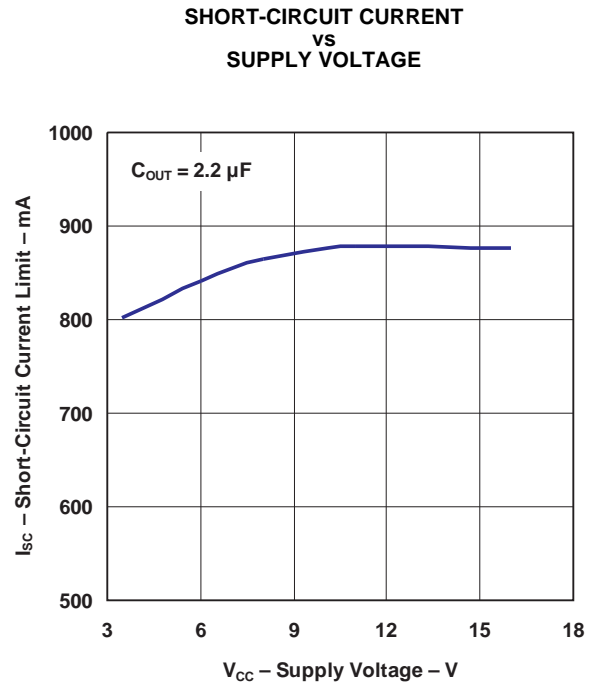
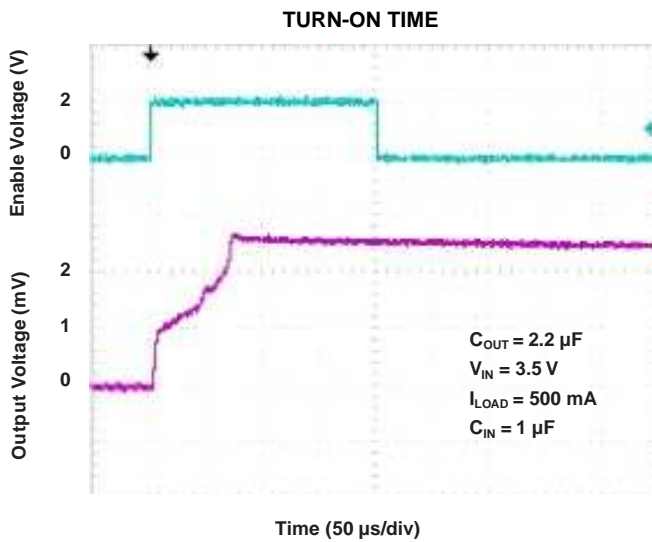

APPLICATION INFORMATION

Adjustable Output Voltage

The TL5209 develops a 1.242-V reference voltage, V_{REF} , between the output and the adjust terminal. As shown in Figure 2, this voltage is applied across resistor R1 to generate a constant current. The current I_{ADJ} from the ADJ terminal could introduce dc offset to the output. Because, this offset is very small (about 50 nA), it can be ignored. The constant current then flows through the output set resistor R2 and sets the output voltage to the desired level.

The TL5209 adjustable output should not be adjusted above $6.75\text{ V} \pm 10\%$ due to the internal zener diode clamping the output voltage above 6.75 V.

Although I_{ADJ} is very small, limit R2 to $\leq 470\text{ k}\Omega$ for optimum performance.

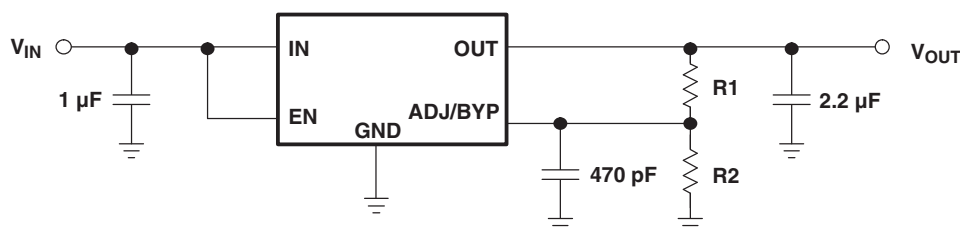

- A. $V_{OUT} = 1.242\text{ V} (1 + R2/R1)$
- B. R2 should be $\leq 470\text{ k}\Omega$ for optimal performance.
- C. Maximum $V_{OUT} = 6.75\text{ V} \pm 10\%$

Figure 2. Low-Noise Adjustable Regulator

Enable/Shutdown

The EN pin is CMOS-logic compatible. When EN is held high ($>2\text{ V}$), the regulator is active. Likewise, applying a low signal ($<0.4\text{ V}$ at 25°C) to EN or leaving it open shuts down the regulator. If the enable/shutdown feature is not needed, EN should be tied to V_{IN} .

Input Capacitor

If the input of the regulator is located more than ten inches from the power-supply filter, or if a battery is used to power the regulator, a minimum 1- μF input capacitor is recommended.

Output Capacitor

As with all PNP regulators, an output capacitor is needed for stability. The required minimum size of this output capacitor depends on several factors, one of which is whether a bypass capacitor is used.

- With no bypass capacitor, a minimum C_{OUT} of 1 μF is recommended.
- With a bypass capacitor of 470 pF (see Figure 2), a minimum C_{OUT} of 2.2 μF is recommended.
- Larger values of C_{OUT} are beneficial, because they improve the regulator transient response.

Another factor that can determine the minimum size of the output capacitor is the load current. At low loads, a smaller output capacitor is needed for stability.

The equivalent series resistance (ESR) of the output capacitor also can affect regulator stability. C_{OUT} should have an ESR of $\approx 1\ \Omega$, and it should have a resonant frequency above 1 MHz. Too low an ESR can cause the output to have a low-amplitude oscillation and/or underdamped transient response. Most tantalum or aluminum electrolytic capacitors can be used for the output capacitors. However, care should be used at low temperatures, because aluminum electrolytics use electrolytes that can freeze at low temperature ($\approx -30^\circ\text{C}$). Solid tantalum capacitors do not exhibit this problem and should be used below -25°C .

APPLICATION INFORMATION (continued)

Bypass Capacitor

An optional bypass capacitor, C_{BYP} , can be externally connected to the regulator via the BYP pin for improved noise performance. Connected to the internal voltage divider and the error amplifier of the regulator, this bypass capacitor filters the noise of the internal reference and reduces the noise effects on the error amplifier. The overall result is a significant drop in output noise of the regulator. A 470-pF bypass capacitor is recommended.

Adding a bypass capacitor has several effects on the regulator that must be taken into account. First, the bypass capacitor reduces the phase margin of the regulator and, thus, the minimum C_{OUT} needs to be increased to 2.2 μF , as previously mentioned. Second, upon startup of the regulator, the bypass capacitor has an effect on the regulator turn-on time. If a slow ramp-up of the output is needed, larger values of C_{BYP} should be used. Conversely, if a fast ramp-up of the output is needed, use a smaller C_{BYP} or none at all.

If a bypass capacitor is not needed, BYP should be left open.

Low-Voltage Operation

When using the TL5209 in voltage-sensitive applications, special considerations are required. If appropriate output and bypass capacitors are not chosen properly, these devices may experience a temporary overshoot of their nominal voltages.

At start-up, the full input voltage is initially applied across the regulator pass transistor, causing it to be temporarily fully turned on. By contrast, the error amplifier and voltage-reference circuits, being powered from the output, are not powered up as fast. In order to slow down the output ramp and give the error amplifier time to respond, select larger values of output and bypass capacitors. The longer ramp time of the output allows the regulator enough time to respond and keeps the output from overshooting its nominal value.

To prevent an overshoot when starting up into a light load ($\approx 100 \mu\text{A}$), 4.7- μF and 470-pF capacitors are recommended for the output and bypass capacitors, respectively. At higher loads, 10- μF and 470-pF capacitors should be used.

If the application is not too sensitive to regulator overshoot, both the output capacitor and bypass capacitor (if applicable) can be reduced.

PACKAGING INFORMATION

Orderable Device	Status ⁽¹⁾	Package Type	Package Drawing	Pins	Package Qty	Eco Plan ⁽²⁾	Lead/Ball Finish	MSL Peak Temp ⁽³⁾
TL5209DR	ACTIVE	SOIC	D	8	2500	Green (RoHS & no Sb/Br)	CU NIPDAU	Level-1-260C-UNLIM
TL5209DRG4	ACTIVE	SOIC	D	8	2500	Green (RoHS & no Sb/Br)	CU NIPDAU	Level-1-260C-UNLIM

⁽¹⁾ The marketing status values are defined as follows:

ACTIVE: Product device recommended for new designs.

LIFEBUY: TI has announced that the device will be discontinued, and a lifetime-buy period is in effect.

NRND: Not recommended for new designs. Device is in production to support existing customers, but TI does not recommend using this part in a new design.

PREVIEW: Device has been announced but is not in production. Samples may or may not be available.

OBsolete: TI has discontinued the production of the device.

⁽²⁾ Eco Plan - The planned eco-friendly classification: Pb-Free (RoHS), Pb-Free (RoHS Exempt), or Green (RoHS & no Sb/Br) - please check <http://www.ti.com/productcontent> for the latest availability information and additional product content details.

TBD: The Pb-Free/Green conversion plan has not been defined.

Pb-Free (RoHS): TI's terms "Lead-Free" or "Pb-Free" mean semiconductor products that are compatible with the current RoHS requirements for all 6 substances, including the requirement that lead not exceed 0.1% by weight in homogeneous materials. Where designed to be soldered at high temperatures, TI Pb-Free products are suitable for use in specified lead-free processes.

Pb-Free (RoHS Exempt): This component has a RoHS exemption for either 1) lead-based flip-chip solder bumps used between the die and package, or 2) lead-based die adhesive used between the die and leadframe. The component is otherwise considered Pb-Free (RoHS compatible) as defined above.

Green (RoHS & no Sb/Br): TI defines "Green" to mean Pb-Free (RoHS compatible), and free of Bromine (Br) and Antimony (Sb) based flame retardants (Br or Sb do not exceed 0.1% by weight in homogeneous material)

⁽³⁾ MSL, Peak Temp. -- The Moisture Sensitivity Level rating according to the JEDEC industry standard classifications, and peak solder temperature.

Important Information and Disclaimer:The information provided on this page represents TI's knowledge and belief as of the date that it is provided. TI bases its knowledge and belief on information provided by third parties, and makes no representation or warranty as to the accuracy of such information. Efforts are underway to better integrate information from third parties. TI has taken and continues to take reasonable steps to provide representative and accurate information but may not have conducted destructive testing or chemical analysis on incoming materials and chemicals. TI and TI suppliers consider certain information to be proprietary, and thus CAS numbers and other limited information may not be available for release.

In no event shall TI's liability arising out of such information exceed the total purchase price of the TI part(s) at issue in this document sold by TI to Customer on an annual basis.

TAPE AND REEL INFORMATION

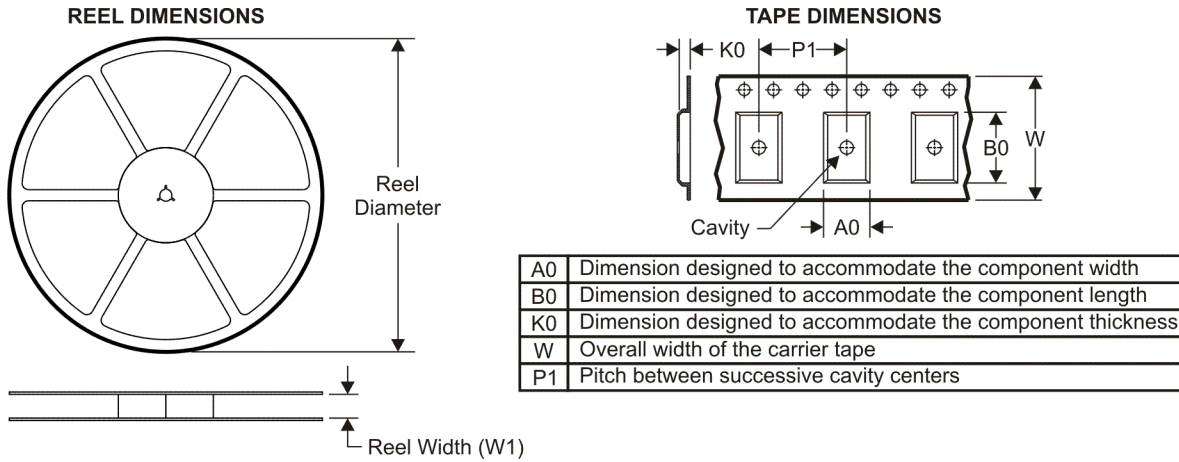

QUADRANT ASSIGNMENTS FOR PIN 1 ORIENTATION IN TAPE

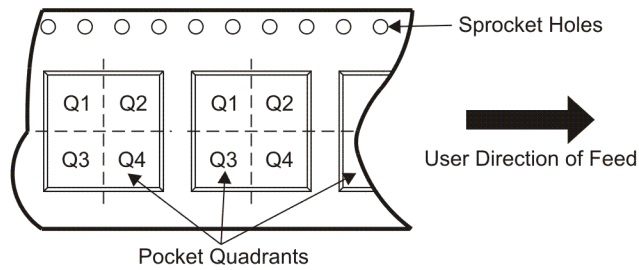

*All dimensions are nominal

Device	Package Type	Package Drawing	Pins	SPQ	Reel Diameter (mm)	Reel Width W1 (mm)	A0 (mm)	B0 (mm)	K0 (mm)	P1 (mm)	W (mm)	Pin1 Quadrant
TL5209DR	SOIC	D	8	2500	330.0	12.4	6.4	5.2	2.1	8.0	12.0	Q1

TAPE AND REEL BOX DIMENSIONS



*All dimensions are nominal

Device	Package Type	Package Drawing	Pins	SPQ	Length (mm)	Width (mm)	Height (mm)
TL5209DR	SOIC	D	8	2500	340.5	338.1	20.6

D (R-PDSO-G8)

PLASTIC SMALL-OUTLINE PACKAGE

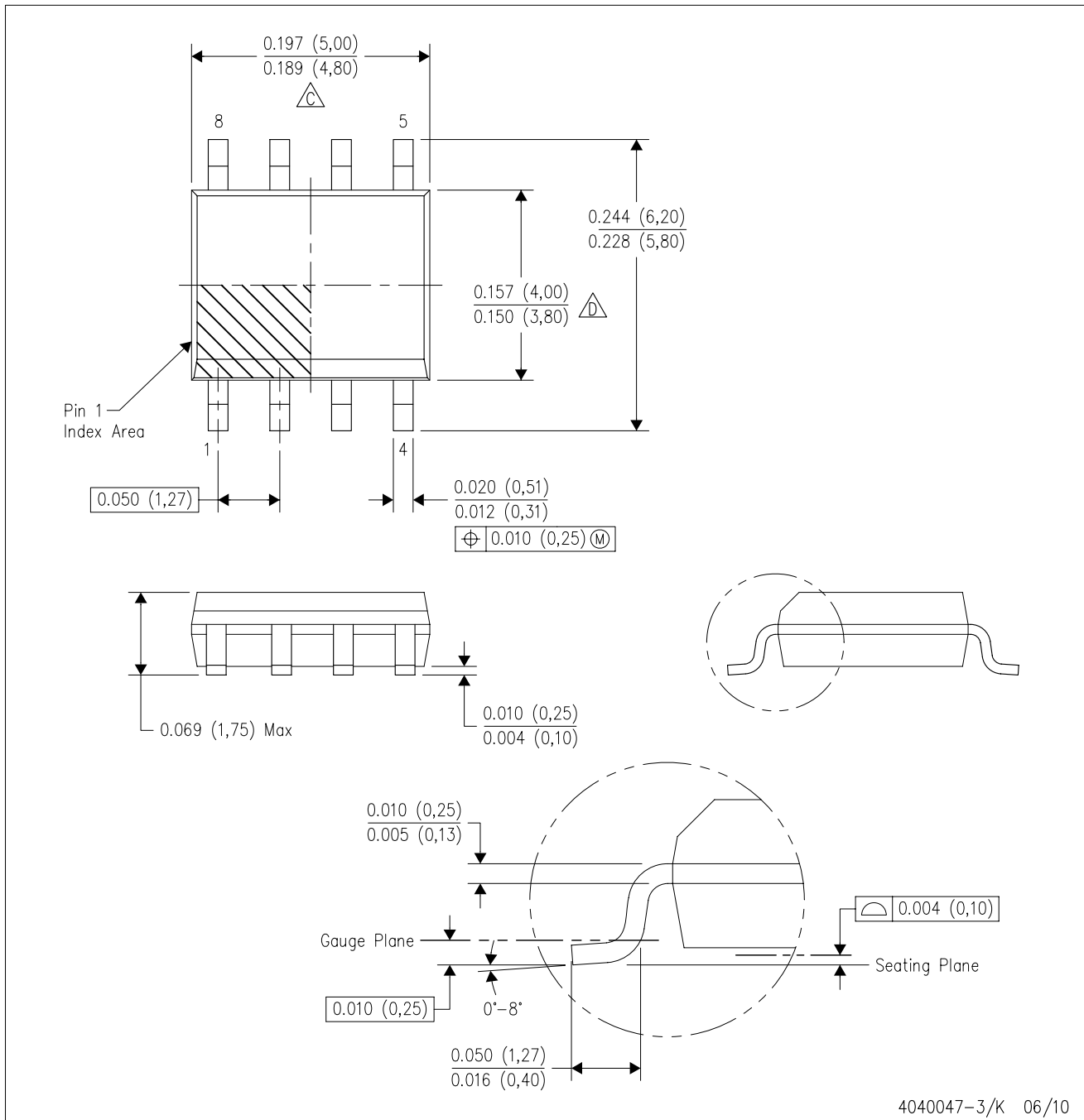

- NOTES:
- A. All linear dimensions are in inches (millimeters).
 - B. This drawing is subject to change without notice.
 - $\triangle C$ Body length does not include mold flash, protrusions, or gate burrs. Mold flash, protrusions, or gate burrs shall not exceed .006 (0,15) per end.
 - $\triangle D$ Body width does not include interlead flash. Interlead flash shall not exceed .017 (0,43) per side.
 - E. Reference JEDEC MS-012 variation AA.

IMPORTANT NOTICE

Texas Instruments Incorporated and its subsidiaries (TI) reserve the right to make corrections, modifications, enhancements, improvements, and other changes to its products and services at any time and to discontinue any product or service without notice. Customers should obtain the latest relevant information before placing orders and should verify that such information is current and complete. All products are sold subject to TI's terms and conditions of sale supplied at the time of order acknowledgment.

TI warrants performance of its hardware products to the specifications applicable at the time of sale in accordance with TI's standard warranty. Testing and other quality control techniques are used to the extent TI deems necessary to support this warranty. Except where mandated by government requirements, testing of all parameters of each product is not necessarily performed.

TI assumes no liability for applications assistance or customer product design. Customers are responsible for their products and applications using TI components. To minimize the risks associated with customer products and applications, customers should provide adequate design and operating safeguards.

TI does not warrant or represent that any license, either express or implied, is granted under any TI patent right, copyright, mask work right, or other TI intellectual property right relating to any combination, machine, or process in which TI products or services are used. Information published by TI regarding third-party products or services does not constitute a license from TI to use such products or services or a warranty or endorsement thereof. Use of such information may require a license from a third party under the patents or other intellectual property of the third party, or a license from TI under the patents or other intellectual property of TI.

Reproduction of TI information in TI data books or data sheets is permissible only if reproduction is without alteration and is accompanied by all associated warranties, conditions, limitations, and notices. Reproduction of this information with alteration is an unfair and deceptive business practice. TI is not responsible or liable for such altered documentation. Information of third parties may be subject to additional restrictions.

Resale of TI products or services with statements different from or beyond the parameters stated by TI for that product or service voids all express and any implied warranties for the associated TI product or service and is an unfair and deceptive business practice. TI is not responsible or liable for any such statements.

TI products are not authorized for use in safety-critical applications (such as life support) where a failure of the TI product would reasonably be expected to cause severe personal injury or death, unless officers of the parties have executed an agreement specifically governing such use. Buyers represent that they have all necessary expertise in the safety and regulatory ramifications of their applications, and acknowledge and agree that they are solely responsible for all legal, regulatory and safety-related requirements concerning their products and any use of TI products in such safety-critical applications, notwithstanding any applications-related information or support that may be provided by TI. Further, Buyers must fully indemnify TI and its representatives against any damages arising out of the use of TI products in such safety-critical applications.

TI products are neither designed nor intended for use in military/aerospace applications or environments unless the TI products are specifically designated by TI as military-grade or "enhanced plastic." Only products designated by TI as military-grade meet military specifications. Buyers acknowledge and agree that any such use of TI products which TI has not designated as military-grade is solely at the Buyer's risk, and that they are solely responsible for compliance with all legal and regulatory requirements in connection with such use.

TI products are neither designed nor intended for use in automotive applications or environments unless the specific TI products are designated by TI as compliant with ISO/TS 16949 requirements. Buyers acknowledge and agree that, if they use any non-designated products in automotive applications, TI will not be responsible for any failure to meet such requirements.

Following are URLs where you can obtain information on other Texas Instruments products and application solutions:

Products		Applications	
Amplifiers	amplifier.ti.com	Audio	www.ti.com/audio
Data Converters	dataconverter.ti.com	Automotive	www.ti.com/automotive
DLP® Products	www.dlp.com	Communications and Telecom	www.ti.com/communications
DSP	dsp.ti.com	Computers and Peripherals	www.ti.com/computers
Clocks and Timers	www.ti.com/clocks	Consumer Electronics	www.ti.com/consumer-apps
Interface	interface.ti.com	Energy	www.ti.com/energy
Logic	logic.ti.com	Industrial	www.ti.com/industrial
Power Mgmt	power.ti.com	Medical	www.ti.com/medical
Microcontrollers	microcontroller.ti.com	Security	www.ti.com/security
RFID	www.ti-rfid.com	Space, Avionics & Defense	www.ti.com/space-avionics-defense
RF/IF and ZigBee® Solutions	www.ti.com/lprf	Video and Imaging	www.ti.com/video
		Wireless	www.ti.com/wireless-apps

Mailing Address: Texas Instruments, Post Office Box 655303, Dallas, Texas 75265
Copyright © 2010, Texas Instruments Incorporated