

## Description:

This N-Channel MOSFET uses advanced SGT technology and design to provide excellent  $R_{DS(on)}$  with low gate charge.

It can be used in a wide variety of applications.

## Features:

- 1)  $V_{DS}=100V, I_D=170A, R_{DS(ON)}<3m\Omega @V_{GS}=10V$
- 2) Low gate charge.
- 3) Green device available.
- 4) Advanced high cell density trench technology for ultra  $R_{DS(ON)}$ .
- 5) Excellent package for good heat dissipation.

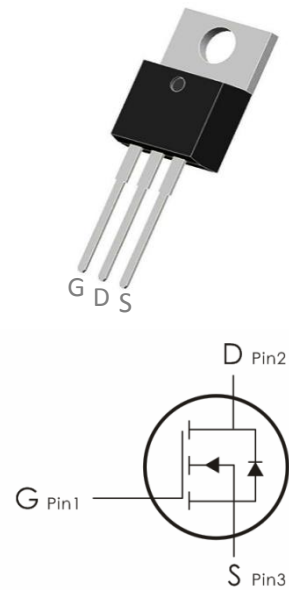

## Absolute Maximum Ratings: ( $T_c=25^\circ\text{C}$ unless otherwise noted)

Symbol	Parameter	Ratings	Units
$V_{DS}$	Drain-Source Voltage	100	V
$V_{GS}$	Gate-Source Voltage	$\pm 20$	V
$I_D$	Continuous Drain Current <sup>1</sup>	170	A
	Pulsed Drain Current <sup>2</sup>	510	
$E_{AS}$	Single Pulse Avalanche Energy <sup>4</sup>	540	mJ
$P_D$	Power Dissipation <sup>3</sup>	340	W
$T_J, T_{STG}$	Operating and Storage Junction Temperature Range	-55-+150	$^\circ\text{C}$

## Thermal Characteristics:

Symbol	Parameter	Max	Units
$R_{\theta JC}$	Thermal Resistance, Junction to Case	0.37	$^\circ\text{C}/\text{W}$
$R_{\theta JA}$	Thermal Resistance, Junction to Ambient <sup>5</sup>	62	

**Electrical Characteristics:** ( $T_C=25^\circ\text{C}$  unless otherwise noted)

Symbol	Parameter	Conditions	Min	Typ	Max	Units
<b>Off Characteristics</b>						
$BV_{DSS}$	Drain-Source Breakdown Voltage	$V_{GS}=0V, I_D=250\ \mu\text{A}$	100		---	V
$I_{DSS}$	Zero Gate Voltage Drain Current	$V_{GS}=0V, V_{DS}=100V$	---	---	1	$\mu\text{A}$
$I_{GSS}$	Gate-Source Leakage Current	$V_{GS}=\pm 20V, V_{DS}=0A$	---	---	$\pm 100$	nA
<b>On Characteristics</b>						
$V_{GS(th)}$	GATE-Source Threshold Voltage	$V_{GS}=V_{DS}, I_D=250\ \mu\text{A}$	2		4	V
$R_{DS(ON)}$	Drain-Source On Resistance	$V_{GS}=10V, I_D=30A$	---	2.8	3	$\text{m}\Omega$
<b>Dynamic Characteristics</b>						
$C_{iss}$	Input Capacitance <sup>4</sup>	$V_{DS}=50V, V_{GS}=0V, f=1\text{MHz}$	---	9644.2	---	pF
$C_{oss}$	Output Capacitance <sup>4</sup>		---	1300.4	---	
$C_{rss}$	Reverse Transfer Capacitance <sup>4</sup>		---	24.6	---	
<b>Switching Characteristics</b>						
$t_{d(on)}$	Turn-On Delay Time	$V_{DD}=50V, I_D=20A,$ $R_{GEN}=2\ \Omega, V_{GS}=10V$	---	43.7		ns
$t_r$	Rise Time		---	19.7		ns
$t_{d(off)}$	Turn-Off Delay Time		---	102.3		ns
$t_f$	Fall Time		---	22.5		ns
$Q_g$	Total Gate Charge	$V_{GS}=10V, V_{DS}=50V,$ $I_D=20A$	---	114.5		nC
$Q_{gs}$	Gate-Source Charge		---	34.8	---	nC
$Q_{gd}$	Gate-Drain "Miller" Charge		---	23.2	---	nC
$V_{plateau}$	Gate plateau voltage				4.6	
<b>Drain-Source Diode Characteristics</b>						
$V_{SD}$	Source-Drain Diode Forward Voltage	$V_{GS}=0V, I_S=20A$	---	---	1.3	V
$I_S$	Diode Forward Current	$V_{GS}<V_{th}$	---	---	170	A
$I_{SP}$	Pulsed source current					510

<b>Trr</b>	Reverse Recovery Time	$I_S=20\text{ A,}$ $di/dt=100\text{ A}/\mu\text{s}$	---	105	---	NS
<b>Qrr</b>	Reverse Recovery Charge		---	414.7	---	NC
<b>I<sub>rrm</sub></b>	Peak reverse recovery current			6.6		A

### Notes:

- 1) Calculated continuous current based on maximum allowable junction temperature.
- 2) Repetitive rating; pulse width limited by max. junction temperature.
- 3) Pd is based on max. junction temperature, using junction-case thermal resistance.
- 4)  $V_{DD}=50\text{ V}$ ,  $R_G=50\ \Omega$ ,  $L=0.3\text{ mH}$ , starting  $T_J=25\text{ }^\circ\text{C}$ .
- 5) The value of  $R_{\theta JA}$  is measured with the device mounted on 1 in 2 FR-4 board with 2oz. Copper, in a still air environment with  $T_a=25\text{ }^\circ\text{C}$ .

### Typical Characteristics: ( $T_C=25\text{ }^\circ\text{C}$ unless otherwise noted)

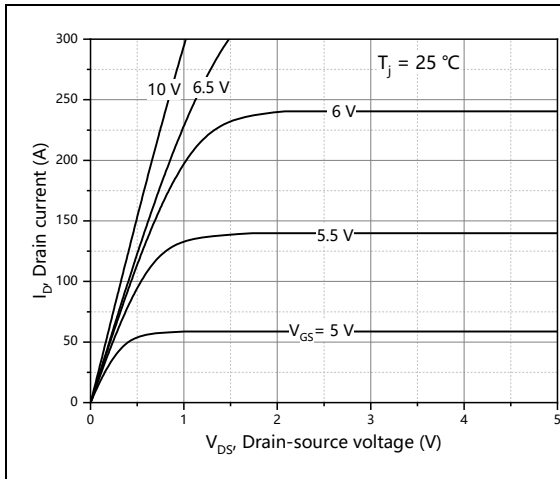

Figure 1, Typ. output characteristics

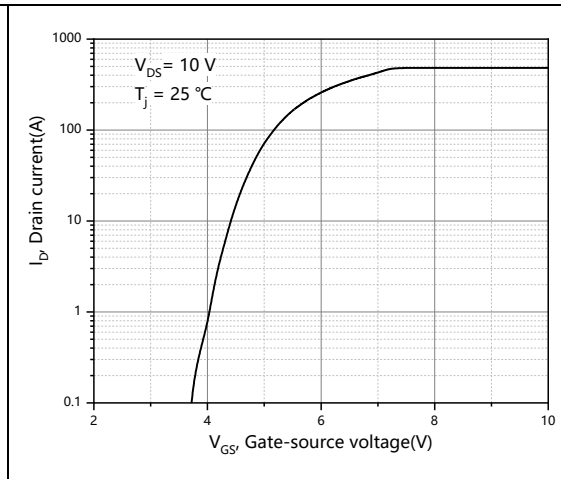

Figure 2, Typ. transfer characteristics

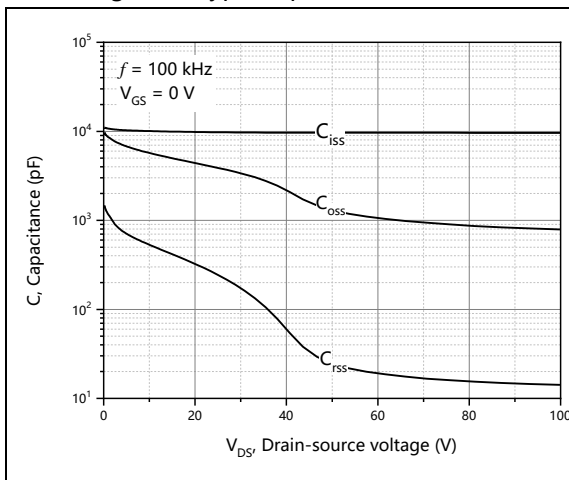

Figure 3, Typ. capacitances

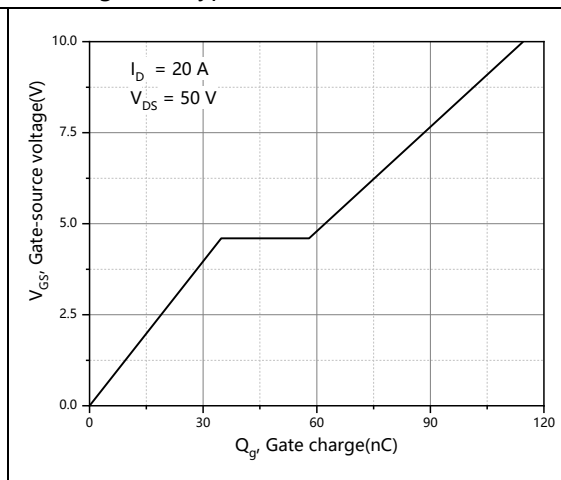

Figure 4, Typ. gate charge

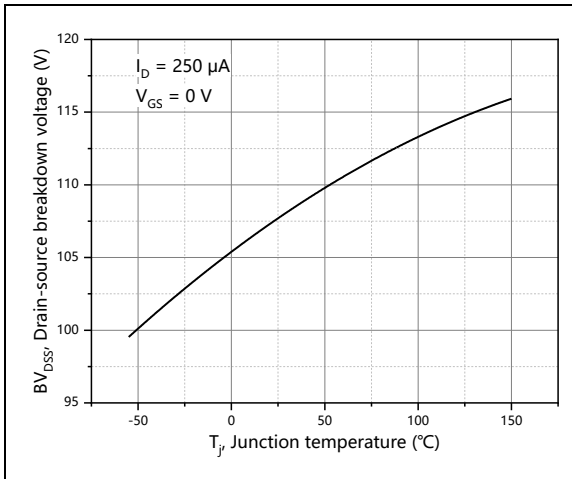

Figure 5, Drain-source breakdown voltage

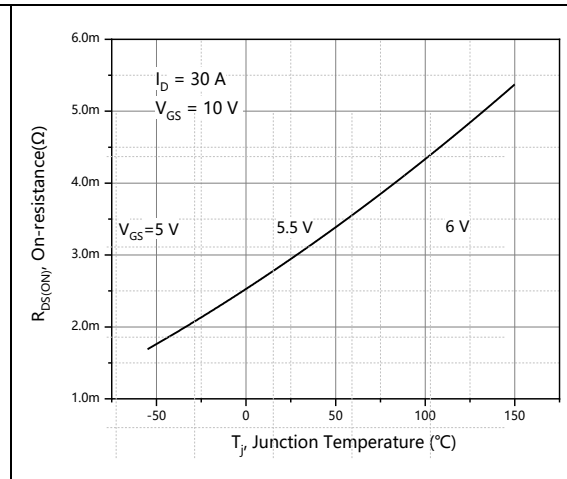

Figure 6, Drain-source on-state resistance

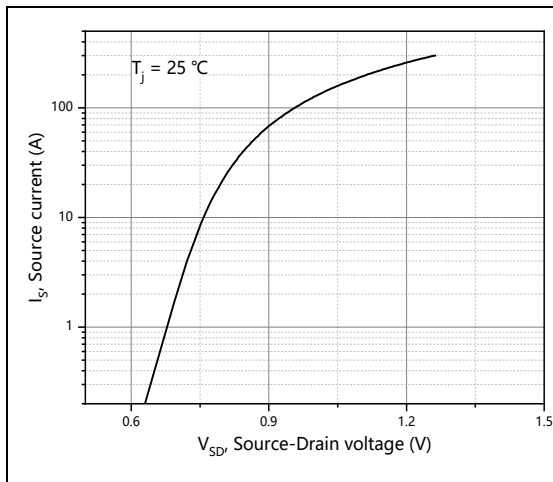

Figure 7, Forward characteristic of body diode

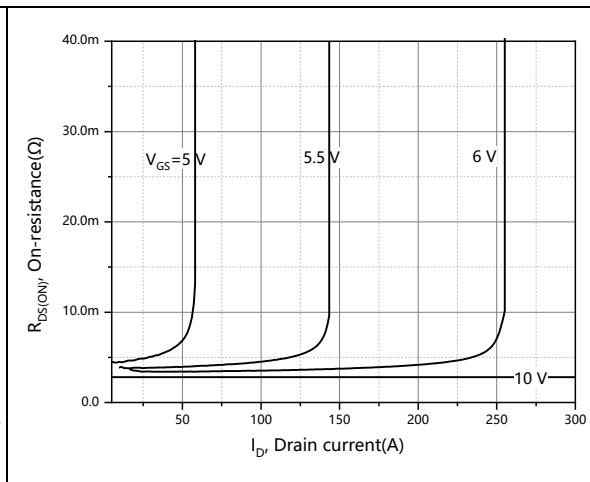

Figure 8, Drain-source on-state resistance

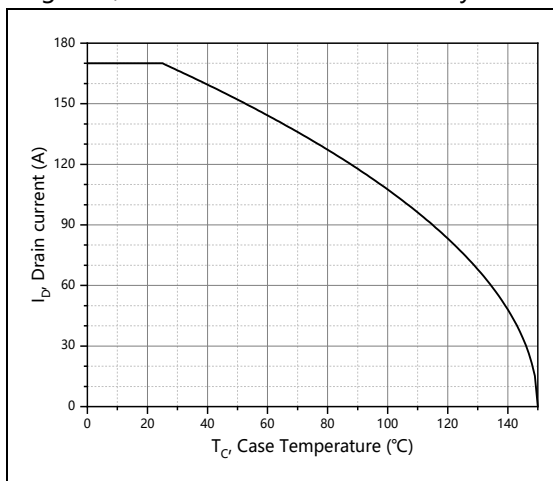

Figure 9, Drain current

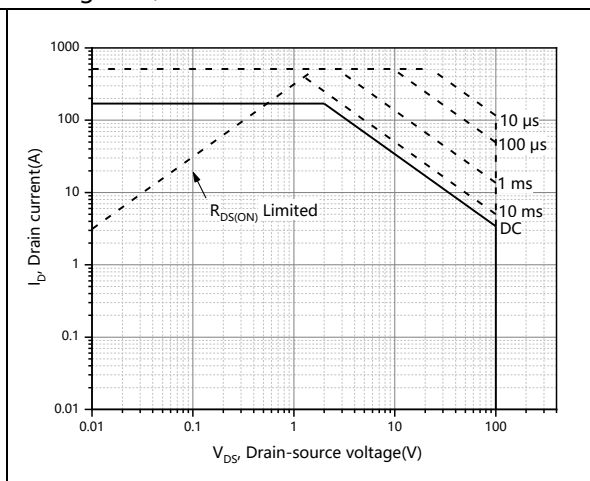
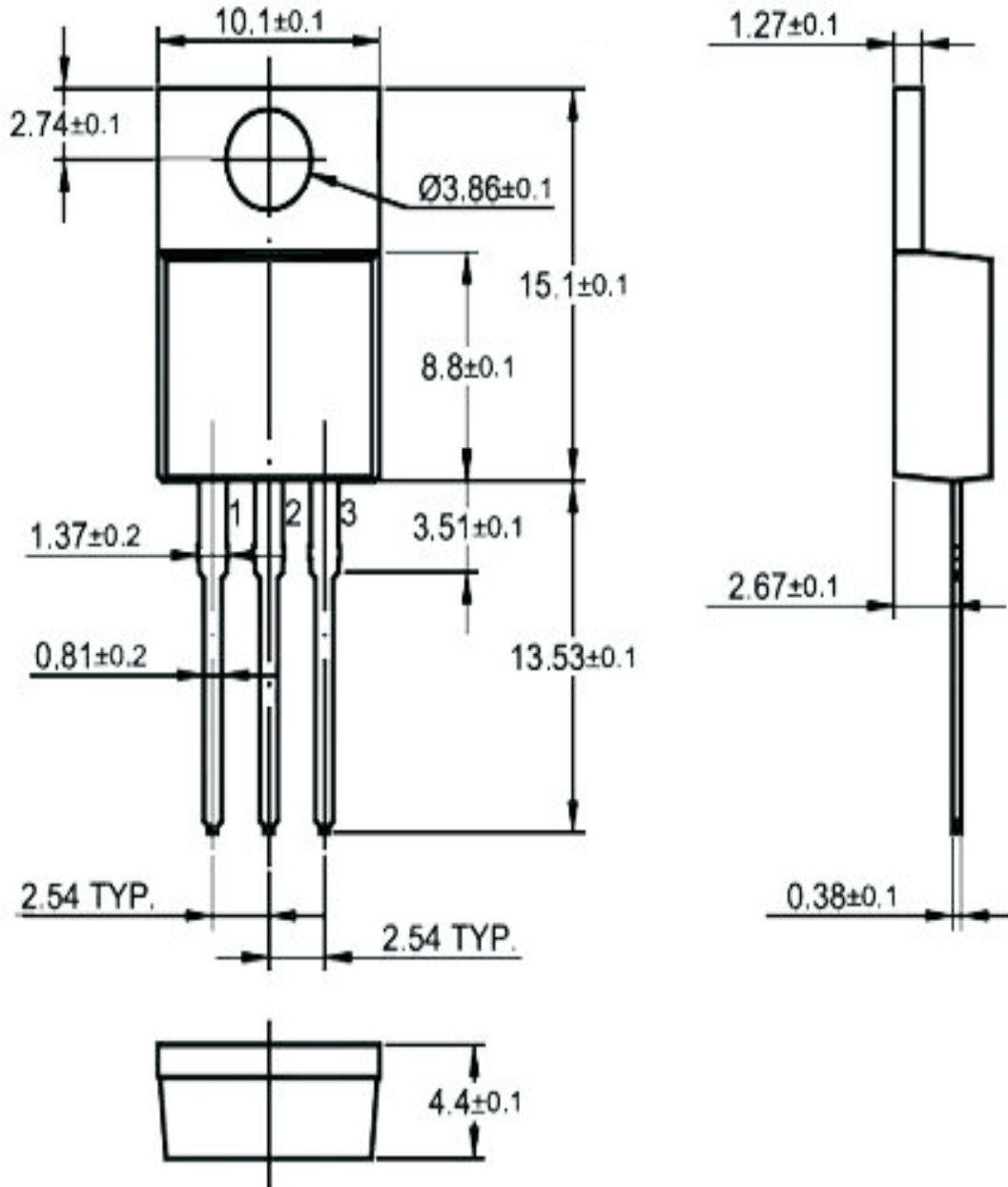

Figure 10, Safe operation area  $T_C=25\text{ }^\circ\text{C}$



0086-0755-8278-9056  
www.doingter.cn