

TOSHIBA e-MMC Module

8GB THGBMFG6C1LBAIL

INTRODUCTION

THGBMFG6C1LBAIL is 8GB density of e-MMC Module product housed in 153 ball BGA package. This unit is utilized advanced TOSHIBA NAND flash device(s) and controller chip assembled as Multi Chip Module. THGBMFG6C1LBAIL has an industry standard MMC protocol for easy use.

FEATURES

THGBMFG6C1LBAIL Interface

THGBMFG6C1LBAIL has the JEDEC/MMCA Version 5.1 interface with 1-I/O, 4-I/O and 8-I/O mode.
 (*) MMCA Version 5.1 is under discussion in JEDEC.

Pin Connection

P-WFBGA153-1113-0.50 (11.5mm x 13mm, H0.8mm max. package)

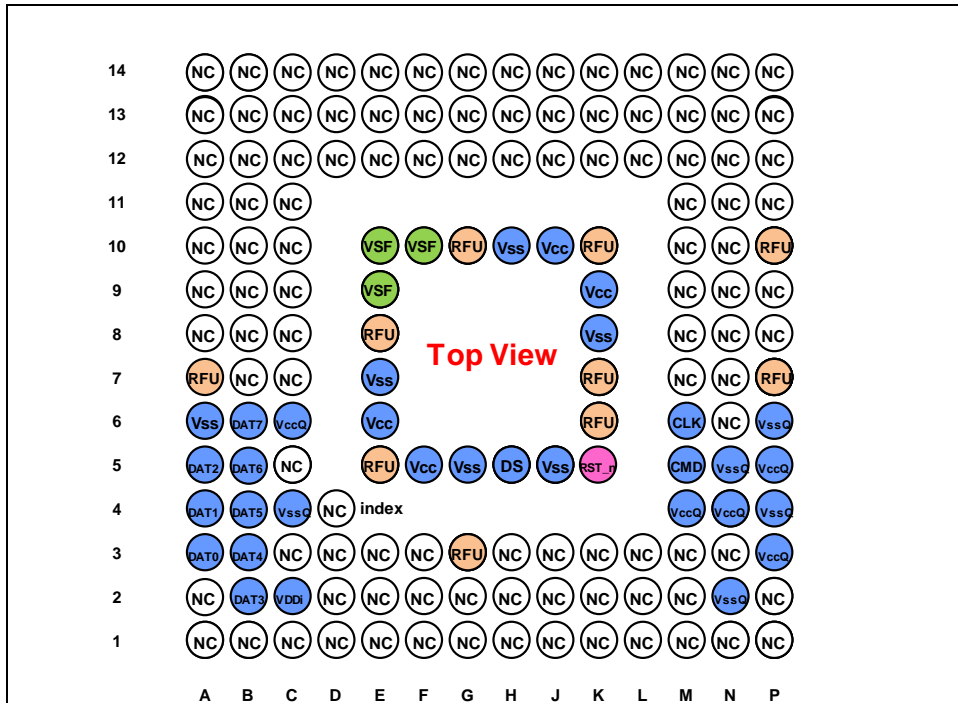

Pin Number	Name	Pin Number	Name	Pin Number	Name	Pin Number	Name
A3	DAT0	C2	VDDi	J5	Vss	N4	VccQ
A4	DAT1	C4	VssQ	J10	Vcc	N5	VssQ
A5	DAT2	C6	VccQ	K5	RST_n	P3	VccQ
A6	Vss	E6	Vcc	K8	Vss	P4	VssQ
B2	DAT3	E7	Vss	K9	Vcc	P5	VccQ
B3	DAT4	F5	Vcc	M4	VccQ	P6	VssQ
B4	DAT5	G5	Vss	M5	CMD		
B5	DAT6	H5	DS	M6	CLK		
B6	DAT7	H10	Vss	N2	VssQ		

NC: No Connect, shall be connected to ground or left floating.
 RFU: Reserved for Future Use, shall be left floating for future use.
 VSF: Vendor Specific Function, shall be left floating.

Part Numbers

Available e-MMC Module Products – Part Numbers

TOSHIBA Part Number	Density	Package Size	NAND Flash Type	Weight
THGBMFG6C1LBAIL	8GB	11.5mm x 13mm x 0.8mm(max)	1 x 64Gbit 15nm	0.17g typ.

Operating Temperature and Humidity Conditions

-25°C to +85°C, and 0%RH to 95%RH non-condensing

Storage Temperature and Humidity Conditions

-40°C to +85°C, and 0%RH to 95%RH non-condensing

Performance

X8 mode/ Sequential access (4MByte access size)

TOSHIBA Part Number	Density	NAND Flash Type	Interleave Operation	Frequency /Mode	VccQ	Typ. Performance [MB/sec]	
						Read	Write
THGBMFG6C1LBAIL	8GB	1 x 64Gbit 15nm	Non Interleave	52MHz/SDR	1.8V	45	35
					3.3V	45	35
				52MHz/DDR	1.8V	90	35
					3.3V	90	35
				HS200	1.8V	180	35
				HS400	1.8V	215	35

Power Supply

Vcc = 2.7V to 3.6V

VccQ = 1.7V to 1.95V / 2.7V to 3.6V

Operating Current (RMS)

The measurement for max RMS current is done as average RMS current consumption over a period of 100ms

TOSHIBA Part Number	Density	NAND Flash Type	Interleave Operation	Frequency /Mode	VccQ	Max Operating Current [mA]	
						Iccq	Icc
THGBMFG6C1LBAIL	8GB	1 x 64Gbit 15nm	Non Interleave	52MHz/SDR	1.8V	95	40
					3.3V	110	40
				52MHz/DDR	1.8V	120	40
					3.3V	140	40
				HS200	1.8V	175	40
				HS400	1.8V	220	40

Sleep Mode Current

TOSHIBA Part Number	Density	NAND Flash Type	Interleave Operation	Iccqs [μ A]		Iccqs+Iccs [μ A]	
				Typ. *1	Max. *2	Typ. *1	Max. *2
THGBMFG6C1LBAIL	8GB	1 x 64Gbit 15nm	Non Interleave	100	510	120	585

*1 : The conditions of typical values are 25°C and VccQ = 3.3V or 1.8V.

*2 : The conditions of maximum values are 85°C and VccQ = 3.6V or 1.95V.

Product Architecture

The diagram in Figure 1 illustrates the main functional blocks of the THGBMFG6C1LBAIL. Specification of the C_{REG} and recommended values of the C_{VCC} , and C_{VCCQ} in the Figure 1 are as follows.

Parameter	Symbol	Unit	Min.	Typ.	Max.	Remark
V _{DDi} capacitor value	C _{REG}	μF	0.10	-	2.2*	Except HS400
		μF	1.00	-	2.2*	HS400
V _{CC} capacitor value	C _{VCC}	μF	-	2.2 + 0.1	-	
V _{CCQ} capacitor value	C _{VCCQ}	μF	-	2.2 + 0.1	-	

* Toshiba recommends that the value should be usually applied as the value of C_{REG}.

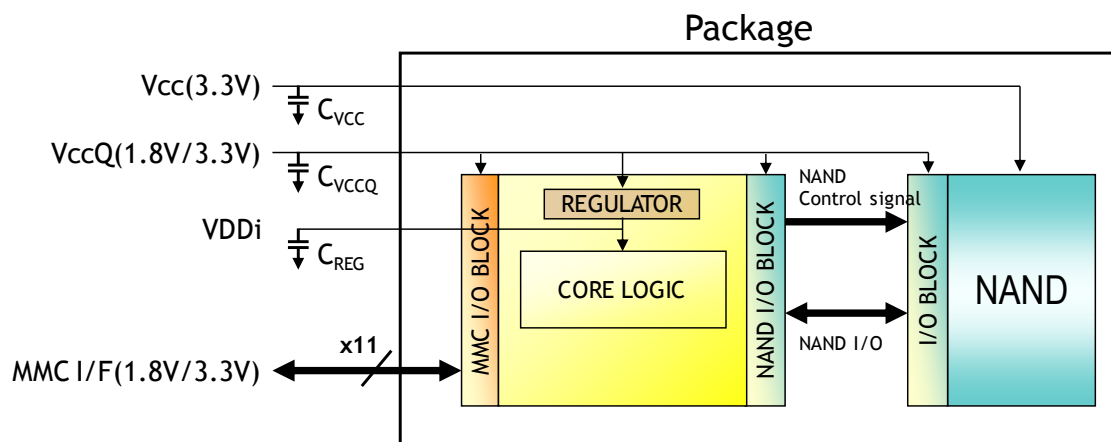

Figure 1 THGBMFG6C1LBAIL Block Diagram

PRODUCT SPECIFICATIONS

Package Dimensions

P-WFBGA153-1113-0.50 (11.5mm x 13mm, H0.8mm max. package)

Unit: mm

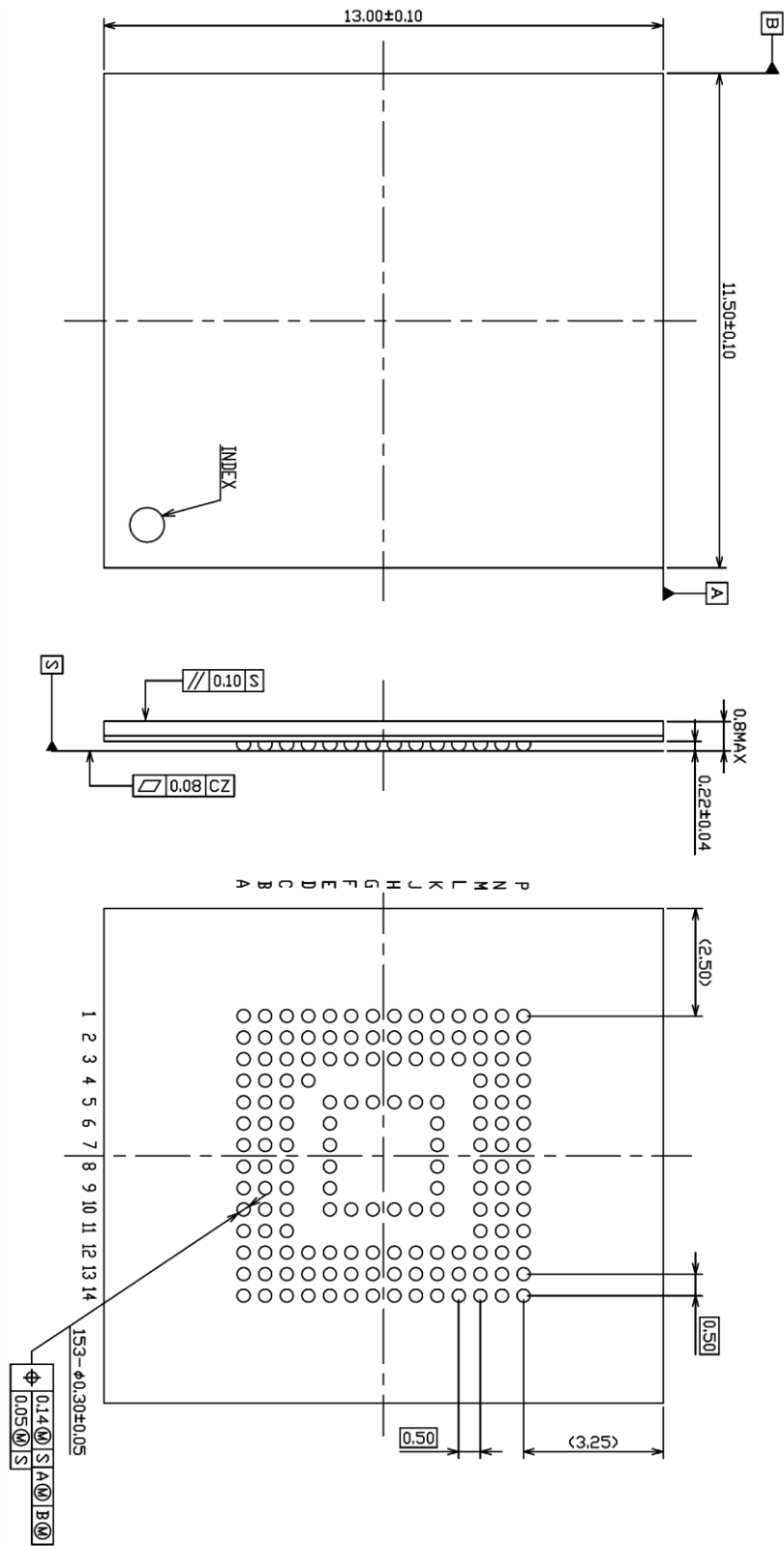

Density Specifications

Density	Part Number	Interleave Operation	User Area Density [Bytes]	SEC_COUNT in Extended CSD
8GB	THGBMFG6C1LBAIL	Non Interleave	7,818,182,656	0xE90000

1) User area density shall be reduced if enhanced user data area is defined.

Register Informations

OCR Register

OCR bit	VDD Voltage window	Value
[6:0]	Reserved	000 0000b
[7]	1.70-1.95	1b
[14:8]	2.0-2.6	000 0000b
[23:15]	2.7-3.6	1 1111 1111b
[28:24]	Reserved	0 0000b
[30:29]	Access Mode	10b
[31]	(card power up status bit (busy)) ¹	

1) This bit is set to LOW if the Device has not finished the power up routine.

CID Register

CID-slice	Name	Field	Width	Value
[127:120]	Manufacturer ID	MID	8	0001 0001b
[119:114]	Reserved	-	6	0b
[113:112]	Device/BGA	CBX	2	01b
[111:104]	OEM/Application ID	OID	8	0b
[103:56]	Product name	PNM	48	0x30 30 38 47 37 30 (008G70)
[55:48]	Product revision	PRV	8	0x00
[47:16]	Product serial	PSN	32	Serial number
[15:8]	Manufacturing date	MDT	8	see-JEDEC Specification
[7:1]	CRC7 checksum	CRC	7	CRC7
[0]	Not used, always '1'	-	1	1b

CSD Register

CSD-slice	Name	Field	Width	Cell Type	Value
[127:126]	CSD structure	CSD_STRUCTURE	2	R	0x3
[125:122]	System specification version	SPEC_VERS	4	R	0x4
[121:120]	Reserved	-	2	R	0x0
[119:112]	Data read access-time 1	TAAC	8	R	0x27
[111:104]	Data read access-time 2 in CLK cycles (NSAC * 100)	NSAC	8	R	0x00
[103:96]	Max. bus clock frequency	TRAN_SPEED	8	R	0x32
[95:84]	Device command classes	CCC	12	R	0x0F5
[83:80]	Max. read data block length	READ_BL_LEN	4	R	0x9
[79:79]	Partial blocks for read allowed	READ_BL_PARTIAL	1	R	0x0
[78:78]	Write block misalignment	WRITE_BLK_MISALIGN	1	R	0x0
[77:77]	Read block misalignment	READ_BLK_MISALIGN	1	R	0x0
[76:76]	DSR implemented	DSR_IMP	1	R	0x0
[75:74]	Reserved	-	2	R	0x0
[73:62]	Device size	C_SIZE	12	R	0xFFF
[61:59]	Max. read current @ VDD min.	VDD_R_CURR_MIN	3	R	0x7
[58:56]	Max. read current @ VDD max.	VDD_R_CURR_MAX	3	R	0x7
[55:53]	Max. write current @ VDD min.	VDD_W_CURR_MIN	3	R	0x7
[52:50]	Max. write current @ VDD max.	VDD_W_CURR_MAX	3	R	0x7
[49:47]	Device size multiplier	C_SIZE_MULT	3	R	0x7
[46:42]	Erase group size	ERASE_GRP_SIZE	5	R	0x1F
[41:37]	Erase group size multiplier	ERASE_GRP_MULT	5	R	0x1F
[36:32]	Write protect group size	WP_GRP_SIZE	5	R	0x07
[31:31]	Write protect group enable	WP_GRP_ENABLE	1	R	0x1
[30:29]	Manufacturer default ECC	DEFAULT_ECC	2	R	0x0
[28:26]	Write speed factor	R2W_FACTOR	3	R	0x1
[25:22]	Max. write data block length	WRITE_BL_LEN	4	R	0x9
[21:21]	Partial blocks for write allowed	WRITE_BL_PARTIAL	1	R	0x0
[20:17]	Reserved	-	4	R	0x0
[16:16]	Content protection application	CONTENT_PROT_APP	1	R	0x0
[15:15]	File format group	FILE_FORMAT_GRP	1	R/W	0x0
[14:14]	Copy flag (OTP)	COPY	1	R/W	0x0
[13:13]	Permanent write protection	PERM_WRITE_PROTECT	1	R/W	0x0
[12:12]	Temporary write protection	TMP_WRITE_PROTECT	1	R/W/E	0x0
[11:10]	File format	FILE_FORMAT	2	R/W	0x0
[9:8]	ECC code	ECC	2	R/W/E	0x0
[7:1]	CRC	CRC	7	R/W/E	CRC
[0]	Not used, always '1'	-	1	-	0x1

Extended CSD Register

CSD-slice	Name	Field	Size (Bytes)	Cell Type	Value
[511:506]	Reserved	-	6	-	All '0'
[505]	Extended Security Commands Error	EXT_SECURITY_ERR	1	R	0x00
[504]	Supported Command Sets	S_CMD_SET	1	R	0x01
[503]	HPI features	HPI_FEATURES	1	R	0x01
[502]	Background operations support	BKOPS_SUPPORT	1	R	0x01
[501]	Max_packed read commands	MAX_PACKED_READS	1	R	0x3F
[500]	Max_packed write commands	MAX_PACKED_WRITES	1	R	0x3F
[499]	Data Tag Support	DATA_TAG_SUPPORT	1	R	0x01
[498]	Tag Unit Size	TAG_UNIT_SIZE	1	R	0x03
[497]	Tag Resource Size	TAG_RES_SIZE	1	R	0x00
[496]	Context management capabilities	CONTEXT_CAPABILITIES	1	R	0x7F
[495]	Large Unit size	LARGE_UNIT_SIZE_M1	1	R	0x00
[494]	Extended partitions attribute support	EXT_SUPPORT	1	R	0x03
[493]	Supported modes	SUPPORTED_MODES	1	R	0x01
[492]	FFU features	FFU_FEATURES	1	R	0x00
[491]	Operation codes timeout	OPERATION_CODES_TIMEOUT	1	R	0x00
[490:487]	FFU Argument	FFU_ARG	4	R	0xFFFFFFFF
[486]	Barrier support	BARRIER_SUPPORT	1	R	0x01
[485:309]	Reserved	-	177	-	All '0'
[308]	CMD Queuing Support	CMDQ_SUPPORT	1	R	0x00
[307]	CMD Queuing Depth	CMDQ_DEPTH	1	R	0x00
[306]	Reserved	-	1	-	0x00
[305:302]	Number of FW sectors correctly programmed	NUMBER_OF_FW_SECTORS_CORRECTLY_PROGRAMMED	4	R	All '0'
[301:270]	Vendor proprietary health report	VENDOR_PROPRIETARY_HEALTH_REPORT	32	R	All '0'
[269]	Device life time estimation type B	DEVICE_LIFE_TIME_EST_TYP_B	1	R	0x00
[268]	Device life time estimation type A	DEVICE_LIFE_TIME_EST_TYP_A	1	R	0x01
[267]	Pre EOL information	PRE_EOL_INFO	1	R	0x01
[266]	Optimal read size	OPTIMAL_READ_SIZE	1	R	0x08
[265]	Optimal write size	OPTIMAL_WRITE_SIZE	1	R	0x08
[264]	Optimal trim unit size	OPTIMAL_TRIM_UNIT_SIZE	1	R	0x01
[263:262]	Device version	DEVICE_VERSION	2	R	0x00
[261:254]	Firmware version	FIRMWARE_VERSION	8	R	0x02
[253]	Power class for 200MHz, DDR at VCC=3.6V	PWR_CL_DDR_200_360	1	R	0xCC
[252:249]	Cache size	CACHE_SIZE	4	R	0x00001000
[248]	Generic CMD6 timeout	GENERIC_CMD6_TIME	1	R	0x0A
[247]	Power off notification(long) timeout	POWER_OFF_LONG_TIME	1	R	0x32
[246]	Background operations status	BKOPS_STATUS	1	R	0x00
[245:242]	Number of correctly programmed sectors	CORRECTLY_PRG_SECTORS_NUM	4	R	0x00000000
[241]	1 st initialization time after partitioning	INI_TIMEOUT_AP	1	R	0x1E

CSD-slice	Name	Field	Size (Bytes)	Cell Type	Value
[240]	Cache Flushing Policy	CACHE_FLUSH_POLICY	1	R	0x01
[239]	Power class for 52MHz, DDR @ 3.6V	PWR_CL_DDR_52_360	1	R	0x55
[238]	Power class for 52MHz, DDR @ 1.95V	PWR_CL_DDR_52_195	1	R	0xAA
[237]	Power class for 200MHz @ 3.6V	PWR_CL_200_360	1	R	0xBB
[236]	Power class for 200MHz @ 1.95V	PWR_CL_200_195	1	R	0xBB
[235]	Minimum Write Performance for 8bit @ 52MHz in DDR mode	MIN_PERF_DDR_W_8_52	1	R	0x00
[234]	Minimum Read Performance for 8bit @ 52MHz in DDR mode	MIN_PERF_DDR_R_8_52	1	R	0x64
[233]	Reserved	-	1	-	0x00
[232]	TRIM Multiplier	TRIM_MULT	1	R	0x01
[231]	Secure Feature support	SEC_FEATURE_SUPPORT	1	R	0x55
[230]	Secure Erase Multiplier	SEC_ERASE_MULT	1	R	0xFB
[229]	Secure TRIM Multiplier	SEC_TRIM_MULT	1	R	0xFF
[228]	Boot information	BOOT_INFO	1	R	0x07
[227]	Reserved	-	1	R	0x00
[226]	Boot partition size	BOOT_SIZE_MULT	1	R	0x20
[225]	Access size	ACC_SIZE	1	R	0x08
[224]	High-capacity erase unit size	HC_ERASE_GRP_SIZE	1	R	0x08
[223]	High-capacity erase timeout	ERASE_TIMEOUT_MULT	1	R	0x07
[222]	Reliable write sector count	REL_WR_SEC_C	1	R	0x01
[221]	High-capacity write protect group size	HC_WP_GRP_SIZE	1	R	0x01
[220]	Sleep current (Vcc)	S_C_VCC	1	R	0x07
[219]	Sleep current (VccQ)	S_C_VCCQ	1	R	0x09
[218]	Production state awareness timeout	PRODUCTION_STATE_AWARENESS_TIMEOUT	1	R	0x0A
[217]	Sleep/awake timeout	S_A_TIMEOUT	1	R	0x14
[216]	Sleep Notification Timeout	SLEEP_NOTIFICATION_TIME	1	R	0x10
[215:212]	Sector Count	SEC_COUNT	4	R	0x00E90000
[211]	Secure Write Protect Information	SECURE_WP_INFO	1	R	0x00
[210]	Minimum Write Performance for 8bit @ 52MHz	MIN_PERF_W_8_52	1	R	0x00
[209]	Minimum Read Performance 8bit @ 52MHz	MIN_PERF_R_8_52	1	R	0x78
[208]	Minimum Write Performance for 8bit @ 26MHz, for 4bit at 52MHz	MIN_PERF_W_8_26_4_52	1	R	0x00
[207]	Minimum Read Performance for 8bit @ 26MHz, for 4bit at 52MHz	MIN_PERF_R_8_26_4_52	1	R	0x46
[206]	Minimum Write Performance for 4bit @ 26MHz	MIN_PERF_W_4_26	1	R	0x00
[205]	Minimum Read Performance for 4bit @ 26MHz	MIN_PERF_R_4_26	1	R	0x1E

CSD-slice	Name	Field	Size (Bytes)	Cell Type	Value
[204]	Reserved	-	1	-	0x00
[203]	Power class for 26MHz @ 3.6V	PWR_CL_26_360	1	R	0x44
[202]	Power class for 52MHz @ 3.6V	PWR_CL_52_360	1	R	0x44
[201]	Power class for 26MHz @ 1.95V	PWR_CL_26_195	1	R	0xAA
[200]	Power class for 52MHz @ 1.95V	PWR_CL_52_195	1	R	0xAA
[199]	Partition switching timing	PARTITION_SWITCH_TIME	1	R	0x0A
[198]	Out-of-interrupt busy timing	OUT_OF_INTERRUPT_TIME	1	R	0x0A
[197]	I/O Driver Strength	DRIVER_STRENGTH	1	R	0x1F
[196]	Device Type	DEVICE_TYPE	1	R	0x57
[195]	Reserved	-	1	-	0x00
[194]	CSD structure version	CSD_STRUCTURE	1	R	0x02
[193]	Reserved	-	1	-	0x00
[192]	Extended CSD revision	EXT_CSD_REV	1	R	0x07
[191]	Command Set	CMD_SET	1	R/W/E_P	0x00
[190]	Reserved	-	1	-	0x00
[189]	Command set revision	CMD_SET_REV	1	R	0x00
[188]	Reserved	-	1	-	0x00
[187]	Power class ¹	POWER_CLASS	1	R/W/E_P	0x00
[186]	Reserved	-	1	-	0x00
[185]	High-speed interface timing	HS_TIMING	1	R/W/E_P	0x00
[184]	Strobe Support	STROBE_SUPPORT	1	R	0x01
[183]	Bus width mode	BUS_WIDTH	1	W/E_P	0x00
[182]	Reserved	-	1	-	0x00
[181]	Erased memory content	ERASED_MEM_CONT	1	R	0x00
[180]	Reserved	-	1	-	0x00
[179]	Partition configuration	PARTITION_CONFIG	1	R/W/E & R/W/E_P	0x00
[178]	Boot config protection	BOOT_CONFIG_PROT	1	R/W & R/W/C_P	0x00
[177]	Boot bus width	BOOT_BUS_WIDTH	1	R/W/E	0x00
[176]	Reserved	-	1	-	0x00
[175]	High-density erase group definition	ERASE_GROUP_DEF	1	R/W/E_P	0x00
[174]	Boot write protection status registers	BOOT_WP_STATUS	1	R	0x00
[173]	Boot area write protection register	BOOT_WP	1	R/W & R/W/C_P	0x00
[172]	Reserved	-	1	-	0x00
[171]	User area write protection register	USER_WP	1	R/W, R/W/C_P & R/W/E_P	0x00
[170]	Reserved	-	1	-	0x00
[169]	FW configuration	FW_CONFIG	1	R/W	0x00

CSD-slice	Name	Field	Size (Bytes)	Cell Type	Value
[168]	RPMB Size	RPMB_SIZE_MULT	1	R	0x20
[167]	Write reliability setting register	WR_REL_SET	1	R/W	0x1F
[166]	Write reliability parameter register	WR_REL_PARAM	1	R	0x15
[165]	Start Sanitize operation	SANITIZE_START	1	W/E_P	0x00
[164]	Manually start background operations	BKOPS_START	1	W/E_P	0x00
[163]	Enable background operations handshake	BKOPS_EN	1	R/W	0x00
[162]	H/W reset function	RST_n_FUNCTION	1	R/W	0x00
[161]	HPI management	HPI_MGMT	1	R/W/E_P	0x00
[160]	Partitioning Support	PARTITIONING_SUPPORT	1	R	0x07
[159:157]	Max Enhanced Area Size ²	MAX_ENH_SIZE_MULT	3	R	0x0003A4
[156]	Partitions attribute	PARTITIONS_ATTRIBUTE	1	R/W	0x00
[155]	Partitioning Setting	PARTITION_SETTING_COMPLETED	1	R/W	0x00
[154:143]	General Purpose Partition Size ³	GP_SIZE_MULT	12	R/W	0x00
[142:140]	Enhanced User Data Area Size ⁴	ENH_SIZE_MULT	3	R/W	0x00
[139:136]	Enhanced User Data Start Address	ENH_START_ADDR	4	R/W	0x00
[135]	Reserved	-	1	-	0x00
[134]	Bad Block Management mode	SEC_BAD_BLK_MGMNT	1	R/W	0x00
[133]	Production state awareness ⁶	PRODUCTION_STATE_AWARENESS	1	R/W/E	0x00
[132]	Package Case Temperature is controlled ¹	TCASE_SUPPORT	1	W/E_P	0x00
[131]	Periodic Wake-up ¹	PERIODIC_WAKEUP	1	R/W/E	0x00
[130]	Program CID/CSD in DDR mode support	PROGRAM_CID_CSD_DDR_SUPPORT	1	R	0x01
[129:128]	Reserved	-	2	-	All '0'
[127:64]	Vendor Specific Fields	VENDOR_SPECIFIC_FIELD	1	-	-
[63]	Native sector size	NATIVE_SECTOR_SIZE	1	R	0x01
[62]	Sector size emulation	USE_NATIVE_SECTOR	1	R/W	0x00
[61]	Sector size	DATA_SECTOR_SIZE	1	R	0x00
[60]	1st initialization after disabling sector size emulation	INI_TIMEOUT_EMU	1	R	0x0A
[59]	Class 6 commands control	CLASS_6_CTRL	1	R/W/E_P	0x00
[58]	Number of addressed group to be Released	DYNCAP_NEEDED	1	R	0x00
[57:56]	Exception events control	EXCEPTION_EVENTS_CTRL	2	R/W/E_P	0x00
[55:54]	Exception events status	EXCEPTION_EVENTS_STATUS	2	R	All '0'
[53:52]	Extended partitions attribute ¹	EXT_PARTITIONS_ATTRIBUTE	2	R/W	0x00
[51:37]	Context configuration	CONTEXT_CONF	15	R/W/E_P	0x00
[36]	Packed command status	PACKED_COMMAND_STATUS	1	R	0x00
[35]	Packed command failure index	PACKED_FAILURE_INDEX	1	R	0x00
[34]	Power Off Notification ⁵	POWER_OFF_NOTIFICATION	1	R/W/E_P	0x00
[33]	Control to turn the Cache ON/OFF	CACHE_CTRL	1	R/W/E_P	0x00

CSD-slice	Name	Field	Size (Bytes)	Cell Type	Value
[32]	Flushing of the cache	FLUSH_CACHE	1	W/E_P	0x00
[31]	Control to turn the Barrier ON/OFF	BARRIER_CTRL	1	R/W	0x00
[30]	Mode config	MODE_CONFIG	1	R/W/E_P	0x00
[29]	Mode operation codes	MODE_OPERATION_CODES	1	W/E_P	0x00(not support. Return switch error)
[28:27]	Reserved	-	2	R	All '0'
[26]	FFU status	FFU_STATUS	1	R	0x00
[25:22]	Pre loading data size ⁶	PRE_LOADING_DATA_SIZE	4	R/W/E_P	0x00576000
[21:18]	Max pre loading data size	MAX_PRE_LOADING_DATA_SIZE	4	R	0x00576000
[17]	Product state awareness enablement ⁵	PRODUCT_STATE_AWARENESS_ENABLEMENT	1	R/W/E & R	0x03
[16]	Secure Removal Type	SECURE_REMOVAL_TYPE	1	R/W & R	0x39
[15]	Command Queue Mode Enable	CMDQ_MODE_EN	1	R/W/E_P	0x00
[14:0]	Reserved	-	15	-	All '0'

¹ Although these fields can be re-written by host, TOSHIBA e-MMC does not support.

² Max Enhanced Area Size (MAX_ENH_SIZE_MULT [159:157]) has to be calculated by following formula.

Max Enhanced Area = MAX_ENH_SIZE_MULT x HC_WP_GRP_SIZE x HC_ERASE_GRP_SIZE x 512kBytes

$$\sum_{i=1}^4 \text{Enhanced general partition size}(i) + \text{Enhanced user data area} \leq \text{Max enhanced area}$$

³ General Purpose Partition Size (GP_SIZE_MULT_GP0 - GP_SIZE_MULT_GP3 [154:143]) has to be calculated by following formula.

$$\text{General Purpose Partition X Size} = (\text{GP_SIZE_MULT_X_2} \times 2^{16} + \text{GP_SIZE_MULT_X_1} \times 2^8 + \text{GP_SIZE_MULT_X_0} \times 2^0) \times \text{HC_WP_GRP_SIZE} \times \text{HC_ERASE_GRP_SIZE} \times 512\text{kBytes}$$

⁴ Enhanced User Data Area Size (ENH_SIZE_MULT [142:140]) has to be calculated by following formula.

$$\text{Enhanced User Data Area x Size} = (\text{ENH_SIZE_MULT_2} \times 2^{16} + \text{ENH_SIZE_MULT_1} \times 2^8 + \text{ENH_SIZE_MULT_0} \times 2^0) \times \text{HC_WP_GRP_SIZE} \times \text{HC_ERASE_GRP_SIZE} \times 512\text{kBytes}$$

⁵ Toshiba recommends to issue the Power Off Notification before turning off the device, especially when cache is on or AUTO_EN(BKOPS_EN[163]:bit1) is set to '1b'.

- ⁶ - Pre loading data size = PRE_LOADING_DATA_SIZE x Sector Size
Pre-loading data size should be multiple of 4KB and the pre-loading data should be written by multiple of 4KB chunk size, aligned with 4KB address. This is because the valid data size will be treated as 4KB when host writes data less than 4KB.
- If the host continues to write data in Normal state (after it wrote PRE_LOADING_DATA_SIZE amount of data) and before soldering, the pre-loading data might be corrupted after soldering.
 - If a power cycle is occurred during the data transfer, the amount of data written to device is not clear. Therefore in this case, host should erase the entire pre-loaded data and set again PRE_LOADING_DATA_SIZE[25:22], PRODUCTION_STATE_AWARENESS[133], and PRODUCT_STATE_AWARENESS_ENABLEMENT[17].

ELECTRICAL CHARACTERISTICS

DC Characteristics

Absolute Maximum Ratings

The absolute maximum ratings of a semiconductor device are a set of specified parameter values, which must not be exceeded during operation, even for an instant.

If any of these rating would be exceeded during operation, the device electrical characteristics may be irreparably altered and the reliability and lifetime of the device can no longer be guaranteed. Moreover, these operations with exceeded ratings may cause break down, damage, and/or degradation to any other equipment. Applications using the device should be designed such that each maximum rating will never be exceeded in any operating conditions.

Before using, creating, and/or producing designs, refer to and comply with the precautions and conditions set forth in this document.

Parameter	Symbol	Test Conditions	Min	Max	Unit
Supply voltage 1	V _{CC}		-0.5	4.1	V
Supply voltage 2	V _{CCQ}		-0.5	4.1	V
Voltage Input	V _{IO}		-0.5	V _{CCQ} +0.5(≤4.1)	V

General

Parameter	Symbol	Test Conditions	Min	Max	Unit
Peak voltage on all lines			-0.5	V _{CCQ} +0.5	V
All Inputs					
Input Leakage Current (before initialization sequence ¹ and/or the internal pull up resistors connected)			-100	100	μA
Input Leakage Current (after initialization sequence and the internal pull up resistors disconnected)			-2	2	μA
All Outputs					
Output Leakage Current (before initialization sequence)			-100	100	μA
Output Leakage Current (after initialization sequence)			-2	2	μA

1) Initialization sequence is defined in Power-Up chapter of JEDEC/MMCA Standard

Power Supply Voltage

Parameter	Symbol	Test Conditions	Min	Max	Unit
Supply voltage 1	V _{CC}		2.7	3.6	V
Supply voltage 2	V _{CCQ}		1.7	1.95	V
			2.7	3.6	V

1) Once the power supply V_{CC} or V_{CCQ} falls below the minimum guaranteed voltage (for example, upon sudden power fail), the voltage level of V_{CC} or V_{CCQ} shall be kept less than 0.5 V for at least 1ms before it goes beyond 0.5 V again.

Supply Current

Parameter		Symbol	Interleave Operation	Mode	VccQ	Min		Max		Unit
						Iccq	Icc	Iccq	Icc	
Operation (RMS)	Read	I _{ROP}	Non Interleave	SDR	1.8V	—	—	95	15	mA
					3.3V	—	—	110	15	
				DDR	1.8V	—	—	120	20	mA
					3.3V	—	—	140	20	
	HS200	1.8V	—	—	175	30	mA			
		HS400	1.8V	—	—	220		40		
	Write	I _{WOP}	Non Interleave	SDR	1.8V	—	—	65	40	mA
					3.3V	—	—	65	40	
				DDR	1.8V	—	—	65	40	mA
					3.3V	—	—	65	40	
HS200				1.8V	—	—	65	40	mA	
HS400				1.8V	—	—	70	40		

Internal resistance and Device capacitance

Parameter	Symbol	Test Conditions	Min	Max	Unit
Single device capacitance	C _{DEVICE}		—	6	pF
Internal pull up resistance DAT1 – DAT7	R _{INT}		10	150	KΩ

Bus Signal Levels

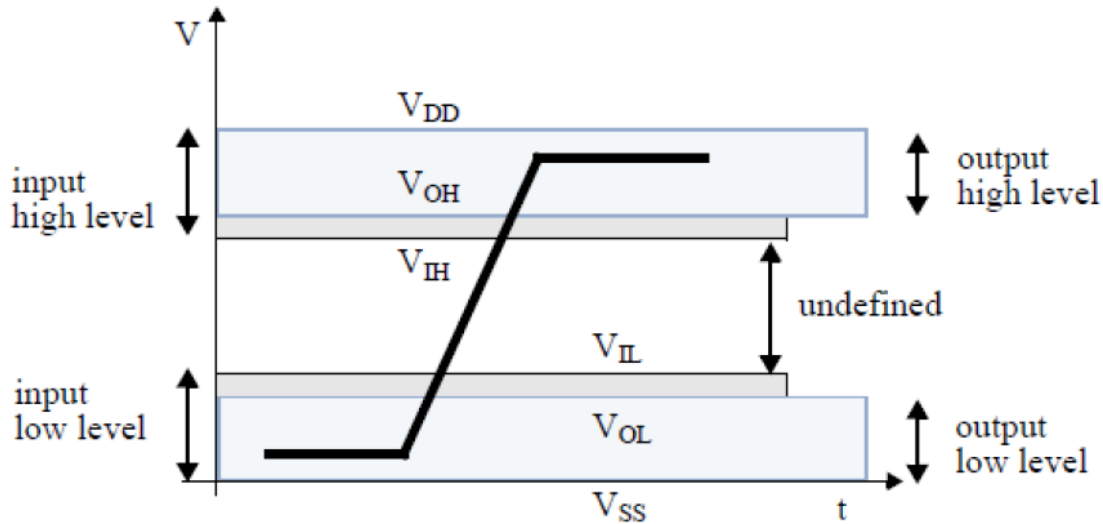

Open-Drain Mode Bus Signal Level

Parameter	Symbol	Test Conditions	Min	Max	Unit
Output HIGH voltage	V _{OH}	I _{OH} = -100μA	V _{CCQ} - 0.2	—	V
Output LOW voltage	V _{OL}	I _{OL} = 2mA	—	0.3	V

Push-Pull Mode Bus Signal Level (High-Voltage)

Parameter	Symbol	Test Conditions	Min	Max	Unit
Output HIGH voltage	V _{OH}	I _{OH} = -100μA @ V _{DD} min	0.75 * V _{CCQ}	—	V
Output LOW voltage	V _{OL}	I _{OL} = 100μA @ V _{DD} min	—	0.125 * V _{CCQ}	V
Input HIGH voltage	V _{IH}		0.625 * V _{CCQ}	V _{CCQ} + 0.3	V
Input LOW voltage	V _{IL}		V _{SS} - 0.3	0.25 * V _{CCQ}	V

Push-Pull Mode Bus Signal Level (Dual-Voltage)

Parameter	Symbol	Test Conditions	Min	Max	Unit
Output HIGH voltage	V _{OH}	I _{OH} = -2mA @ V _{DD} min	V _{CCQ} - 0.45	—	V
Output LOW voltage	V _{OL}	I _{OL} = 2mA @ V _{DD} min	—	0.45	V
Input HIGH voltage	V _{IH}		0.65 * V _{CCQ}	V _{CCQ} + 0.3	V
Input LOW voltage	V _{IL}		V _{SS} - 0.3	0.35 * V _{CCQ}	V

Driver Types Definition

Driver Type-0 is defined as mandatory for e-MMC HS200&HS400 Device. While four additional Driver Types (1, 2, 3 and 4) are defined as optional, to allow the support of wider Host loads. The Host may select the most appropriate Driver Type of the Device (if supported) to achieve optimal signal integrity performance.

Driver Type-0 is targeted for transmission line, based distributed system with 50Ω nominal line impedance. Therefore, it is defined as 50Ω nominal driver.

For HS200, when tested with $C_L = 15pF$ Driver Type-0 shall meet all AC characteristics and HS200 Device output timing requirements. The test circuit defined in section 10.5.4.3 of JEDEC/MMCA Standard 5.0 is used for testing of Driver Type-0.

For HS400, when tested with the reference load defined in page 24 HS400 reference load figure, Driver Type-0 or Driver Type-1 or Driver-4 shall meet all AC characteristics and HS400 Device output timing requirements.

The Optional Driver Types are defined with reference to Driver Type-0.

Driver Type	HS200 & HS400 Support	TOSHIBA e-MMC	Normal Impedance	Approximated driving capability compared to Type-0	Remark
0	Mandatory	Supported	50 Ω	x1	Default Driver Type.Supports up to 200MHz operation.
1	Optional	Supported	33 Ω	x1.5	Supports up to 200MHz operation.
2	Optional	Supported	66 Ω	x0.75	The weakest driver that supports up to 200MHz operation.
3	Optional	Supported	100 Ω	x0.5	For low noise and low EMI systems. Maximal operating frequency is decided by Host design.
4	Optional	Supported	40 Ω	X1.2	

1) Support of Driver Type-0 is mandatory for HS200&HS400 Device, while supporting Driver types 1, 2 and 3 is optional for HS200 and Driver type 4 is optional for HS400 Device.

2) Nominal impedance is defined by I-V characteristics of output driver at 0.9V when $V_{CCQ} = 1.8V$.

***Toshiba recommends Driver Type Value 0x4 in HS400 mode.**

In particular, Driver Type Value 0x1 or 0x4 in HS400 mode is strongly recommended under the condition of JEDEC standard reference load. Please select the most suitable setting for users' operating environment.

Bus Timing

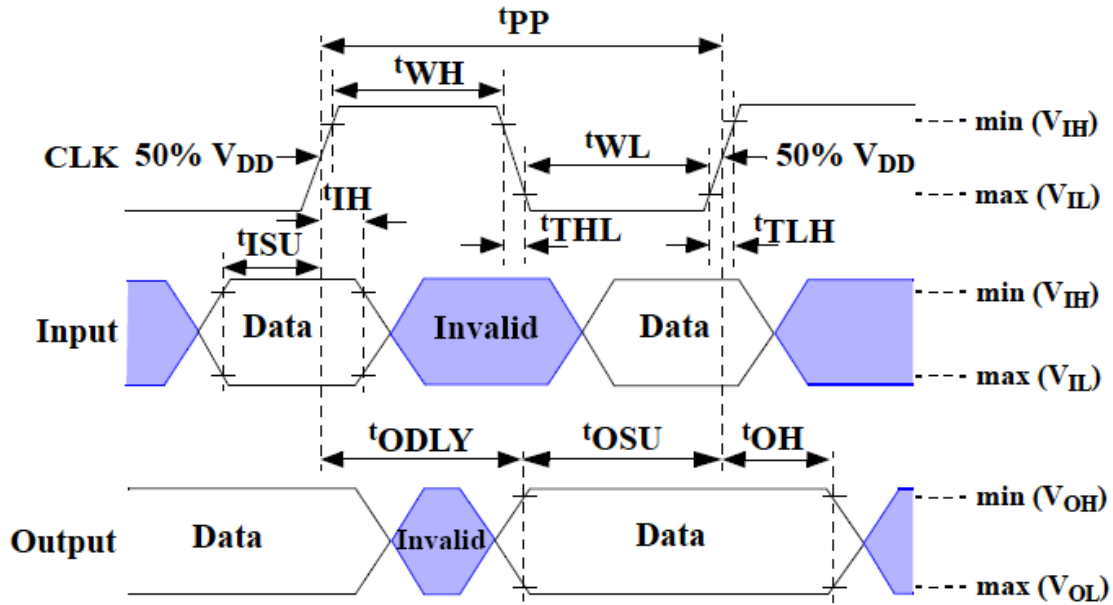

Data must always be sampled on the rising edge of the clock.

Device Interface Timings (High-speed interface timing)

Parameter	Symbol	Test Conditions	Min	Max	Unit
Clock frequency Data Transfer Mode (PP) ²	f_{pp}	$C_L \leq 30\text{pF}$ Tolerance: +100KHz	0	52 ³	MHz
Clock frequency Identification Mode (OD)	f_{OD}	Tolerance: +20KHz	0	400	KHz
Clock high time	t_{WH}	$C_L \leq 30\text{pF}$	6.5	—	ns
Clock low time	t_{WL}	$C_L \leq 30\text{pF}$	6.5	—	ns
Clock rise time ⁴	t_{TLH}	$C_L \leq 30\text{pF}$	—	3	ns
Clock fall time	t_{THL}	$C_L \leq 30\text{pF}$	—	3	ns
Inputs CMD,DAT (referenced to CLK)					
Input set-up time	t_{ISU}	$C_L \leq 30\text{pF}$	3	—	ns
Input hold time	t_{IH}	$C_L \leq 30\text{pF}$	3	—	ns
Outputs CMD,DAT (referenced to CLK)					
Output Delay time during Data Transfer	t_{ODLY}	$C_L \leq 30\text{pF}$	—	13.7	ns
Output hold time	t_{OH}	$C_L \leq 30\text{pF}$	2.5	—	ns
Signal rise time ⁵	t_{rise}	$C_L \leq 30\text{pF}$	—	3	ns
Signal fall time	t_{fall}	$C_L \leq 30\text{pF}$	—	3	ns

- 1) CLK timing is measured at 50% of V_{ccQ}
- 2) This product shall support the full frequency range from 0-26MHz, or 0-52MHz
- 3) e-MMC can operate as high-speed interface timing at 26MHz clock frequency.
- 4) CLK rise and fall times are measured by $\min(V_{IH})$ and $\max(V_{IL})$.
- 5) Inputs CMD,DAT rise and fall times are measured by $\min(V_{IH})$ and $\max(V_{IL})$, and outputs CMD, DAT rise and fall times are measured by $\min(V_{OH})$ and $\max(V_{OL})$.

Device Interface Timings (Backward-compatible interface timing)

Parameter	Symbol	Test Conditions	Min	Max	Unit
Clock frequency Data Transfer Mode (PP) ³	f _{pp}	C _L ≤ 30pF	0	26	MHz
Clock frequency Identification Mode (OD)	f _{OD}	Tolerance: +20KHz	0	400	KHz
Clock high time	t _{WH}	C _L ≤ 30pF	10	—	ns
Clock low time	t _{WL}	C _L ≤ 30pF	10	—	ns
Clock rise time ⁴	t _{TLH}	C _L ≤ 30pF	—	10	ns
Clock fall time	t _{THL}	C _L ≤ 30pF	—	10	ns
Inputs CMD,DAT (referenced to CLK)					
Input set-up time	t _{ISU}	C _L ≤ 30pF	3	—	ns
Input hold time	t _{IH}	C _L ≤ 30pF	3	—	ns
Outputs CMD,DAT (referenced to CLK)					
Output set-up time ⁵	t _{OSU}	C _L ≤ 30pF	11.7	—	ns
Output hold time ⁵	t _{OH}	C _L ≤ 30pF	8.3	—	ns

- 1) The e-MMC must always start with the backward-compatible interface timing. The timing mode can be switched to high-speed interface timing by the host sending the SWITCH command (CMD6) with the argument for high-speed interface select.
 - 2) CLK timing is measured at 50% of V_{ccQ}
 - 3) For compatibility with e-MMCs that support the v4.2 standard or earlier, host should not use >26MHz before switching to high-speed interface timing.
 - 4) CLK rise and fall times are measured by min(V_{IH}) and max(V_{IL}).
 - 5) t_{OSU} and t_{OH} are defined as values from clock rising edge. However, the e-MMC device will utilize clock falling edge to output data in backward compatibility mode. Therefore, it is recommended for hosts either to set t_{WL} value as long as possible within the range which will not go over t_{CK} - t_{OH}(min) in the system or to use slow clock frequency, so that host could have data set up margin for the device.
- Toshiba e-MMC device utilize clock falling edge to output data in backward compatibility mode.
Host should optimize the timing in order to have data set up margin as follows.

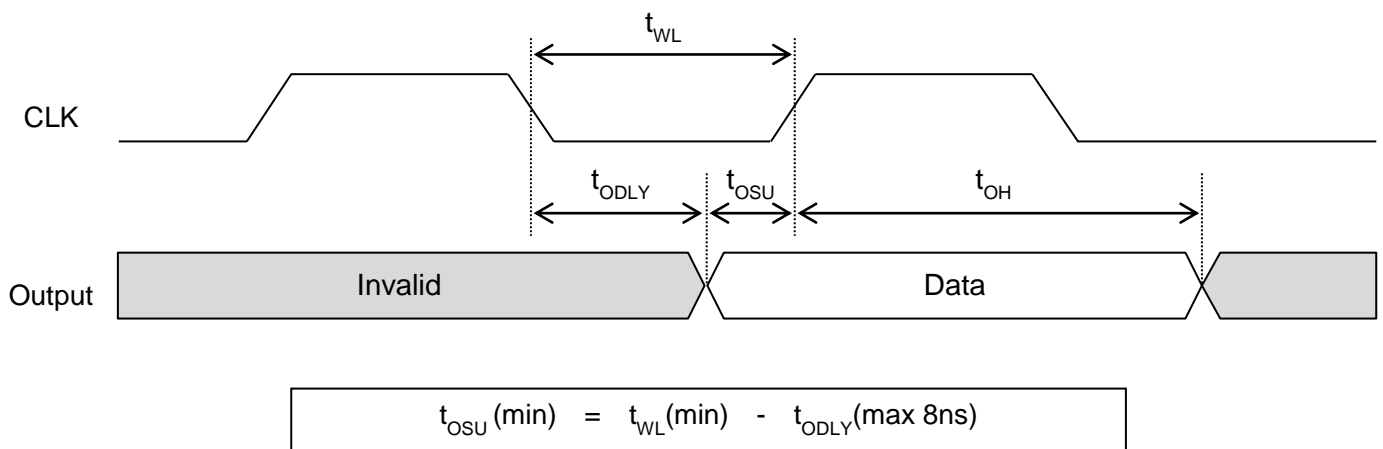
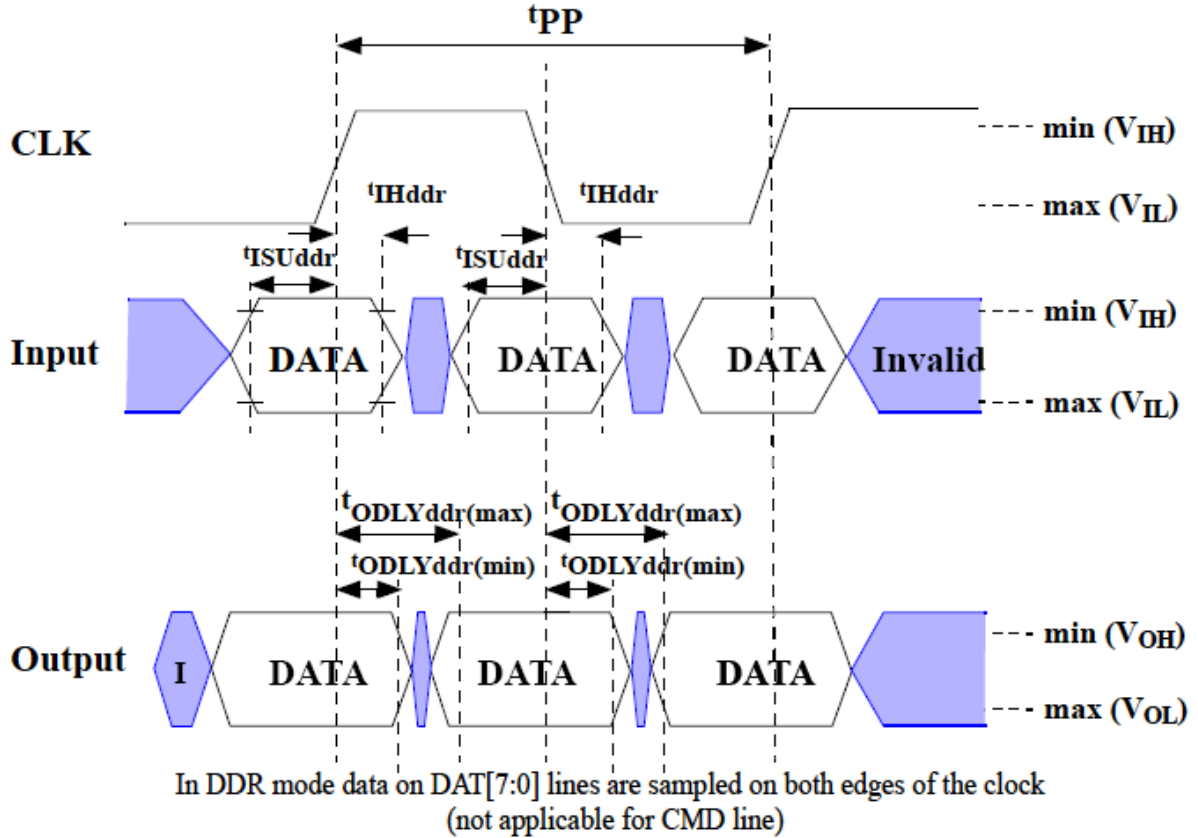

Figure 2 Output timing

Bus Timing for DAT signals for during 2x data rate operation

These timings applies to the DAT[7:0] signals only when the device is configured for dual data mode operation. In this dual data mode, the DAT signals operates synchronously of both the rising and the falling edges of CLK. the CMD signal still operates synchronously of the rising edge of CLK and therefore complies with the bus timing specified in High-speed interface timing or Backward-compatible interface timing.



High-speed dual data rate interface timings

Parameter	Symbol	Min	Max	Unit	Remark ¹
Input CLK ¹					
Clock duty cycle		45	55	%	Includes jitter, phase noise
Clock rise time	t _{TLH}		3	ns	CL ≤ 30pF
Clock fall time	t _{THL}		3	ns	CL ≤ 30pF
Input CMD(referenced to CLK-SDR mode)					
Input set-up time	t _{SUddr}	3		ns	CL ≤ 20pF
Input hold time	t _{Hddr}	3		ns	CL ≤ 20pF
Output CMD(referenced to CLK-SDR mode)					
Output delay time during data transfer	t _{ODLY}		13.7	ns	CL ≤ 20pF
Output hold time	t _{OH}	2.5		ns	CL ≤ 20pF
Signal rise time	t _{RISE}		3	ns	CL ≤ 20pF
Signal fall time	t _{FALL}		3	ns	CL ≤ 20pF

Parameter	Symbol	Min	Max	Unit	Remark ¹
Input DAT (referenced to CLK-DDR mode)					
Input set-up time	t _{ISUddr}	2.5	—	ns	CL ≤ 20pF
Input hold time	t _{IHddr}	2.5	—	ns	CL ≤ 20pF
Output DAT (referenced to CLK-DDR mode)					
Output delay time during data transfer	t _{ODLYddr}	1.5	7	ns	CL ≤ 20pF
Signal rise time (all signals) ²	t _{RISE}	—	2	ns	CL ≤ 20pF
Signal fall time (all signals)	t _{FALL}	—	2	ns	CL ≤ 20pF

1) CLK timing is measured at 50% of V_{ccQ}.

2) Inputs CMD, DAT rise and fall times are measured by min (V_{IH}) and max (V_{IL}), and outputs CMD, DAT rise and fall times are measured by min (V_{OH}) and max (V_{OL}).

Bus Timing Specification in HS200 mode

HS200 Clock Timing

Host CLK Timing in HS200 mode shall conform to the timing specified in following figure and Table. CLK input shall satisfy the clock timing over all possible operation and environment conditions. CLK input parameters should be measured while CMD and DAT lines are stable high or low, as close as possible to the Device. The maximum frequency of HS200 is 200MHz. Hosts can use any frequency up to the maximum that HS200 mode allows.

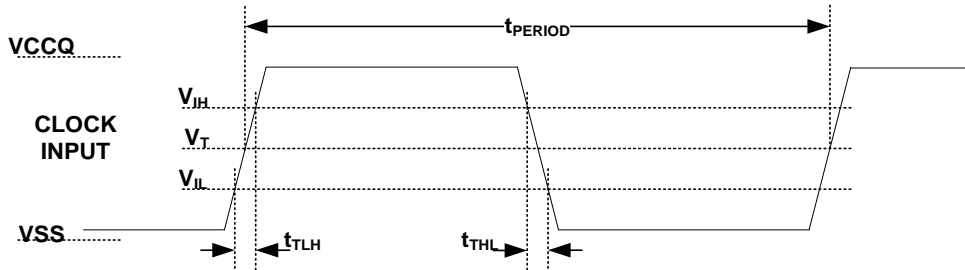

NOTE 1 VIH denote VIH(min.) and VIL denotes VIL(max.).

NOTE 2 VT=0.975V - Clock Threshold, indicates clock reference point for timing measurements.

Symbol	Min	Max	Unit	Remark
t _{PERIOD}	5	—	ns	200MHz (Max.), between rising edges
t _{TLH} , t _{THL}	—	0.2 * t _{PERIOD}	ns	t _{TLH} , t _{THL} < 1ns (max.) at 200MHz, C _{DEVICE} =6pF, The absolute maximum value of t _{TLH} , t _{THL} is 10ns regardless of clock frequency.
Duty Cycle	30	70	%	

HS200 Device Input Timing

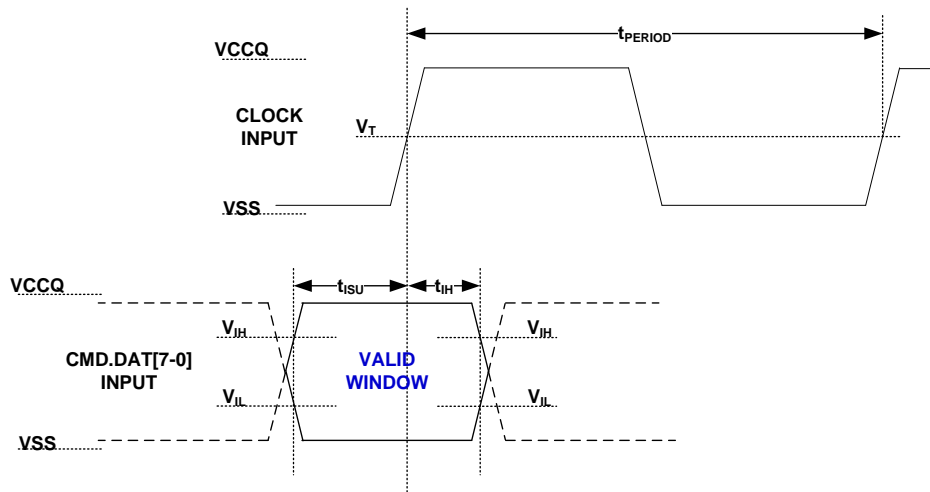

NOTE 1 t_{ISU} and t_{IH} are measured at VIL(max.) and VIH(min.).

NOTE 2 VIH denote VIH(min.) and VIL denotes VIL(max.).

Symbol	Min	Max	Unit	Remark
t _{ISU}	1.40	—	ns	C _{DEVICE} ≤ 6pF
t _{IH}	0.8	—	ns	C _{DEVICE} ≤ 6pF

HS200 Device Output Timing

t_{PH} parameter is defined to allow device output delay to be longer than t_{PERIOD} . After initialization, the t_{PH} may have random phase relation to the clock. The Host is responsible to find the optimal sampling point for the Device outputs, while switching to the HS200 mode.

While setting the sampling point of data, a long term drift, which mainly depends on temperature drift, should be considered. The temperature drift is expressed by ΔT_{PH} . Output valid data window (t_{VW}) is available regardless of the drift (ΔT_{PH}) but position of data window varies by the drift.

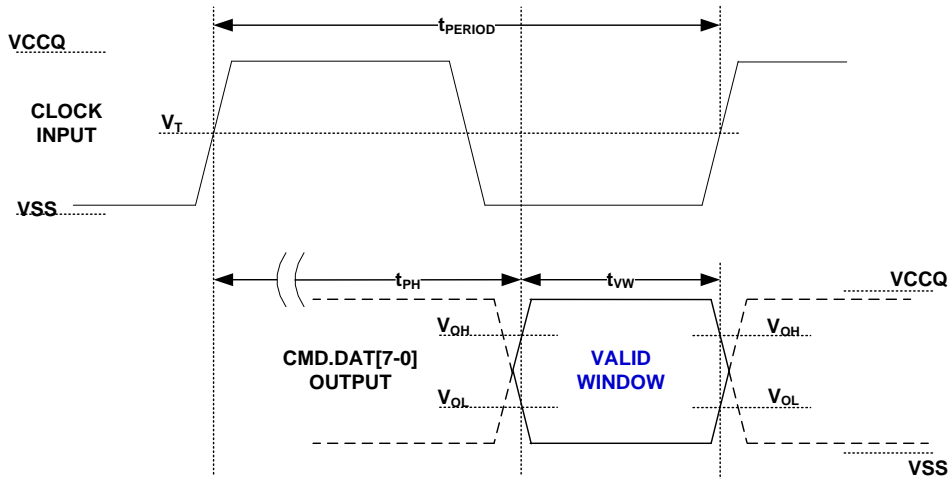

NOTE V_{OH} denotes $V_{OH}(\min.)$ and V_{OL} denotes $V_{OL}(\max.)$.

Symbol	Min	Max	Unit	Remark ¹
t_{PH}	0	2	UI	Device output momentary phase from CLK input to CMD or DAT lines output. Does not include a long term temperature drift.
ΔT_{PH}	-350 ($\Delta T = -20\text{ }^\circ\text{C}$)	+1550 ($\Delta T = 90\text{ }^\circ\text{C}$)	ps	Delay variation due to temperature change after tuning. Total allowable shift of output valid window (T_{VW}) from last system Tuning procedure ΔT_{PH} is 2600ps for ΔT from $-25\text{ }^\circ\text{C}$ to $125\text{ }^\circ\text{C}$ during operation.
t_{VW}	0.575	—	UI	$t_{VW} \approx 2.88\text{ns}$ at 200MHz Using test circuit in following figure including skew among CMD and DAT lines created by the Device. Host path may add Signal Integrity induced noise, skews, etc. Expected t_{VW} at Host input is larger than 0.475UI.

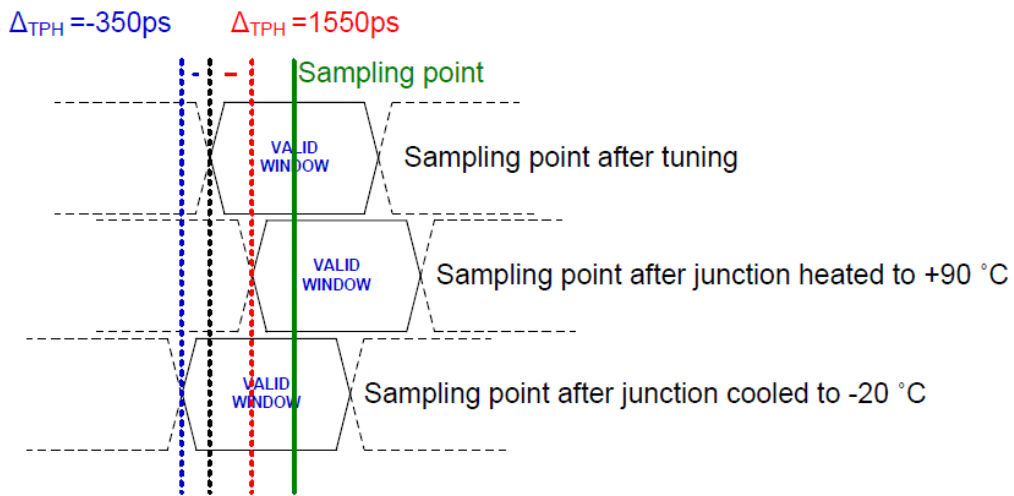
Δ_{TPH} consideration**Implementation Guide:**

Host should design to avoid sampling errors that may be caused by the Δ_{TPH} drift.
It is recommended to perform tuning procedure while Device wakes up, after sleep.
One simple way to overcome the Δ_{TPH} drift is by reduction of operating frequency.

Bus Timing Specification in HS400 mode

HS400 Input Timing

The CMD input timing for HS400 mode is the same as CMD input timing for HS200 mode.

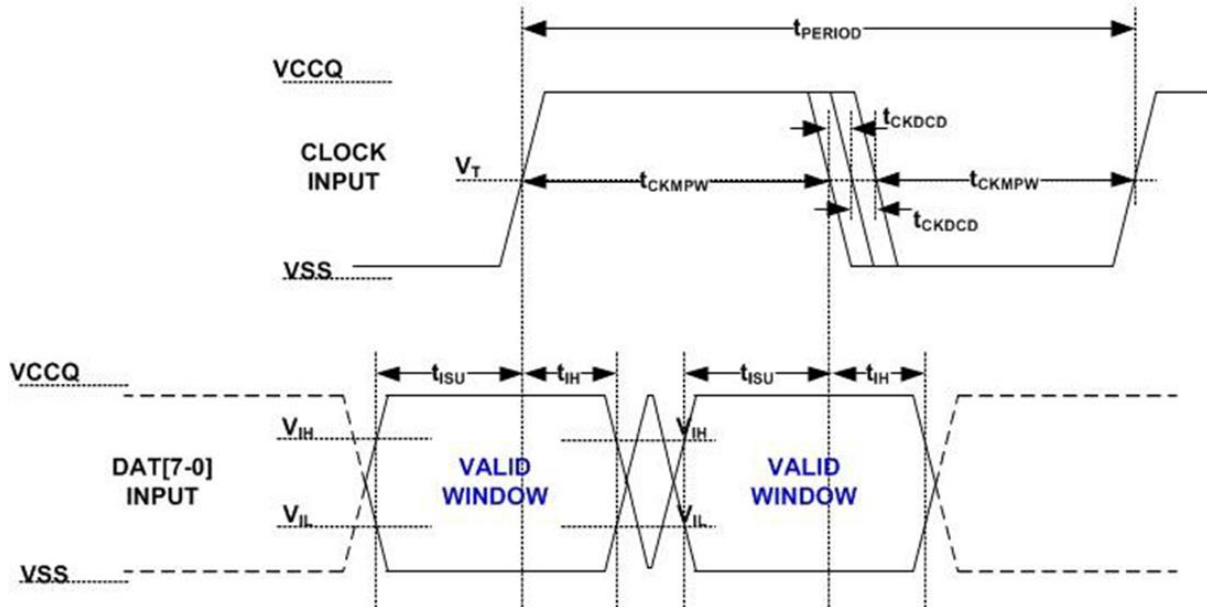

Note : VIH denote VIH(min) and VIL denotes VIL(max)

Parameter	Symbol	Min	Max	Unit	Remark
Input CLK					
Cycle time data transfer mode	t _{PERIOD}	5		ns	200MHz(Max), between rising edges With respect to VT
Slew rate	SR	1.125		V/ns	With respect to VIH/VIL
Duty cycle distortion	t _{CKDCCD}	0.0	0.3	ns	Allowable deviation from an ideal 50% duty cycle. With respect to VT Includes jitter, phase noise
Minimum pulse width	t _{CKMPW}	2.2		ns	With respect to VT
Input DAT(referenced to CLK)					
Input set-up time	t _{ISUddr}	0.4		ns	C _{Device} ≤ 6pF With respect to VIH/VIL
Input hold time	t _{IHddr}	0.4		ns	C _{Device} ≤ 6pF With respect to VIH/VIL
Slew rate	SR	1.125		V/ns	With respect to VIH/VIL

HS400 Device Output Timing

The Data Strobe is used to read data in HS400 mode. The Data Strobe is toggled only during data read or CRC status response.

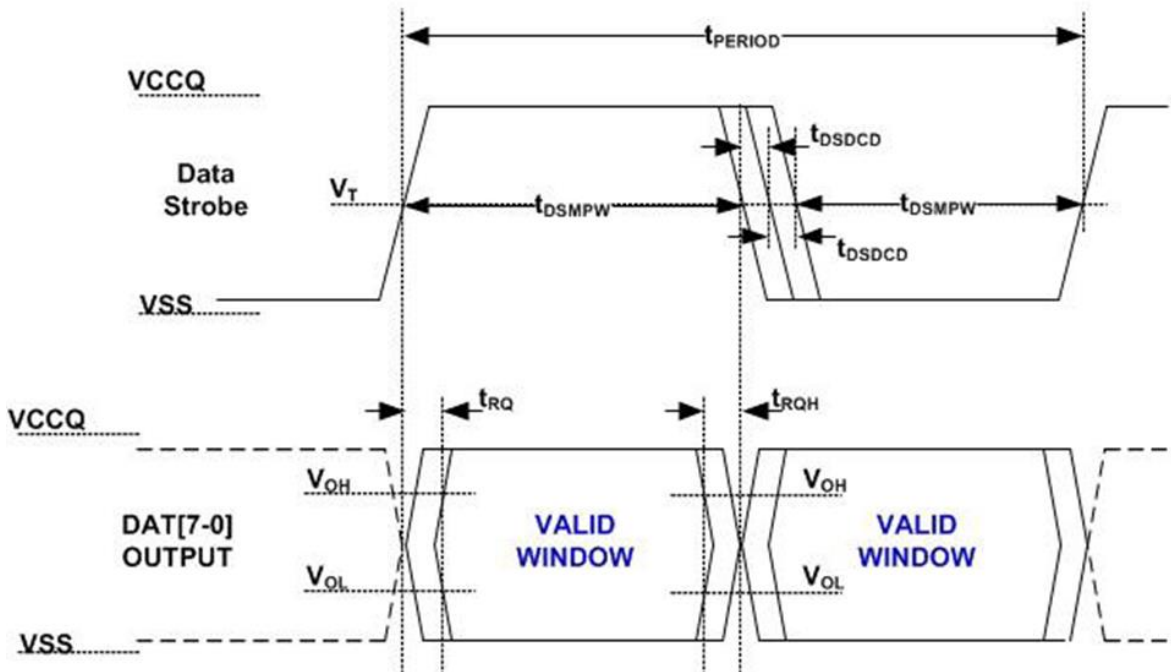

Note : V_{OH} denotes $V_{OH(min)}$ and V_{OL} denotes $V_{OL(max)}$

Parameter	Symbol	Min	Max	Unit	Remark
Data Strobe					
Cycle time data transfer mode	t_{PERIOD}	5		ns	200MHz(Max), between rising edges With respect to V_T
Slew rate	SR	1.125		V/ns	With respect to V_{OH}/V_{OL} and HS400 reference load
Duty cycle distortion	t_{DSDCD}	0.0	0.2	ns	Allowable deviation from the input CLK duty cycle distortion(t_{CKDCD}) With respect to V_T Includes jitter, phase noise
Minimum pulse width	t_{DSMPW}	2.0		ns	With respect to V_T
Output DAT(referenced to Data Strobe)					
Output skew	t_{RQ}		0.4	ns	With respect to V_{OH}/V_{OL} and HS400 reference load
Output hold skew	t_{RQH}		0.4	ns	With respect to V_{OH}/V_{OL} and HS400 reference load
Slew rate	SR	1.125		V/ns	With respect to V_{OH}/V_{OL} and HS400 reference load

HS400 Device Command Output Timing

The Data Strobe is used to response of any command in HS400 mode.

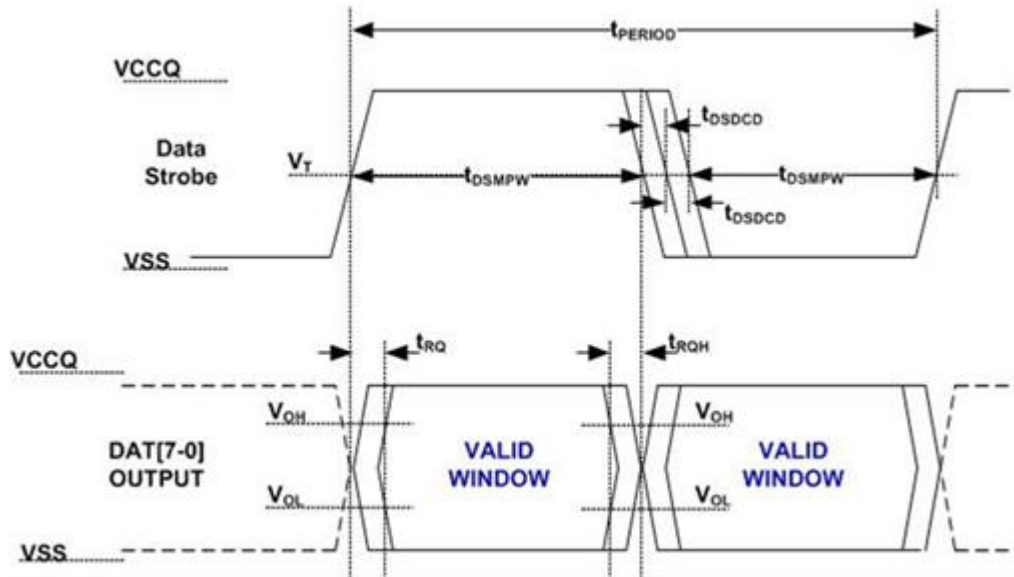

Note : V_{OH} denotes $V_{OH(min)}$ and V_{OL} denotes $V_{OL(max)}$

Parameter	Symbol	Min	Max	Unit	Remark
Data Strobe					
Cycle time data transfer mode	t_{PERIOD}	5		ns	200MHz(Max), between rising edges With respect to V_T
Slew rate	SR	1.125		V/ns	With respect to V_{OH}/V_{OL} and HS400 reference load
Duty cycle distortion	t_{DSDCD}	0.0	0.2	ns	Allowable deviation from the input CLK duty cycle distortion(t_{CKDCD}) With respect to V_T Includes jitter, phase noise
Minimum pulse width	t_{DSMPW}	2.0		ns	With respect to V_T
CMD Response (referenced to Data Strobe)					
Output skew(CMD)	t_{RQ_CMD}		0.4	ns	With respect to V_{OH}/V_{OL} and HS400 reference load
Output hold skew(CMD)	t_{RQH_CMD}		0.4	ns	With respect to V_{OH}/V_{OL} and HS400 reference load
Slew rate	SR	1.125		V/ns	With respect to V_{OH}/V_{OL} and HS400 reference load

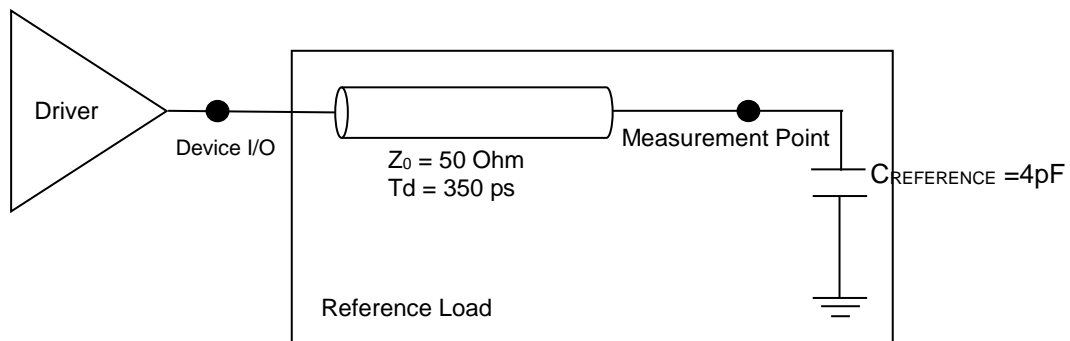

Figure 3 HS400 reference load

HS400 Capacitance

The Data Strobe is used to read data in HS400 mode. The Data Strobe is toggled only during data read or CRC s

Parameter	Symbol	Min	Typ.	Max	Unit	Remark
Pull-up resistance for CMD	R_{CMD}	4.7		100	K Ω	
Pull-up resistance for DAT0-7	R_{DAT}	10		100	K Ω	
Pull-down resistance for Data Strobe	R_{DS}	10		100	K Ω	
Internal pull up resistance DAT1-DAT7	R_{int}	10		150	K Ω	
Bus signal line capacitance	C_L			13	pF	
Single Device capacitance	C_{DEVICE}			6	pF	

Overshoot/Undershoot Specification

		V _{CCQ}	Unit
		1.70V-1.95V	
Maximum peak amplitude allowed for overshoot area. (See Figure Overshoot/Undershoot definition)	Max	0.9	V
Maximum peak amplitude allowed for undershoot area. (See Figure Overshoot/Undershoot definition)	Max	0.9	V
Maximum area above V _{CCQ} (See Figure Overshoot/Undershoot definition)	Max	1.5	V-ns
Maximum area below V _{SSQ} (See Figure Overshoot/Undershoot definition)	Max	1.5	V-ns

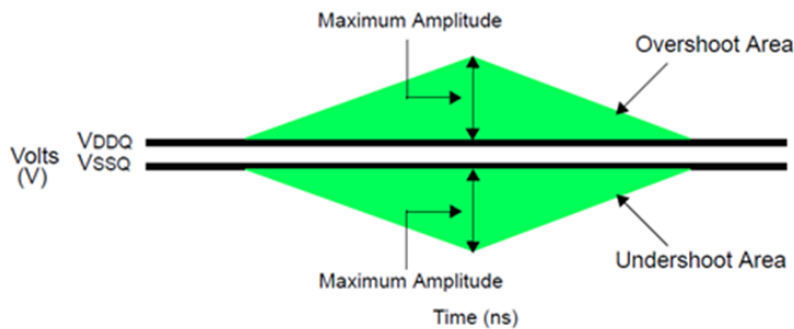
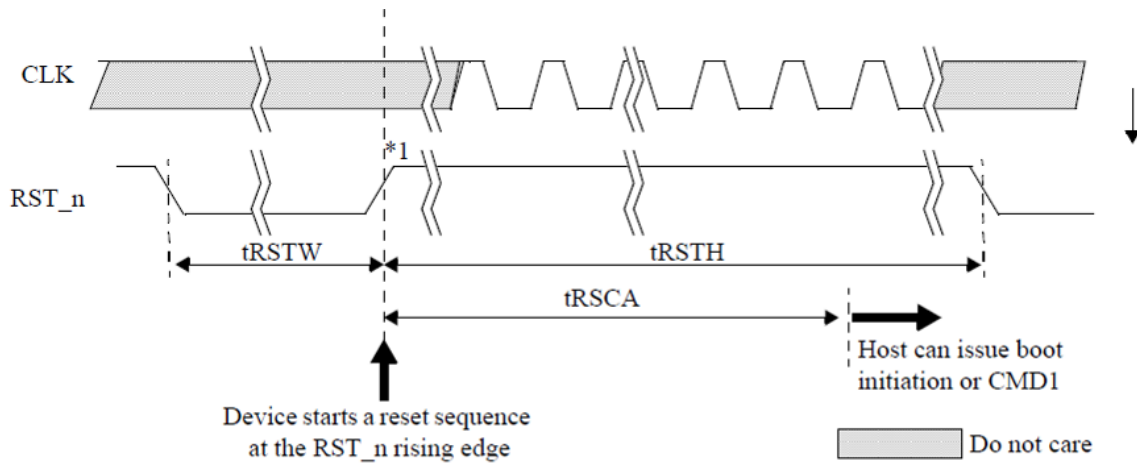

Figure 4 Overshoot/Undershoot definition

H/W Reset Operation



(Note) *1 : Device will detect the rising edge of RST_n signal to trigger internal reset sequence

H/W Reset Timings

Parameter	Symbol	Test Conditions	Min	Max	Unit
RST _n pulse width	tRSTW		1	—	μs
RST _n to Command time	tRSCA		200 ¹	—	μs
RST _n high period (interval time)	tRSTH		1	—	μs

1) 74 cycles of clock signal required before issuing CMD1 or CMD0 with argument 0xFFFFFFFF

2) During the device internal initialization sequence right after power on, device may not be able to detect RST_n signal, because the device may not complete loading RST_n_ENABLE bits of the extended CSD register into the controller yet.

Power-up sequence

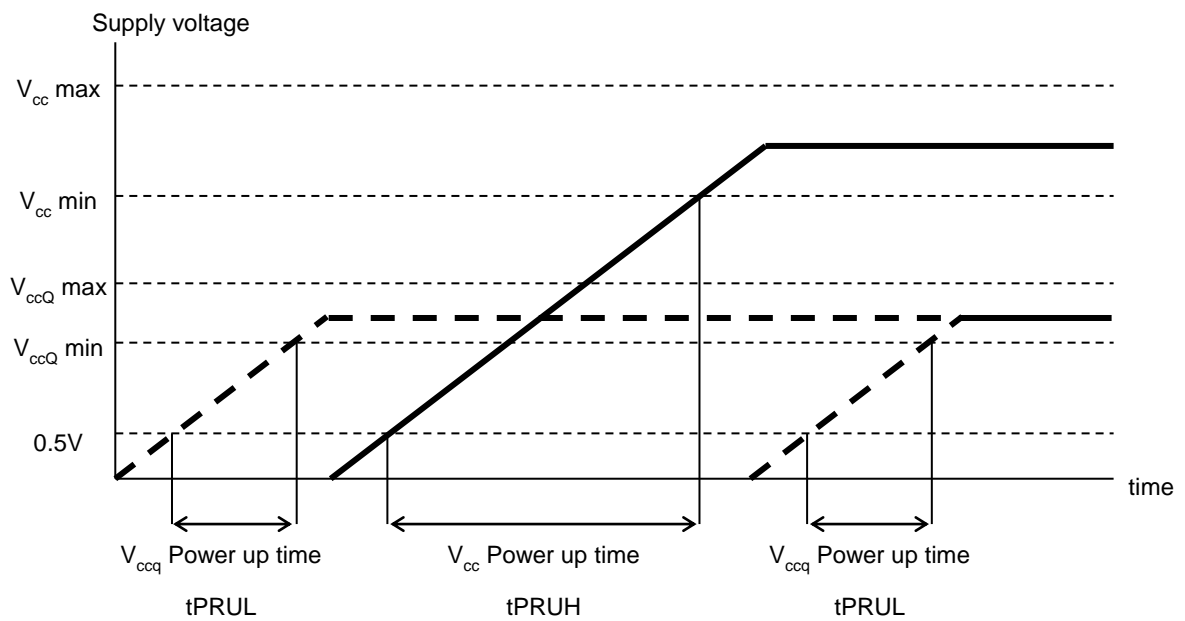

Figure 3 Power up sequence

Power-up parameter

Parameter	Symbol	Test Conditions	Min	Max	Remark
Supply power-up for 3.3V	tPRUH		5 μ s	35 ms	
Supply power-up for 1.8V	tPRUL		5 μ s	25 ms	

Functional restrictions

- Pre loading data size is limited to MAX_PRE_LOADING_DATA_SIZE[21-18] regardless of using Production State Awareness function.
- MAX_PRE_LOADING_DATA_SIZE[21-18] value will change when host sets Enhanced User area Partition.

Reliability Guidance

This reliability guidance is intended to notify some guidance related to using raw NAND flash. Although random bit errors may occur during use, it does not necessarily mean that a block is bad. Generally, a block should be marked as bad when a program status failure or erase status failure is detected. The other failure modes may be recovered by a block erase. ECC treatment for read data is mandatory due to the following Data Retention and Read Disturb failures.

-Write/Erase Endurance

Write/Erase endurance failures may occur in a cell, page, or block, and are detected by doing a status read after either an auto program or auto block erase operation. The cumulative bad block count will increase along with the number of write/erase cycles.

-Data Retention

The data in memory may change after a certain amount of storage time. This is due to charge loss or charge gain. After block erasure and reprogramming, the block may become usable again. Also write/erase endurance deteriorates data retention capability. The figure below shows a generic trend of relationship between write/erase endurance and data retention.

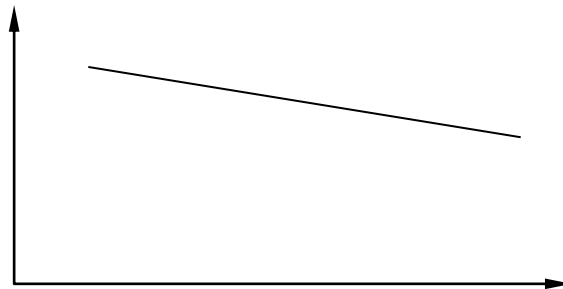

-Read Disturb

A read operation may disturb the data in memory. The data may change due to charge gain. Usually, bit errors occur on other pages in the block, not the page being read. After a large number of read cycles (between block erases), a tiny charge may build up and can cause a cell to be soft programmed to another state. After block erasure and reprogramming, the block may become usable again.

Considering the above failure modes, TOSHIBA recommends following usage:

- Please avoid any excessive iteration of resets and initialization sequences (Device identification mode) as far as possible after power-on, which may result in read disturb failure. The resets include hardware resets and software resets.

e.g.1) Iteration of the following command sequence, CMD0 - CMD1 ---

The assertion of CMD1 implies a count of internal read operation in Raw NAND.

CMD0: Reset command, CMD1: Send operation command

e.g.2) Iteration of the following commands, CMD30 and/or CMD31

CMD30: Send status of write protection bits, CMD31: Send type of write protection

Document Revision History

Rev0.1	Jan. 14th, 2015	- Released as preliminary revision.
Rev0.2	Feb. 4th, 2015	- Revised or fixed values of CSD Register and Extended CSD.(Page6-11)
Rev1.0	Feb. 4th, 2015	- Fixed values of Performance. - Fixed values of Operating Current and Sleep Mode Current. - Fixed values of CID/CSD/Extended-CSD value. - Released as final revision.

RESTRICTIONS ON PRODUCT USE

- Toshiba Corporation, and its subsidiaries and affiliates (collectively "TOSHIBA"), reserve the right to make changes to the information in this document, and related hardware, software and systems (collectively "Product") without notice.
- This document and any information herein may not be reproduced without prior written permission from TOSHIBA. Even with TOSHIBA's written permission, reproduction is permissible only if reproduction is without alteration/omission.
- Though TOSHIBA works continually to improve Product's quality and reliability, Product can malfunction or fail. Customers are responsible for complying with safety standards and for providing adequate designs and safeguards for their hardware, software and systems which minimize risk and avoid situations in which a malfunction or failure of Product could cause loss of human life, bodily injury or damage to property, including data loss or corruption. Before customers use the Product, create designs including the Product, or incorporate the Product into their own applications, customers must also refer to and comply with (a) the latest versions of all relevant TOSHIBA information, including without limitation, this document, the specifications, the data sheets and application notes for Product and the precautions and conditions set forth in the "TOSHIBA Semiconductor Reliability Handbook" and (b) the instructions for the application with which the Product will be used with or for. Customers are solely responsible for all aspects of their own product design or applications, including but not limited to (a) determining the appropriateness of the use of this Product in such design or applications; (b) evaluating and determining the applicability of any information contained in this document, or in charts, diagrams, programs, algorithms, sample application circuits, or any other referenced documents; and (c) validating all operating parameters for such designs and applications. **TOSHIBA ASSUMES NO LIABILITY FOR CUSTOMERS' PRODUCT DESIGN OR APPLICATIONS.**
- **PRODUCT IS NEITHER INTENDED NOR WARRANTED FOR USE IN EQUIPMENTS OR SYSTEMS THAT REQUIRE EXTRAORDINARILY HIGH LEVELS OF QUALITY AND/OR RELIABILITY, AND/OR A MALFUNCTION OR FAILURE OF WHICH MAY CAUSE LOSS OF HUMAN LIFE, BODILY INJURY, SERIOUS PROPERTY DAMAGE AND/OR SERIOUS PUBLIC IMPACT ("UNINTENDED USE").** Except for specific applications as expressly stated in this document, Unintended Use includes, without limitation, equipment used in nuclear facilities, equipment used in the aerospace industry, medical equipment, equipment used for automobiles, trains, ships and other transportation, traffic signaling equipment, equipment used to control combustions or explosions, safety devices, elevators and escalators, devices related to electric power, and equipment used in finance-related fields. **IF YOU USE PRODUCT FOR UNINTENDED USE, TOSHIBA ASSUMES NO LIABILITY FOR PRODUCT.** For details, please contact your TOSHIBA sales representative.
- Do not disassemble, analyze, reverse-engineer, alter, modify, translate or copy Product, whether in whole or in part.
- Product shall not be used for or incorporated into any products or systems whose manufacture, use, or sale is prohibited under any applicable laws or regulations.
- The information contained herein is presented only as guidance for Product use. No responsibility is assumed by TOSHIBA for any infringement of patents or any other intellectual property rights of third parties that may result from the use of Product. No license to any intellectual property right is granted by this document, whether express or implied, by estoppel or otherwise.
- **ABSENT A WRITTEN SIGNED AGREEMENT, EXCEPT AS PROVIDED IN THE RELEVANT TERMS AND CONDITIONS OF SALE FOR PRODUCT, AND TO THE MAXIMUM EXTENT ALLOWABLE BY LAW, TOSHIBA (1) ASSUMES NO LIABILITY WHATSOEVER, INCLUDING WITHOUT LIMITATION, INDIRECT, CONSEQUENTIAL, SPECIAL, OR INCIDENTAL DAMAGES OR LOSS, INCLUDING WITHOUT LIMITATION, LOSS OF PROFITS, LOSS OF OPPORTUNITIES, BUSINESS INTERRUPTION AND LOSS OF DATA, AND (2) DISCLAIMS ANY AND ALL EXPRESS OR IMPLIED WARRANTIES AND CONDITIONS RELATED TO SALE, USE OF PRODUCT, OR INFORMATION, INCLUDING WARRANTIES OR CONDITIONS OF MERCHANTABILITY, FITNESS FOR A PARTICULAR PURPOSE, ACCURACY OF INFORMATION, OR NONINFRINGEMENT.**
- Do not use or otherwise make available Product or related software or technology for any military purposes, including without limitation, for the design, development, use, stockpiling or manufacturing of nuclear, chemical, or biological weapons or missile technology products (mass destruction weapons). Product and related software and technology may be controlled under the applicable export laws and regulations including, without limitation, the Japanese Foreign Exchange and Foreign Trade Law and the U.S. Export Administration Regulations. Export and re-export of Product or related software or technology are strictly prohibited except in compliance with all applicable export laws and regulations.
- Please contact your TOSHIBA sales representative for details as to environmental matters such as the RoHS compatibility of Product. Please use Product in compliance with all applicable laws and regulations that regulate the inclusion or use of controlled substances, including without limitation, the EU RoHS Directive. **TOSHIBA ASSUMES NO LIABILITY FOR DAMAGES OR LOSSES OCCURRING AS A RESULT OF NONCOMPLIANCE WITH APPLICABLE LAWS AND REGULATIONS.**