

TOSHIBA BIPOLAR LINEAR INTEGRATED CIRCUIT SILICON MONOLITHIC

TA4003F

VHF~UHF WIDE BAND AMPLIFIER

FEATURES

- Band Width 1.5CHz (Typ.) (3dB down, $V_{CC} = 2V$)
- High Gain : $|S_{21}|^2 = 11dB$ (Typ.), ($f = 500MHz$, $V_{CC} = 2V$)
- Operating Supply Voltage : $V_{CC} = 2\sim 3V$
- Low Current Operation : $I_{CC} = 3.5mA$ (Typ.) ($V_{CC} = 2V$)
- Small Package

PIN ASSIGNMENT (TOP VIEW)

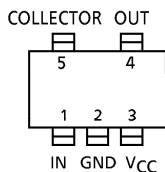

Marking

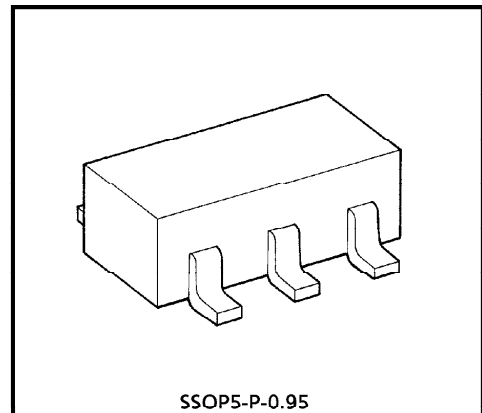
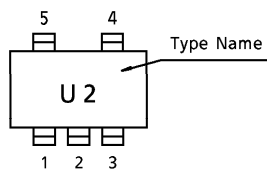

Weight : 0.014g (Typ.)

MAXIMUM RATINGS ($T_a = 25^\circ C$)

CHARACTERISTIC	SYMBOL	RATING	UNIT
Supply Voltage	V_{CC}	4	V
Total Power Dissipation	P_D^*	300	mW
Operating Temperature	T_{opr}	- 40~85	$^\circ C$
Storage Temperature	T_{stg}	- 55~125	$^\circ C$

* When mounted glass epoxy of $2.5cm^2 \times 1.6t$

961001EBA2

- TOSHIBA is continually working to improve the quality and the reliability of its products. Nevertheless, semiconductor devices in general can malfunction or fail due to their inherent electrical sensitivity and vulnerability to physical stress. It is the responsibility of the buyer, when utilizing TOSHIBA products, to observe standards of safety, and to avoid situations in which a malfunction or failure of a TOSHIBA product could cause loss of human life, bodily injury or damage to property. In developing your designs, please ensure that TOSHIBA products are used within specified operating ranges as set forth in the most recent products specifications. Also, please keep in mind the precautions and conditions set forth in the TOSHIBA Semiconductor Reliability Handbook.
- The products described in this document are subject to foreign exchange and foreign trade control laws.
- The information contained herein is presented only as a guide for the applications of our products. No responsibility is assumed by TOSHIBA CORPORATION for any infringements of intellectual property or other rights of the third parties which may result from its use. No license is granted by implication or otherwise under any intellectual property or other rights of TOSHIBA CORPORATION or others.
- The information contained herein is subject to change without notice.

ELECTRICAL CHARACTERISTICS (Ta = 25°C) (Note 1)

CHARACTERISTIC	SYMBOL	TEST CIRCUIT	TEST CONDITION	MIN.	TYP.	MAX.	UNIT
Circuit Current	I _{CC}	—	V _{CC} = 2V, Non carrier	2.5	3.5	4.5	mA
Insertion Gain	S ₂₁ ²	1	V _{CC} = 2V, f = 500MHz	9	11	14	dB
Band Width	BW	1	V _{CC} = 2V (Note 2)	1.2	1.5	—	GHz
Noise Figure	NF	1	V _{CC} = 2V, f = 500MHz	—	5.2	7	dB
Input Return Loss	S ₁₁ ²	1	V _{CC} = 2V, f = 500MHz	—	-7.5	—	dB
Output Return Loss	S ₂₂ ²	1	V _{CC} = 2V, f = 500MHz	—	-7.5	—	dB
Isolation	S ₁₂ ²	1	V _{CC} = 2V, f = 500MHz	—	-24	—	dB
Maximum Output Level	P _O	1	V _{CC} = 2V, f = 500MHz, Pin = 0dBmW	—	0	—	dBmW

Note 1 : Have use for connect inductance between terminal 4 and 5 8nH at V_{CC} = 2V
 Note 2 : BW is frequency of 3dB down from |S₂₁|² at 500MHz.

TEST CIRCUIT 1. (TOP VIEW)

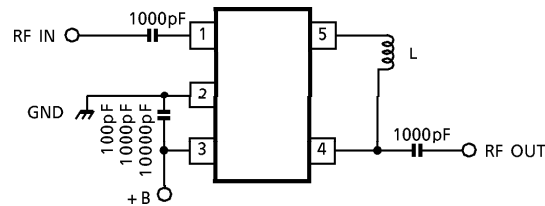

EQUIVALENT CIRCUIT

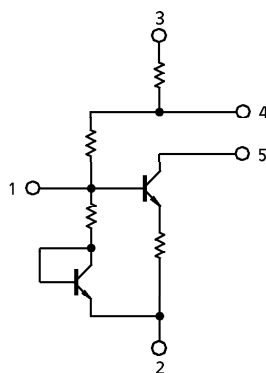

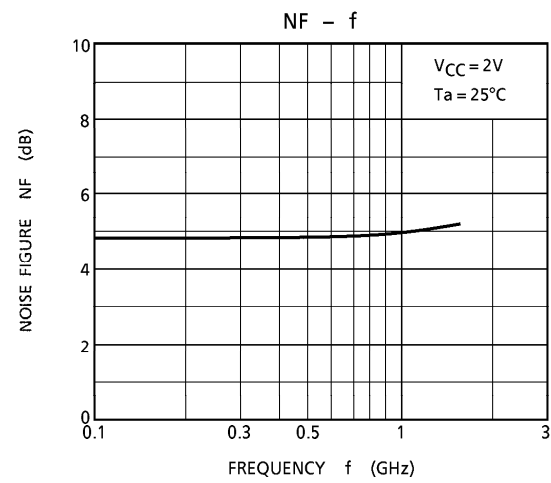
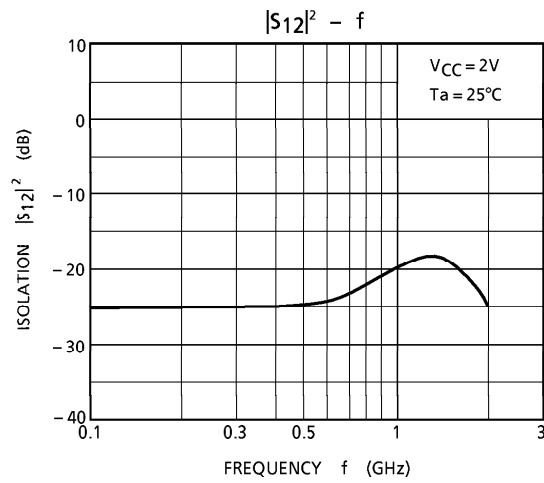
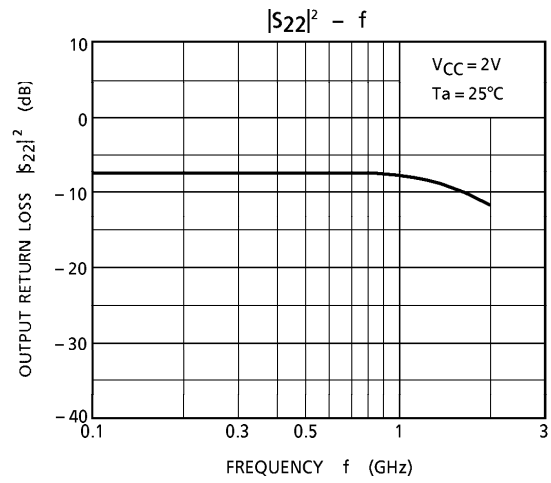
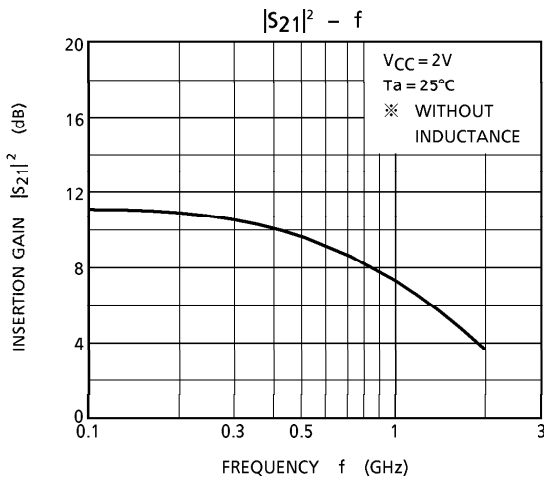
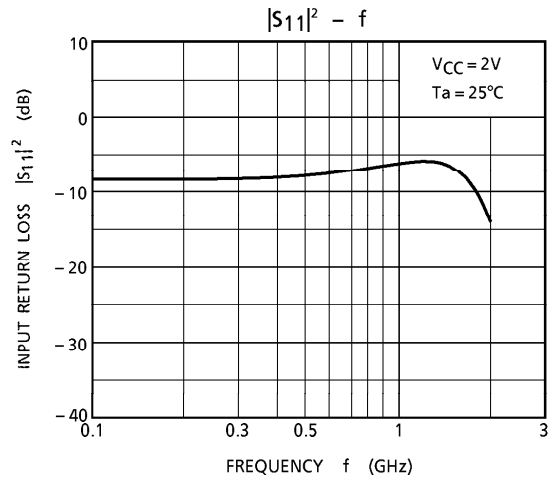
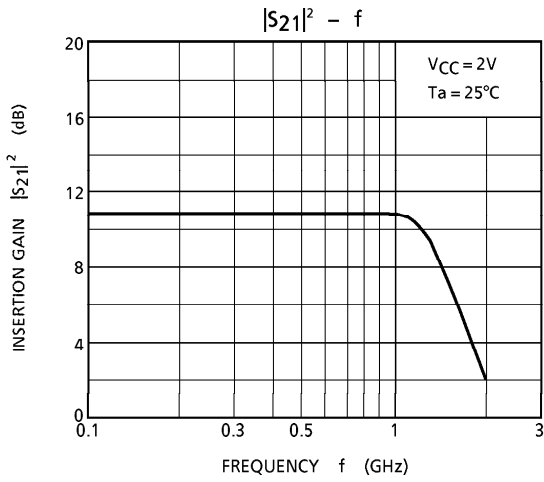

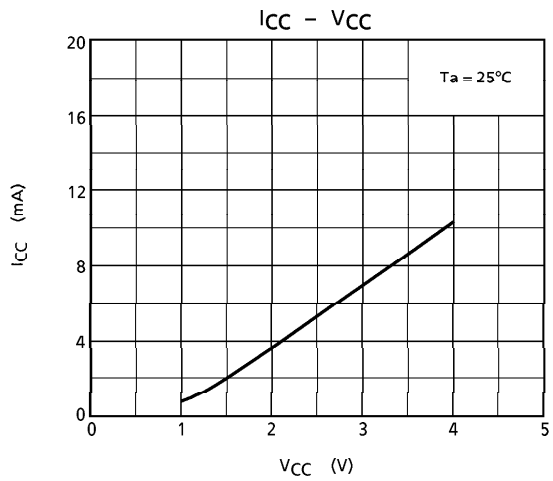
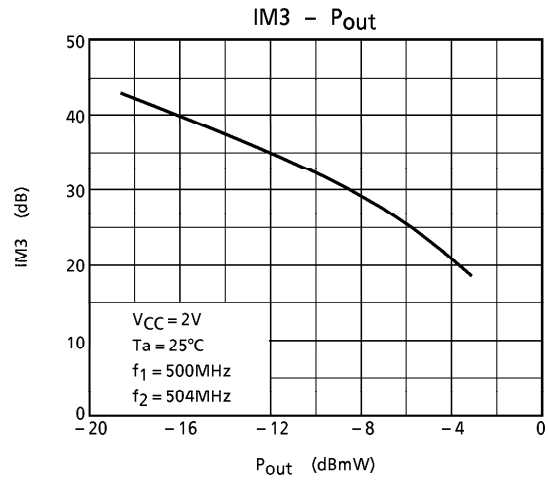
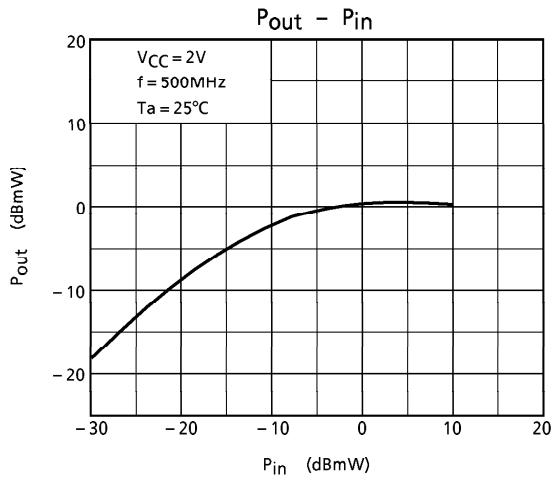

OUTLINE DRAWING
SSOP5-P-0.95

Unit : mm

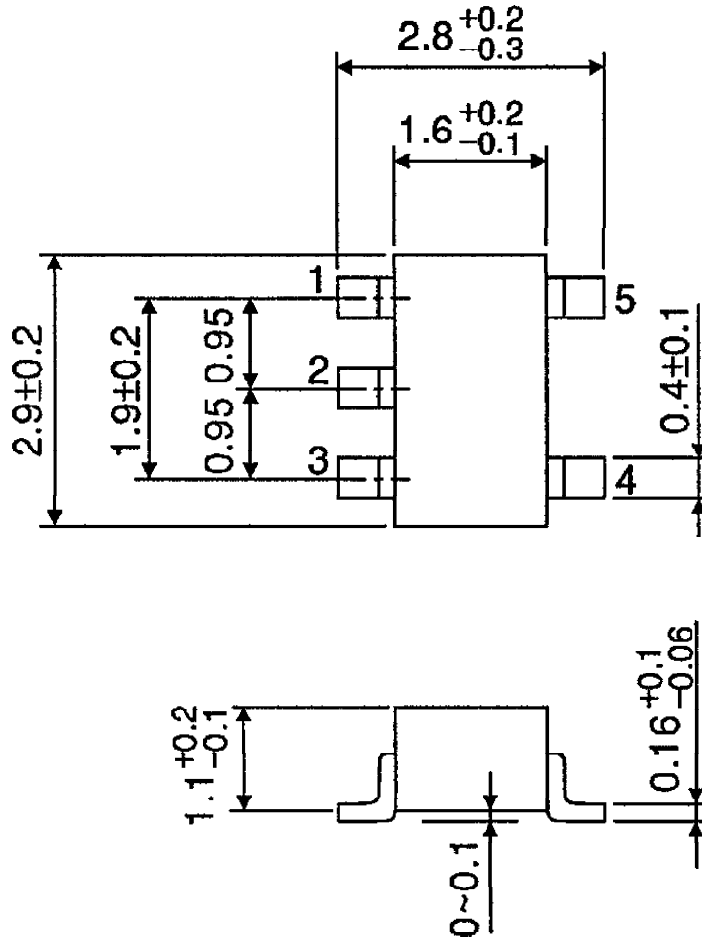

Weight : 0.014g (Typ.)