

SZSMF Series



Description

The SZSMF series is designed to protect sensitive systems or components from high voltage, high energy transients. It offers a fast response time, low Zener impedance, high surge and excellent clamping capabilities. Because of its small size, it is ideal for use in cellular phones, portable devices, business machines, power supplies and other industrial and consumer applications.

Features

- Zener Transient Overvoltage Suppressors
- Stand-off Voltage: 5 – 58 Volts
- Peak Power: 200 Watts @ 1 ms
- Low Leakage
- Response Time is Typically < 1 ns
- ESD Rating of Class 3 (> 16 kV) per Human Body Model
- ESD Rating of Level 4 (8 kV Contact Discharge) per IEC 61000-4-2
- EFT (Electrical Fast Transients) Rating of 40 A per IEC 61000-4-4
- Low Profile: Maximum Height of 1.0 mm
- Small Footprint: Footprint Area of 8.45 mm²
- Supplied in 8 mm Tape and Reel – 3,000 Units per Reel
- Cathode Indicated by Polarity Band
- Lead Orientation in Tape: Cathode Lead to Sprocket Holes
- These components are Pb-Free and are RoHS Compliant
- SZ Prefix for Automotive and Other Applications Requiring Unique Site and Control Change Requirements; AEC-Q101 Qualified and PPAP Capable

Agency Approvals

AGENCY	AGENCY FILE NUMBER
	E128662

Maximum Ratings and Thermal Characteristics

Rating	Symbol	Value	Unit
Maximum P _{pk} Dissipation (PW=10/1000 μs) (Note 1)	P _{PK}	200	W
Maximum P _{PK} Dissipation @ T _A = 25°C, (PW=8/20 μs) (Note 2)	P _{PK}	1000	W
DC Power Dissipation @ T _A = 25°C (Note 3)	P _D	385	mW
Derate Above 25°C		4.0	mW/°C
Thermal Resistance from Junction-to-Ambient (Note 3)	R _{θJA}	325	°C/W
Thermal Resistance, Junction-to-Lead (Note3)	R _{θJL}	26	°C/W
Operating and Storage Temperature Range	T _J , T _{stg}	-55 to +150	°C

Stresses exceeding Maximum Ratings may damage the component. Maximum Ratings are stress ratings only. Functional operation above the Recommended Operating Conditions is not implied. Extended exposure to stresses above the Recommended Operating Conditions may affect component reliability.

1. Non-repetitive current pulse at T_A = 25°C, per waveform of Figure 2.
2. Non-repetitive current pulse at T_A = 25°C, per waveform of Figure 3.
3. Mounted with recommended minimum pad size, DC board FR-4.
4. 1/2 sine wave (or equivalent square wave), PW = 8.3 ms, duty cycle = 4 pulses per minute maximum.

Functional Diagram

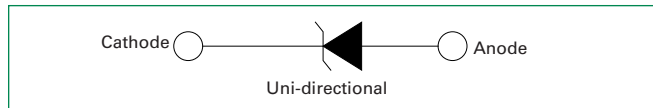

Additional Information



Datasheet



Resources



Samples

Electrical Characteristics ($T_L = 30^\circ\text{C}$ unless otherwise noted, $V_F = 1.25$ Volts @ 200 mA)

Device	Device Marking	V_{RWM}	$V_{BR} @ I_T$ (V) (Note 6)			@ I_T	$I_R @ V_{RWM}$	$V_C(\text{Max})$	$I_{PP}(\text{Max})$ (A)
			V	Min	Nom				
SZSMF5.0AT1G	KE	5	6.40	6.70	7.00	10	400	9.2	21.7
SZSMF6.0AT1G	KG	6	6.67	7.02	7.37	10	400	10.3	19.4
SZSMF6.5AT1G	KK	6.5	7.22	7.60	7.98	10	250	11.2	17.9
SZSMF7.0AT1G	KM	7	7.78	8.19	8.60	10	100	12	16.7
SZSMF7.5AT1G	KP	7.5	8.33	8.77	9.21	1	50	12.9	15.5
SZSMF8.0AT1G	KR	8	8.89	9.36	9.83	1	25	13.6	14.7
SZSMF9.0AT1G	KV	9	10.00	10.55	11.10	1	5	15.4	13.0
SZSMF10AT1G	KX	10	11.10	11.70	12.30	1	2.5	17	11.8
SZSMF11AT1G	KZ	11	12.20	12.85	13.50	1	2.5	18.2	11.0
SZSMF12AT1G	LE	12	13.30	14.00	14.70	1	2.5	19.9	10.1
SZSMF13AT1G	LG	13	14.40	15.15	15.90	1	1	21.5	9.3
SZSMF14AT1G	LK	14	15.60	16.40	17.20	1	1	23.2	8.6
SZSMF15AT1G	LM	15	16.70	17.60	18.50	1	1	24.4	8.2
SZSMF18AT1G	LT	18	20.00	21.00	22.10	1	1	29.2	6.8
SZSMF20AT1G	LV	20	22.20	23.35	24.50	1	1	32.4	6.2
SZSMF22AT1G	LX	22	24.40	25.60	26.90	1	1	35.5	5.6
SZSMF24AT1G	LZ	24	26.70	28.10	29.50	1	1	38.9	5.1
SZSMF26AT1G	ME	26	28.90	30.40	31.90	1	1	42.1	4.8
SZSMF28AT1G	MG	28	31.10	32.80	34.40	1	1	45.4	4.4
SZSMF30AT1G	MK	30	33.30	35.10	36.80	1	1	48.4	4.1
SZSMF33AT1G	MM	33	36.70	38.70	40.60	1	1	53.3	3.8
SZSMF36AT1G	MP	36	40.00	42.10	44.20	1	1	58.1	3.4
SZSMF48AT1G	MX	48	53.30	56.10	58.90	1	1	77.4	2.6
SZSMF58AT1G	NG	58	64.40	67.80	71.20	1	1	93.6	2.1

- A transient suppressor is normally selected according to the Working Peak Reverse Voltage (V_{RWM}) which should be equal to or greater than the DC or continuous peak operating voltage level.
- V_{BR} measured at pulse test current I_T at ambient temperature of 25°C .
- Surge current waveform per Figure 2 and derate per Figure 3.

I-V Curve Characteristics ($T_A = 25^\circ\text{C}$ unless otherwise noted, $V_F = 3.5$ V Max. @ I_F (Note 4) = 12 A)

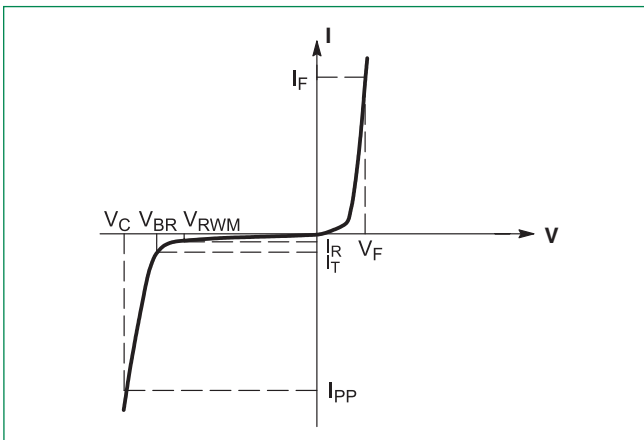

Symbol	Parameter
I_{PP}	Maximum Reverse Peak Pulse Current
V_C	Clamping Voltage @ I_{PP}
V_{RWM}	Working Peak Reverse Voltage
I_R	Maximum Reverse Leakage Current @ V_{RWM}
V_{BR}	Breakdown Voltage @ I_T
I_T	Test Current
I_F	Forward Current
V_F	Forward Voltage @ I_F

Ratings and Characteristic Curves

Figure 1. Pulse Rating Curve

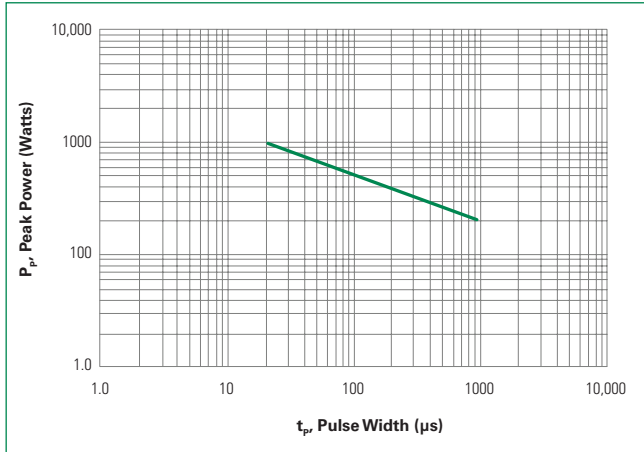

Figure 2. 10/1000 µs Pulse Waveform

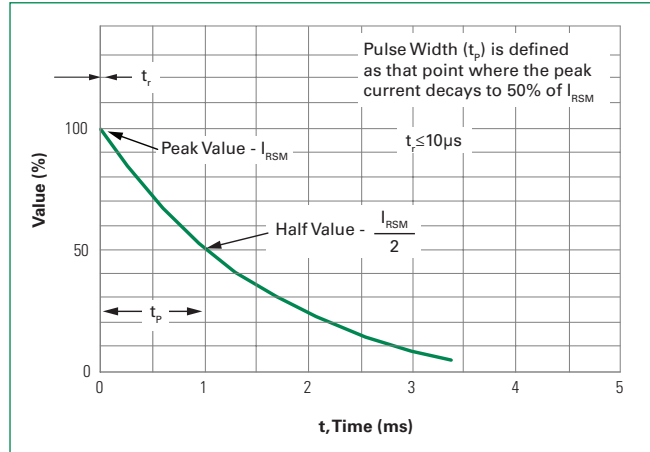

Figure 3. 8/20 µs Pulse Waveform

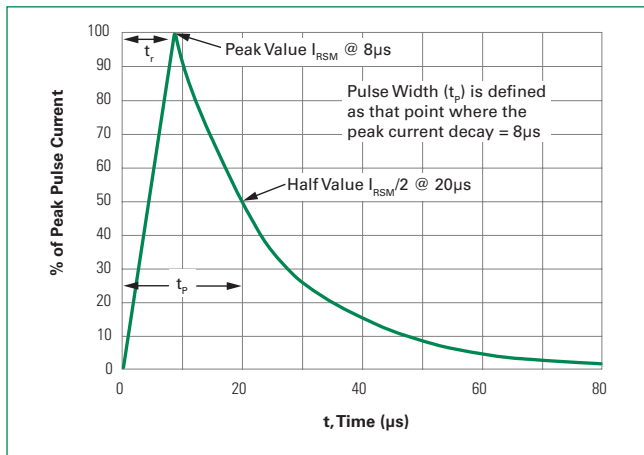

Figure 4. Surge Derating Curve

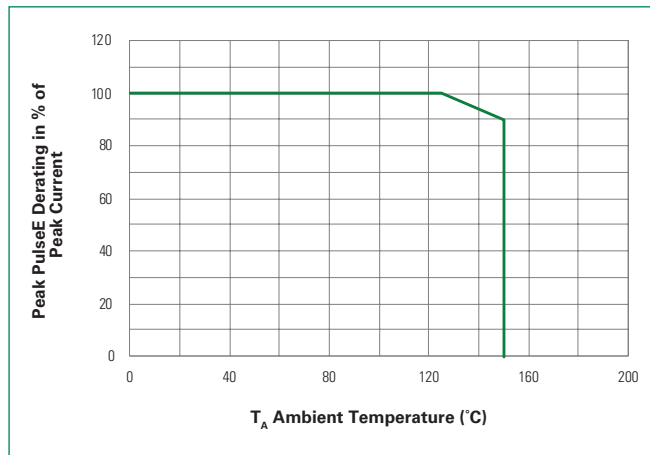

Figure 5. Typical Derating Factor for Duty Cycle

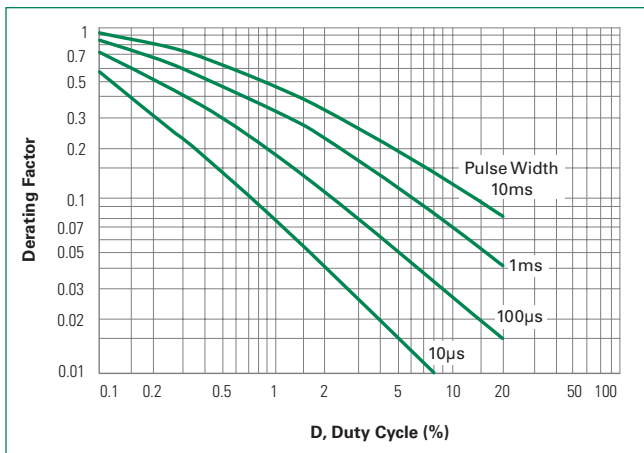

Figure 6. Steady State Power Derating

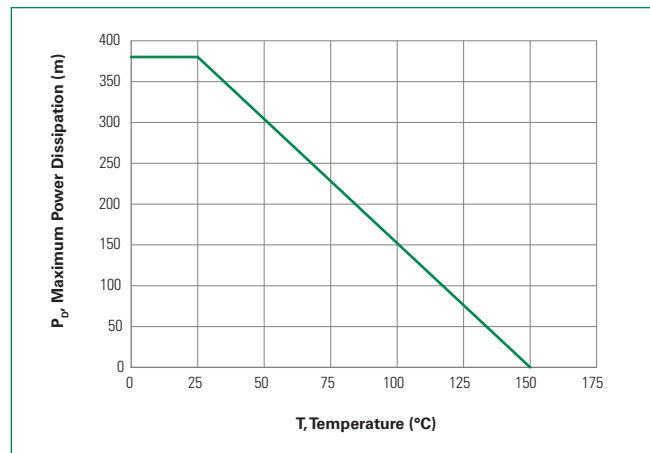

Figure 7. Forward Voltage

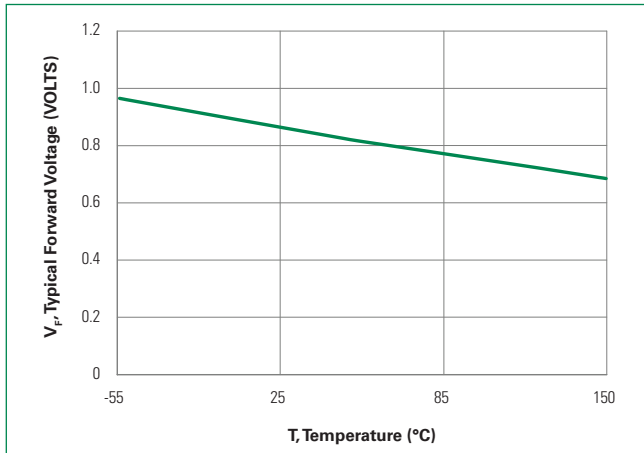
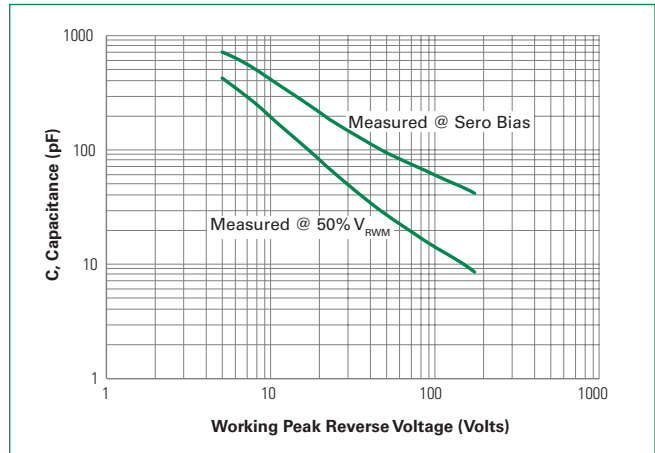
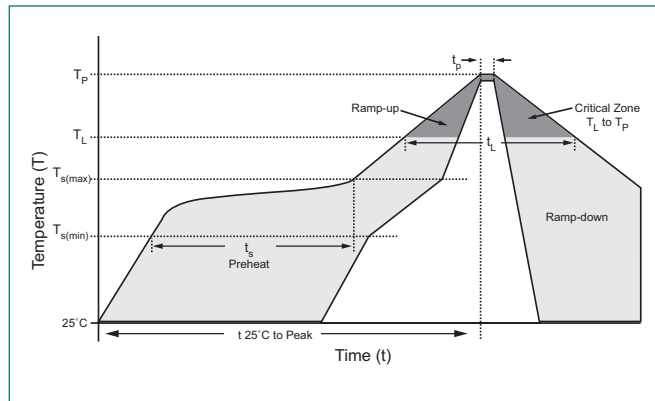

Figure 8. Capacitance vs. Working Peak Reverse Voltage



Soldering Parameters

Reflow Condition		Lead-free assembly
Pre Heat	- Temperature Min ($T_{s(min)}$)	150°C
	- Temperature Max ($T_{s(max)}$)	200°C
	- Time (min to max) (t_s)	60 – 120 secs
Average ramp up rate (Liquidus Temp (T_L) to peak)		3°C/second max
$T_{s(max)}$ to T_L - Ramp-up Rate		3°C/second max
Reflow	- Temperature (T_L) (Liquidus)	217°C
	- Time (min to max) (t_L)	60 – 150 seconds
Peak Temperature (T_p)		260 ^{+0/-5} °C
Time within 5°C of actual peak Temperature (t_p)		30 seconds max
Ramp-down Rate		6°C/second max
Time 25°C to peak Temperature (T_p)		8 minutes Max.
Do not exceed		260°C



Physical Specifications

Weight	0.004 ounce ,0.0116 grams
Case	JEDEC SOD-123FL. Void-free, transfer-molded, thermosetting plastic epoxy meets UL 94V-0
Polarity	Color band denotes positive end (cathode) except Bidirectional.
Terminal	Matte Tin-plated leads, Solderable per JESD22-B102

Environmental Specifications

High Temp. Storage	JESD22-A103
HTRB	JESD22-A108
Temperature Cycling	JESD22-A104
MSL	JEDEC-J-STD-020, Level 1
H3TRB	JESD22-A101
RSH	JESD22-A111

Dimensions

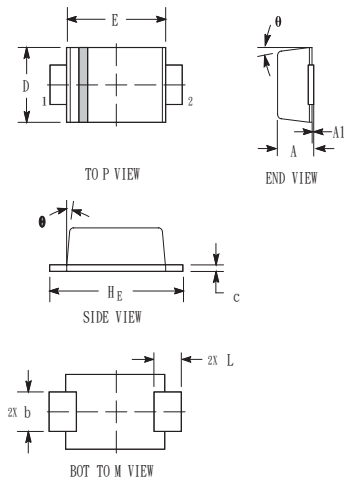

Dim	Millimeters			Inches		
	Min	Nom	Max	Min	Nom	Max
A	0.90	0.95	0.98	0.035	0.037	0.039
A1	0.00	0.05	0.10	0.000	0.002	0.004
b	0.70	0.90	1.10	0.028	0.035	0.043
c	0.10	0.15	0.20	0.004	0.006	0.008
D	1.50	1.65	1.80	0.059	0.065	0.071
E	2.50	2.70	2.90	0.098	0.106	0.114
L	0.55	0.75	0.95	0.022	0.030	0.037
H _E	3.40	3.60	3.80	0.134	0.142	0.150
Θ	0°	-	8°	0°	-	8°

Soldering Footprint

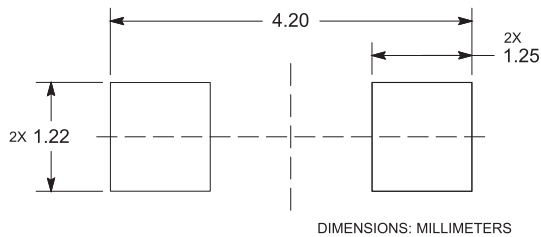

Ordering Information

Device	Package	Shipping
SZSMFxxxAT1G	SOD-123FL (Pb-Free)	3,000 / Tape & Reel

Part Marking System

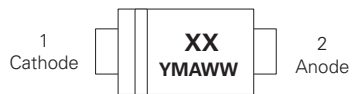

XX = Device Code
Y = Year
M = Month
A = Assembly Location
WW = Lot Code

Part Numbering System

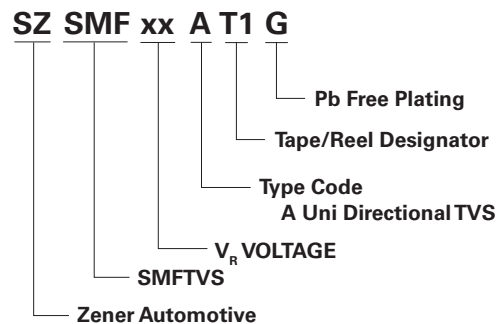

Tape and Reel Specification

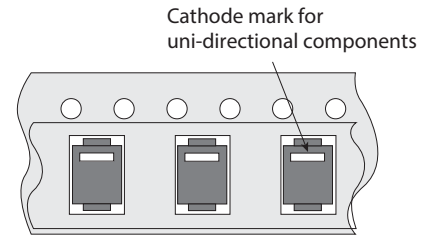
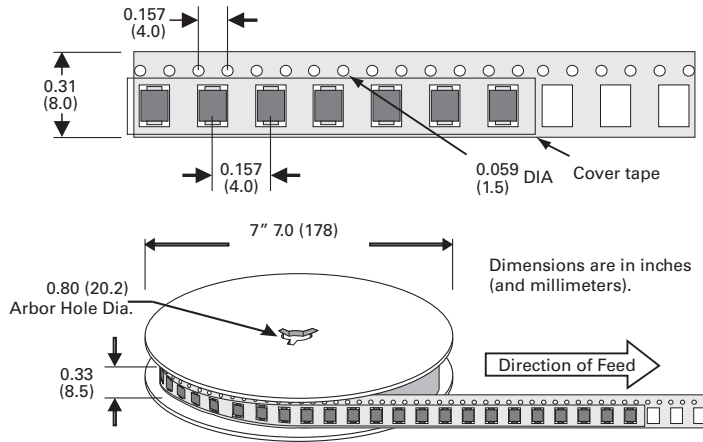

Disclaimer Notice - Information furnished is believed to be accurate and reliable. However, users should independently evaluate the suitability of and test each product selected for their own applications. Littelfuse products are not designed for, and may not be used in, all applications. Read complete Disclaimer Notice at: www.littelfuse.com/disclaimer-electronics.