

N-channel 650 V, 93 mΩ typ., 32 A MDmesh DM2 Power MOSFET in a TO-247 package

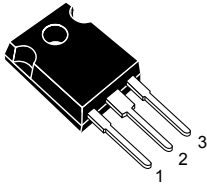

TO-247

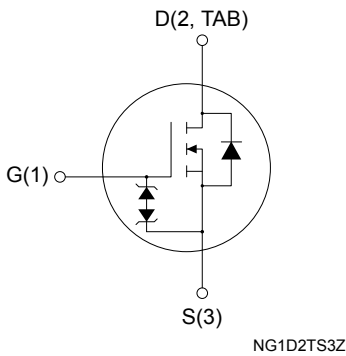

Features

Order code	V_{DS}	$R_{DS(on)}$ max.	I_D
STW35N65DM2	650 V	110 mΩ	32 A

- Fast-recovery body diode
- Extremely low gate charge and input capacitance
- Low on-resistance
- 100% avalanche tested
- Extremely high dv/dt ruggedness
- Zener-protected

Applications

- Switching applications

Description

This high-voltage N-channel Power MOSFET is part of the MDmesh DM2 fast-recovery diode series. It offers very low recovery charge (Q_{rr}) and time (t_{rr}) combined with low $R_{DS(on)}$, rendering it suitable for the most demanding high-efficiency converters and ideal for bridge topologies and ZVS phase-shift converters.

Product status link

[STW35N65DM2](#)

Product summary

Order code	STW35N65DM2
Marking	35N65DM2
Package	TO-247
Packing	Tube

1 Electrical ratings

Table 1. Absolute maximum ratings

Symbol	Parameter	Value	Unit
V _{GS}	Gate-source voltage (static)	±25	V
	Gate-source voltage (dynamic AC (f > 1 Hz))	±30	
I _D	Drain current (continuous) at T _C = 25 °C	32	A
	Drain current (continuous) at T _C = 100 °C	20	
I _{DM} ⁽¹⁾	Drain current (pulsed)	90	A
P _{TOT}	Total power dissipation at T _C = 25 °C	250	W
dv/dt ⁽²⁾	Peak diode recovery voltage slope	100	V/ns
di/dt ⁽²⁾	Peak diode recovery current slope	1000	A/μs
dv/dt ⁽³⁾	MOSFET dv/dt ruggedness	100	V/ns
T _{stg}	Storage temperature	-55 to 150	°C
T _J	Operating junction temperature		

1. Pulse width is limited by safe operating area.
2. $I_{SD} \leq 32$ A, $V_{DS\ peak} < V_{(BR)DSS}$, $V_{DD} = 80\% V_{(BR)DSS}$.
3. $V_{DS} \leq 520$ V.

Table 2. Thermal data

Symbol	Parameter	Value	Unit
R _{thj-case}	Thermal resistance junction-case	0.5	°C/W
R _{thj-amb}	Thermal resistance junction-ambient	50	°C/W

Table 3. Avalanche characteristics

Symbol	Parameter	Value	Unit
I _{AR}	Avalanche current, repetitive or not repetitive	4	A
E _{AS} ⁽¹⁾	Single pulse avalanche energy	1150	mJ

1. Starting T_J = 25 °C, I_D = I_{AR}, V_{DD} = 50 V.

2 Electrical characteristics

($T_C = 25\text{ °C}$ unless otherwise specified)

Table 4. Static

Symbol	Parameter	Test conditions	Min.	Typ.	Max.	Unit
$V_{(BR)DSS}$	Drain-source breakdown voltage	$V_{GS} = 0\text{ V}$, $I_D = 1\text{ mA}$	650			V
I_{DSS}	Zero gate voltage drain current	$V_{GS} = 0\text{ V}$, $V_{DS} = 650\text{ V}$			1	μA
		$V_{GS} = 0\text{ V}$, $V_{DS} = 650\text{ V}$, $T_C = 125\text{ °C}^{(1)}$			100	
I_{GSS}	Gate-body leakage current	$V_{DS} = 0\text{ V}$, $V_{GS} = \pm 25\text{ V}$			± 5	μA
$V_{GS(th)}$	Gate threshold voltage	$V_{DS} = V_{GS}$, $I_D = 250\text{ }\mu\text{A}$	3	4	5	V
$R_{DS(on)}$	Static drain-source on-resistance	$V_{GS} = 10\text{ V}$, $I_D = 16\text{ A}$		93	110	$\text{m}\Omega$

1. Defined by design, not subject to production test.

Table 5. Dynamic

Symbol	Parameter	Test conditions	Min.	Typ.	Max.	Unit
C_{iss}	Input capacitance	$V_{DS} = 100\text{ V}$, $f = 1\text{ MHz}$, $V_{GS} = 0\text{ V}$	-	2540	-	pF
C_{oss}	Output capacitance		-	115	-	pF
C_{riss}	Reverse transfer capacitance		-	2.5	-	pF
$C_{oss\text{ eq.}}^{(1)}$	Equivalent output capacitance	$V_{DS} = 0\text{ to }520\text{ V}$, $V_{GS} = 0\text{ V}$	-	204	-	pF
R_G	Intrinsic gate resistance	$f = 1\text{ MHz}$, $I_D = 0\text{ A}$	-	4.2	-	Ω
Q_g	Total gate charge	$V_{DD} = 520\text{ V}$, $I_D = 32\text{ A}$, $V_{GS} = 0\text{ to }10\text{ V}$ (see Figure 14. Test circuit for gate charge behavior)	-	56.3	-	nC
Q_{gs}	Gate-source charge		-	12.7	-	nC
Q_{gd}	Gate-drain charge		-	27.6	-	nC

1. $C_{oss\text{ eq.}}$ is defined as a constant equivalent capacitance giving the same charging time as C_{oss} when V_{DS} increases from 0 to 80% V_{DSS} .

Table 6. Switching times

Symbol	Parameter	Test conditions	Min.	Typ.	Max.	Unit
$t_{d(on)}$	Turn-on delay time	$V_{DD} = 325\text{ V}$, $I_D = 16\text{ A}$, $R_G = 4.7\text{ }\Omega$, $V_{GS} = 10\text{ V}$	-	23.4	-	ns
t_r	Rise time		-	23	-	ns
$t_{d(off)}$	Turn-off delay time	(see Figure 13. Test circuit for resistive load switching times and Figure 18. Switching time waveform)	-	72	-	ns
t_f	Fall time		-	10.4	-	ns

Table 7. Source-drain diode

Symbol	Parameter	Test conditions	Min.	Typ.	Max.	Unit
I_{SD}	Source-drain current		-		32	A
$I_{SDM}^{(1)}$	Source-drain current (pulsed)		-		90	A
$V_{SD}^{(2)}$	Forward on voltage	$V_{GS} = 0\text{ V}$, $I_{SD} = 32\text{ A}$	-		1.6	V
t_{rr}	Reverse recovery time	$I_{SD} = 32\text{ A}$, $di/dt = 100\text{ A}/\mu\text{s}$, $V_{DD} = 60\text{ V}$ (see Figure 15. Test circuit for inductive load switching and diode recovery times)	-	100		ns
Q_{rr}	Reverse recovery charge		-	0.42		μC
I_{RRM}	Reverse recovery current		-	8.4		A
t_{rr}	Reverse recovery time	$I_{SD} = 32\text{ A}$, $di/dt = 100\text{ A}/\mu\text{s}$, $V_{DD} = 60\text{ V}$, $T_J = 150\text{ }^\circ\text{C}$ (see Figure 15. Test circuit for inductive load switching and diode recovery times)	-	205		ns
Q_{rr}	Reverse recovery charge		-	1.8		μC
I_{RRM}	Reverse recovery current		-	17.6		A

1. Pulse width is limited by safe operating area.
2. Pulse test: pulse duration = 300 μs , duty cycle 1.5%.

2.1 Electrical characteristics (curves)

Figure 1. Safe operating area

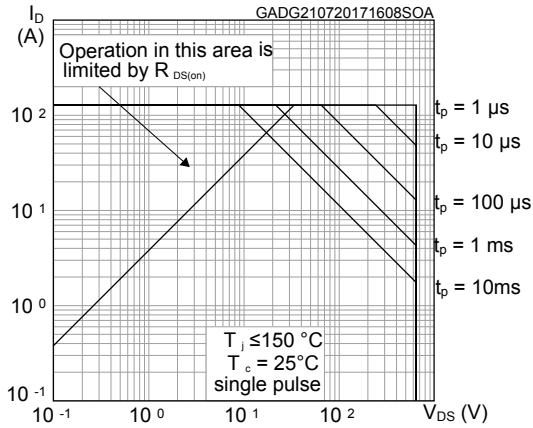

Figure 2. Thermal impedance

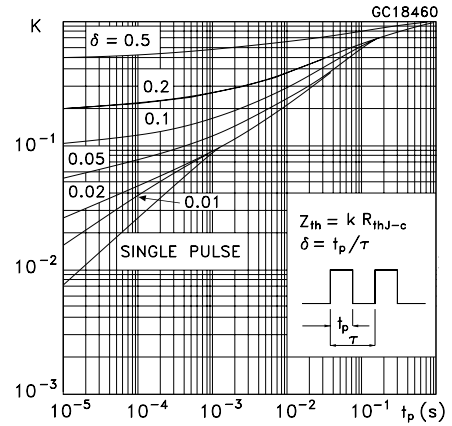

Figure 3. Output characteristics

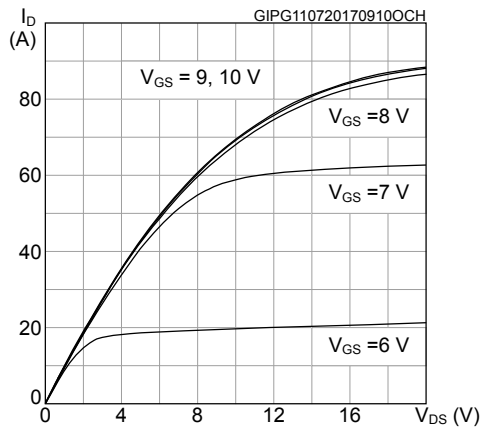

Figure 4. Transfer characteristics

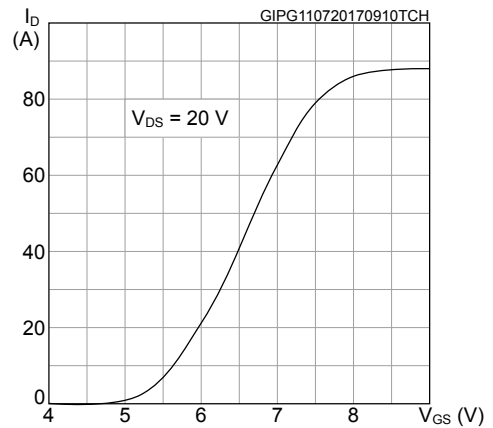

Figure 5. Gate charge vs gate-source voltage

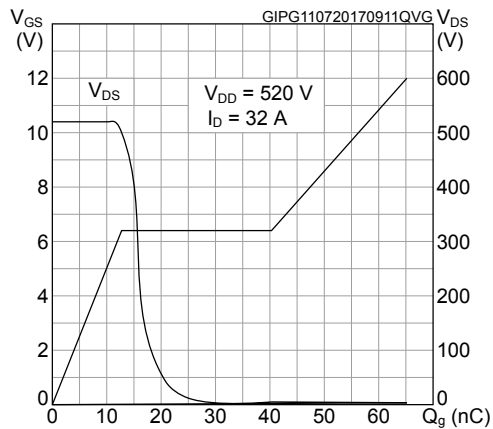

Figure 6. Static drain-source on-resistance

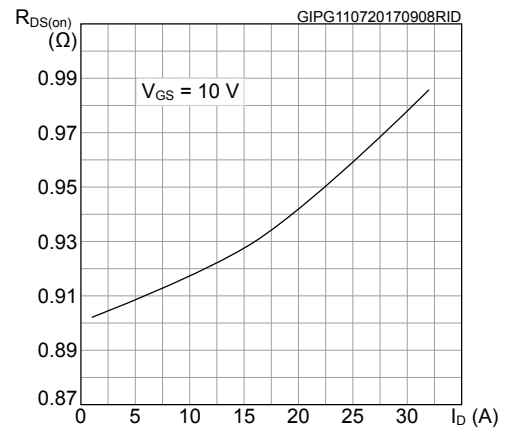

Figure 7. Capacitance variations

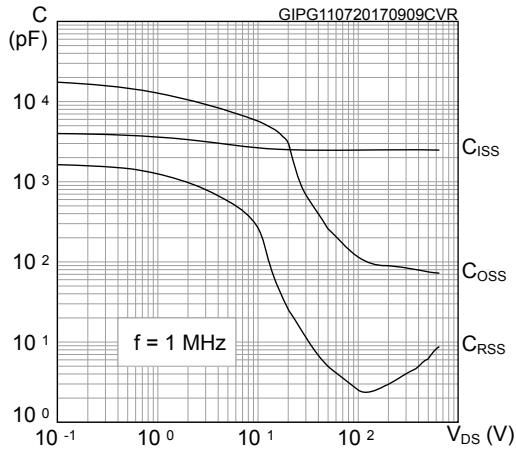

Figure 8. Normalized gate threshold voltage vs temperature

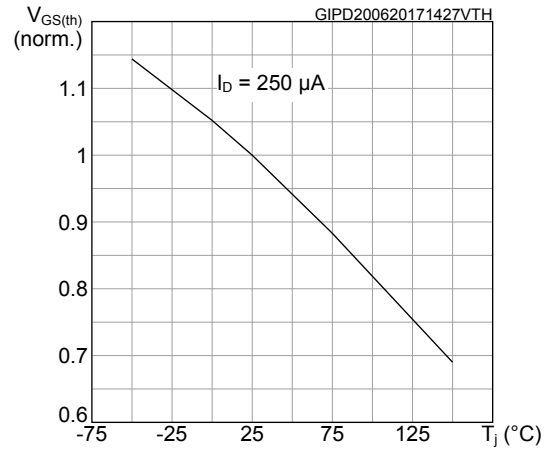

Figure 9. Normalized on-resistance vs temperature

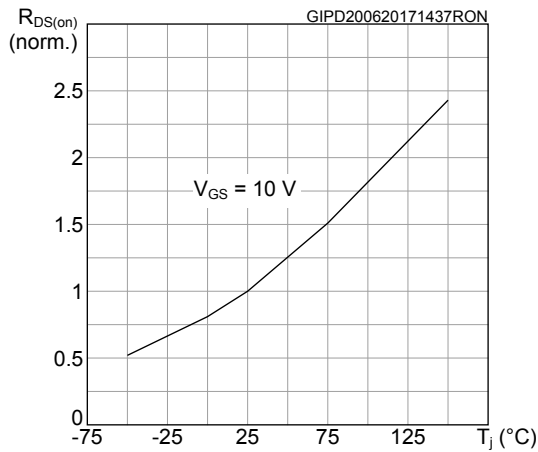

Figure 10. Normalized V_(BR)DSS vs temperature

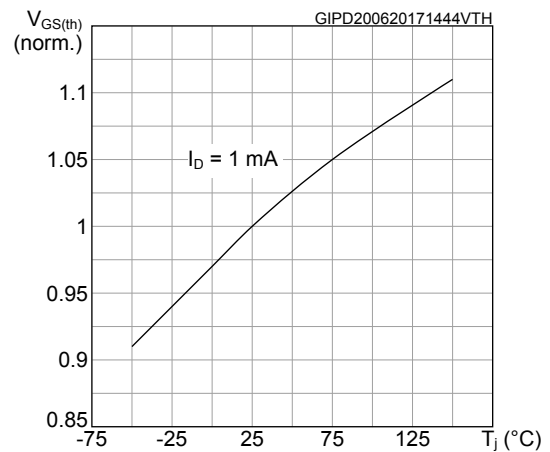

Figure 11. Output capacitance stored energy

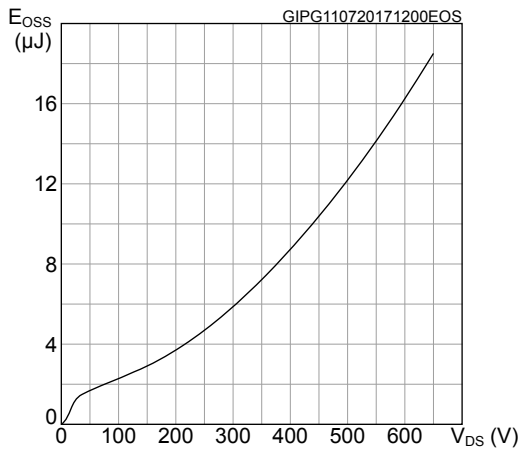
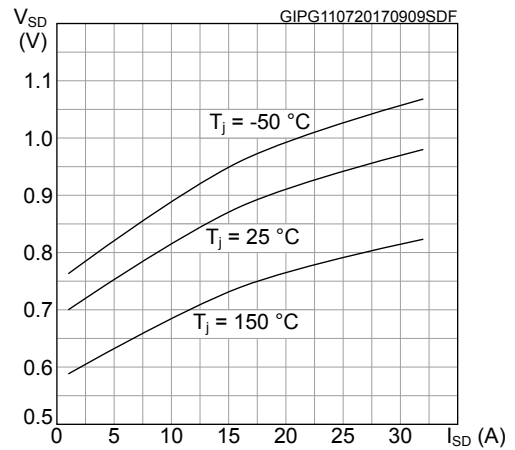
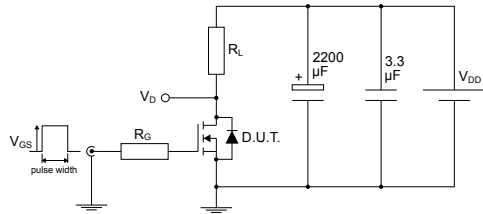

Figure 12. Source-drain diode forward characteristics



3 Test circuits

Figure 13. Test circuit for resistive load switching times

AM01468v1

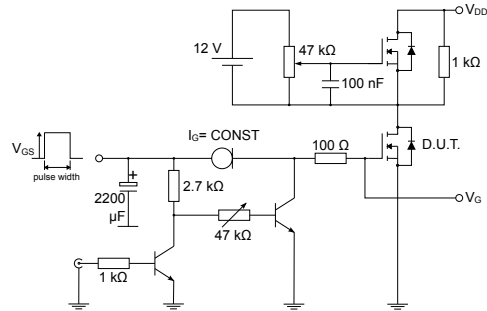
Figure 14. Test circuit for gate charge behavior

AM01469v1

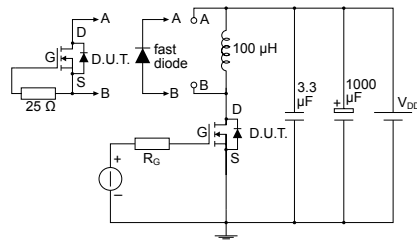
Figure 15. Test circuit for inductive load switching and diode recovery times

AM01470v1

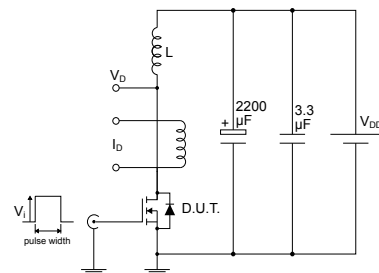
Figure 16. Unclamped inductive load test circuit

AM01471v1

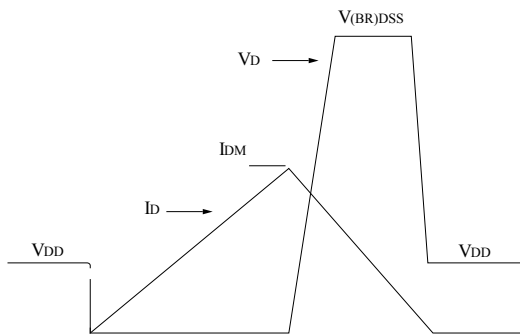
Figure 17. Unclamped inductive waveform

AM01472v1

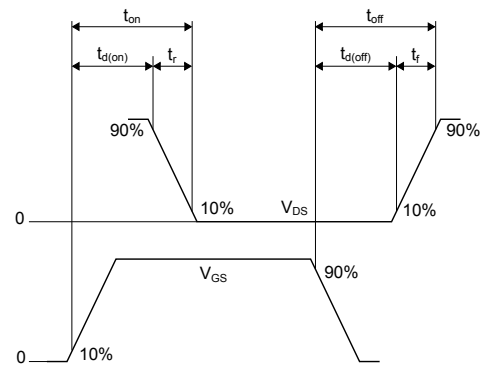
Figure 18. Switching time waveform

AM01473v1

4 Package information

In order to meet environmental requirements, ST offers these devices in different grades of **ECOPACK** packages, depending on their level of environmental compliance. ECOPACK specifications, grade definitions and product status are available at: www.st.com. ECOPACK is an ST trademark.

4.1 TO-247 package information

Figure 19. TO-247 package outline

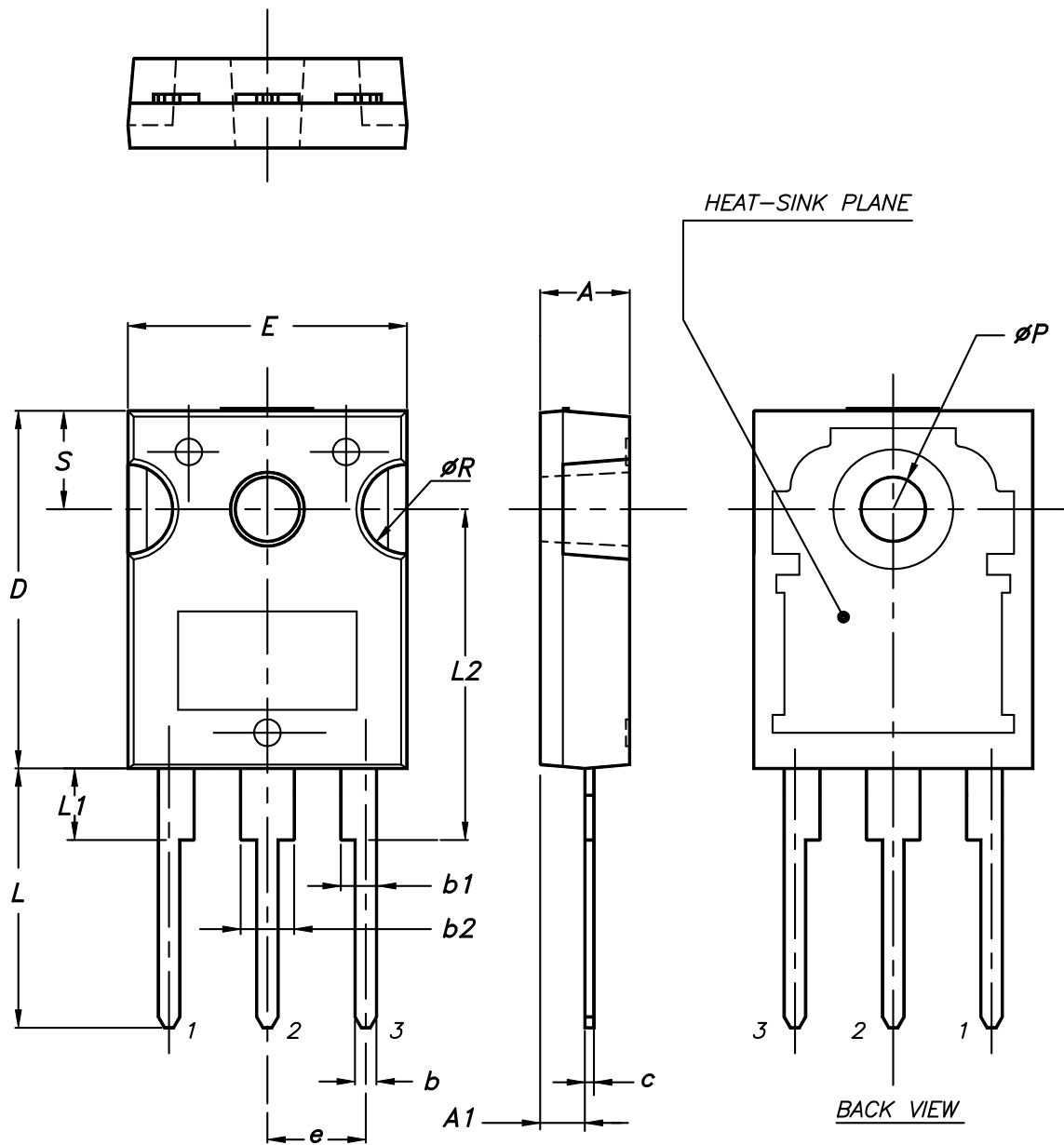

0075325_9

Table 8. TO-247 package mechanical data

Dim.	mm		
	Min.	Typ.	Max.
A	4.85		5.15
A1	2.20		2.60
b	1.0		1.40
b1	2.0		2.40
b2	3.0		3.40
c	0.40		0.80
D	19.85		20.15
E	15.45		15.75
e	5.30	5.45	5.60
L	14.20		14.80
L1	3.70		4.30
L2		18.50	
ØP	3.55		3.65
ØR	4.50		5.50
S	5.30	5.50	5.70

Revision history

Table 9. Document revision history

Date	Revision	Changes
21-Jul-2017	1	Initial release
12-Dec-2017	2	Document status change from preliminary data to production data. Update <i>Table 2: "Absolute maximum ratings"</i> , <i>Table 8: "Source-drain diode"</i> and <i>Figure 2: "Safe operating area"</i> . Minor text changes.
31-Aug-2020	3	Updated <i>Table 1. Absolute maximum ratings</i> . Minor text changes.

Contents

1	Electrical ratings	2
2	Electrical characteristics	3
2.1	Electrical characteristics (curves)	5
3	Test circuits	7
4	Package information	8
4.1	TO-247 package information	8
	Revision history	10

IMPORTANT NOTICE – PLEASE READ CAREFULLY

STMicroelectronics NV and its subsidiaries (“ST”) reserve the right to make changes, corrections, enhancements, modifications, and improvements to ST products and/or to this document at any time without notice. Purchasers should obtain the latest relevant information on ST products before placing orders. ST products are sold pursuant to ST’s terms and conditions of sale in place at the time of order acknowledgement.

Purchasers are solely responsible for the choice, selection, and use of ST products and ST assumes no liability for application assistance or the design of Purchasers’ products.

No license, express or implied, to any intellectual property right is granted by ST herein.

Resale of ST products with provisions different from the information set forth herein shall void any warranty granted by ST for such product.

ST and the ST logo are trademarks of ST. For additional information about ST trademarks, please refer to www.st.com/trademarks. All other product or service names are the property of their respective owners.

Information in this document supersedes and replaces information previously supplied in any prior versions of this document.

© 2020 STMicroelectronics – All rights reserved