

Turbo 2 ultrafast - high voltage rectifier

Main product characteristics

$I_{F(AV)}$	8 A
V_{RRM}	600 V
T_j	175° C
V_F (typ)	1.1 V
t_{rr} (max)	35 ns

Features and benefits

- Ultrafast switching
- Low reverse current
- Low thermal resistance
- Reduces conduction and switching losses
- Insulated package TO-220AC Ins
 - Insulated voltage: 2500 V_{RMS}
 - Typical package capacitance: 7 pF

Description

The STTH806 uses ST Turbo2 600 V technology. This device is specially suited for use in switching power supplies, and industrial applications.

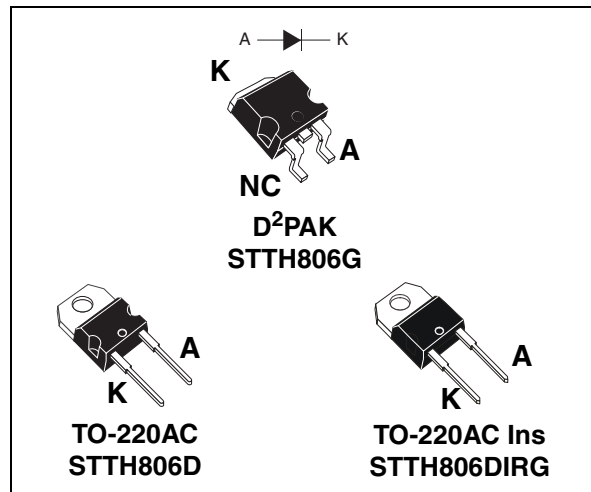

Order codes

Part Number	Marking
STTH806G	STTH806G
STTH806G-TR	STTH806G
STTH806D	STTH806D
STTH806DIRG	STTH806DI

Table 1. Absolute ratings (limiting values per diode at 25° C, unless otherwise specified)

Symbol	Parameter		Value	Unit
V_{RRM}	Repetitive peak reverse voltage		600	V
$I_{F(RMS)}$	RMS forward current	TO-220AC, D ² PAK	30	A
		TO-220 Ins	24	A
$I_{F(AV)}$	Average forward current, $\delta = 0.5$	$T_c = 140^\circ\text{C}$ TO-220AC, D ² PAK	8	A
		$T_c = 120^\circ\text{C}$ TO-220 Ins	8	A
I_{FSM}	Surge non repetitive forward current	$t_p = 10\text{ ms}$ Sinusoidal	90	A
T_{stg}	Storage temperature range		-65 to + 175	°C
T_j	Maximum operating junction temperature ⁽¹⁾		175	°C

1. $\frac{dP_{tot}}{dT_j} < \frac{1}{R_{th(j-a)}}$ condition to avoid thermal runaway for a diode on its own heatsink

1 Characteristics

Table 2. Thermal parameters

Symbol	Parameter		Value	Unit
$R_{th(j-c)}$	Junction to case	TO-220AC, D ² PAK	2.5	°C/W
		TO-220AC Ins	4	

Table 3. Static electrical characteristics

Symbol	Parameter	Test conditions		Min.	Typ	Max.	Unit
$I_R^{(1)}$	Reverse leakage current	$T_j = 25^\circ\text{C}$	$V_R = V_{RRM}$			8	μA
		$T_j = 150^\circ\text{C}$			20	200	
$V_F^{(2)}$	Forward voltage drop	$T_j = 25^\circ\text{C}$	$I_F = 8\text{ A}$			1.85	V
		$T_j = 150^\circ\text{C}$			1.10	1.40	

1. Pulse test: $t_p = 5\text{ ms}$, $\delta < 2\%$

2. Pulse test: $t_p = 380\ \mu\text{s}$, $\delta < 2\%$

To evaluate the conduction losses use the following equation:

$$P = 1.07 \times I_{F(AV)} + 0.041 I_F^2(\text{RMS})$$

Table 4. Dynamic characteristics

Symbol	Parameter	Test conditions	Min.	Typ	Max.	Unit
t_{rr}	Reverse recovery time	$I_F = 0.5\text{ A}$, $I_{rr} = 0.25\text{ A}$, $I_R = 1\text{ A}$, $T_j = 25^\circ\text{C}$			35	ns
		$I_F = 1\text{ A}$, $di_F/dt = -50\text{ A}/\mu\text{s}$, $V_R = 30\text{ V}$, $T_j = 25^\circ\text{C}$		40	55	
I_{RM}	Reverse recovery current	$I_F = 8\text{ A}$, $di_F/dt = -100\text{ A}/\mu\text{s}$, $V_R = 400\text{ V}$, $T_j = 25^\circ\text{C}$		4.5	6.5	
t_{fr}	Forward recovery time	$I_F = 8\text{ A}$ $di_F/dt = 100\text{ A}/\mu\text{s}$ $V_{FR} = 1.1 \times V_{Fmax}$, $T_j = 25^\circ\text{C}$			200	ns
V_{FP}	Forward recovery voltage	$I_F = 8\text{ A}$ $di_F/dt = 100\text{ A}/\mu\text{s}$ $V_{FR} = 1.1 \times V_{Fmax}$, $T_j = 25^\circ\text{C}$		3.5		V

Figure 1. Conduction losses versus average current

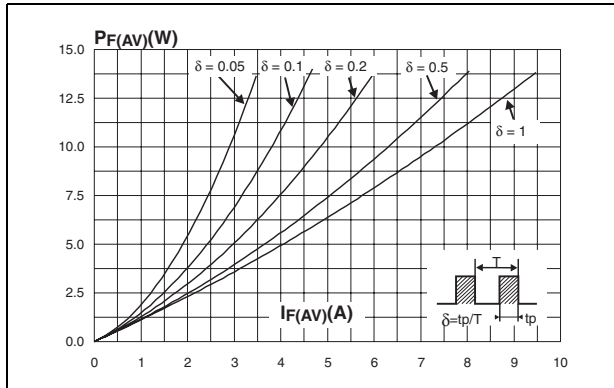

Figure 2. Forward voltage drop versus forward current

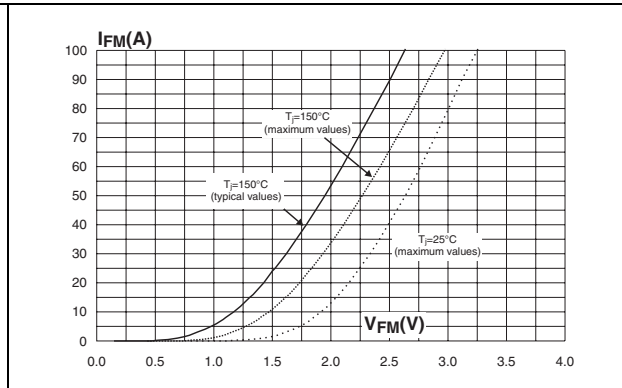

Figure 3. Relative variation of thermal impedance junction to case versus pulse duration

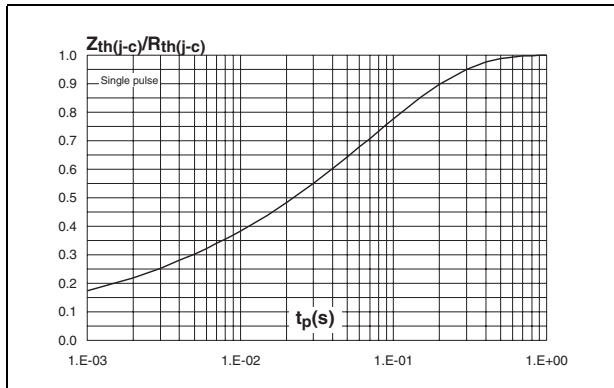

Figure 4. Peak reverse recovery current versus dIF/dt (typical values)

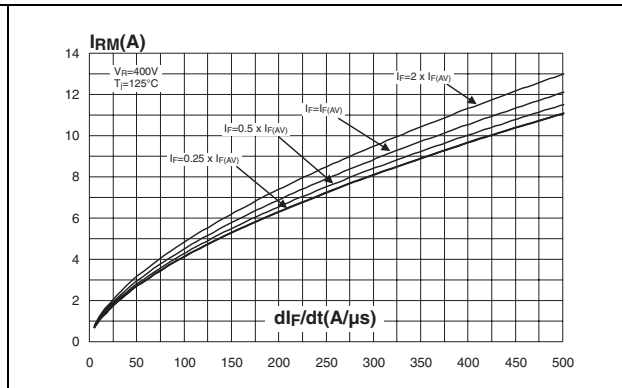

Figure 5. Reverse recovery time versus dIF/dt (typical values)

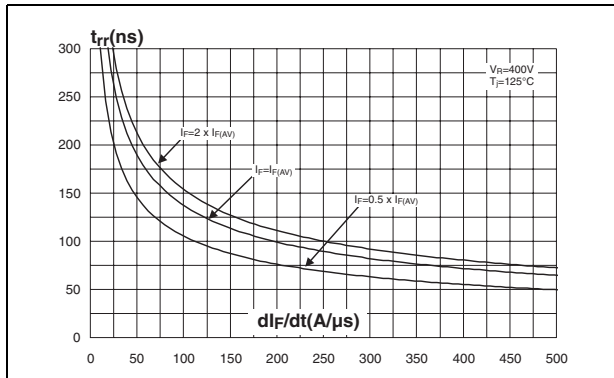

Figure 6. Reverse recovery charges versus dIF/dt (typical values)

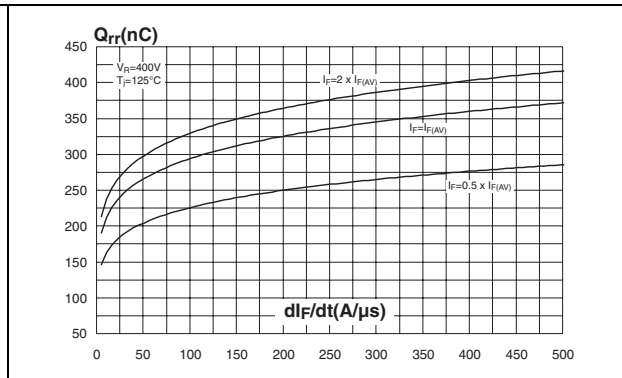

Figure 7. Softness factor versus di_F/dt (typical values)

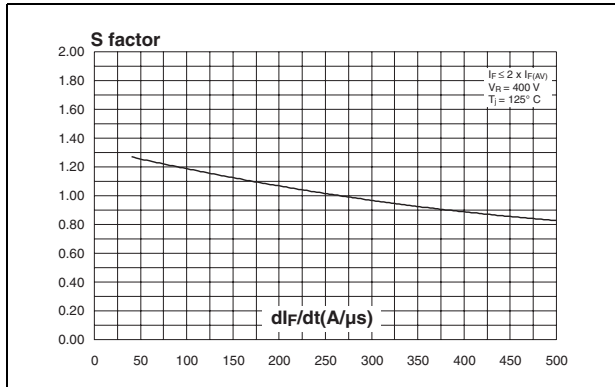

Figure 8. Relative variations of dynamic parameters versus junction temperature

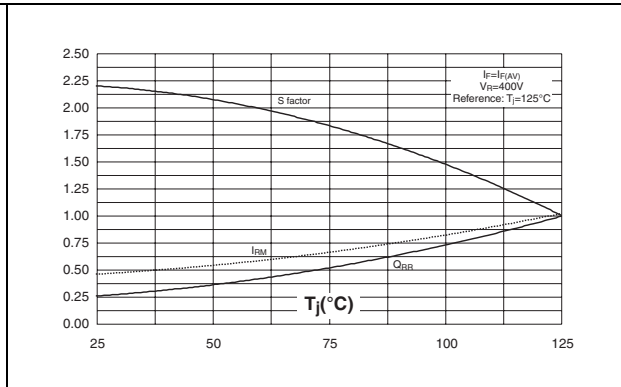

Figure 9. Transient peak forward voltage versus di_F/dt (typical values)

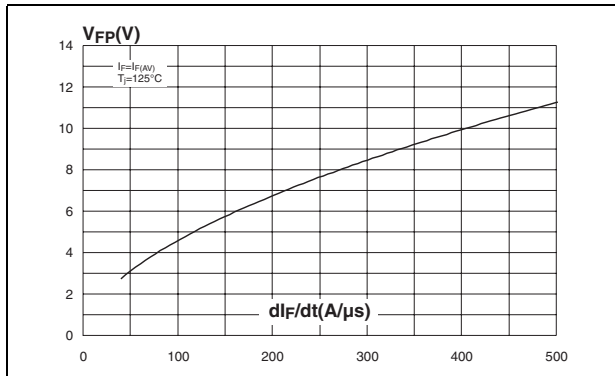

Figure 10. Forward recovery time versus di_F/dt (typical values)

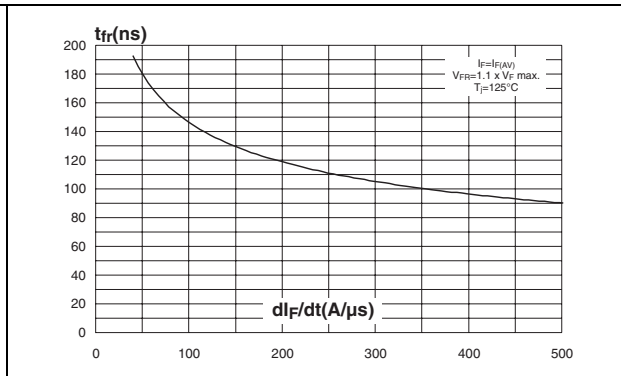

Figure 11. Junction capacitance versus reverse voltage applied (typical values)

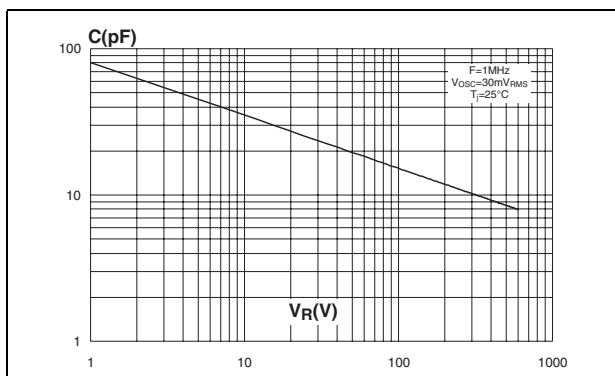
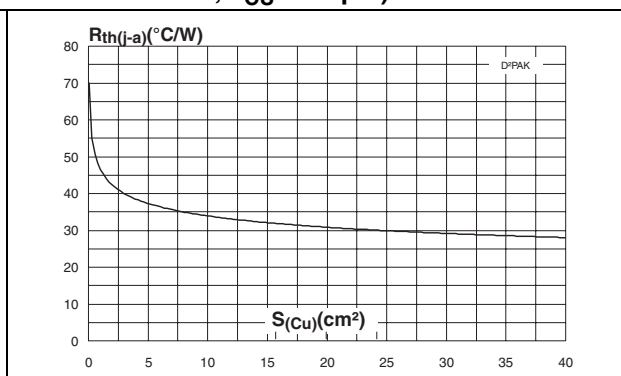

Figure 12. Thermal resistance junction to ambient versus copper surface under tab (printed circuit board FR4, $\epsilon_{CU} = 35 \mu m$)



2 Package mechanical data

Epoxy meets UL94, V0

Cooling method: by conduction (C)

Recommended torque value: 0.80 Nm

Maximum torque value: 1.0 Nm

Table 5. D²PAK Dimensions

Ref.	Dimensions			
	Millimeters		Inches	
	Min.	Max	Min.	Max.
A	4.40	4.60	0.173	0.181
A1	2.49	2.69	0.098	0.106
A2	0.03	0.23	0.001	0.009
B	0.70	0.93	0.027	0.037
B2	1.14	1.70	0.045	0.067
C	0.45	0.60	0.017	0.024
C2	1.23	1.36	0.048	0.054
D	8.95	9.35	0.352	0.368
E	10.00	10.40	0.393	0.409
G	4.88	5.28	0.192	0.208
L	15.00	15.85	0.590	0.624
L2	1.27	1.40	0.050	0.055
L3	1.40	1.75	0.055	0.069
M	2.40	3.20	0.094	0.126
R	0.40 typ.		0.016 typ.	
V2	0°	8°	0°	8°

Figure 13. D²PAK Footprint dimensions (in mm)

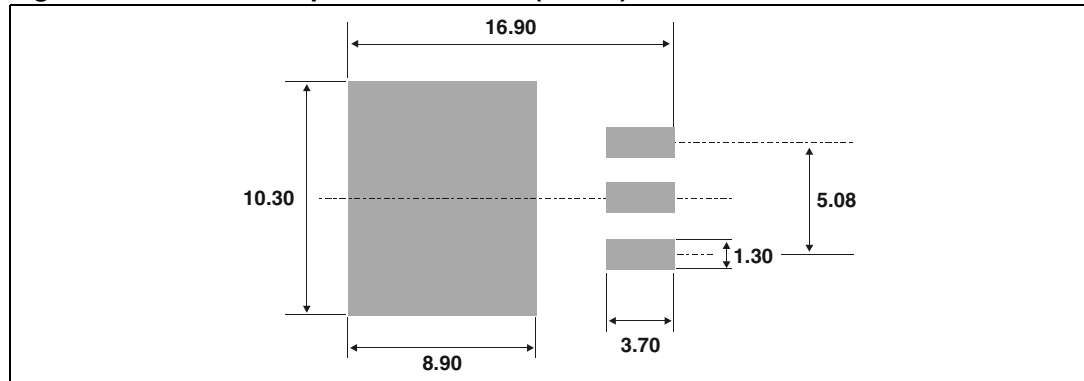
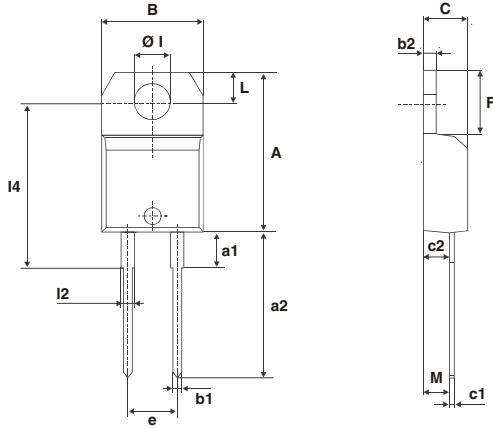

Table 6. TO-220AC Dimensions

Ref.	Dimensions			
	Millimeters		Inches	
	Min.	Max.	Min.	Max.
A	4.40	4.60	0.173	0.181
C	1.23	1.32	0.048	0.051
D	2.40	2.72	0.094	0.107
E	0.49	0.70	0.019	0.027
F	0.61	0.88	0.024	0.034
F1	1.14	1.70	0.044	0.066
G	4.95	5.15	0.194	0.202
H2	10.00	10.40	0.393	0.409
L2	16.40 typ.		0.645 typ.	
L4	13.00	14.00	0.511	0.551
L5	2.65	2.95	0.104	0.116
L6	15.25	15.75	0.600	0.620
L7	6.20	6.60	0.244	0.259
L9	3.50	3.93	0.137	0.154
M	2.6 typ.		0.102 typ.	
Diam. I	3.75	3.85	0.147	0.151

Table 7. TO-220AC Ins Dimensions



Ref.	Dimensions					
	Millimeters			Inches		
	Min.	Typ.	Max.	Min.	Typ.	Max.
A	15.20		15.90	0.598		0.625
a1		3.75			0.147	
a2	13.00		14.00	0.511		0.551
B	10.00		10.40	0.393		0.409
b1	0.61		0.88	0.024		0.034
b2	1.23		1.32	0.048		0.051
C	4.40		4.60	0.173		0.181
c1	0.49		0.70	0.019		0.027
c2	2.40		2.72	0.094		0.107
e	4.80		5.40	0.189		0.212
F	6.20		6.60	0.244		0.259
Ø1	3.75		3.85	0.147		0.151
I4	15.80	16.40	16.80	0.622	0.646	0.661
L	2.65		2.95	0.104		0.116
I2	1.14		1.70	0.044		0.066
M		2.60			0.102	

In order to meet environmental requirements, ST offers these devices in ECOPACK® packages. These packages have a lead-free second level interconnect. The category of second level interconnect is marked on the package and on the inner box label, in compliance with JEDEC Standard JESD97. The maximum ratings related to soldering conditions are also marked on the inner box label. ECOPACK is an ST trademark. ECOPACK specifications are available at: www.st.com.

3 Ordering information

Part Number	Marking	Package	Weight	Base qty	Delivery mode
STTH806G	STTH806G	D ² PAK	1.48 g	50	Tube
STTH806G-TR	STTH806G	D ² PAK	1.48 g	1000	Tape and reel
STTH806D	STTH806D	TO-220AC	1.90 g	50	Tube
STTH806DIRG	STTH806DI	TO-220AC Ins	2.30 g	50	Tube

4 Revision history

Date	Revision	Description of Changes
18-May-2006	1	First issue.
10-Aug-2006	2	Changed part number STTH806DI to STTH806DIRG.

Please Read Carefully:

Information in this document is provided solely in connection with ST products. STMicroelectronics NV and its subsidiaries ("ST") reserve the right to make changes, corrections, modifications or improvements, to this document, and the products and services described herein at any time, without notice.

All ST products are sold pursuant to ST's terms and conditions of sale.

Purchasers are solely responsible for the choice, selection and use of the ST products and services described herein, and ST assumes no liability whatsoever relating to the choice, selection or use of the ST products and services described herein.

No license, express or implied, by estoppel or otherwise, to any intellectual property rights is granted under this document. If any part of this document refers to any third party products or services it shall not be deemed a license grant by ST for the use of such third party products or services, or any intellectual property contained therein or considered as a warranty covering the use in any manner whatsoever of such third party products or services or any intellectual property contained therein.

UNLESS OTHERWISE SET FORTH IN ST'S TERMS AND CONDITIONS OF SALE ST DISCLAIMS ANY EXPRESS OR IMPLIED WARRANTY WITH RESPECT TO THE USE AND/OR SALE OF ST PRODUCTS INCLUDING WITHOUT LIMITATION IMPLIED WARRANTIES OF MERCHANTABILITY, FITNESS FOR A PARTICULAR PURPOSE (AND THEIR EQUIVALENTS UNDER THE LAWS OF ANY JURISDICTION), OR INFRINGEMENT OF ANY PATENT, COPYRIGHT OR OTHER INTELLECTUAL PROPERTY RIGHT.

UNLESS EXPRESSLY APPROVED IN WRITING BY AN AUTHORIZED ST REPRESENTATIVE, ST PRODUCTS ARE NOT RECOMMENDED, AUTHORIZED OR WARRANTED FOR USE IN MILITARY, AIR CRAFT, SPACE, LIFE SAVING, OR LIFE SUSTAINING APPLICATIONS, NOR IN PRODUCTS OR SYSTEMS WHERE FAILURE OR MALFUNCTION MAY RESULT IN PERSONAL INJURY, DEATH, OR SEVERE PROPERTY OR ENVIRONMENTAL DAMAGE. ST PRODUCTS WHICH ARE NOT SPECIFIED AS "AUTOMOTIVE GRADE" MAY ONLY BE USED IN AUTOMOTIVE APPLICATIONS AT USER'S OWN RISK.

Resale of ST products with provisions different from the statements and/or technical features set forth in this document shall immediately void any warranty granted by ST for the ST product or service described herein and shall not create or extend in any manner whatsoever, any liability of ST.

ST and the ST logo are trademarks or registered trademarks of ST in various countries.

Information in this document supersedes and replaces all information previously supplied.

The ST logo is a registered trademark of STMicroelectronics. All other names are the property of their respective owners.

© 2006 STMicroelectronics - All rights reserved

STMicroelectronics group of companies

Australia - Belgium - Brazil - Canada - China - Czech Republic - Finland - France - Germany - Hong Kong - India - Israel - Italy - Japan - Malaysia - Malta - Morocco - Singapore - Spain - Sweden - Switzerland - United Kingdom - United States of America

www.st.com