



SMA3103

MMIC

Amplifier, 5V, 19mA, 0.1 to 3.3GHz, MCPH6

ON Semiconductor®

<http://onsemi.com>

Features

- High Gain : $G_p=26.5\text{dB typ. @1GHz}$
- Wideband response : $f_u=3.3\text{GHz}$
- Low current : $I_{CC}=19\text{mA typ}$
- High output power : $P_o(1\text{dB})=5\text{dBm}$
- Port impedance : input/output 50Ω

Specifications

Absolute Maximum Ratings at $T_a=25^\circ\text{C}$

Parameter	Symbol	Conditions	Ratings	Unit
Supply Voltage	V_{CC}		6	V
Circuit Current	I_{CC}		40	mA
Allowable Power Dissipation	P_D		280	mW
Operating Temperature	T_{opr}		-40 to +85	$^\circ\text{C}$
Storage Temperature	T_{stg}		-55 to +150	$^\circ\text{C}$

Stresses exceeding Maximum Ratings may damage the device. Maximum Ratings are stress ratings only. Functional operation above the Recommended Operating Conditions is not implied. Extended exposure to stresses above the Recommended Operating Conditions may affect device reliability.

Package Dimensions

unit : mm (typ)

7022A-018

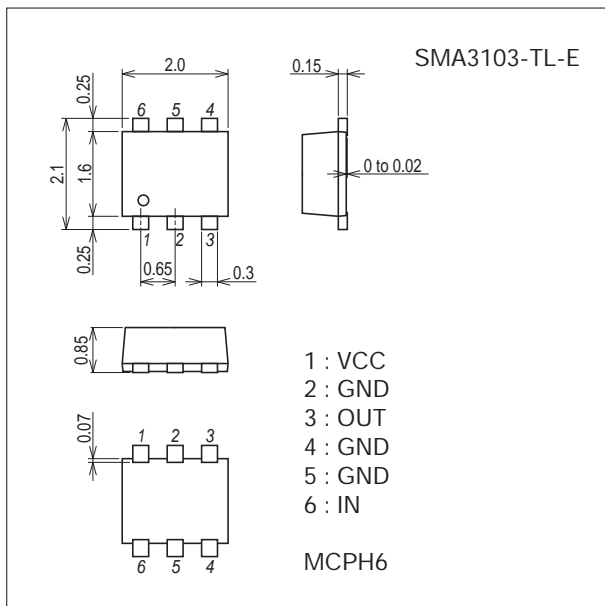

Product & Package Information

- Package : MCPH6
- JEITA, JEDEC : SC-88, SC-70-6, SOT-363
- Minimum Packing Quantity : 3,000 pcs./reel

Packing Type : TL

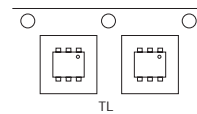

Marking

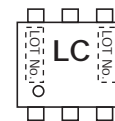

SMA3103

Recommended Operating Condition at Ta=25°C

Parameter	Symbol	Conditions	Ratings			Unit
			min	typ	max	
Supply Voltage	VCC		4.5	5	5.5	V
Operating Ambient Temperature	Topr		-40	+25	+85	°C

Note) Pay attention to handling since it is liable to be affected by static electricity due to the high frequency process adopted.

Electrical Characteristics at Ta=25°C, VCC=5V, Zs=ZL=50Ω

Parameter	Symbol	Conditions	Ratings			Unit
			min	typ	max	
Circuit Current	ICC		14.0	19.0	25.0	mA
Power Gain	Gp	f=1GHz	24.0	26.5	29.0	dB
		f=2.2GHz	24.0	27.0	30.0	
Isolation	ISL	f=1GHz	31.0	33.0		dB
		f=2.2GHz	31.0	33.0		
Input Return Loss	RLin	f=1GHz	12.0	20.0		dB
		f=2.2GHz	10.0	14.0		
Output Return Loss	RLout	f=1GHz	12.0	20.0		dB
		f=2.2GHz	10.0	16.0		
Noise Figure	NF	f=1GHz		4.7	5.3	dB
		f=2.2GHz		4.7	5.3	
Gain 1dB Compression Output Power	Po(1dB)	f=1GHz	6.0	8.2		dBm
		f=2.2GHz	4.0	5.7		
Upper Limit Operating Frequency	fu	3dB down below flat gain at f =1GHz		3.3		GHz

Ordering Information

Device	Package	Shipping	memo
SMA3103-TL-E	MCPH6	3,000pcs./reel	Pb Free

SMA3103

Test Circuit

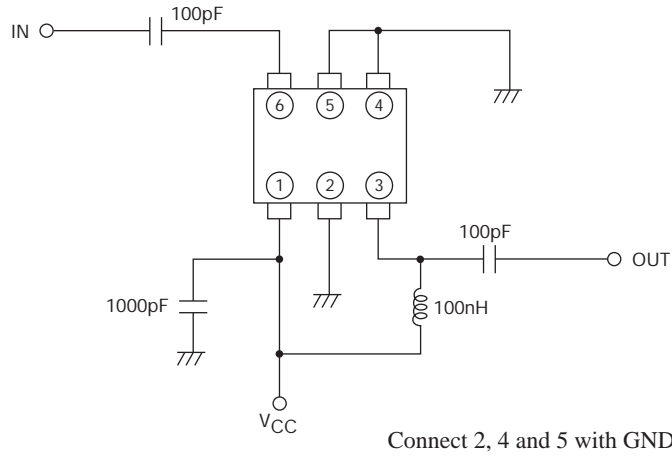

Design of the Evaluation Board

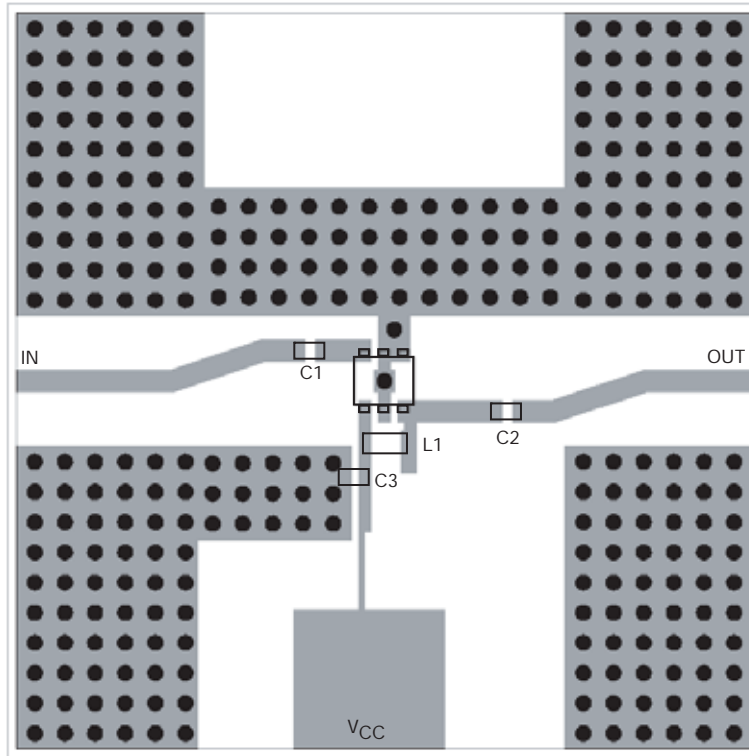

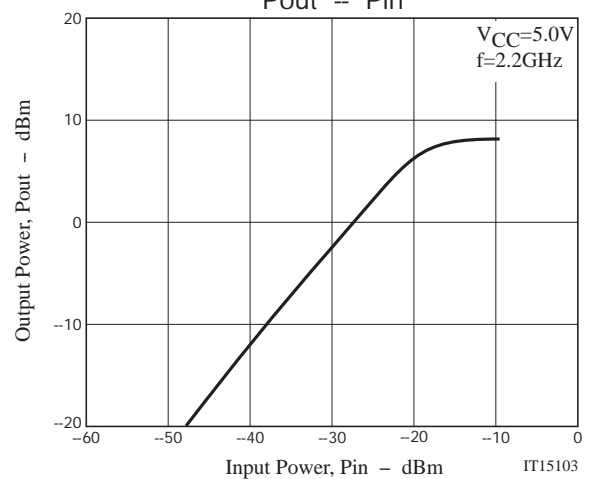
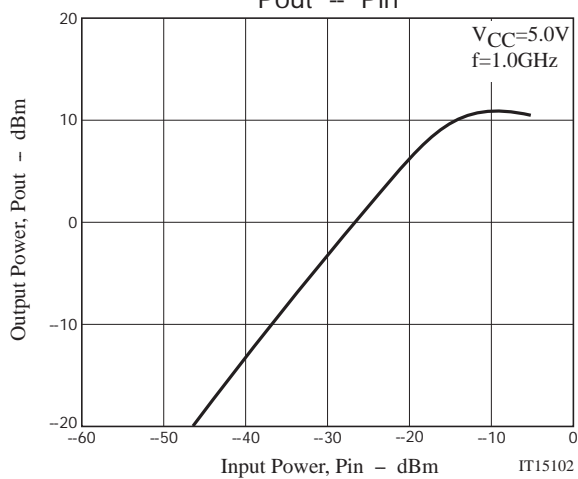
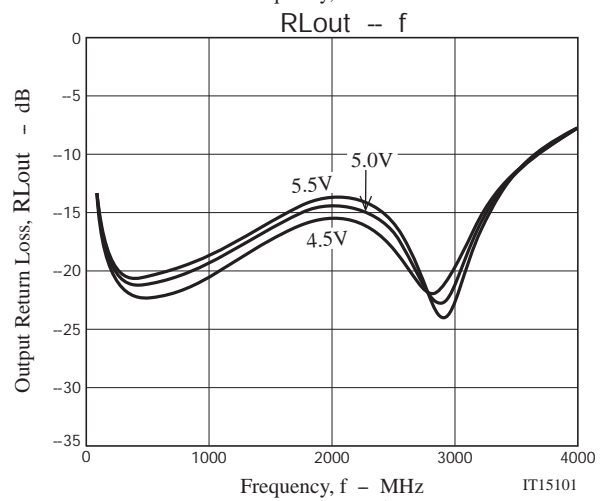
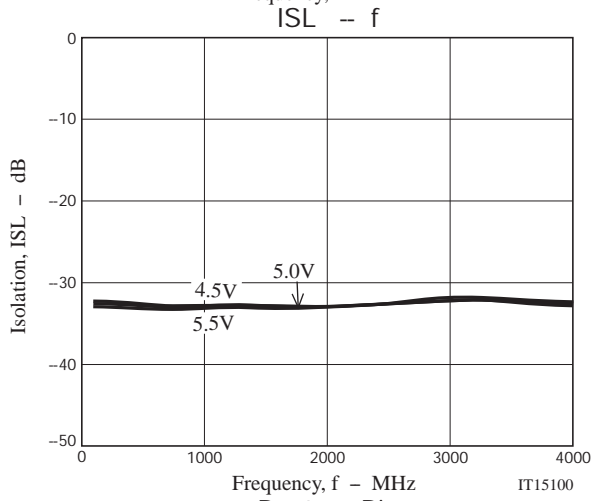
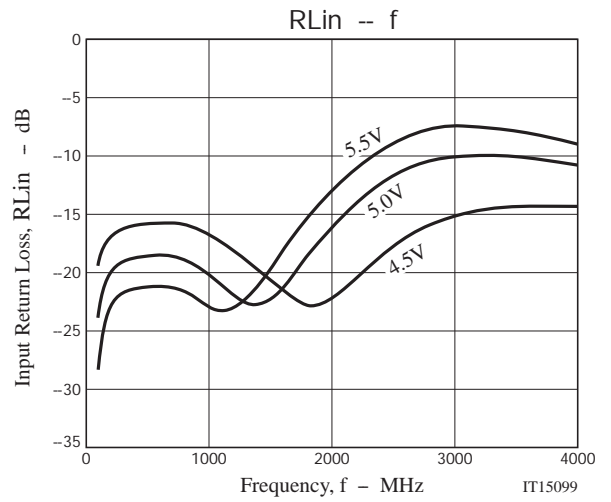
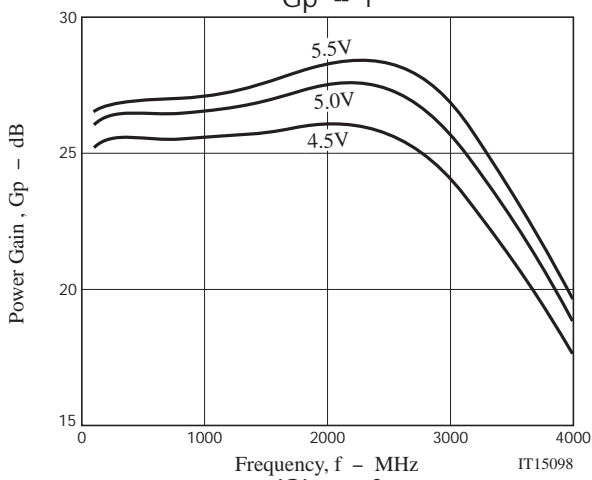
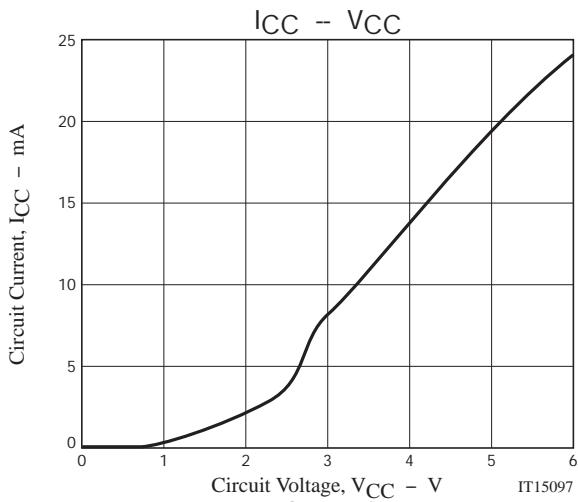

SMA3103

S Parameter
S11

S22

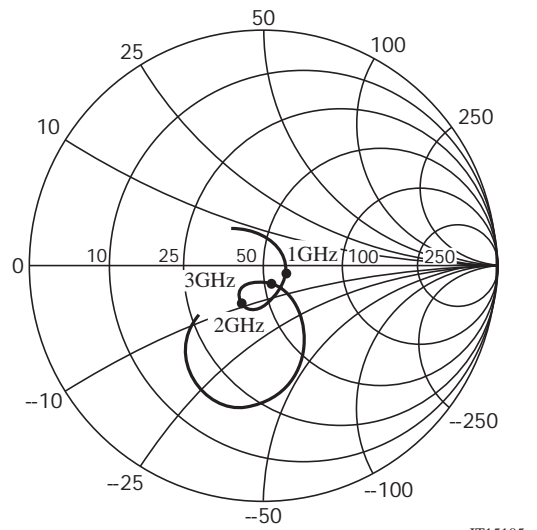
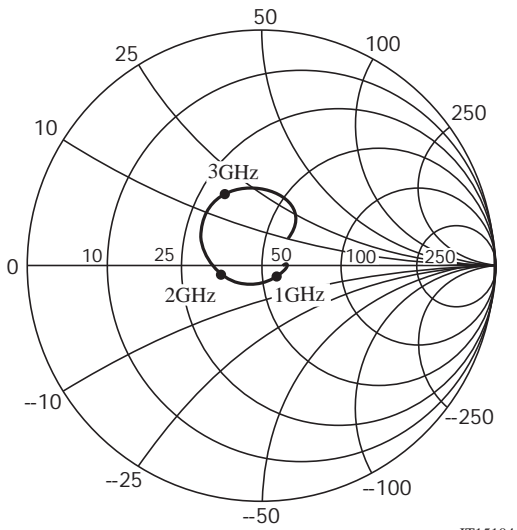

SMA3103

Embossed Taping Specification

SMA3103-TL-E

1. Packing Format

Package Name	Carrier Tape Type	Maximum Number of devices contained (pcs)			Packing format	
		Reel	Inner box	Outer box	Inner BOX (C-1)	Outer BOX (A-7)
MCPH6	MCP4	3,000	15,000	90,000	5 reels contained Dimensions:mm (external) 183×72×185	6 inner boxes contained Dimensions:mm (external) 440×195×210

Packing method

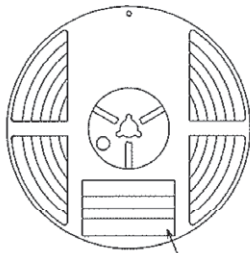

Type No.
LOT No.
Quantity
Origin

Reel label

Reel label, Inner box label
(unit :mm)

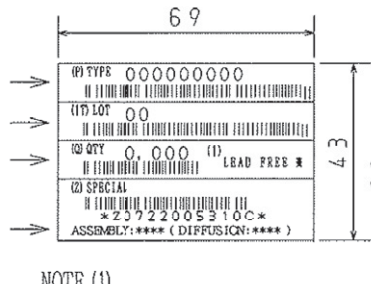

Outer box label

It is a label at the time of factory shipments. The form of a label may change in physical distribution process.

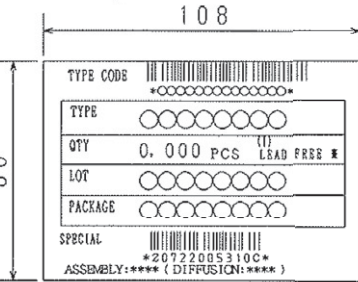

NOTE (1)

The LEAD FREE * description shows that the surface treatment of the terminal is lead free.

Label	JEITA Phase
LEAD FREE 3	JEITA Phase 3A
LEAD FREE 4	JEITA Phase 3

2. Taping configuration

2-1. Carrier tape size (unit:mm)

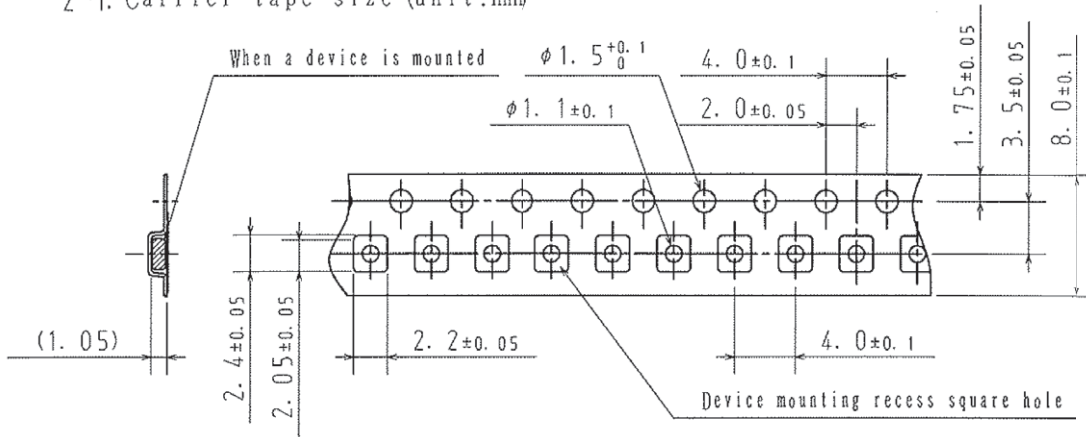

2-2. Device placement direction

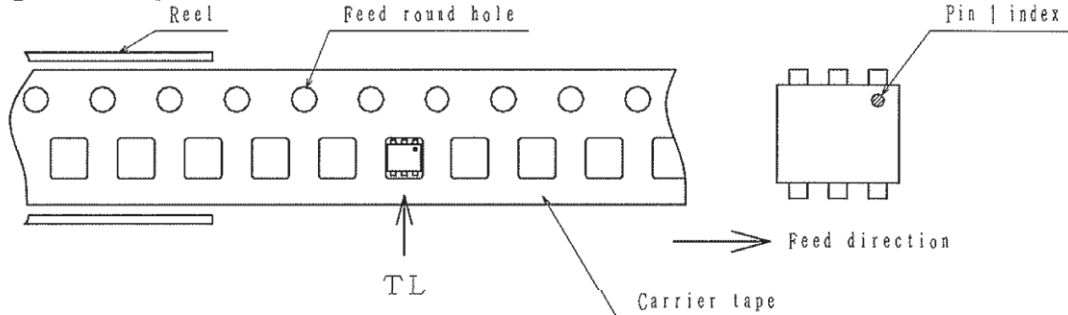

Those with pin | index on the feed hole side.....TL

SMA3103

Outline Drawing SMA3103-TL-E

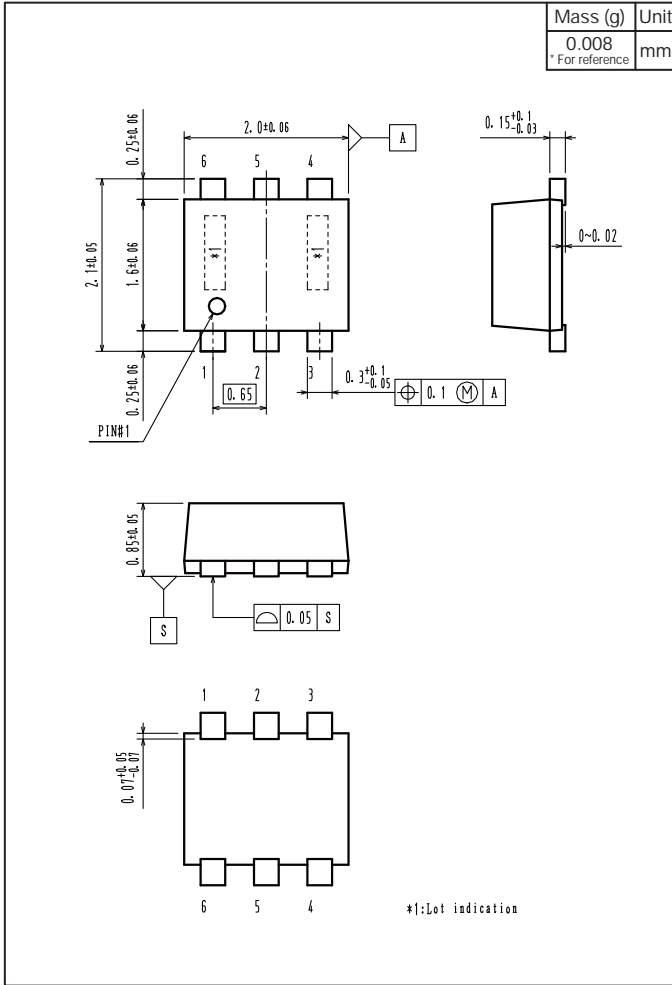

Land Pattern Example

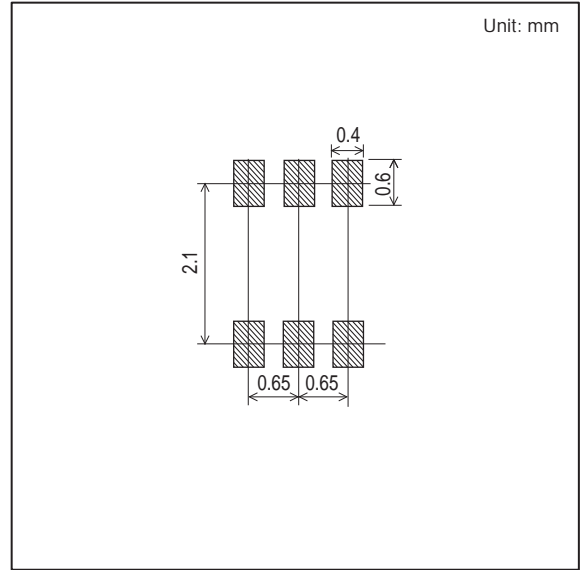

ON Semiconductor and the ON logo are registered trademarks of Semiconductor Components Industries, LLC (SCILLC). SCILLC owns the rights to a number of patents, trademarks, copyrights, trade secrets, and other intellectual property. A listing of SCILLC's product/patent coverage may be accessed at www.onsemi.com/site/pdf/Patent-Marking.pdf. SCILLC reserves the right to make changes without further notice to any products herein. SCILLC makes no warranty, representation or guarantee regarding the suitability of its products for any particular purpose, nor does SCILLC assume any liability arising out of the application or use of any product or circuit, and specifically disclaims any and all liability, including without limitation special, consequential or incidental damages. "Typical" parameters which may be provided in SCILLC data sheets and/or specifications can and do vary in different applications and actual performance may vary over time. All operating parameters, including "Typicals" must be validated for each customer application by customer's technical experts. SCILLC does not convey any license under its patent rights nor the rights of others. SCILLC products are not designed, intended, or authorized for use as components in systems intended for surgical implant into the body, or other applications intended to support or sustain life, or for any other application in which the failure of the SCILLC product could create a situation where personal injury or death may occur. Should Buyer purchase or use SCILLC products for any such unintended or unauthorized application, Buyer shall indemnify and hold SCILLC and its officers, employees, subsidiaries, affiliates, and distributors harmless against all claims, costs, damages, and expenses, and reasonable attorney fees arising out of, directly or indirectly, any claim of personal injury or death associated with such unintended or unauthorized use, even if such claim alleges that SCILLC was negligent regarding the design or manufacture of the part. SCILLC is an Equal Opportunity/Affirmative Action Employer. This literature is subject to all applicable copyright laws and is not for resale in any manner.