

SONET/SDH PRECISION CLOCK MULTIPLIER IC

Features

- Ultra-low jitter clock output with jitter generation as low as 0.3 ps_{RMS}
- No external components (other than a resistor and bypassing)
- Input clock ranges at 19, 39, 78, 155, 311, or 622 MHz
- Output clock ranges at 19, 39, 78, 155, 311, 622, 1244, or 2488 MHz
- Maximum range includes 693 MHz for 10 GbE FEC support
- Digital hold for loss-of-input clock
- Support for 255/238 (15/14), 255/237 (85/79), and 66/64 FEC scaling (ITU-T G.709 and IEEE 802.3ae)
- Selectable loop bandwidth
- Loss-of-signal alarm output
- Low power
- Small size (9 x 9 mm)
- Backwards compatible with Si5320

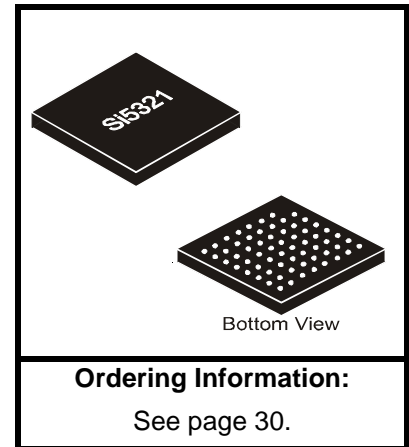

Applications

- SONET/SDH line/port cards
- Terabit routers
- Core switches
- Digital cross connects

Description

The Si5321 is a precision clock multiplier that exceeds the requirements of high-speed communication systems, including OC-192/OC-48 and 10 Gigabit Ethernet. This device phase locks to an input clock in the 19, 39, 78, 155, 311 or 622 MHz frequency range and generates a frequency-multiplied clock output that can be configured for operation in the 19, 39, 78, 155, 622, 1244, or 2488 MHz frequency range. Skyworks Solutions DSPLL® technology provides PLL functionality with unparalleled performance. It eliminates external loop filter components, provides programmable loop parameters, and simplifies design. FEC rates are supported by selectable forward and reverse 255/238 (15/14), 255/237 (85/79), and 66/64 (33/32) conversion factors. The ITU-T G.709 255/237 rate and the IEEE 802.3ae 66/64 rate are supported when using a 155 MHz or higher rate input clock. The performance and integration of Skyworks Solutions' Si5321 clock IC provides high-level support of the latest specifications and systems. It operates from a single 3.3 V supply.

Functional Block Diagram

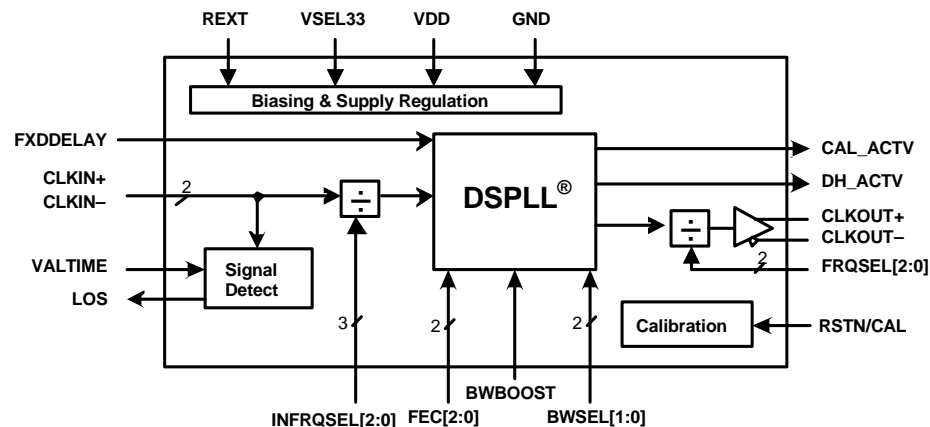

TABLE OF CONTENTS

<u>Section</u>	<u>Page</u>
1. Electrical Specifications	4
2. Functional Description	17
2.1. DSPLL [®]	17
2.2. Clock Input and Output Rate Selection	17
2.3. PLL Performance	19
2.4. Loss-of-Signal Alarm	19
2.5. Digital Hold of the PLL	20
2.6. Hitless Recovery from Digital Hold	20
2.7. Reset	20
2.8. PLL Self-Calibration	20
2.9. Bias Generation Circuitry	21
2.10. Differential Input Circuitry	21
2.11. Differential Output Circuitry	21
2.12. Power Supply Connections	21
2.13. Design and Layout Guidelines	22
3. Pin Descriptions: Si5321	23
4. Ordering Guide	30
5. Package Outline	31
6. 9x9 mm PBGA Card Layout	32
Document Change List	33
Contact Information	34

Si5321

1. Electrical Specifications

Table 1. Recommended Operating Conditions

Parameter	Symbol	Test Condition	Min ¹	Typ	Max ¹	Unit
Ambient Temperature	T _A		-20 ²	25	85	°C
Si5321 Supply Voltage ³ , 3.3 V Supply	V _{DD33}		3.135	3.3	3.465	V

Notes:

1. All minimum and maximum specifications are guaranteed and apply across the recommended operating conditions. Typical values apply at nominal supply voltages and an operating temperature of 25 °C unless otherwise stated.
2. The Si5321 is guaranteed by design to operate at -40° C. All electrical specifications are guaranteed for an ambient temperature of -20 to 85° C.
3. The Si5321 specifications are guaranteed when using the recommended application circuit (including component tolerance) of Figure 5 on page 16.

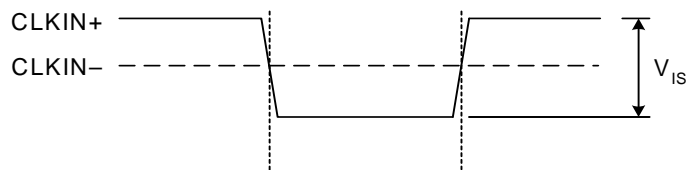

A. Operation with Single-Ended Clock Input*

Note: When using single-ended clock sources, the unused clock input on the Si5321 must be ac-coupled to ground.

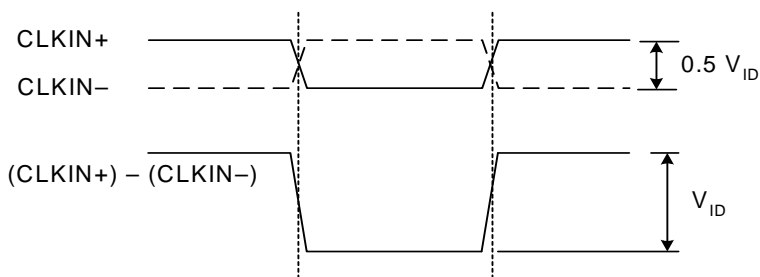

B. Operation with Differential Clock Input

Note: Transmission line termination, when required, must be provided externally.

Figure 1. CLKIN Voltage Characteristics

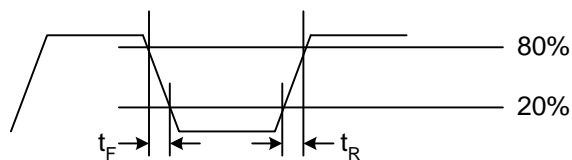

Figure 2. Rise/Fall Time Measurement

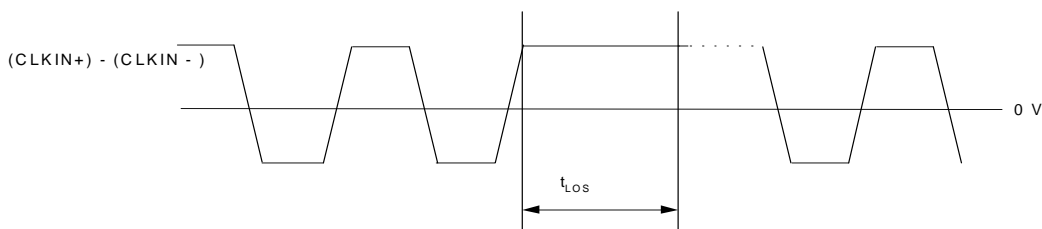

Figure 3. Transitionless Period on CLKIN for Detecting a LOS Condition

Si5321

Table 2. DC Characteristics, $V_{DD} = 3.3\text{ V}$

($V_{DD33} = 3.3\text{ V} \pm 5\%$, $T_A = -20\text{ to }85\text{ }^\circ\text{C}$)

Parameter	Symbol	Test Condition	Min	Typ	Max	Unit
Supply Current 1	I_{DD}	622.08 MHz In, 19.44 MHz Out	—	141	155	mA
Supply Current 2	I_{DD}	19.44 MHz In, 622.08 MHz Out	—	135	145	mA
Power Dissipation Using 3.3 V Supply Clock Output	P_D	19.44 MHz In, 622.08 MHz Out	—	445	479	mW
Common Mode Input Voltage ^{1,2,3} (CLKIN)	V_{ICM}		1.0	1.5	2.0	V
Single-Ended Input Voltage ^{2,3,4} (CLKIN)	V_{IS}	See Figure 1A	200	—	500 ⁴	mV _{PP}
Differential Input Voltage Swing ^{2,3,4} (CLKIN)	V_{ID}	See Figure 1B	200	—	500 ⁴	mV _{PP}
Input Impedance (CLKIN+, CLKIN–)	R_{IN}		—	80	—	k Ω
Differential Output Voltage Swing (CLKOUT)	V_{OD}	100 Ω Load Line-to-Line, FRQSEL[0:2] = 011	750	825	1100	mV _{PP}
Output Common Mode Voltage (CLKOUT)	V_{OCM}	100 Ω Load Line-to-Line	1.4	1.8	2.2	V
Output Short to GND (CLKOUT)	$I_{SC(-)}$		–60	—	—	mA
Output Short to V_{DD25} (CLKOUT)	$I_{SC(+)}$		—	15	—	mA
Input Voltage Low (LVTTTL Inputs)	V_{IL}		—	—	0.8	V
Input Voltage High (LVTTTL Inputs)	V_{IH}		2.0	—	—	V
Input Low Current (LVTTTL Inputs)	I_{IL}		—	—	50	μA
Input High Current (LVTTTL Inputs)	I_{IH}		—	—	50	μA
Internal Pulldowns (LVTTTL Inputs)	I_{pd}		—	—	50	μA
Input Impedance (LVTTTL Inputs)	R_{IN}		50	—	—	k Ω
Output Voltage Low (LVTTTL Outputs)	V_{OL}	$I_O = 0.5\text{ mA}$	—	—	0.4	V
Output Voltage High (LVTTTL Outputs)	V_{OH}	$I_O = 0.5\text{ mA}$	2.0	—	—	V

Notes:

1. The Si5321 device provides weak 1.5 V internal biasing that enables ac-coupled operation.
2. Clock inputs may be driven differentially or single-endedly. When driven single-endedly, the unused input should be ac-coupled to ground.
3. Transmission line termination, when required, must be provided externally.
4. Although the Si5321 device can operate with input clock swings as high as 1500 mV_{PP}, Skyworks Solutions recommends maintaining the input clock amplitude below 500 mV_{PP} for optimal performance.

Table 3. AC Characteristics $(V_{DD33} = 3.3\text{ V} \pm 5\%, T_A = -20\text{ to } 85\text{ }^\circ\text{C})$

Parameter	Symbol	Test Condition	Min	Typ	Max	Unit
Input Clock Frequency (CLKIN) FEC[2:0] = 000 (non FEC) INFRQSEL[2:0] = 001 INFRQSEL[2:0] = 010 INFRQSEL[2:0] = 011 INFRQSEL[2:0] = 100 INFRQSEL[2:0] = 101 INFRQSEL[2:0] = 110	f_{CLKIN}	No FEC Scaling, FXDDELAY = 1	19.436 38.872 77.744 155.48 310.97 621.95	— — — — — —	21.685 43.369 86.738 173.48 346.95 693.90	MHz
Input Clock Frequency (CLKIN) FEC[2:0] = 001 (forward FEC) INFRQSEL[2:0] = 001 INFRQSEL[2:0] = 010 INFRQSEL[2:0] = 011 INFRQSEL[2:0] = 100 INFRQSEL[2:0] = 101 INFRQSEL[2:0] = 110	f_{CLKIN}	255/238 FEC Scaling, FXDDELAY = 1	18.142 36.284 72.568 145.13 290.27 580.54	— — — — — —	20.239 40.478 80.955 161.91 323.82 647.64	MHz
Input Clock Frequency (CLKIN) FEC[2:0] = 010 (reverse FEC) INFRQSEL[2:0] = 001 INFRQSEL[2:0] = 010 INFRQSEL[2:0] = 011 INFRQSEL[2:0] = 100 INFRQSEL[2:0] = 101 INFRQSEL[2:0] = 110	f_{CLKIN}	238/255 FEC Scaling, FXDDELAY = 1	20.826 41.652 83.305 166.61 333.22 666.44	— — — — — —	23.234 46.465 92.934 185.87 371.74 743.47	MHz
Input Clock Frequency (CLKIN) FEC[2:0] = 100 (forward FEC) INFRQSEL[2:0] = 001 INFRQSEL[2:0] = 010 INFRQSEL[2:0] = 011 INFRQSEL[2:0] = 100 INFRQSEL[2:0] = 101 INFRQSEL[2:0] = 110	f_{CLKIN}	255/237 FEC Scaling Minimum input frequency is in the 155 MHz range, FXDDELAY = 1	N/A N/A N/A 144.52 289.05 578.11	N/A N/A N/A — — —	N/A N/A N/A 161.23 322.46 644.92	MHz
Input Clock Frequency (CLKIN) FEC[2:0] = 101 (reverse FEC) INFRQSEL[2:0] = 001 INFRQSEL[2:0] = 010 INFRQSEL[2:0] = 011 INFRQSEL[2:0] = 100 INFRQSEL[2:0] = 101 INFRQSEL[2:0] = 110	f_{CLKIN}	237/255 FEC Scaling Minimum input frequency is in the 155 MHz range, FXDDELAY = 1	N/A N/A N/A 167.31 334.62 669.25	N/A N/A N/A — — —	N/A N/A N/A 186.66 373.31 746.61	MHz
Note: The Si5321 provides a 1/32x, 1/16x, 1/8x, 1/4x, 1/2x, 1x, 2x, 4x, 8x, 16x, 32x, 64x, or 128x clock multiplication function with an option for additional frequency scaling by a factor of 255/238, 238/255, 255/237, 237/255, 66/64, or 64/66 for FEC rate conversion.						

Table 3. AC Characteristics (Continued) $(V_{DD33} = 3.3\text{ V} \pm 5\%, T_A = -20\text{ to }85\text{ }^\circ\text{C})$

Parameter	Symbol	Test Condition	Min	Typ	Max	Unit
Input Clock Frequency (CLKIN) FEC[2:0] = 110 (forward FEC) INFRQSEL[2:0] = 001 INFRQSEL[2:0] = 010 INFRQSEL[2:0] = 011 INFRQSEL[2:0] = 100 INFRQSEL[2:0] = 101 INFRQSEL[2:0] = 110	f_{CLKIN}	66/64 FEC Scaling Minimum input frequency is in the 155 MHz range, FXDDELAY = 1	N/A N/A N/A 150.79 301.58 603.16	N/A N/A N/A — — —	N/A N/A N/A 168.22 336.44 672.88	MHz
Input Clock Frequency (CLKIN) FEC[2:0] = 111 (reverse FEC) INFRQSEL[2:0] = 001 INFRQSEL[2:0] = 010 INFRQSEL[2:0] = 011 INFRQSEL[2:0] = 100 INFRQSEL[2:0] = 101 INFRQSEL[2:0] = 110	f_{CLKIN}	64/66 FEC Scaling Minimum input frequency is in the 155 MHz range, FXDDELAY = 1	N/A N/A N/A 160.36 320.72 641.46	N/A N/A N/A — — —	N/A N/A N/A 178.90 357.80 715.59	MHz
Input Clock Rise Time (CLKIN)	t_R	Figure 2	—	—	11	ns
Input Clock Fall Time (CLKIN)	t_F	Figure 2	—	—	11	ns
Input Clock Duty Cycle	$C_{\text{DUTY_IN}}$		40	50	60	%
CLKOUT Frequency Range FRQSEL[2:0] = 001 FRQSEL[2:0] = 000 FRQSEL[2:0] = 100 FRQSEL[2:0] = 010 FRQSEL[2:0] = 101 FRQSEL[2:0] = 011 FRQSEL[2:0] = 110 FRQSEL[2:0] = 111	$f_{\text{O_19}}$ $f_{\text{O_39}}$ $f_{\text{O_78}}$ $f_{\text{O_155}}$ $f_{\text{O_311}}$ $f_{\text{O_622}}$ $f_{\text{O_1250}}$ $f_{\text{O_2500}}$		19.436 38.872 77.744 155.48 310.97 621.95 1243.9 2487.8	— — — — — — — —	21.685 43.369 86.738 173.48 346.95 693.90 1387.8 2775.6	MHz
CLKOUT Rise Time	t_R	Figure 2; differential; after 3 cm of 50 Ω FR4 stripline, FRQSEL[0:2] = 011	—	190	220	ps
CLKOUT Fall Time	t_F	Figure 2; differential; after 3 cm of 50 Ω FR4 stripline, FRQSEL[0:2] = 011	—	190	220	ps
Output Clock Duty Cycle	$C_{\text{DUTY_OUT}}$	Differential: (CLKOUT+) – (CLKOUT–), FRQSEL[0:2] = 011	48	—	52	%
RSTN/CAL Pulse Width	t_{RSTN}		20	—	—	ns
Note: The Si5321 provides a 1/32x, 1/16x, 1/8x, 1/4x, 1/2x, 1x, 2x, 4x, 8x, 16x, 32x, 64x, or 128x clock multiplication function with an option for additional frequency scaling by a factor of 255/238, 238/255, 255/237, 237/255, 66/64, or 64/66 for FEC rate conversion.						

Table 3. AC Characteristics (Continued)(V_{DD33} = 3.3 V ±5%, T_A = -20 to 85 °C)

Parameter	Symbol	Test Condition	Min	Typ	Max	Unit
Transitionless Period Required on CLKIN for Detecting a LOS Condition. INFRQSEL[2:0] = 001 INFRQSEL[2:0] = 010 INFRQSEL[2:0] = 011 INFRQSEL[2:0] = 100 INFRQSEL[2:0] = 101 INFRQSEL[2:0] = 110	t _{LOS}	Figure 3				
			24/f _{o_622}	—	32/f _{o_622}	s
			16/f _{o_622}	—	32/f _{o_622}	
			12/f _{o_622}	—	32/f _{o_622}	
			10/f _{o_622}	—	32/f _{o_622}	
			9/f _{o_622}	—	32/f _{o_622}	
			8/f _{o_622}	—	32/f _{o_622}	
Recovery Time for Clearing an LOS Condition VALTIME = 0 VALTIME = 1	t _{VAL}	Measured from when a valid reference clock is applied until the LOS flag clears	1.6 90	— —	3.2 220	ms
Note: The Si5321 provides a 1/32x, 1/16x, 1/8x, 1/4x, 1/2x, 1x, 2x, 4x, 8x, 16x, 32x, 64x, or 128x clock multiplication function with an option for additional frequency scaling by a factor of 255/238, 238/255, 255/237, 237/255, 66/64, or 64/66 for FEC rate conversion.						

Table 4. AC Characteristics (PLL Performance Characteristics) $(V_{DD33} = 3.3 \text{ V} \pm 5\%, TA = -20 \text{ to } 85 \text{ }^\circ\text{C})$

Parameter	Symbol	Test Condition	Min	Typ	Max	Unit
Wander/Jitter at 800 Hz Bandwidth (BWSEL[1:0] = 10 and BWBOOST = 0; FXDDELAY = 1)						
Jitter Tolerance (see Figure 7)	$J_{TOL(PP)}$	f = 8 Hz	1000	—	—	ns
		f = 80 Hz	100	—	—	ns
		f = 800 Hz	10	—	—	ns
CLKOUT RMS Jitter Generation FEC[2:0] = 000	$J_{GEN(RMS)}$	12 kHz to 20 MHz	—	0.9	1.2	ps
		50 kHz to 80 MHz	—	0.27	0.35	ps
CLKOUT RMS Jitter Generation FEC[2:0] = 001, 010, 100, 101, 110, 111	$J_{GEN(RMS)}$	12 kHz to 20 MHz	—	0.9	1.2	ps
		50 kHz to 80 MHz	—	0.27	0.35	ps
CLKOUT Peak-Peak Jitter Generation FEC[2:0] = 000	$J_{GEN(PP)}$	12 kHz to 20 MHz	—	7.6	11	ps
		50 kHz to 80 MHz	—	3.6	10.0	ps
CLKOUT Peak-Peak Jitter Generation FEC[2:0] = 001, 010, 100, 101, 110, 111	$J_{GEN(PP)}$	12 kHz to 20 MHz	—	6.7	9.2	ps
		50 kHz to 80 MHz	—	3.0	10.0	ps
Jitter Transfer Bandwidth (see Figure 6)	F_{BW}	BW = 800 Hz	—	800	—	Hz
Wander/Jitter Transfer Peaking	J_p	< 800 Hz	—	0.0	0.05	dB
Wander/Jitter at 1600 Hz Bandwidth (BWSEL[1:0] = 10 and BWBOOST = 1; FXDDELAY = 1)						
Jitter Tolerance (see Figure 7)		f = 16 Hz	500	—	—	ns
		f = 160 Hz	50	—	—	ns
		f = 1600 Hz	5	—	—	ns
CLKOUT RMS Jitter Generation FEC[2:0] = 000	$J_{GEN(RMS)}$	12 kHz to 20 MHz	—	.80	1.0	ps
		50 kHz to 80 MHz	—	.25	.30	ps
CLKOUT Peak-Peak Jitter Generation FEC[2:0] = 000	$J_{GEN(PP)}$	12 kHz to 20 MHz	—	6.4	10.0	ps
		50 kHz to 80 MHz	—	3.0	5.0	ps
Jitter Transfer Bandwidth (see Figure 6)	F_{BW}	BW = 1600 Hz	—	1600	—	Hz
Wander/Jitter Transfer Peaking	J_p	< 1600 Hz	—	0.0	0.05	dB
Wander/Jitter at 1600 Hz Bandwidth (BWSEL[1:0] = 01 and BWBOOST = 0; FXDDELAY = 1)						
Notes:						
1. Higher PLL bandwidth settings provide smaller clock output wander with temperature gradient.						
2. For reliable device operation, temperature gradients should be limited to 10 °C/min.						
3. Telcordia GR-1244-CORE requirements specify maximum phase transient slope during clock rearrangement in terms of nanoseconds per millisecond. The equivalent ps/μs unit is used here since the maximum phase transient magnitude for the Si5321 (tPT_MTIE) never reaches one nanosecond.						

Table 4. AC Characteristics (PLL Performance Characteristics) (Continued)(V_{DD33} = 3.3 V ±5%, TA = -20 to 85 °C)

Parameter	Symbol	Test Condition	Min	Typ	Max	Unit
Jitter Tolerance (see Figure 9)	J _{TOL(PP)}	f = 16 Hz	1000	—	—	ns
		f = 160 Hz	100	—	—	ns
		f = 1600 Hz	10	—	—	ns
CLKOUT RMS Jitter Generation FEC[2:0] = 000	J _{GEN(RMS)}	12 kHz to 20 MHz	—	0.8	1.2	ps
		50 kHz to 80 MHz	—	0.27	0.35	ps
CLKOUT RMS Jitter Generation FEC[2:0] = 001, 010, 100, 101, 110, 111	J _{GEN(RMS)}	12 kHz to 20 MHz,	—	0.9	1.2	ps
		50 kHz to 80 MHz,	—	0.27	0.35	ps
CLKOUT Peak-Peak Jitter Generation FEC[2:0] = 000	J _{GEN(PP)}	12 kHz to 20 MHz,	—	6.7	10.0	ps
		50 kHz to 80 MHz,	—	3.0	5.0	ps
CLKOUT Peak-Peak Jitter Generation FEC[2:0] = 001, 010, 100, 101, 110, 111	J _{GEN(PP)}	12 kHz to 20 MHz,	—	6.5	10.0	ps
		50 kHz to 80 MHz,	—	3.0	5.0	ps
Jitter Transfer Bandwidth (see Figure 6)	F _{BW}	BW = 1600 Hz	—	1600	—	Hz
Wander/Jitter Transfer Peaking	J _P	< 1600 Hz	—	0.0	0.1	dB
Wander/Jitter at 3200 Hz Bandwidth (BWSEL[1:0] = 01 and BWBOOST = 1; FXDDELAY = 1)						
Jitter Tolerance (see figure 7)		f = 32 Hz	500	—	—	ns
		f = 320 Hz	50	—	—	ns
		f = 3200 Hz	5	—	—	ns
CLKOUT RMS Jitter Generation FEC[2:0] = 000	J _{GEN(RMS)}	12 kHz to 20 MHz,	—	0.8	1.0	ps
		50 kHz to 80 MHz,	—	0.25	0.3	ps
CLKOUT Peak-Peak Jitter Generation FEC[2:0] = 000	J _{GEN(PP)}	12 kHz to 20 MHz,	—	6.1	10.0	ps
		50 kHz to 80 MHz,	—	3.0	5.0	ps
Jitter Transfer Bandwidth (see Figure 6)	F _{BW}	BW = 3200 Hz	—	3200	—	Hz
Wander/Jitter Transfer Peaking	J _P	< 3200 Hz	—	0.05	0.1	dB
Notes:						
1. Higher PLL bandwidth settings provide smaller clock output wander with temperature gradient.						
2. For reliable device operation, temperature gradients should be limited to 10 °C/min.						
3. Telcordia GR-1244-CORE requirements specify maximum phase transient slope during clock rearrangement in terms of nanoseconds per millisecond. The equivalent ps/μs unit is used here since the maximum phase transient magnitude for the Si5321 (tPT_MTIE) never reaches one nanosecond.						

Table 4. AC Characteristics (PLL Performance Characteristics) (Continued) $(V_{DD33} = 3.3\text{ V} \pm 5\%, TA = -20\text{ to }85\text{ }^{\circ}\text{C})$

Parameter	Symbol	Test Condition	Min	Typ	Max	Unit
Wander/Jitter at 3200 Hz Bandwidth (BWSEL[1:0] = 00 and BWBOOST = 0; FXDDELAY = 1)						
Jitter Tolerance (see Figure 7)	$J_{TOL(PP)}$	f = 32 Hz	1000	—	—	ns
		f = 320 Hz	100	—	—	ns
		f = 3200 Hz	10	—	—	ns
CLKOUT RMS Jitter Generation FEC[2:0] = 000	$J_{GEN(RMS)}$	12 kHz to 20 MHz	—	0.9	1.1	ps
		50 kHz to 80 MHz	—	0.3	0.4	ps
CLKOUT RMS Jitter Generation FEC[2:0] = 001, 010, 100, 101, 110, 111	$J_{GEN(RMS)}$	12 kHz to 20 MHz	—	0.85	1.1	ps
		50 kHz to 80 MHz	—	0.3	0.49	ps
CLKOUT Peak-Peak Jitter Generation FEC[2:0] = 000	$J_{GEN(PP)}$	12 kHz to 20 MHz	—	7.1	10.0	ps
		50 kHz to 80 MHz	—	3.2	5.0	ps
CLKOUT Peak-Peak Jitter Generation FEC[2:0] = 001, 010, 100, 101, 110, 111	$J_{GEN(PP)}$	12 kHz to 20 MHz	—	6.6	11.0	ps
		50 kHz to 80 MHz	—	3.2	5.5	ps
Jitter Transfer Bandwidth (see Figure 6)	F_{BW}	BW = 3200 Hz	—	3200	—	Hz
Wander/Jitter Transfer Peaking	J_P	< 3200 Hz	—	0.05	0.1	dB
Wander/Jitter at 6400 Hz Bandwidth (BWSEL[1:0] = 00 and BWBOOST = 1; FXDDELAY = 1)						
Jitter Tolerance (see Figure 7)		f = 64 Hz	500	—	—	ns
		f = 640 Hz	50	—	—	ns
		f = 6400 Hz	5	—	—	ns
CLKOUT RMS Jitter Generation FEC[2:0] = 000	$J_{GEN(RMS)}$	12 kHz to 20 MHz	—	0.75	0.95	ps
		50 kHz to 80 MHz	—	0.27	0.35	ps
CLKOUT Peak-Peak Jitter Generation FEC[2:0] = 000	$J_{GEN(PP)}$	12 kHz to 20 MHz	—	6.1	10.0	ps
		50 kHz to 80 MHz	—	3.1	5.0	ps
Jitter Transfer Bandwidth (see Figure 6)	F_{BW}	BW = 6400 Hz	—	6400	—	Hz
Wander/Jitter Transfer Peaking	J_P	< 6400 Hz	—	0.05	0.1	dB
Wander/Jitter at 6400 Hz Bandwidth (BWSEL[1:0] = 11 and BWBOOST = 0; FXDDELAY = 1)						
Notes:						
1. Higher PLL bandwidth settings provide smaller clock output wander with temperature gradient.						
2. For reliable device operation, temperature gradients should be limited to 10 °C/min.						
3. Telcordia GR-1244-CORE requirements specify maximum phase transient slope during clock rearrangement in terms of nanoseconds per millisecond. The equivalent ps/μs unit is used here since the maximum phase transient magnitude for the Si5321 (tPT_MTIE) never reaches one nanosecond.						

Table 4. AC Characteristics (PLL Performance Characteristics) (Continued) $(V_{DD33} = 3.3\text{ V} \pm 5\%, T_A = -20\text{ to }85\text{ }^\circ\text{C})$

Parameter	Symbol	Test Condition	Min	Typ	Max	Unit
Jitter Tolerance (see Figure 7)	$J_{TOL(PP)}$	f = 64 Hz	1000	—	—	ns
		f = 640 Hz	100	—	—	ns
		f = 6400 Hz	10	—	—	ns
CLKOUT RMS Jitter Generation FEC[2:0] = 000	$J_{GEN(RMS)}$	12 kHz to 20 MHz	—	1.0	1.3	ps
		50 kHz to 80 MHz	—	0.4	.55	ps
CLKOUT RMS Jitter Generation FEC[2:0] = 001, 010, 100,101, 110, 111	$J_{GEN(RMS)}$	12 kHz to 20 MHz	—	1.0	1.5	ps
		50 kHz to 80 MHz	—	.45	0.7	ps
CLKOUT Peak-Peak Jitter Generation FEC[2:0] = 000	$J_{GEN(PP)}$	12 kHz to 20 MHz	—	9.3	13.0	ps
		50 kHz to 80 MHz	—	4.1	6.0	ps
CLKOUT Peak-Peak Jitter Generation FEC[2:0] = 001, 010, 100,101, 110, 111	$J_{GEN(PP)}$	12 kHz to 20 MHz	—	8.0	20.0	ps
		50 kHz to 80 MHz	—	4.0	7.5	ps
Jitter Transfer Bandwidth (see Figure 6)	F_{BW}	BW = 6400 Hz	—	6400	—	Hz
Wander/Jitter Transfer Peaking	J_P	< 6400 Hz	—	0.05	0.1	dB
Wander/Jitter at 12800 Hz Bandwidth (BWSEL[1:0] = 11 and BWBOOST = 1; FXDDELAY = 1)						
Jitter Tolerance (see Figure 7)		f = 128 Hz	500	—	—	ns
		f = 1280 Hz	50	—	—	ns
		f = 12800 Hz	5	—	—	ns
CLKOUT RMS Jitter Generation FEC[2:0] = 000	$J_{GEN(RMS)}$	12 kHz to 20 MHz	—	.85	1.2	ps
		50 kHz to 80 MHz	—	.35	.55	ps
CLKOUT Peak-Peak Jitter Generation FEC[2:0] = 000	$J_{GEN(PP)}$	12 kHz to 20 MHz	—	6.8	11.0	ps
		50 kHz to 80 MHz	—	3.4	5.5	ps
Jitter Transfer Bandwidth (see Figure 6)	F_{BW}	BW = 12,800 Hz	—	12800	—	Hz
Wander/Jitter Transfer Peaking	J_P	< 12,800 Hz	—	0.05	.1	dB
Acquisition Time	T_{AQ}	RSTN/CAL high to CAL_ACTV low, with valid clock input and VALTIME = 0	—	300	350	ms
Notes:						
1. Higher PLL bandwidth settings provide smaller clock output wander with temperature gradient.						
2. For reliable device operation, temperature gradients should be limited to 10 °C/min.						
3. Telcordia GR-1244-CORE requirements specify maximum phase transient slope during clock rearrangement in terms of nanoseconds per millisecond. The equivalent ps/μs unit is used here since the maximum phase transient magnitude for the Si5321 (tPT_MTIE) never reaches one nanosecond.						

Si5321

Table 4. AC Characteristics (PLL Performance Characteristics) (Continued)

($V_{DD33} = 3.3 \text{ V} \pm 5\%$, $T_A = -20 \text{ to } 85 \text{ }^\circ\text{C}$)

Parameter	Symbol	Test Condition	Min	Typ	Max	Unit
Clock Output Wander with Temperature Gradient ^{1,2}	C_{CO_TG}	Stable Input Clock; Temperature Gradient $<10 \text{ }^\circ\text{C}/\text{min}$; 800 Hz Loop BW	—	—	45	ps/ $^\circ\text{C}/\text{min}$
Initial Frequency Accuracy in Digital Hold Mode (first 100 ms with voltage and temperature held constant)	C_{DH_FA}	Stable Input Clock Selected until entering Digital Hold	—	—	5.5	ppm
Clock Output Frequency Accuracy Over Temperature in Digital Hold Mode	C_{DH_T}	Constant Supply Voltage	—	17.2	30	ppm/ $^\circ\text{C}$
Clock Output Frequency Accuracy Over Supply Voltage in Digital Hold Mode	C_{DH_V33}	Constant Temperature	—	—	600	ppm/ V
Clock Output Phase Step ³ (See Figure 8)	t_{PT_MTIE}	When hitlessly recovering from Digital Hold mode	-200	0	200	ps
Clock Output Phase Step Slope ³ (See Figure 8)	m_{PT}	When hitlessly recovering from Digital Hold mode				
BWSEL[1:0] = 11, BWBOOST = 0		6400 Hz, No Scaling	—	—	10	ps/ μs
BWSEL[1:0] = 00, BWBOOST = 0		3200 Hz, No Scaling	—	—	5	
BWSEL[1:0] = 01, BWBOOST = 0		1600 Hz, No Scaling	—	—	2.5	
BWSEL[1:0] = 10, BWBOOST = 0		800 Hz, No Scaling	—	—	1.25	
Notes:						
1. Higher PLL bandwidth settings provide smaller clock output wander with temperature gradient.						
2. For reliable device operation, temperature gradients should be limited to $10 \text{ }^\circ\text{C}/\text{min}$.						
3. Telcordia GR-1244-CORE requirements specify maximum phase transient slope during clock rearrangement in terms of nanoseconds per millisecond. The equivalent ps/ μs unit is used here since the maximum phase transient magnitude for the Si5321 (t_{PT_MTIE}) never reaches one nanosecond.						

Table 5. Absolute Maximum Ratings

Parameter	Symbol	Value	Unit
3.3 V DC Supply Voltage	V_{DD33}	-0.5 to 3.6	V
LVTTL Input Voltage	V_{DIG}	-0.3 to ($V_{DD33} + 0.3$)	V
Maximum Current any output PIN		± 50	mA
Operating Junction Temperature	T_{JCT}	-55 to 150	$^{\circ}\text{C}$
Storage Temperature Range	T_{STG}	-55 to 150	$^{\circ}\text{C}$
ESD HBM Tolerance (100 pf, 1.5 k Ω)		1.0	kV

Note: Permanent device damage may occur if the Absolute Maximum Ratings are exceeded. Functional operation should be restricted to the conditions as specified in the operational sections of this data sheet. Exposure to absolute maximum rating conditions for extended periods may affect device reliability.

Table 6. Thermal Characteristics

Parameter	Symbol	Test Condition	Value	Unit
Thermal Resistance Junction to Ambient	ϕ_{JA}	Still Air	34.7	$^{\circ}\text{C}/\text{W}$

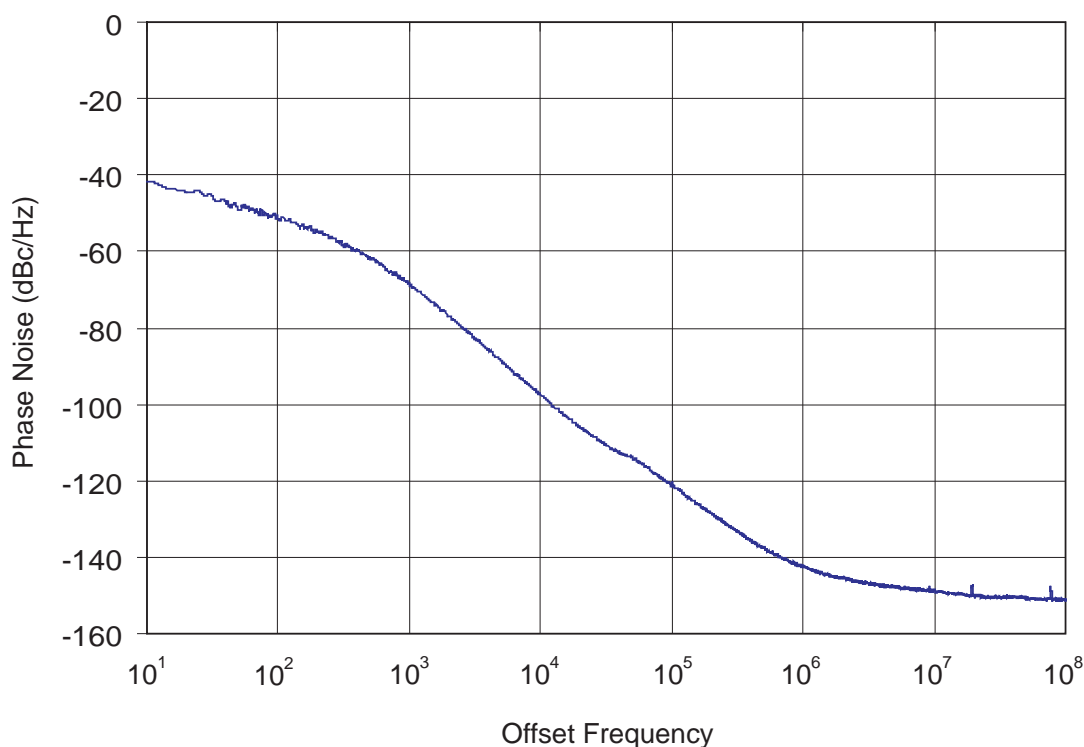

Figure 4. Typical Si5321 Phase Noise (CLKIN = 155.52 MHz, CLKOUT = 622.08 MHz, and Loop BW = 800 Hz)

Si5321

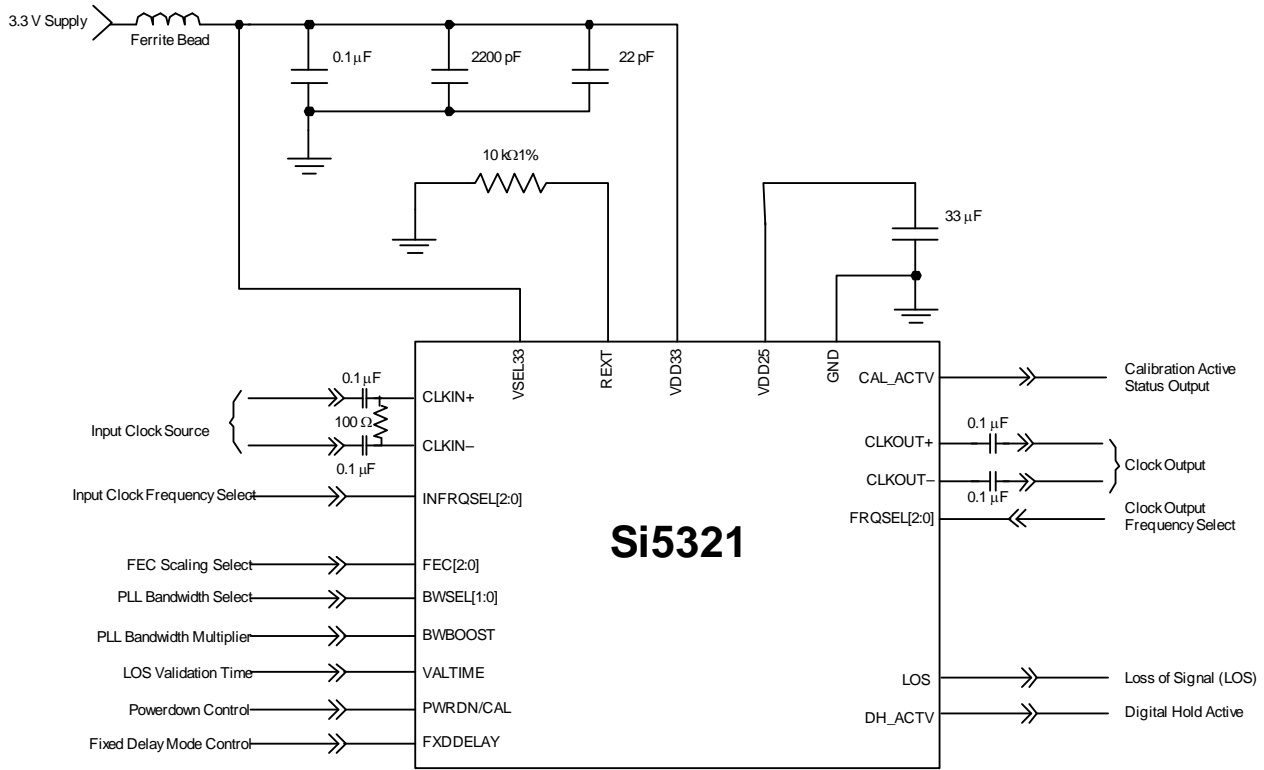

Figure 5. Si5321 Typical Application Circuit (3.3 V Supply)

2. Functional Description

The Si5321 is a high-performance precision clock multiplication and clock generation device. This device accepts a clock input in the 19, 39, 78, 155, 311, or 622 MHz range, attenuates significant amounts of jitter, and multiplies the input clock frequency to generate a clock output in the 19, 39, 78, 155, 311, 622, 1250, or 2500 MHz range. Additional forward or reverse clock rate scaling by a factor of 255/238, 255/237, or 66/64 is provided. This allows systems to easily provide clocks that are scaled for forward error correction (FEC) rates. The 255/238 and 255/237 factors support the ITU-T G.709 requirements for optical transport unit (OTU) OC-48 and OC-192 rates. The 66/64 factor allows conversion between XSBI and 10 GbE Base R rates.

Typical applications for the Si5321 in SONET/SDH systems are generation and/or cleaning of 19.44, 38.88, 77.76, 155.52, 311.04, 622.08, 1244.16, or 2488.32 MHz clocks from 19.44, 38.88, 77.76, 155.52, 311.04, or 622.08 MHz clock sources.

The Si5321 employs Skyworks Solutions DSPLL[®] technology to provide excellent jitter performance while minimizing the external component count and maximizing flexibility and ease of use. The Si5321 DSPLL phase locks to the input clock signal, attenuates jitter, and multiplies the clock frequency to generate the device's SONET/SDH-compliant clock output. The DSPLL loop bandwidth is user selectable, allowing Si5321 jitter performance optimization for different applications. The Si5321 can produce a clock output with jitter generation as low as 0.3 pSRMS (see Table 4 on page 10), making the device an ideal solution for clock multiplication in SONET/SDH (including OC-48, OC-192, and OC768), Gigabit Ethernet, and 10 GbE systems.

The Si5321 monitors the clock input signal for loss-of-signal and provides a loss-of-signal (LOS) alarm when it detects missing pulses. The Si5321 provides a digital hold capability that allows the device to continue generation of a stable output clock when the input reference is lost.

2.1. DSPLL[®]

The Si5321's phase-locked loop (PLL) uses Skyworks Solutions' DSPLL technology to eliminate jitter, noise, and the need for external loop filter components found in traditional PLL implementations. This is achieved by using a digital signal processing (DSP) algorithm to replace the loop filter commonly found in analog PLL designs. This algorithm processes the phase detector error term and generates a digital control value to adjust the frequency of the voltage-controlled oscillator (VCO).

The technology produces low phase noise clocks with less jitter than is generated using traditional methods. See Figure 4 for an example phase noise plot. In addition, because external loop filter components are not required, sensitive noise entry points are eliminated thus making the DSPLL less susceptible to board-level noise sources. This digital technology also provides highly-stable and consistent operation over all process, temperature, and voltage variations. The benefits are smaller, lower power, cleaner, reliable, and easy-to-use clock circuits.

2.1.1. Selectable Loop Filter Bandwidth

The digital characteristics of the DSPLL loop filter allow control of the loop filter parameters without the need to change external components. The Si5321 provides the user with up to eight user-selectable loop bandwidth settings for different system requirements. The base loop bandwidth is selected using the BWSEL[1:0] pins along with BWBOOST = 0 pins. When the BWBOOST is driven high, the bandwidth selected on the BWSEL[1:0] pins is doubled. (See Table 7.)

When the BWBOOST pin is asserted, the Si5321 shows improved jitter generation performance. The BWBOOST function is defined only when hitless recovery and FEC scaling are disabled. Therefore, when BWBOOST is high, the user must also drive FXDDELAY high and FEC[1:0] to 000 for proper operation.

2.2. Clock Input and Output Rate Selection

The Si5321 provides a 1/32x, 1/16x, 1/8x, 1/4x, 1/2x, 1x, 2x, 4x, 8x, 16x, 32x, 64x, or 128x clock frequency multiplication function with an option for additional frequency scaling by a factor of 255/238, 238/255, 255/237, 237/255, 66/64, or 64/66 for FEC rate compatibility. Output rates vary in accordance with the input clock rate. The multiplication factor is configured by selecting the input and output clock frequency ranges for the device.

The Si5321 accepts an input clock in the 19, 38, 77, 155, 311, or 622 MHz frequency range. The input frequency range is selected using the INFRQSEL[2:0] pins. The INFRQSEL[2:0] settings and associated output clock rates are listed in Table 8.

The Si5321's DSPLL phase locks to the clock input signal to generate an internal VCO frequency that is a multiple of the input clock frequency. The internal VCO frequency is divided down to produce a clock output in the 19, 39, 78, 155, 311, 622, 1250, or 2500 MHz frequency range. The clock output range is selected using the frequency select (FRQSEL[2:0]) pins. The FRQSEL[2:0] settings and associated output clock rates are given in Table 9.

Si5321

The Si5321 clock input frequencies are variable within the range specified in Table 3 on page 7. The output rates are scaled accordingly. If a 19.44 MHz input clock is used, the clock output frequency is 19.44, 38.88, 77.76, 155.52 MHz, etc.

Table 7. Loop Bandwidth and FEC Settings

External Inputs			Effective FEC Conversion Rate	Effective PLL Bandwidth (Hz)
BWBOOST	BWSEL [1:0]	FEC [2:0]		
0	00	000	1/1	3200
0	00	001	255/238	3200
0	00	010	238/255	3200
0	00	011	Reserved	—
0	00	100	255/237	3200
0	00	101	237/255	3200
0	00	110	66/64	3200
0	00	111	64/66	3200
0	10	000	1/1	800
0	10	001	255/238	800
0	10	010	238/255	800
0	10	011	Reserved	—
0	10	100	255/237	800
0	10	101	237/255	800
0	10	110	66/64	800
0	10	111	64/66	800
0	11	000	1/1	6400
0	11	001	255/238	6400
0	11	010	238/255	6400
0	11	011	Reserved	—
0	11	100	255/237	6400
0	11	101	237/255	6400
0	11	110	66/64	6400
0	11	111	64/66	6400
1	00	0xx	1/1	6400
1	10	0xx	1/1	1600
1	11	0xx	1/1	12800
1	01	0xx	1/1	3200
0	01	000	1/1	1600
0	01	001	255/238	1600
0	01	010	238/255	1600
0	01	011	Reserved	—
0	01	100	255/237	1600
0	01	101	237/255	1600
0	01	110	66/64	1600
0	01	111	64/66	1600

Table 8. Nominal Clock Input Frequencies

Input Clock Frequency Range	INFRQSEL2	INFRQSEL1	INFRQSEL0
Reserved	1	1	1
622 MHz	1	1	0
311 MHz	1	0	1
155 MHz	1	0	0
77 MHz	0	1	1
38 MHz	0	1	0
19 MHz	0	0	1
Reserved	0	0	0

Table 9. Nominal Clock Output Frequencies

Output Clock Frequency Range	FRQSEL2	FRQSEL1	FRQSEL0
2,488.32 MHz	1	1	1
1244.16 MHz	1	1	0
622.08 MHz	0	1	1
311.04 MHz	1	0	1
155.52 MHz	0	1	0
77.76 MHz	1	0	0
38.88 MHz	0	0	0
19.44 MHz	0	0	1

2.2.1. FEC Rate Conversion

The Si5321 provides a 1/32x, 1/16x, 1/8x, 1/4x, 1/2x, 1x, 2x, 4x, 8x, 16x, 32x, 64x, or 128x clock frequency multiplication function with an option for additional forward or reverse frequency scaling by a factor of 255/238 (15/14), 255/237 (85/79), or 66/64 (33/32) for FEC rate conversion applications. The 255/237 and the 66/64 rate conversions requires the input clock rate to be in the 155 MHz or higher ranges. The multiplication factor is configured by selecting the input and output clock frequency ranges for the device. The additional frequency scaling for FEC rate conversion is selected using the FEC[2:0] control inputs.

For example, a 622.08 MHz output clock (a non-FEC rate) can be generated from a 19.44 MHz input clock (a non-FEC rate) by setting INFRQSEL[2:0] = 001 (19.44 MHz range), setting FRQSEL[2:0] = 011 (32x multiplication) and setting FEC[2:0] = 000 (no FEC scaling). A 666.51 MHz output clock (an FEC rate) can be generated from a 19.44 MHz input clock (a non-FEC rate) by setting INFRQSEL[2:0] = 001 (19.44 MHz range), setting FRQSEL[2:0] = 011 (32x multiplication)

and setting FEC[2:0] = 001 (255/238 FEC scaling).

Finally, a 622.08 MHz output clock (a non-FEC rate) can be generated from a 20.83 MHz input clock (an FEC rate) by setting INFRQSEL[2:0] = 001 (19.44 MHz range), setting FRQSEL[2:0] = 011 (32x multiplication) and setting FEC[2:0] = 010 (238/255 FEC scaling).

2.3. PLL Performance

The Si5321 PLL provides extremely low jitter generation, high jitter tolerance, and a well-controlled jitter transfer function with low peaking and a high degree of jitter attenuation.

2.3.1. Jitter Generation

Jitter generation is defined as the amount of jitter produced at the output of the device with a jitter free input clock. Generated jitter arises from sources within the VCO and other PLL components. Jitter generation is a function of the PLL bandwidth setting. Higher loop bandwidth settings may result in lower jitter generation but may also result in less attenuation of jitter than might be present on the input clock signal.

2.3.2. Jitter Transfer

Jitter transfer is defined as the ratio of output signal jitter to input signal jitter for a specified jitter frequency. The jitter transfer characteristic determines the amount of input clock jitter that passes to the outputs. The DSPLL technology used in the Si5321 provides tightly-controlled jitter transfer curves because the PLL gain parameters are determined by digital circuits that do not vary over supply voltage, process, and temperature. In a system application, a well-controlled transfer curve minimizes the output clock jitter variation from board to board and provides more consistent system level jitter performance.

The jitter transfer characteristic is a function of the BWSEL[1:0] setting. Lower bandwidth settings result in more jitter attenuation of the incoming clock but may result in higher jitter generation. Table 4 on page 10 gives the 3 dB bandwidth and peaking values for specified BWSEL settings. Figure 6 shows the jitter transfer curve mask.

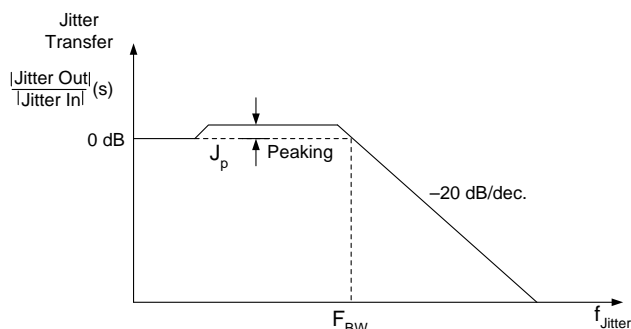

Figure 6. PLL Jitter Transfer Mask/Template

2.3.3. Jitter Tolerance

Jitter tolerance for the Si5321 is defined as the maximum peak-to-peak sinusoidal jitter that can be present on the incoming clock. The tolerance is a function of the jitter frequency because tolerance improves for lower input jitter frequency.

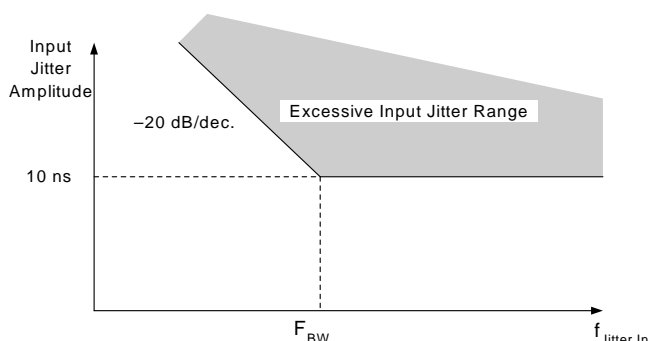

Figure 7. Jitter Tolerance Mask/Template

2.4. Loss-of-Signal Alarm

The Si5321 has loss-of-signal (LOS) circuitry that constantly monitors the CLKIN input clock for missing pulses. The LOS circuitry sets a LOS output alarm signal when missing pulses are detected.

The LOS circuitry operates as follows. Regardless of the selected input clock frequency range, the LOS circuitry divides down the input clock into the 19 MHz range. The LOS circuitry then over-samples this divided down input clock to search for extended periods of time without input clock transitions. If the LOS circuitry detects four consecutive samples of the divided down input clock that are the same state (i.e., 1111 or 0000), a LOS condition is declared; the Si5321 goes into digital hold mode, and the LOS output alarm signal is set high. The LOS sampling circuitry runs at a frequency of f_{O_78} , where f_{O_78} is the output clock frequency when the FRQSEL[2:0] pins are set to 100. Figure 3 on page 5 and Table 3 on page 7 list the minimum and maximum transitionless time periods required for declaring a LOS on the input clock (t_{LOS}).

Once the LOS alarm is asserted, it is held high until the input clock is validated over a time period designated by the VALTIME pin. When VALTIME is low, the validation time period is about 1 ms. When VALTIME is high, the validation time period is about 100 ms. If another LOS condition is detected on the input clock during the validation time (i.e., if another set of 1111 or 0000 samples are detected), the LOS alarm remains asserted and the validation time starts over. When the LOS alarm is finally released, the Si5321 exits digital hold mode and locks to the input clock. The LOS alarm is

automatically set high at power-on and at every low-to-high transition of the RSTN/CAL pin. In these cases, the Si5321 undergoes a self-calibration before releasing the LOS alarm and locking to the input clock.

The Si5321 also provides an output indicating the digital hold status of the device, DH_ACTV. The Si5321 only enters the digital hold mode upon the loss of the input clock. When this occurs, the LOS alarm will also be active. Therefore, applications that require monitoring of the status of the Si5321 need only monitor the CAL_ACTV and either the LOS or DH_ACTV outputs to know the state of the device.

2.5. Digital Hold of the PLL

When no valid input clock is available, the Si5321 digitally holds the internal oscillator to its last frequency value. This provides a stable clock to the system until an input clock is valid again. This clock maintains stable operation in the presence of constant voltage and temperature. The frequency accuracy specifications for digital hold mode are given in Table 4 on page 10.

2.6. Hitless Recovery from Digital Hold

When the Si5321 device is locked to a valid input clock, a loss of the input clock switches the device to digital hold mode. When the input clock signal returns, the device performs a hitless transition from digital hold mode back to the selected input clock. That is, the device executes “phase build-out” to absorb the phase difference between the internal VCO clock operating in digital hold mode and the new/returned input clock. The maximum phase step seen at the clock output during this transition, and the maximum slope of this step, is specified in Table 4 on page 10.

Asserting the Fixed Delay (FXDDELAY) pin disables this feature and the output clock phase and frequency locks with a known phase relationship to the input clock. Consequently, abrupt phase change on the input clock propagates through the device and the output slews at the loop bandwidth until the phase relationship is restored.

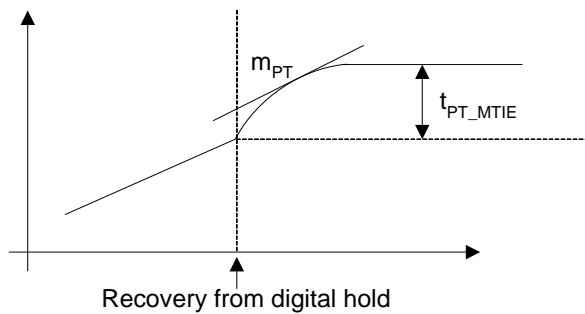

Figure 8. Recovery from Digital Hold

2.7. Reset

The Si5321 provides a Reset/Calibration pin (RSTN/CAL) that resets the device and disables all of the device outputs. When the RSTN/CAL pin is driven low, the internal circuitry enters reset mode and all LVTTTL outputs are forced into a high-impedance state. Also, the CLKOUT+ and CLKOUT– pins are connected to V_{DD25} through $100\ \Omega$ on-chip resistors. This feature is useful for applications that employ redundant clock sources and for in-circuit test applications. A low-to-high transition on RSTN/CAL initializes all digital logic to a known condition and initiates self-calibration of the DSPLL. At the completion of self-calibration, the DSPLL begins to lock to the clock input signal.

2.8. PLL Self-Calibration

The Si5321 achieves optimal jitter performance by using self-calibration circuitry to set the VCO center frequency and loop gain parameters within the DSPLL. Internal circuitry generates self calibration automatically on powerup or after a loss-of-power condition. Self-calibration also can be manually initiated by a low-to-high transition on the RSTN/CAL input.

A self-calibration should be initiated after changing the state of the FEC[2:0] inputs. Whether manually initiated or automatically initiated at powerup, the self-calibration process requires the presence of a valid input clock.

If the self-calibration is initiated without a valid input clock, the device waits for a valid input clock before executing the self-calibration. The Si5321 does not provide an output clock while waiting for a valid input clock or while executing its self-calibration. When the input clock is validated, the calibration procedure executes to completion; the device locks to the input clock, and the output clock turns on.

Subsequent losses of the input clock do not require self-calibration. If the input clock is lost following self-calibration, the device enters digital hold mode with the output clock frequency held to its last value before the LOS condition was detected. When the input clock returns and is validated, the device exits digital hold mode by re-locking to the input clock without executing another self-calibration.

2.9. Bias Generation Circuitry

The Si5321 makes use of an external resistor to set internal bias currents. The external resistor allows precise generation of bias currents, which significantly reduces power consumption and variation as compared with traditional implementations that use an internal resistor. The bias generation circuitry requires a $10\ \text{k}\Omega$ (1%) resistor connected between REXT and GND.

2.10. Differential Input Circuitry

The Si5321 provides a differential input for the clock input, CLKIN. This input is internally-biased to a voltage of V_{ICM} (see Table 2 on page 6) and may be driven by a differential or single-ended driver circuit. For transmission line termination, the termination resistor is connected externally as shown.

2.11. Differential Output Circuitry

The Si5321 utilizes a current mode logic (CML) architecture to drive the differential clock output, CLKOUT.

For single-ended output operation simply connect to either CLKOUT+ or CLKOUT- and leave the unused signal unconnected.

2.12. Power Supply Connections

The Si5321 incorporates an on-chip voltage regulator to power the device from a 3.3 V supply. The voltage regulator requires an external compensation circuit of one resistor and one capacitor to ensure stability over all operating conditions.

Internally, the Si5321 V_{DD33} pins are connected to the on-chip voltage regulator input and to the device's LVTTTL I/O circuitry. The V_{DD25} pins supply power to the core DSPLL circuitry, and are also used for connection of the external compensation circuit.

The regulator's compensation circuit is a resistor and a capacitor in series between the V_{DD25} node and ground. Typically, the resistor is incorporated into the capacitor's equivalent series resistance (ESR). The target RC time constant for this combination is 15 to 50 μ s. The capacitor used in the Si5321 evaluation board is a 33 μ f tantalum capacitor with an ESR of 0.8 Ω . This gives an RC time constant of 26.4 μ s. The Venkel part number TA6R3TCR336KBR is an example of a capacitor that meets these specifications. (See Figure 5.)

To get optimal performance from the Si5321 device, the power supply noise spectrum must comply with the plot in Figure 9. This plot shows the power supply noise tolerance mask for the Si5321. The customer should provide a 3.3 V supply that does not have noise density in excess of the amount shown in the diagram. However, the diagram cannot be used as spur criteria for a power supply that contains single tone noise.

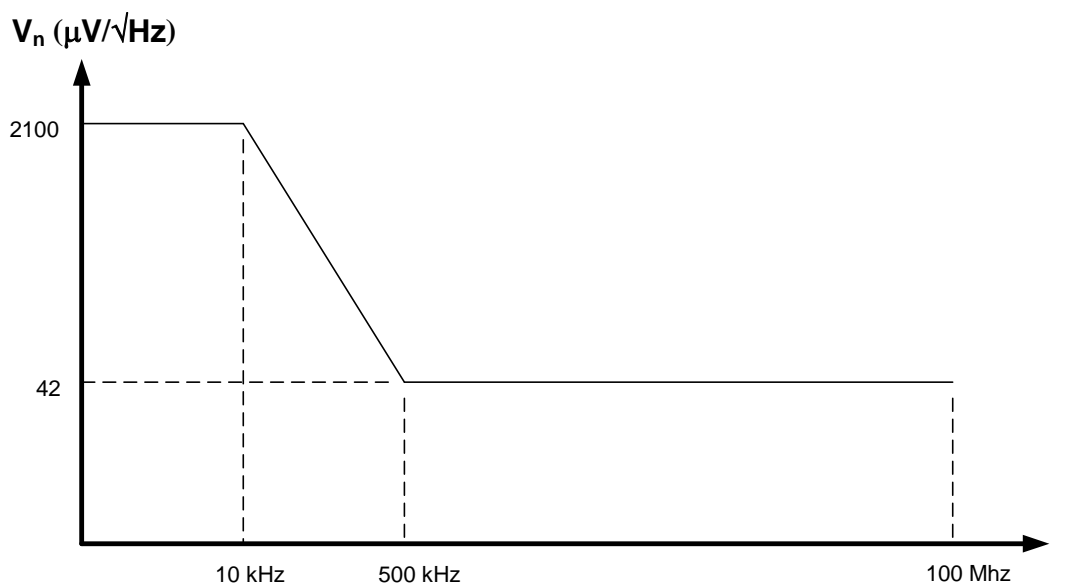

Figure 9. Power Supply Noise Tolerance Mask

2.13. Design and Layout Guidelines

Precision clock circuits are susceptible to board noise and EMI. To take precautions against unacceptable levels of board noise and EMI affecting performance of the Si5321, consider the following:

- Power the device from 3.3 V since the internal regulator provides >40 dB of isolation to the V_{DD25} pins (which power the PLL circuitry).
- When powering the device from 3.3 V, use an isolated, local plane to connect the V_{DD25} pins. Avoid running signal traces over or below this plane without a ground plane in between.
- Route all I/O traces between ground planes as much as possible
- Maintain an input clock amplitude in the 200 mV_{PP} to 500 mV_{PP} differential range.
- Excessive high-frequency harmonics of the input clock should be minimized. The use of filters on the input clock signal can be used to remove high-frequency harmonics.

3. Pin Descriptions: Si5321

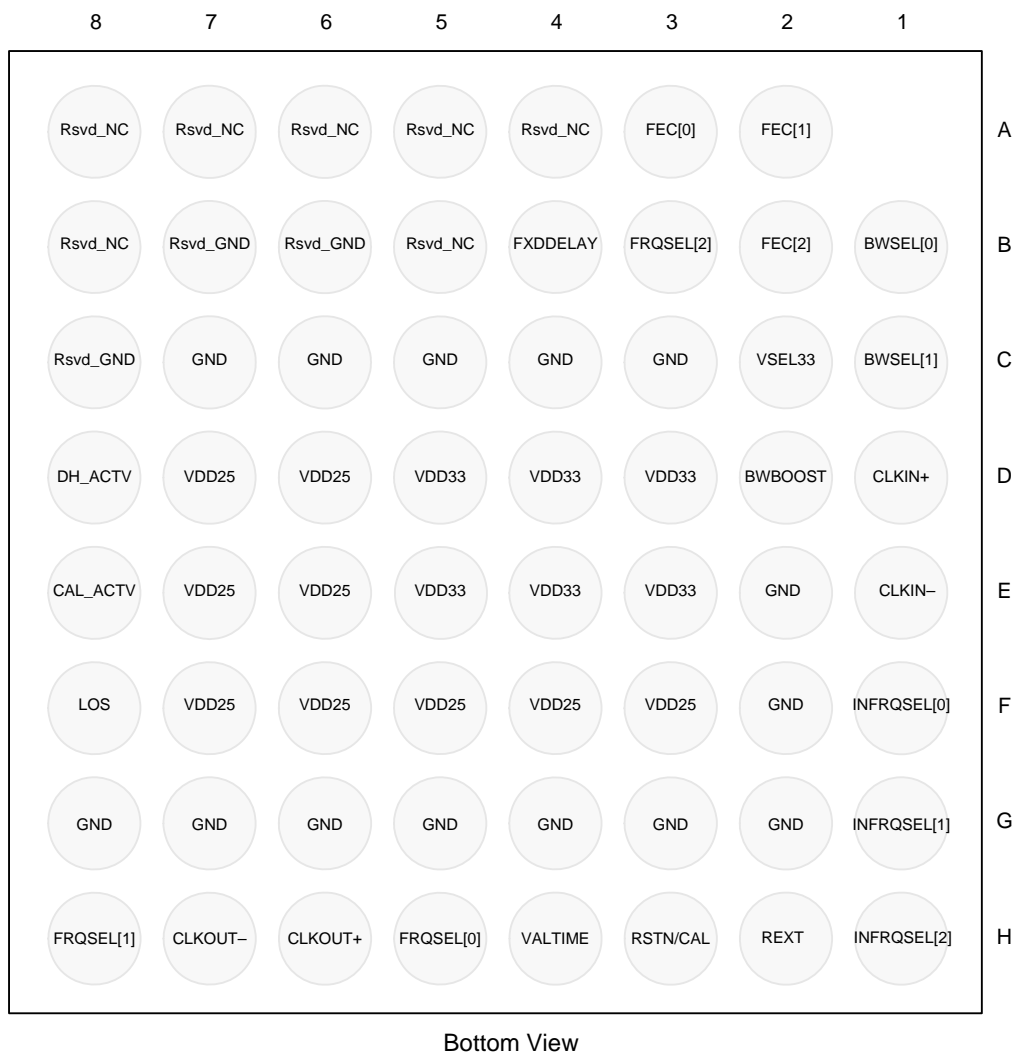
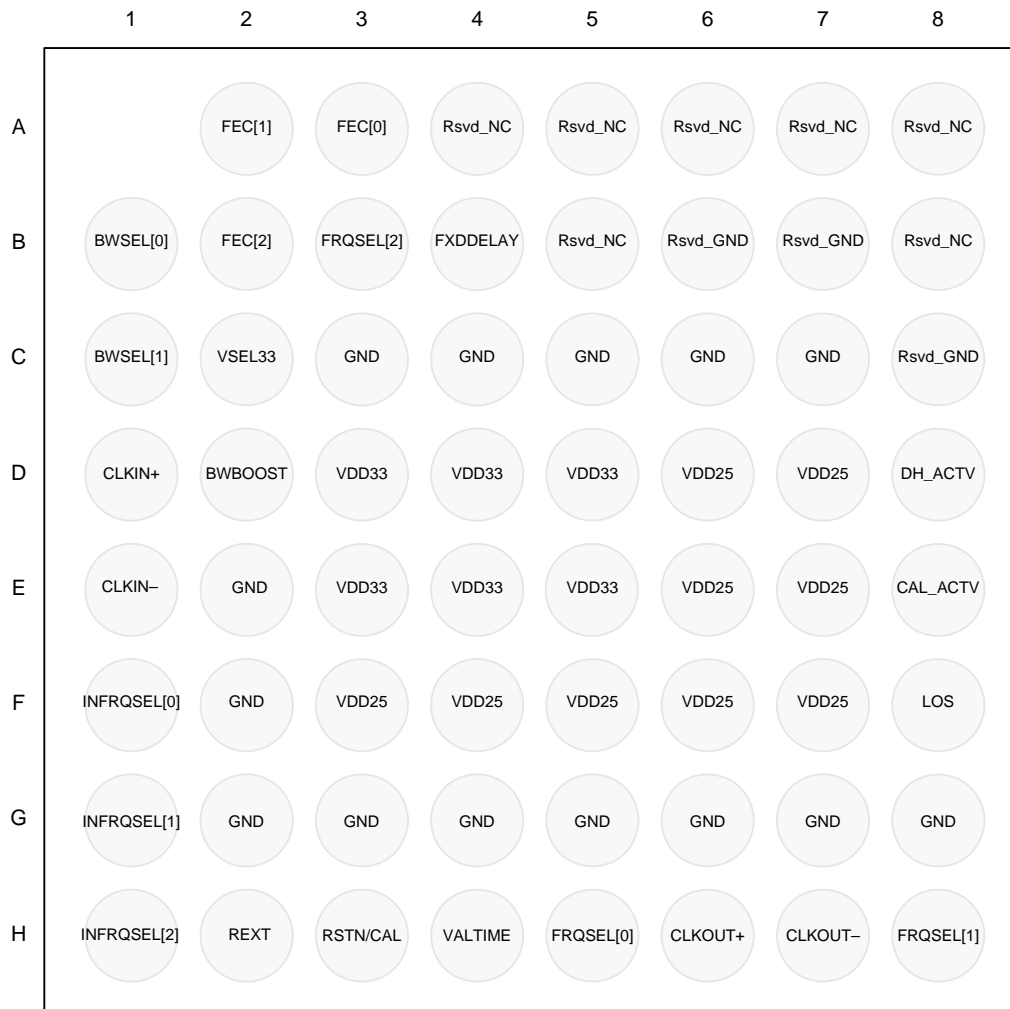

Figure 10. Si5321 Pin Configuration (Bottom View)



Top View

Figure 11. Si5321 Pin Configuration (Transparent Top View)

Table 10. Si5321 Pin Descriptions

Pin #	Pin Name	I/O	Signal Level	Description
D1 E1	CLKIN+ CLKIN–	I	AC Coupled 200–500 mV _{PPD} (See Table 2)	System Clock Input. Clock input to the DSPLL circuitry. The frequency of the CLKIN signal is multiplied by the DSPLL to generate the CLKOUT clock output. The input-to-output frequency multiplication factor is set by selecting the clock input range and the clock output range. The frequency of the CLKIN clock input can be in the 19, 38, 77, 155, 311, or 622 MHz range (nominally 19.44, 38.88, 77.76, 155.52, 311.04, or 622.08 MHz) as indicated in Table 3 on page 7. The clock input frequency is selected using the INFRQSEL[2:0] pins. The clock output frequency is selected using the FRQSEL[1:0] pins. An additional scaling factor may be selected for FEC operation using the FEC[2:0] control pins.
F1 G1 H1	INFRQSEL[0] INFRQSEL[1] INFRQSEL[2]	I*	LVTTL*	Input Frequency Range Select. Pins(INFRQSEL[2:0]) select the frequency range for the input clock, CLKIN. (See Table 3 on page 7.) 000 = Reserved. 001 = 19 MHz range. 010 = 38 MHz range. 011 = 77 MHz range. 100 = 155 MHz range. 101 = 311 MHz range. 110 = 622 MHz range. 111 = Reserved.
H6 H7	CLKOUT+ CLKOUT–	O	CML	Differential Clock Output. High-frequency clock output. The frequency of the CLKOUT output is a multiple of the frequency of the CLKIN input. The input-to-output frequency multiplication factor is set by selecting the clock input range and the clock output range. The frequency of the CLKOUT clock output can be in the 19, 38, 77, 155, 311, 622, 1244 or 2488 MHz range as indicated in Table 3 on page 7. The clock output frequency is selected using the FRQSEL[2:0] pins. The clock input frequency is selected using the INFRQSEL[2:0] pins. An additional scaling factor may be selected for FEC operation using the FEC[2:0] control pins.
*Note: The LVTTL inputs on the Si5321 device have an internal pulldown mechanism that causes the input to default to a logic low state if the input is not driven from an external source.				

Table 10. Si5321 Pin Descriptions (Continued)

Pin #	Pin Name	I/O	Signal Level	Description
H5 H8 B3	FRQSEL[0] FRQSEL[1] FRQSEL[2]	I*	LVTTL*	<p>Clock Output Frequency Range Select.</p> <p>Select the frequency range of the clock output, CLK-OUT. (See Table 3 on page 7.)</p> <p>001 = 19 MHz Frequency Range. 000 = 39 MHz Frequency Range. 100 = 78 MHz Frequency Range. 010 = 155 MHz Frequency Range. 101 = 311 MHz Frequency Range. 011 = 622 MHz Frequency Range. 110 = 1.25 GHz Frequency Range. 111 = 2.5 GHz Frequency Range.</p>
A3 A2 B2	FEC[0] FEC[1] FEC[2]	I*	LVTTL*	<p>FEC Selection.</p> <p>Enables or disables scaling of the input-to-output frequency multiplication factor for FEC clock rate compatibility.</p> <p>The frequency of the CLKOUT output is a multiple of the frequency of the CLKIN input. Selecting the clock input range, the clock output range, and the FEC scaling factor sets the input-to-output frequency multiplication factor. The clock output frequency is selected using the FRQSEL[2:0] pins. The clock input frequency is selected using the INFRQSEL[2:0] pins. Scaling factors of 255/238, 238/255, 255/237, 237/255, 66/64, or 64/66 may be selected for FEC operation using the FEC[2:0] control pins as indicated below. Scaling factors of 255/237, 237/255, 66/64, or 64/66 require that the input clock rate be in the 155 MHz or higher range.</p> <p>000 = No FEC scaling. 001 = 255/238 FEC scaling. 010 = 238/255 FEC scaling. 011 = Reserved. 100 = 255/237 FEC scaling (155 MHz or higher input clock range required). 101 = 237/255 FEC scaling (155 MHz or higher input clock range required). 110 = 66/64 FEC scaling (155 MHz or higher input clock range required). 111 = 64/66 FEC scaling (155 MHz or higher input clock range required).</p>
<p>*Note: The LVTTL inputs on the Si5321 device have an internal pulldown mechanism that causes the input to default to a logic low state if the input is not driven from an external source.</p>				

Table 10. Si5321 Pin Descriptions (Continued)

Pin #	Pin Name	I/O	Signal Level	Description
B1 C1	BWSEL[0] BWSEL[1]	I*	LVTTL*	<p>Bandwidth Select.</p> <p>BWSEL[1:0] pins set the bandwidth of the loop filter within the DSPLL to 6400, 3200, 1600, or 800 Hz as indicated below.</p> <p>00 = 3200 Hz 01 = 1600 Hz 10 = 800 Hz 11 = 6400 Hz</p> <p>Note: The loop filter bandwidth is twice the value indicated here when BWBOOST is set high.</p>
D2	BWBOOST	I*	LVTTL*	<p>Bandwidth Boost.</p> <p>Active high input to boost the selected bandwidth 2x. When this pin is high the loop filter bandwidth selected on BWSEL[1:0] is doubled. When this pin is high, FXDDELAY must also be high and FEC[2:0] must be 000.</p>
B4	FXDDELAY	I*	LVTTL*	<p>Fixed Delay Mode.</p> <p>Set high to disable hitless recovery from digital hold mode. This configuration is useful in applications that require a known or constant input-to-output phase relationship.</p> <p>When this pin is high, hitless switching from digital hold mode back to a valid clock input is disabled. When switching from digital hold mode to a valid clock input with FXDDELAY high, the clock output changes as necessary to re-establish the initial/default input-to-output phase relationship that is established after powerup or reset. The rate of change is determined by the setting of BWSEL[1:0].</p> <p>When this pin is low, hitless switching from Digital Hold mode back to a valid clock input is enabled. When switching from digital hold mode to a valid clock input with FXDDELAY low, the device enables “phase build out” to absorb the phase difference between the clock output and the clock input so that the phase change at the clock output is minimized. In this case, the input-to-output phase relationship following the transition out of digital hold mode is determined by the phase relationship at the time that switching occurs.</p> <p>Note: FXDDELAY should remain at a static high or static low level during normal operation. Transitions on this pin are allowed only when the RSTN/CAL pin is low. FXDDELAY must be set high when BWBOOST is set high.</p>
<p>*Note: The LVTTL inputs on the Si5321 device have an internal pulldown mechanism that causes the input to default to a logic low state if the input is not driven from an external source.</p>				

Table 10. Si5321 Pin Descriptions (Continued)

Pin #	Pin Name	I/O	Signal Level	Description
H4	VALTIME	I*	LVTTL*	Clock Validation Time for LOS. VALTIME sets the clock validation times for recovery from an LOS alarm condition. When VALTIME is high, the validation time is approximately 100 ms. When VALTIME is low, the validation time is approximately 2 ms.
H3	RSTN/CAL	I*	LVTTL*	Reset/Calibrate. When low, all LVTTL outputs are forced into a high impedance state, the DSPLL is forced out-of-lock, and the device control logic is reset. A low-to-high transition on RSTN/CAL initializes all digital logic to a known condition and initiates self-calibration of the DSPLL. At the completion of self-calibration, the DSPLL begins to lock to the selected clock input signal and begins to drive out the output clock signal onto the CLKOUT pins.
F8	LOS	O	LVTTL	Loss-of-Signal (LOS) Alarm for CLKIN. Active high output indicates that the Si5321 has detected missing pulses on the input clock signal. The LOS alarm is cleared after either 100 ms or 13 s of a valid CLKIN clock input, depending on the setting of the VALTIME input.
D8	DH_ACTV	O	LVTTL	Digital Hold Mode Active. Active high output indicates that the DSPLL is in digital hold mode. Digital hold mode locks the current state of the DSPLL and forces the DSPLL to continue generation of the output clock with no additional phase or frequency information from the input clock.
E8	CAL_ACTV	O	LVTTL	Calibration Mode Active. This output is driven high during the DSPLL self-calibration and the subsequent initial lock acquisition period.
C2	VSEL33	I*	LVTTL*	Reserved. This pin must be tied to VDD33 directly for normal operation.
D3–D5, E3–E5	V _{DD33}	V _{DD}	Supply	3.3 V Supply. 3.3 V power is applied to the V _{DD33} pins. Typical supply bypassing/decoupling for this configuration is indicated in the typical application diagram for 3.3 V supply operation.
*Note: The LVTTL inputs on the Si5321 device have an internal pulldown mechanism that causes the input to default to a logic low state if the input is not driven from an external source.				

Table 10. Si5321 Pin Descriptions (Continued)

Pin #	Pin Name	I/O	Signal Level	Description
D6, D7, E6, E7, F3–F7	V _{DD25}	V _{DD}	Supply	2.5 V Compensation Network. These pins provide a means of connecting the compensation network for the on-chip regulator.
C3–C7, E2, F2, G2–G8	GND	GND	Supply	Ground. Must be connected to system ground. Minimize the ground path impedance for optimal performance of the device.
H2	REXT	I	Analog	External Biasing Resistor. Used by on-chip circuitry to establish bias currents within the device. This pin must be connected to GND through a 10 k Ω (1%) resistor.
A4–8, B5, B8	RSVD_NC		LVTTL	Reserved—No Connect. This pin must be left unconnected for normal operation.
B6, B7, C8	RSVD_GND		LVTTL	Reserved—GND. This pin must be tied to GND for normal operation.
*Note: The LVTTL inputs on the Si5321 device have an internal pulldown mechanism that causes the input to default to a logic low state if the input is not driven from an external source.				

Si5321

4. Ordering Guide

Part Number	Package	Temperature Range
Si5321-G-BC	63-Ball CBGA (Prior Revision) RoHS-5	-20 to 85 °C
Si5321-H-BL	63-Ball PBGA (Current Revision) RoHS-5	-20 to 85 °C
Si5321-H-GL	63-Ball PBGA (Current Revision) RoHS-6	-20 to 85 °C

5. Package Outline

Figure 12 illustrates the package details for the Si5321. Table 11 lists the values for the dimensions shown in the illustration.

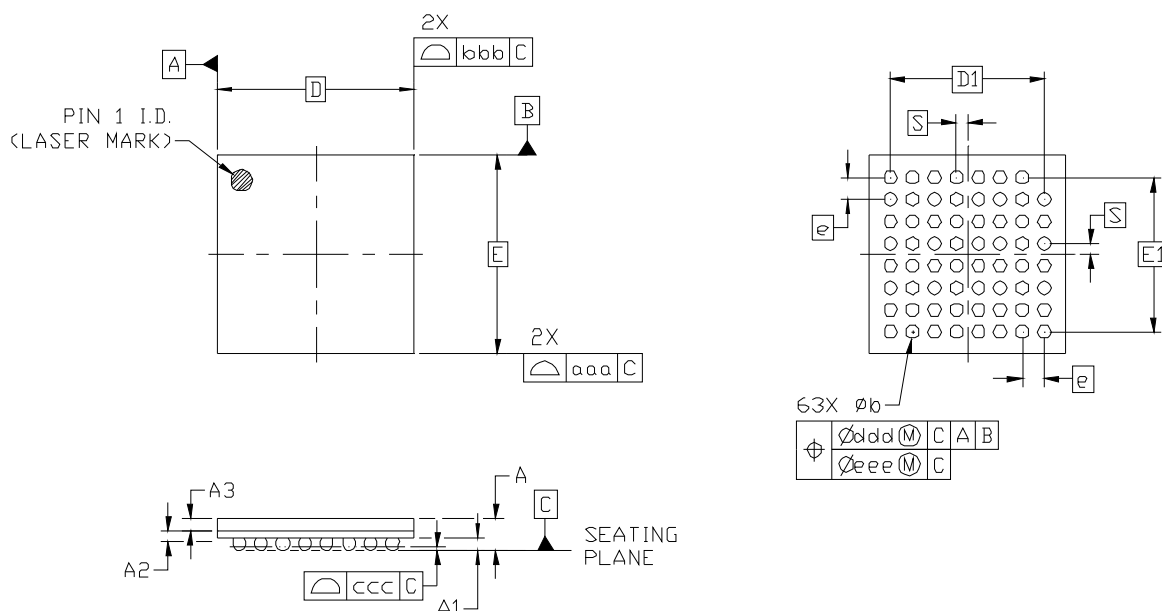

Figure 12. 63-Ball Plastic Ball Grid Array (PBGA)

Table 11. Package Diagram Dimensions (mm)

Symbol	Min	Nom	Max
A	1.24	1.41	1.58
A1	0.40	0.50	0.60
A2	0.34	0.38	0.42
A3	0.50	0.53	0.56
b	0.50	0.60	0.70
D	9.00 BSC		
E	9.00 BSC		
D1	7.00 BSC		

Symbol	Min	Nom	Max
E1	7.00 BSC		
e	1.00 BSC		
S	0.50 BSC		
aaa	0.10		
bbb	0.10		
ccc	0.12		
ddd	0.15		
eee	0.08		

Notes:

1. All dimensions shown are in millimeters (mm) unless otherwise noted.
2. Dimensioning and Tolerancing per ANSI Y14.5M-1994.
3. This drawing conforms to JEDEC outline MO-192, variation AAB-1.
4. Recommended card reflow profile is per the JEDEC/IPC J-STD-020C specification for Small Body Components.

6. 9x9 mm PBGA Card Layout

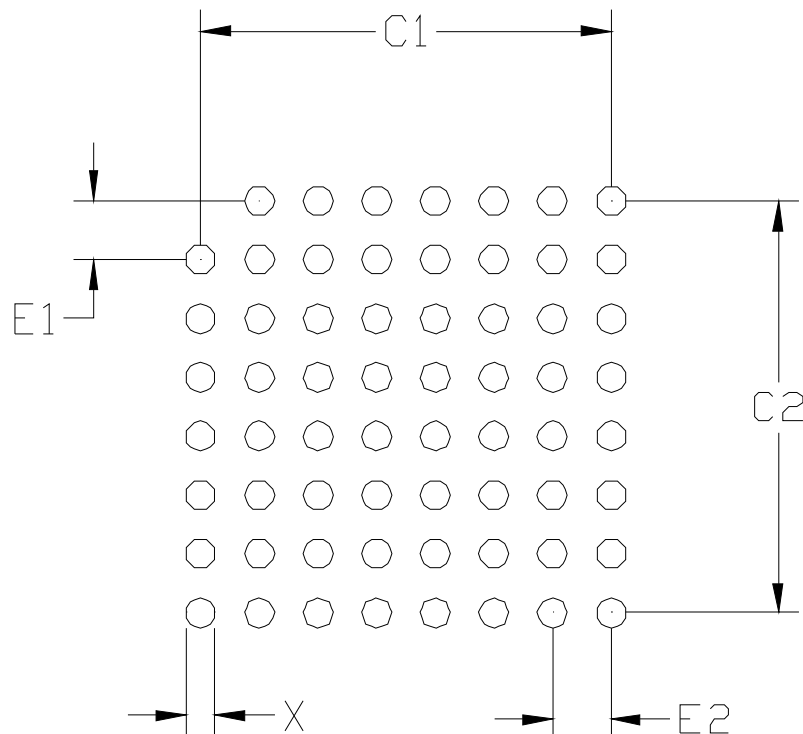

Symbol	Min	Nom	Max
X	0.40	0.45	0.50
C1	7.00		
C2	7.00		
E1	1.00		
E2	1.00		

Notes:

General

1. All dimensions shown are in millimeters (mm) unless otherwise noted.
2. Dimensioning and Tolerancing is per the ANSI Y14.5M-1994 specification.
3. This Land Pattern Design is based on the IPC-7351 guidelines.

Solder Mask Design

1. All metal pads are to be non-solder mask defined (NSMD). Clearance between the solder mask and the metal pad is to be 60 μm minimum, all the way around the pad.

Stencil Design

1. A stainless steel, laser-cut and electro-polished stencil with trapezoidal walls should be used to assure good solder paste release.
2. The stencil thickness should be 0.125 mm (5 mils).
3. The ratio of stencil aperture to land pad size should be 1:1.

Card Assembly

1. A No-Clean, Type-3 solder paste is recommended.
2. The recommended card reflow profile is per the JEDEC/IPC J-STD-020C specification for Small Body Components.

DOCUMENT CHANGE LIST

Revision 2.0 to Revision 2.1

- Updated Table 3, “AC Characteristics,” on page 7.
- Updated Figure 8, “Recovery from Digital Hold,” on page 20.
- Updated Figure 12, “63-Ball Plastic Ball Grid Array (PBGA),” on page 31.
- Updated Table 11, “Package Diagram Dimensions (mm),” on page 31.
- Added Figure 4, “Typical Si5321 Phase Noise (CLKIN = 155.52 MHz, CLKOUT = 622.08 MHz, and Loop BW = 800 Hz),” on page 15.

Revision 2.1 to Revision 2.2

- Updated Table 3, “AC Characteristics,” on page 7.
- Updated Table 11, “Package Diagram Dimensions (mm),” on page 31.

Revision 2.2 to Revision 2.3

- Updated "5. Package Outline" on page 31.

Revision 2.3 to Revision 2.4

- Device Revision G to H Transition.
- Updated test condition for differential output voltage swing, input clock frequency, clock output rise/fall time, and jitter specifications.
- Updated “3. Pin Descriptions: Si5321”.
- Updated “4. Ordering Guide” on page 30.
- Updated “5. Package Outline” on page 31.
- Updated “6. 9x9 mm PBGA Card Layout” on page 32.

Revision 2.4 to Revision 2.5

- Updated Table 6, “Thermal Characteristics,” on page 15.



ClockBuilder Pro

One-click access to Timing tools, documentation, software, source code libraries & more. Available for Windows and iOS (CBGo only).

skyworksinc.com/CBPro



Portfolio

skyworksinc.com



SW/HW

skyworksinc.com/CBPro

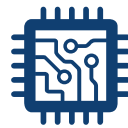

Quality

skyworksinc.com/quality



Support & Resources

skyworksinc.com/support

Copyright © 2022 Skyworks Solutions, Inc. All Rights Reserved.

Information in this document is provided in connection with Skyworks Solutions, Inc. ("Skyworks") products or services. These materials, including the information contained herein, are provided by Skyworks as a service to its customers and may be used for informational purposes only by the customer. Skyworks assumes no responsibility for errors or omissions in these materials or the information contained herein. Skyworks may change its documentation, products, services, specifications or product descriptions at any time, without notice. Skyworks makes no commitment to update the materials or information and shall have no responsibility whatsoever for conflicts, incompatibilities, or other difficulties arising from any future changes.

No license, whether express, implied, by estoppel or otherwise, is granted to any intellectual property rights by this document. Skyworks assumes no liability for any materials, products or information provided hereunder, including the sale, distribution, reproduction or use of Skyworks products, information or materials, except as may be provided in Skyworks' Terms and Conditions of Sale.

THE MATERIALS, PRODUCTS AND INFORMATION ARE PROVIDED "AS IS" WITHOUT WARRANTY OF ANY KIND, WHETHER EXPRESS, IMPLIED, STATUTORY, OR OTHERWISE, INCLUDING FITNESS FOR A PARTICULAR PURPOSE OR USE, MERCHANTABILITY, PERFORMANCE, QUALITY OR NON-INFRINGEMENT OF ANY INTELLECTUAL PROPERTY RIGHT; ALL SUCH WARRANTIES ARE HEREBY EXPRESSLY DISCLAIMED. SKYWORKS DOES NOT WARRANT THE ACCURACY OR COMPLETENESS OF THE INFORMATION, TEXT, GRAPHICS OR OTHER ITEMS CONTAINED WITHIN THESE MATERIALS. SKYWORKS SHALL NOT BE LIABLE FOR ANY DAMAGES, INCLUDING BUT NOT LIMITED TO ANY SPECIAL, INDIRECT, INCIDENTAL, STATUTORY, OR CONSEQUENTIAL DAMAGES, INCLUDING WITHOUT LIMITATION, LOST REVENUES OR LOST PROFITS THAT MAY RESULT FROM THE USE OF THE MATERIALS OR INFORMATION, WHETHER OR NOT THE RECIPIENT OF MATERIALS HAS BEEN ADVISED OF THE POSSIBILITY OF SUCH DAMAGE

Skyworks products are not intended for use in medical, lifesaving or life-sustaining applications, or other equipment in which the failure of the Skyworks products could lead to personal injury, death, physical or environmental damage. Skyworks customers using or selling Skyworks products for use in such applications do so at their own risk and agree to fully indemnify Skyworks for any damages resulting from such improper use or sale.

Customers are responsible for their products and applications using Skyworks products, which may deviate from published specifications as a result of design defects, errors, or operation of products outside of published parameters or design specifications. Customers should include design and operating safeguards to minimize these and other risks. Skyworks assumes no liability for applications assistance, customer product design, or damage to any equipment resulting from the use of Skyworks products outside of Skyworks' published specifications or parameters.

Skyworks, the Skyworks symbol, Sky5®, SkyOne®, SkyBlue™, Skyworks Green™, Clockbuilder®, DSPLL®, ISOMODem®, ProSLIC®, and SiPHY® are trademarks or registered trademarks of Skyworks Solutions, Inc. or its subsidiaries in the United States and other countries. Third-party brands and names are for identification purposes only and are the property of their respective owners. Additional information, including relevant terms and conditions, posted at www.skyworksinc.com, are incorporated by reference.

Skyworks Solutions, Inc. | Nasdaq: SWKS | sales@skyworksinc.com | www.skyworksinc.com

USA: 781-376-3000 | Asia: 886-2-2735 0399 | Europe: 33 (0)1 43548540