

REF33xx 3.9- μ A, SC70-3, SOT-23-3, and UQFN-8, 30-ppm/ $^{\circ}$ C Drift Voltage Reference

1 Features

- Microsize Packages: SC70-3, SOT-23-3, UQFN-8
- Low Supply Current: 3.9 μ A (typ)
- Extremely Low Dropout Voltage: 110 mV (typ)
- High Output Current: \pm 5 mA
- Low Temperature Drift: 30 ppm/ $^{\circ}$ C (max)
- High Initial Accuracy: \pm 0.15% (max)
- 0.1-Hz to 10-Hz Noise: 35 μ V_{PP} (REF3312)
- Voltage Options: 1.2 V, 1.8 V, 2.5 V, 3 V, 3.3 V

2 Applications

- Portable Equipment
- Tablets and Smartphones
- Hard Disk Drives
- Sensor Modules
- Data Acquisition Systems
- Medical Equipment
- Test Equipment

3 Description

The REF33xx is a low-power, precision, low-dropout voltage reference family available in tiny SC70-3 and SOT-23-3 packages, and in a 1.5-mm \times 1.5-mm UQFN-8 package. Small size and low power consumption (5- μ A max) make the REF33xx ideal for a wide variety of portable and battery-powered applications.

The REF33xx can be operated at a supply voltage 180 mV above the specified output voltage under normal load conditions, with the exception of the REF3312, which has a minimum supply voltage of 1.7 V. All models are specified for the wide temperature range of -40° C to $+125^{\circ}$ C.

Device Information⁽¹⁾

PART NUMBER	PACKAGE	BODY SIZE (NOM)
REF33xx	SOT-23 (3)	2.92 mm \times 1.30 mm
	SC70 (3)	2.00 mm \times 1.25 mm
	UQFN (8)	1.50 mm \times 1.50 mm

(1) For all available packages, see the package option addendum at the end of the datasheet.

REF3312 in a Single-Supply Signal Chain

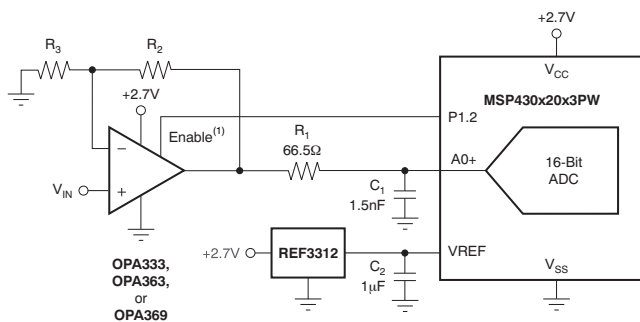

Dropout Voltage vs Load Current

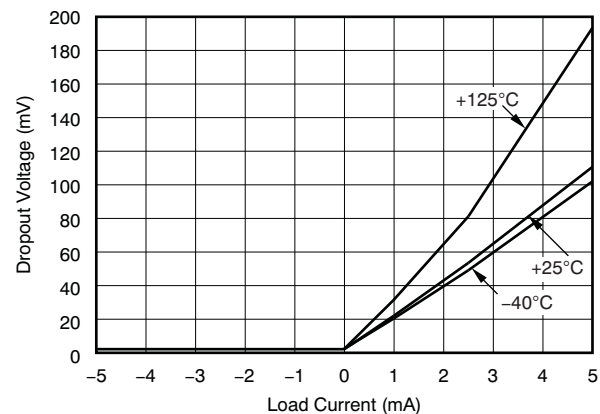

Table of Contents

1	Features	1	9.3	Feature Description.....	11
2	Applications	1	9.4	Device Functional Modes.....	12
3	Description	1	10	Applications and Implementation	13
4	Revision History	2	10.1	Application Information.....	13
5	Device Comparison	4	10.2	Typical Applications	13
6	Pin Configuration and Functions	4	11	Power-Supply Recommendations	18
7	Specifications	5	12	Layout	19
7.1	Absolute Maximum Ratings	5	12.1	Layout Guidelines	19
7.2	ESD Ratings.....	5	12.2	Layout Example	19
7.3	Recommended Operating Conditions.....	5	13	Device and Documentation Support	20
7.4	Thermal Information	5	13.1	Documentation Support	20
7.5	Electrical Characteristics.....	6	13.2	Related Links	20
7.6	Typical Characteristics	8	13.3	Receiving Notification of Documentation Updates	20
8	Parameter Measurement Information	10	13.4	Community Resources.....	20
8.1	Thermal Hysteresis	10	13.5	Trademarks	20
9	Detailed Description	11	13.6	Electrostatic Discharge Caution.....	20
9.1	Overview	11	13.7	Glossary	21
9.2	Functional Block Diagram	11	14	Mechanical, Packaging, and Orderable Information	21

4 Revision History

NOTE: Page numbers for previous revisions may differ from page numbers in the current version.

Changes from Revision F (November 2016) to Revision G	Page
• Added <i>Long-term stability</i> parameter and associated footnote to REF33xx section of <i>Electrical Characteristics</i> table	6

Changes from Revision E (October 2014) to Revision F	Page
• Changed minimum supply voltage value in second paragraph of <i>Description</i> section	1
• Changed <i>Device Information</i> table	1
• Changed <i>ESD Ratings</i> table: changed title and format, moved T_{stg} parameter to <i>Absolute Maximum Ratings</i> table	5
• Changed supply voltage value in footnote of <i>Recommended Operating Conditions</i> table	5
• Changed supply voltage value in footnote 1 of <i>Electrical Characteristics</i> table	6
• Changed minimum supply voltage value in <i>Device Functional Modes</i> section	12
• Changed minimum supply voltage value in <i>Power-Supply Recommendations</i> section	18

Changes from Revision D (June 2014) to Revision E	Page
• Added REF3325 UQFN package to data sheet	1
• Added note to <i>Applications and Implementation</i> section.....	13

Changes from Revision C (March 2014) to Revision D	Page
• Added note to Recommended Operating Conditions.....	5
• Moved <i>Thermal Hysteresis</i> section to <i>Parameter Measurement Information</i> section.....	10
• Changed <i>Applications and Implementation</i> section to latest standard; added new sections	13

Changes from Revision B (February 2014) to Revision C
Page

- Changed Recommended Operating Conditions supply input voltage range maximum value from 55 to 5.5..... **5**
-

Changes from Revision A (September 2007) to Revision B
Page

- Changed document format to meet latest data sheet standards; added new sections and moved existing sections..... **1**
 - Moved package figures from front page to *Pin Configuration and Functions* **1**
 - Added new figures to front page **1**
 - Deleted Ordering Information table; see Package Option Addendum for most current ordering information..... **4**
 - Added RSE pin configuration **4**
 - Added Thermal Information table **5**
 - Deleted Thermal Resistance parameter in Electrical Characteristics; see new Thermal Information table..... **7**
-

5 Device Comparison

PRODUCT	DESCRIPTION
REF3312	1.25 V
REF3318	1.8 V
REF3320	2.048 V
REF3325	2.5 V
REF3330	3.0 V
REF3333	3.3 V

6 Pin Configuration and Functions

REF3312, REF3318, REF3320, REF3325, REF3330, REF3333
 DBZ Package and DCK Package
 SOT-23-3, SC70-3
 (Top View)

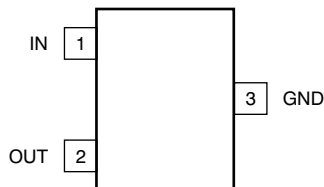

REF3312, REF3318, REF3320, REF3325, REF3330, REF3333
 RSE Package
 UQFN-8
 (Top View)

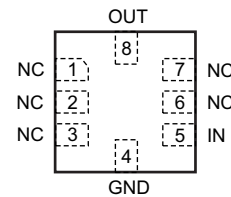

Pin Functions

NAME	PIN		DESCRIPTION
	DBZ, DCK	RSE	
GND	3	4	Ground
IN	1	5	Input supply voltage
NC	—	1, 2, 3, 6, 7	Not connected
OUT	2	8	Output voltage

7 Specifications

7.1 Absolute Maximum Ratings

over operating free-air temperature range (unless otherwise noted).⁽¹⁾

		MIN	MAX	UNIT
Voltage	Input voltage		7.5	V
	Output voltage		5	
Current	Output short-circuit, I_{SC} ⁽²⁾		180	mA
Temperature	Operating	-50	150	°C
	Junction, T_J		150	
	Storage, T_{stg}	-65	150	

- (1) Stresses beyond those listed under *Absolute Maximum Ratings* may cause permanent damage to the device. These are stress ratings only, which do not imply functional operation of the device at these or any other conditions beyond those indicated under *Recommended Operating Conditions*. Exposure to absolute-maximum-rated conditions for extended periods may affect device reliability.
- (2) See the [Power-Supply Recommendations](#) section of this data sheet.

7.2 ESD Ratings

		VALUE	UNIT
$V_{(ESD)}$ Electrostatic discharge	Human body model (HBM), per ANSI/ESDA/JEDEC JS-001 ⁽¹⁾	±4000	V
	Charged device model (CDM), per JEDEC specification JESD22-C101 ⁽²⁾	±1000	
	Machine model (MM)	±200	

- (1) JEDEC document JEP155 states that 500-V HBM allows safe manufacturing with a standard ESD control process.
- (2) JEDEC document JEP157 states that 250-V CDM allows safe manufacturing with a standard ESD control process.

7.3 Recommended Operating Conditions

over operating free-air temperature range (unless otherwise noted).

		MIN	NOM	MAX	UNIT
V_{IN}	Supply input voltage ⁽¹⁾	$V_{OUT} + 0.2$		5.5	V
I_{OUT}	Output current range	-30		30	mA

- (1) The minimum supply voltage for the REF3312 is 1.7 V.

7.4 Thermal Information

THERMAL METRIC ⁽¹⁾		REF33xx		REF3325, REF3330	UNIT
		DCK (SC70)	DBZ (SOT-23)	RSE (UQFN)	
		3 PINS	3 PINS	8 PINS	
$R_{\theta JA}$	Junction-to-ambient thermal resistance	279.7	313.1	61.2	°C/W
$R_{\theta JC(top)}$	Junction-to-case (top) thermal resistance	136.3	144.0	32.6	°C/W
$R_{\theta JB}$	Junction-to-board thermal resistance	56.9	109.3	16.0	°C/W
Ψ_{JT}	Junction-to-top characterization parameter	11.0	18.2	1.3	°C/W
Ψ_{JB}	Junction-to-board characterization parameter	56.1	107.9	16.0	°C/W
$R_{\theta JC(bot)}$	Junction-to-case (bottom) thermal resistance	N/A	N/A	N/A	°C/W

- (1) For more information about traditional and new thermal metrics, see the [Semiconductor and IC Package Thermal Metrics](#) application report.

7.5 Electrical Characteristics

 At $T_A = 25^\circ\text{C}$, $V_{IN} = 5\text{ V}$, and $I_{LOAD} = 0\text{ mA}$ (unless otherwise noted).

PARAMETER		TEST CONDITIONS	MIN	TYP	MAX	UNIT
REF3312 (1.25 V)						
V_{OUT}	Output voltage			1.25		V
	Initial accuracy		-0.15%		0.15%	
	Output voltage noise	$f = 0.1\text{ Hz to }10\text{ Hz}$		35		μV_{PP}
REF3318 (1.8 V)						
V_{OUT}	Output voltage			1.8		V
	Initial accuracy		-0.15%		0.15%	
	Output voltage noise	$f = 0.1\text{ Hz to }10\text{ Hz}$		50		μV_{PP}
REF3320 (2.048 V)						
V_{OUT}	Output voltage			2.048		V
	Initial accuracy		-0.15%		0.15%	
	Output voltage noise	$f = 0.1\text{ Hz to }10\text{ Hz}$		55		μV_{PP}
REF3325 (2.5 V)						
V_{OUT}	Output voltage			2.5		V
	Initial accuracy		-0.15%		0.15%	
	Output voltage noise	$f = 0.1\text{ Hz to }10\text{ Hz}$		70		μV_{PP}
REF3330 (3.0 V)						
V_{OUT}	Output voltage			3.0		V
	Initial accuracy		-0.15%		0.15%	
	Output voltage noise	$f = 0.1\text{ Hz to }10\text{ Hz}$		84		μV_{PP}
REF3333 (3.3 V)						
V_{OUT}	Output voltage			3.3		V
	Initial accuracy		-0.15%		0.15%	
	Output voltage noise	$f = 0.1\text{ Hz to }10\text{ Hz}$		92		μV_{PP}
REF33xx (REF3312, REF3318, REF3320, REF3325, REF3330, REF3333)						
dV_{OUT}/dT	Output voltage temperature drift	$-40^\circ\text{C to }85^\circ\text{C}$		9	30	ppm/ $^\circ\text{C}$
		$-40^\circ\text{C to }125^\circ\text{C}$		8	30	
$\Delta V_{O(\Delta V)}$	Line regulation	$V_{IN} = V_{OUT} + 200\text{ mV to }5.5\text{ V}^{(1)}$	-50	6	50	ppm/V
		$0^\circ\text{C to }+70^\circ\text{C}$		6		
		$-40^\circ\text{C to }85^\circ\text{C}$		8		
		$-40^\circ\text{C to }125^\circ\text{C}$		30		
$\Delta V_{O(\Delta I)}$	Load regulation	$V_{IN} = V_{OUT} + 200\text{ mV}^{(1)}$	-50	6	50	ppm/mA
		$I_{LOAD} = \pm 5\text{ mA}, 0^\circ\text{C to }70^\circ\text{C}$		10		
		$-40^\circ\text{C to }85^\circ\text{C}$		20		
		$-40^\circ\text{C to }125^\circ\text{C}$		20		
	Long-term stability ⁽²⁾	0h to 1000h at 25°C		55		ppm
dT	Thermal hysteresis ⁽³⁾			90		ppm
$V_{IN} - V_{OUT}$	Minimum dropout voltage ⁽¹⁾	$I_{LOAD} = \pm 5\text{ mA}$		110	160	mV
		$0^\circ\text{C to }70^\circ\text{C}$		120		
		$-40^\circ\text{C to }85^\circ\text{C}$		135		
		$-40^\circ\text{C to }125^\circ\text{C}$		180		
		$I_{LOAD} = \pm 2\text{ mA}, -40^\circ\text{C to }85^\circ\text{C}$			70	
I_{SC}	Short-circuit current	Sourcing and sinking		35		mA
	Capacitive load		0.1		10	μF
	Turn-on settling time	To 0.1% with $C_L = 1\ \mu\text{F}$		2		ms

(1) The minimum supply voltage for the REF3312 is 1.7 V.

(2) The long-term stability number reduces as the time increases.

 (3) The thermal hysteresis procedure is explained in more detail in the [Thermal Hysteresis](#) section.

Electrical Characteristics (continued)

At $T_A = 25^\circ\text{C}$, $V_{IN} = 5\text{ V}$, and $I_{LOAD} = 0\text{ mA}$ (unless otherwise noted).

PARAMETER		TEST CONDITIONS	MIN	TYP	MAX	UNIT
POWER SUPPLY						
V_S	Specified voltage range		$V_{OUT} + 0.2^{(1)}$		5.5	V
	Operating voltage range	$I_{LOAD} = 0\text{ mA}$		$V_{OUT} + 0.005$	5.5	V
I_Q	Current			3.9	5	μA
		-40°C to 85°C		4.4	6.5	
		-40°C to 125°C		4.8	8.5	
TEMPERATURE						
T_A	Specified range		-40		125	$^\circ\text{C}$
	Operating range		-50		150	

7.6 Typical Characteristics

At $T_A = 25^\circ\text{C}$ and $V_{IN} = 5\text{ V}$, and REF3325 used for typical characteristic measurements (unless otherwise noted).

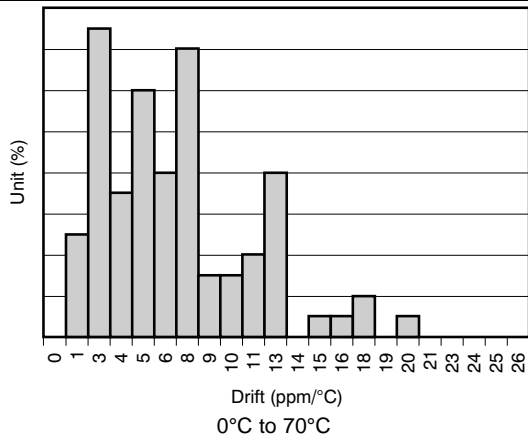

Figure 1. Temperature Drift

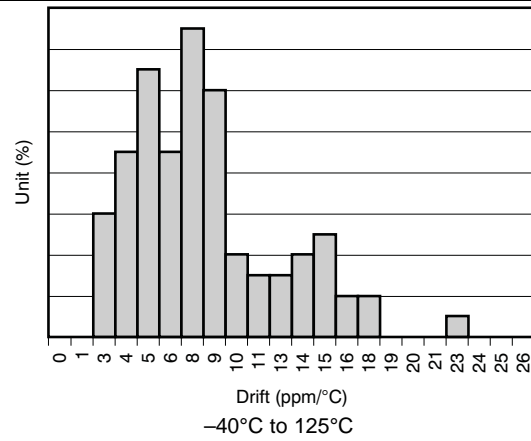

Figure 2. Temperature Drift

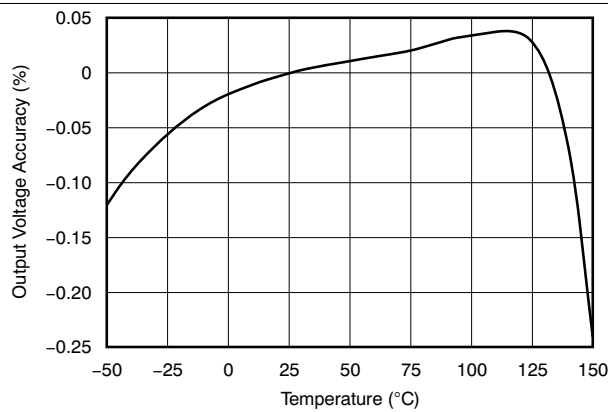

Figure 3. Output Voltage Accuracy vs Temperature

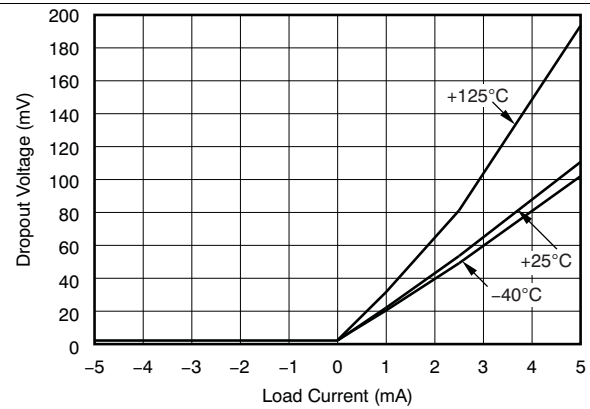

Figure 4. Dropout Voltage vs Load Current

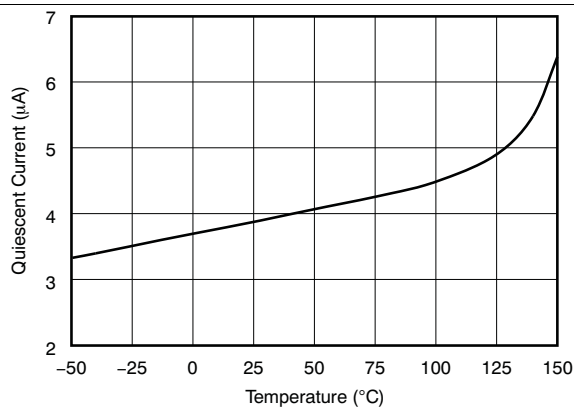

Figure 5. Quiescent Current vs Temperature

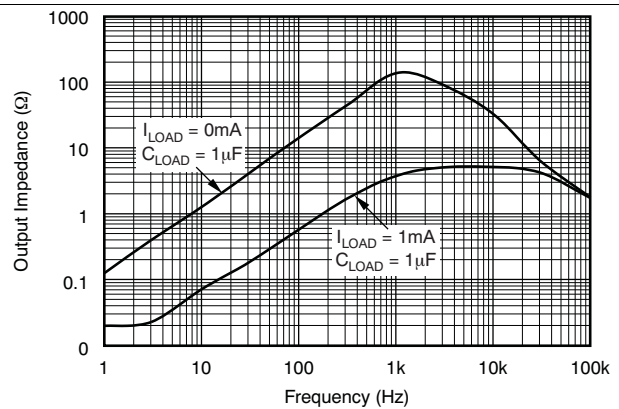

Figure 6. Output Impedance vs Frequency

Typical Characteristics (continued)

At $T_A = 25^\circ\text{C}$ and $V_{IN} = 5\text{ V}$, and REF3325 used for typical characteristic measurements (unless otherwise noted).

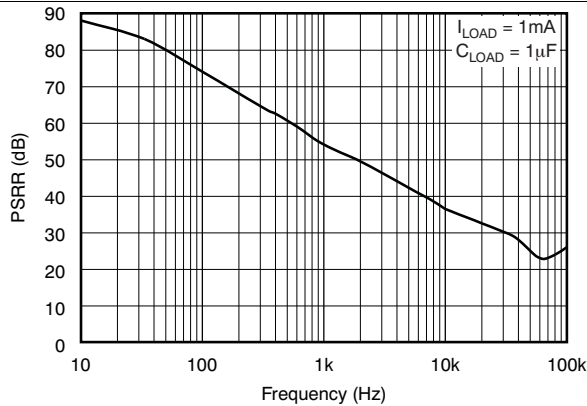

Figure 7. Power-Supply Rejection Ratio vs Frequency

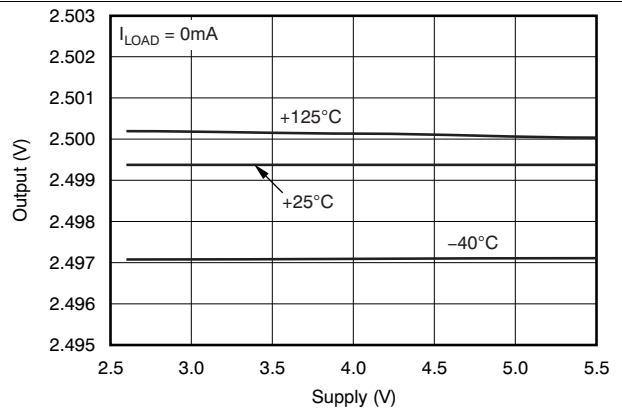

Figure 8. Output vs Supply

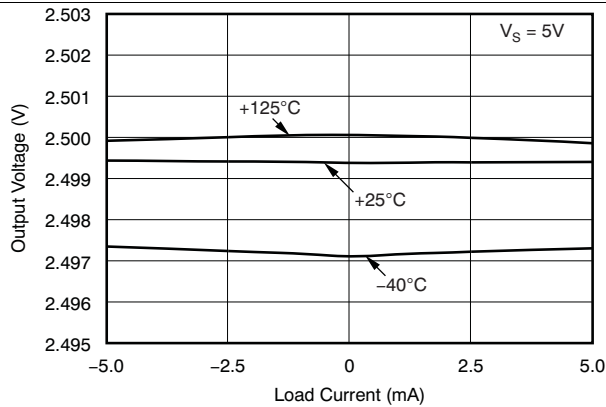

Figure 9. Output Voltage vs Load Current

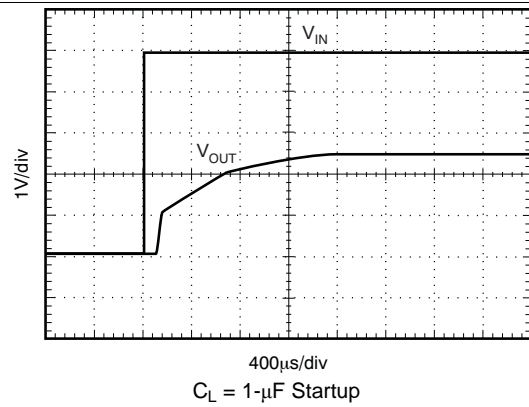

Figure 10. Step Response

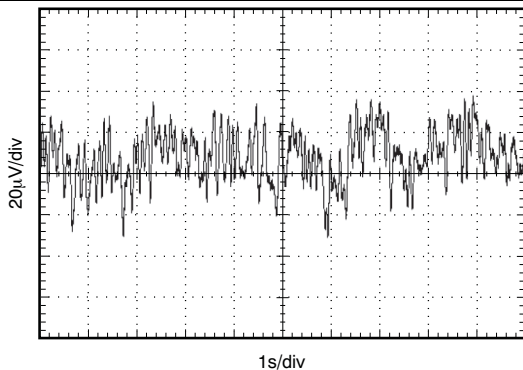

Figure 11. 0.1-Hz to 10-Hz Noise

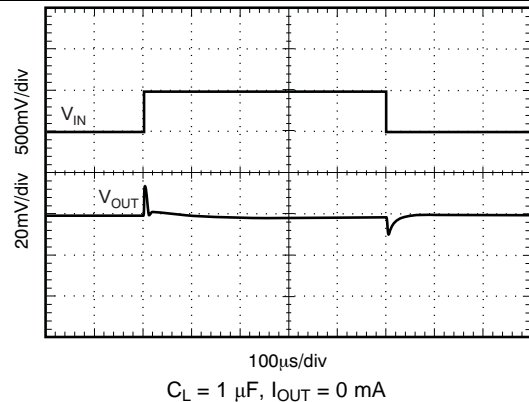
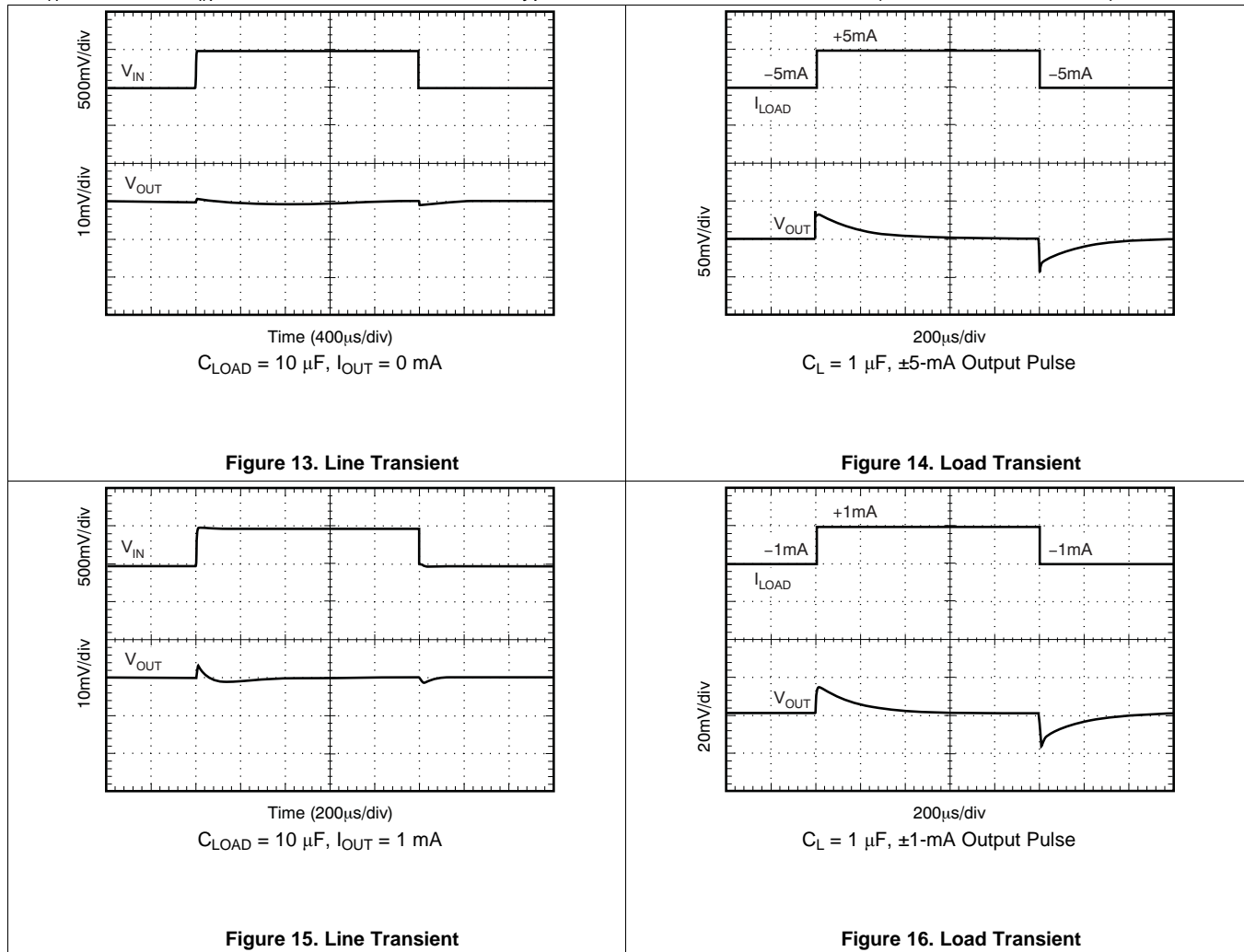

Figure 12. Line Transient

Typical Characteristics (continued)

At $T_A = 25^\circ\text{C}$ and $V_{IN} = 5\text{ V}$, and REF3325 used for typical characteristic measurements (unless otherwise noted).



8 Parameter Measurement Information

8.1 Thermal Hysteresis

Thermal hysteresis for the REF33xx is defined as the change in output voltage after operating the device at 25°C , cycling the device through the specified temperature range, and returning to 25°C . It can be expressed as [Equation 1](#):

$$V_{HYST} = \left(\frac{|V_{PRE} - V_{POST}|}{V_{NOM}} \right) \cdot 10^6 \text{ (ppm)}$$

where

- V_{HYST} = thermal hysteresis (in units of ppm).
 - V_{NOM} = the specified output voltage.
 - V_{PRE} = output voltage measured at 25°C pretemperature cycling.
 - V_{POST} = output voltage measured after the device cycles from 25°C through the specified temperature range of -40°C to 125°C and returns to 25°C .
- (1)

9 Detailed Description

9.1 Overview

The REF33xx is a family of low-power, precision band-gap voltage references that are specifically designed for extremely low dropout, excellent initial voltage accuracy with a high output current. A simplified block diagram of the REF33xx is shown in the [Functional Block Diagram](#) section. [Figure 17](#) shows the typical connections for the REF33xx. A supply bypass capacitor ranging between 1 μF to 10 μF is recommended. The total capacitive load at the output must be between 0.1 μF to 10 μF to ensure output stability.

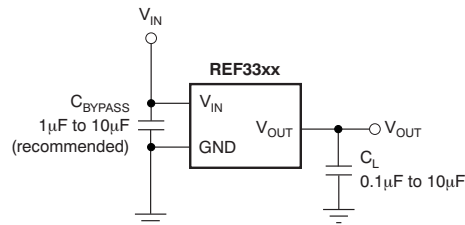
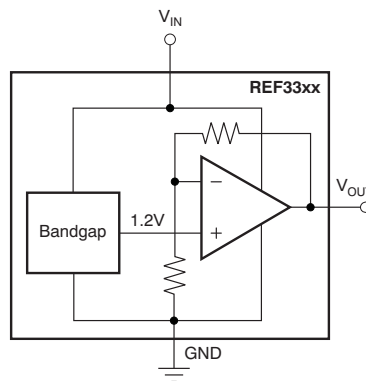

Figure 17. Basic Connections

9.2 Functional Block Diagram



9.3 Feature Description

9.3.1 Start-Up Time

The REF33xx features an advanced start-up circuit. Start-up time is almost independent of load (with a 0.1- μF to 10- μF load). Upon startup, the current boost circuit forces the output voltage. When the preset voltage is reached, the REF33xx switches to the second stage of output circuitry to precisely set the output voltage. [Figure 18](#) shows the start-up time of the REF3325 for three different capacitive loads. In all three cases, the output voltage settles within 2 ms.

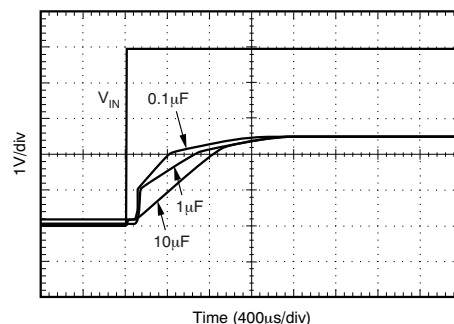

Figure 18. Start-Up Time

Feature Description (continued)

9.3.2 Low Temperature Drift

The REF33xx is designed for minimal drift error, defined as the change in output voltage over temperature. The drift is calculated using the box method, as described in [Equation 2](#):

$$\text{Drift} = \left(\frac{V_{\text{OUTMAX}} - V_{\text{OUTMIN}}}{V_{\text{OUT}} \cdot \text{Temperature Range}} \right) \cdot 10^6 \text{ (ppm)} \quad (2)$$

9.3.3 Power Dissipation

The REF33xx family is specified to deliver current loads of ± 5 mA over the specified input voltage range. The temperature of the device increases according to [Equation 3](#):

$$T_J = T_A + P_D \cdot R_{\theta JA}$$

where

- T_J = junction temperature ($^{\circ}\text{C}$).
- T_A = ambient temperature ($^{\circ}\text{C}$).
- P_D = power dissipation (W) = $V_{\text{IN}} \times I_Q + (V_{\text{IN}} - V_{\text{OUT}}) I_{\text{OUT}}$.
- $R_{\theta JA}$ = Junction-to-ambient thermal resistance ($^{\circ}\text{C}/\text{W}$). (3)

The REF33xx junction temperature must not exceed the absolute maximum rating of 150°C .

9.3.4 Noise Performance

Typical 0.1-Hz to 10-Hz voltage noise for each member of the REF33xx family is specified in the [Electrical Characteristics](#) table. The noise voltage increases with output voltage and operating temperature. Use additional filtering to improve output noise levels. Give special attention to ensure that the output impedance does not degrade output voltage accuracy.

9.4 Device Functional Modes

The REF33xx is powered on when the voltage on the IN pin is greater than $V_{\text{OUT}} + 0.2$ V, except for the REF3312, where the minimum supply voltage is 1.7 V. The maximum input voltage for the REF33xx is 5.5 V. Use a supply bypass capacitor ranging between 1 μF to 10 μF . The total capacitive load at the output must be between 0.1 μF to 10 μF to ensure output stability.

10 Applications and Implementation

NOTE

Information in the following applications and implementation sections is not part of the TI component specification, and TI does not warrant its accuracy or completeness. TI's customers are responsible for determining suitability of components for their purposes. Customers should validate and test their design implementation to confirm system functionality.

10.1 Application Information

The REF33xx is a family of low-power, precision band-gap voltage references that are specifically designed for extremely low dropout, excellent initial voltage accuracy with a high output current. The extremely small size of the SC70-3, SOT-23-3, and UQFN-8 make these references very attractive for space-constrained applications. The following section describes one common application.

10.2 Typical Applications

10.2.1 REF3312 in a Bipolar Signal-Chain Configuration

The circuit in Figure 19 consists of a low-power reference and conditioning circuit. This circuit attenuates and level-shifts a bipolar input voltage within the proper input range of a single-supply, low-power, 16-bit $\Delta\Sigma$ analog-to-digital converter (ADC), such as the one inside the MSP430 (or other similar single-supply ADCs). Precision reference circuits are used to level-shift the input signal, provide the ADC reference voltage, and create a well-regulated supply voltage for the low-power analog circuitry. A low-power, zero-drift op amp circuit is used to attenuate and level-shift the input signal.

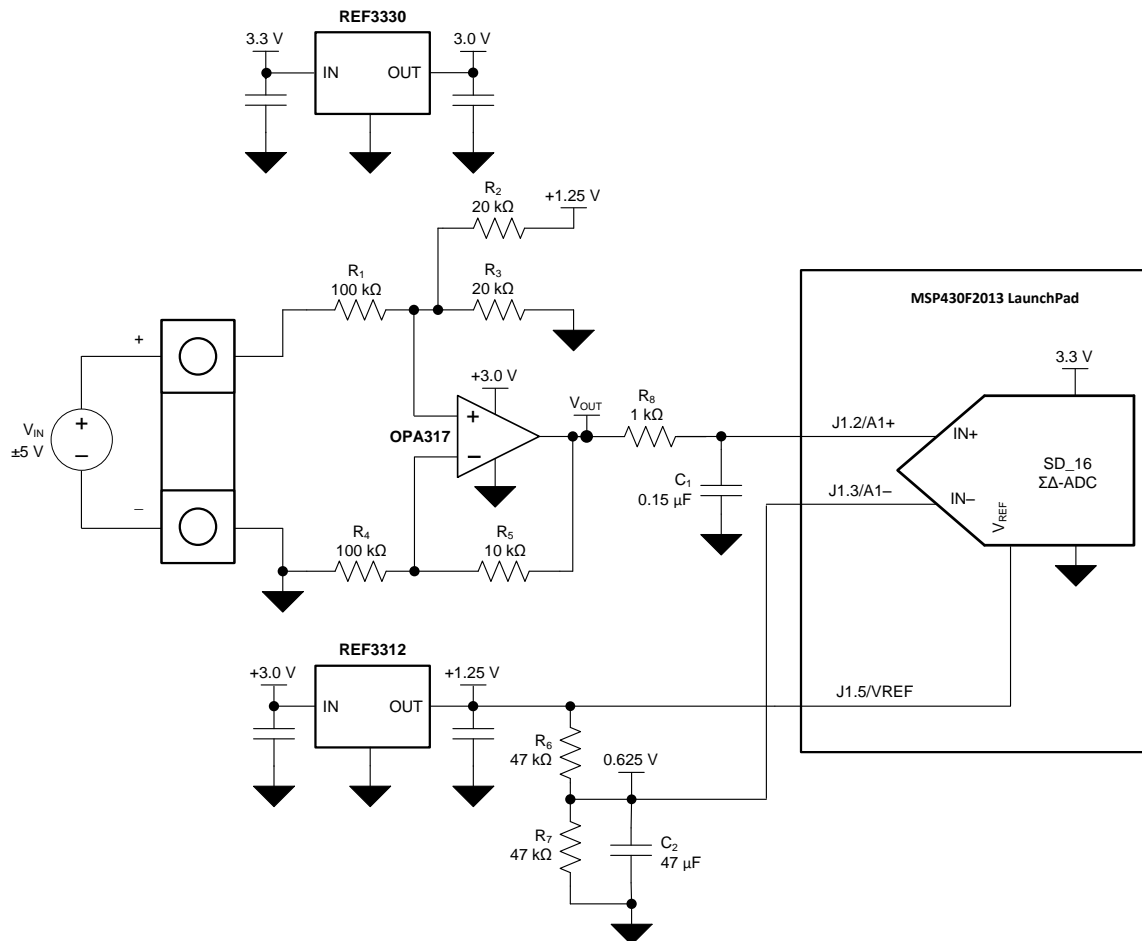

Figure 19. Bipolar Signal-Chain Configuration

Typical Applications (continued)

10.2.1.1 Design Requirements

The design requirements are as follows:

- Supply voltage: 3.3 V
- Maximum input voltage: ± 6 V
- Specified input voltage: ± 5 V
- ADC reference voltage: 1.25 V

10.2.1.2 Detailed Design Procedure

[Figure 19](#) depicts a simplified schematic for this design showing the MSP430 ADC inputs and full input conditioning circuitry. The ADC is configured for a bipolar measurement where final conversion result is the differential voltage, V_{DIFF} , between the positive and negative ADC inputs, A1+ and A1–. The bipolar, ground-referenced input signal must be level-shifted and attenuated by the op amp so that the output is biased to $V_{REF} / 2$ and has a differential voltage that is within the $\pm V_{REF} / 2$ input range of the ADC. The transfer function for the op-amp circuit simplifies to [Equation 4](#).

$$A1+ = \left(\frac{R_3}{R_2 + R_3} \right) V_{REF} + \left(\frac{R_2 \parallel R_3}{R_1} \right) V_{IN}$$

where

- $R_1 = R_4$
 - $R_5 = R_2 \parallel R_3$
- (4)

The voltage applied to the negative ADC input, A1–, is based on the resistor divider formed by R6 and R7 and is set to $V_{REF} / 2$ by setting R6 equal to R7, as shown in [Equation 5](#).

$$A1- = \left(\frac{R_7}{R_6 + R_7} \right) V_{REF} = \frac{V_{REF}}{2}$$
(5)

10.2.1.2.1 Op Amp Level-Shift Design

The ratio of R_2 , R_3 , and the V_{REF} voltage determines the voltage on the output of the op amp when the differential input is 0 V. Select the components so that V_{OUT} is equal to the $V_{REF} / 2$ voltage when V_{IN} is equal to 0 V, as shown in [Equation 6](#).

$$A1+ = \frac{V_{REF}}{2} = \left(\frac{R_3}{R_2 + R_3} \right) V_{REF}$$

where

- $V_{IN} = 0$ V
 - $R_2 = R_3$
- (6)

Solve for the value of R_5 by setting R_3 equal to R_2 in [Equation 4](#), as shown in [Equation 7](#):

$$R_5 = \left(\frac{R_2 \cdot R_2}{R_2 + R_2} \right) = \frac{R_2^2}{2 \cdot R_2} = \frac{R_2}{2}$$
(7)

10.2.1.2.2 Differential Input Attenuator Design

V_{DIFF} is the difference between the two inputs, as shown in [Equation 8](#):

$$V_{DIFF} = (A1+) - (A1-) = \left(\frac{R_3}{R_2 + R_3} \right) V_{REF} + \left(\frac{R_2 \parallel R_3}{R_1} \right) V_{IN} - \frac{V_{REF}}{2}$$
(8)

Typical Applications (continued)

When the ratio of R_3 and R_2 equals the ratio of R_7 and R_6 , [Equation 8](#) simplifies to [Equation 10](#).

That is, if:

$$\left(\frac{R_3}{R_2 + R_3}\right)V_{REF} = \left(\frac{R_7}{R_6 + R_7}\right)V_{REF} = \frac{1}{2}V_{REF} \quad (9)$$

Then:

$$V_{DIFF} = \left(\frac{R_2 \parallel R_3}{R_1}\right)V_{IN} \quad (10)$$

Determine the ratio of R_1 , R_2 , and R_3 by setting $A1+$ equal to the maximum V_{DIFF} for a full-scale positive or negative input voltage, V_{IN_MAX} , as shown in [Equation 11](#):

$$A1+ = V_{DIFF_MAX} = \left(\frac{R_2 \parallel R_3}{R_1}\right)V_{IN_MAX} \quad (11)$$

R_2 equals R_3 ; therefore, [Equation 11](#) simplifies to $R_2 / 2$, resulting in [Equation 12](#):

$$V_{DIFF_MAX} = \left(\frac{R_2}{2 \cdot R_1}\right)V_{IN_MAX} \quad (12)$$

10.2.1.2.3 Input Filtering

Both inputs feature first-order, low-pass, antialiasing filters that limit the bandwidth and noise of the input signals applied to the ADC. The $A1+$ filter is formed by R_8 and C_1 and the equation for the -3 -dB cutoff frequency is shown in [Equation 13](#):

$$f_{-3dB_A1+} = \frac{1}{2 \cdot \pi \cdot R_8 \cdot C_1} \quad (13)$$

The $A1-$ input filter is formed by C_2 and the parallel combination of the R_6 and R_7 resistors, as shown in [Equation 14](#):

$$f_{-3dB_A1-} = \frac{1}{2 \cdot \pi \cdot \left(\frac{R_6}{2}\right) \cdot C_2} \quad (14)$$

10.2.1.2.4 Component Selection

10.2.1.2.4.1 Voltage References

The REF33xx series of precision low-power voltage references pair well with the low power consumption of the [MSP430](#), while achieving the target accuracy goals. The 16-bit converter in the [MSP430F2013](#) accepts an external reference voltage from 1 V to 1.5 V with a typical reference input of 1.25 V, as shown in [Table 1](#).

Table 1. SD16_A, External Reference Input (MSP430F20x3)⁽¹⁾

PARAMETER	TEST CONDITIONS	MIN	TYP	MAX	UNIT
$V_{REF(I)}$ Input voltage range	VCC = 3 V, SD16REFON = 0	1	1.25	1.5	V
$I_{REF(I)}$ Input current	VCC = 3 V, SD16REFON = 0			50	nA

(1) Over recommended ranges of supply voltage and operating free-air temperature (unless otherwise noted).

The REF3312 provides the desired 1.25-V reference voltage for the MSP430 ADC. The accuracy of the REF3312 output, shown in the [Electrical Characteristics](#), directly affects the accuracy of the entire system and must be less than the desired unadjusted error goals. The REF3312 maximum $\pm 0.15\%$ initial accuracy specification is equal to the unadjusted error design goal of 0.15%, indicating that most of the error budget in this design must be devoted to the reference accuracy.

The 3.3-V system supply voltage that powers the MSP430 can also supply other devices, and therefore may have regulation and noise issues. The REF3330 creates an accurate and stable 3.0 V output used by the op amp, REF3312, and other low-power analog circuitry. The REF33xx series has a drop-output voltage of $V_{OUT} + 200$ mV; therefore, as long as the input supply remains above 3.2 V, the REF3330 produces a regulated 3.0 V output. The output current for the REF33xx series is specified at ± 5 mA, as shown in [Figure 9](#), and is sufficient for the REF3312 and a low-power op amp.

10.2.1.2.4.2 Op Amp

The [OPA317](#) op amp is used because of low offset voltage, low offset voltage drift, CMRR, and low power consumption. The dc specifications for the OPA317 can be seen in the [OPA317 data sheet, SBOS682](#), available for download from www.ti.com. The maximum offset of 100 μ V accounts for only 0.001% of the full-scale signal, and the low-drift reduces temperature drift effects. Therefore, as previously mentioned, most of the error in this design is from the reference accuracy and passive component tolerances.

10.2.1.2.5 Input Attenuation and Level Shifting

For this design, the bipolar ± 5 -V input must be attenuated and level shifted so the differential voltage is within the input range of $\pm V_{REF} / 2$, or ± 0.625 V. The accuracy of the op amp output and ADC input may degrade near the supply rails and V_{REF} voltage, so the output is designed to produce a 0.125 V to 1.125 V output, or ± 0.5 V for a ± 5 V input. Scaling the output this way also increases the allowable input range to ± 6 V, and allows for some underscale and overscale voltage measurement and protection.

Use [Equation 12](#) to scale the ± 5 -V input to a ± 0.5 -V differential voltage, as shown in [Equation 15](#).

$$0.5 \text{ V} = \left(\frac{R_2}{2 \cdot 100 \text{ k}\Omega} \right) \cdot 5 \text{ V}$$

where

- $R_1 = R_4 = 100 \text{ k}\Omega$ (15)

R_1 and R_4 dominate the input impedance for this design and are therefore selected to be 100 k Ω . Higher values can be selected to increase the input impedance at the expense of input noise.

With the value for R_2 and R_3 selected as 20 k Ω , the value for R_5 is calculated, as shown in [Equation 16](#):

$$R_5 = \left(\frac{R_2}{2} \right) = 10 \text{ k}\Omega$$

where

- $R_2 = R_3 = 20 \text{ k}\Omega$ (16)

In order for $A1-$ to equal to $V_{REF} / 2$, R_6 must equal R_7 . Two 47-k Ω resistors are used in order to conserve power without creating an impedance too weak to drive the ADC input.

10.2.1.2.6 Input Filtering

The MSP430 ADC is configured to run from the 1.1-MHz SMCLK with an oversampling rate (OSR) of 256, yielding a sample rate of roughly 4.3 kHz. The input filter cutoff frequency is set to 1 kHz in order to limit the input signal bandwidth, as shown in [Equation 17](#). R_8 is 1 k Ω in order to provide isolation from the capacitive load of the low-pass filter, thereby reducing stability concerns.

$$f_{-3\text{dB}_{A1+}} = 1 \text{ kHz} = \frac{1}{2 \cdot \pi \cdot R_8 \cdot C_1}$$

where

- $C_1 = \frac{1}{2 \cdot \pi \cdot 1 \text{ k}\Omega \cdot 1 \text{ kHz}} = 159 \text{ nF}$ (17)

Reduce C_1 to 150 nF so that it is a standard value.

The $A1-$ input of the delta-sigma ($\Delta\Sigma$) converter is not buffered, and therefore requires a large capacitor to supply the charge for the internal sampling capacitor. A 47- μ F capacitor is selected, resulting in the cutoff frequency illustrated in [Equation 18](#).

$$f_{-3dB_A1-} = \frac{1}{2 \cdot \pi \cdot \left(\frac{R_6}{2}\right) \cdot C_2} = 0.144 \text{ Hz} \quad (18)$$

In applications that cannot tolerate such a low-frequency cutoff, and therefore a long start-up time, buffer the A1- input with another OPA317 to properly drive the ADC input with a lower-input capacitor.

10.2.1.2.7 Passive Component Tolerances and Materials

Resistors R₁, R₂, R₃, R₄, R₅, R₆, and R₇ directly affect the accuracy of the circuit. To meet the unadjusted accuracy goals of 0.2%, the resistors used are 0.1%. Select 0.1% resistors for the construction of the difference amplifier circuit to provide a common-mode rejection ratio (CMRR) of at least 60 dB.

10.2.1.3 Application Curves

10.2.1.3.1 DC Performance

The measured dc performance and calculated error of the circuit is shown in Figure 20 and Figure 21, respectively. By applying a two-point gain and offset calibration over the specified ±5-V input range, the calibrated error is shown in Figure 22. The uncalibrated results show errors of 138 μV, or 0.0138%FSR. The calibrated results with a simple two-point calibration show errors under 5 μV, or 0.0005%FSR, in the specified input range of ±5 V.

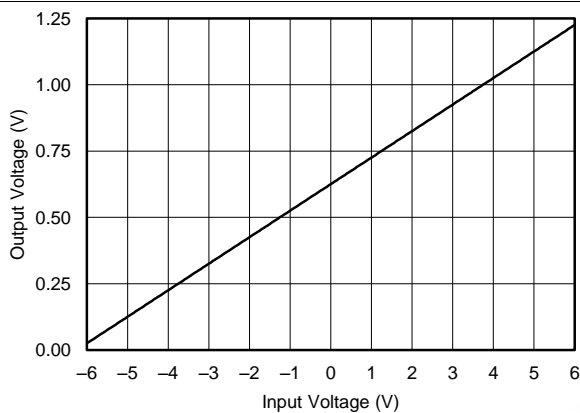

Figure 20. Measured DC Transfer Function with ±6-V Input

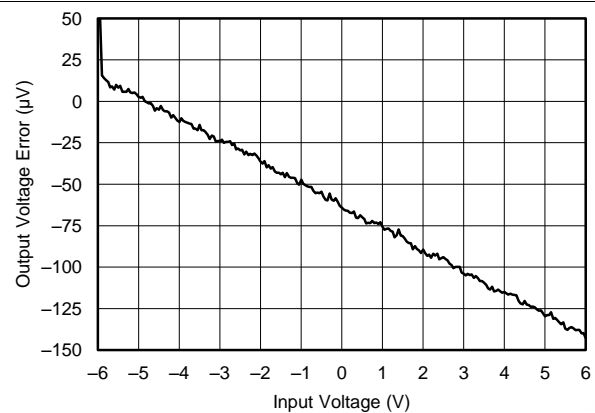

Figure 21. Measured Output Error with ±6-V Input

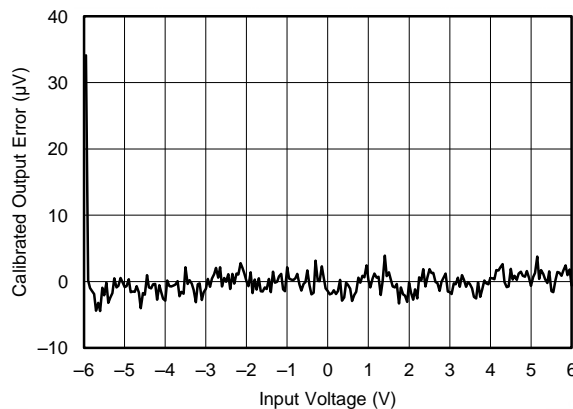
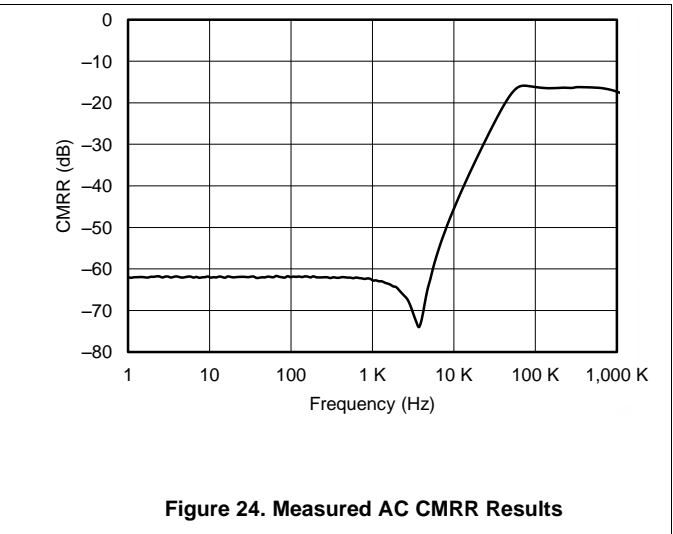
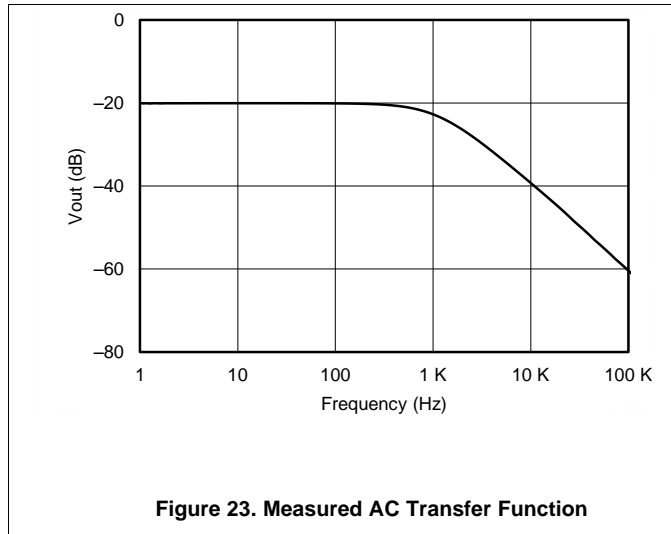

Figure 22. Calibrated Output Error with ±6-V Input

10.2.1.3.2 AC Performance

The ac transfer function for the attenuation and level-shifting circuit is shown in [Figure 23](#).

The low-frequency ac CMRR performance is measured to be 62 dB, as shown in [Figure 24](#).



11 Power-Supply Recommendations

The REF33xx family of voltage references features extremely low dropout voltage, except for the REF3312. The REF3312 has a minimum supply requirement of 1.7 V. These references can be operated with a supply 110 mV above the output voltage with a 5-mA load (typical). For loaded conditions, a typical dropout voltage versus load graph is illustrated in [Figure 4](#) of the *Typical Characteristics*.

If the supply voltage connected to the IN pin is rapidly moved when the REF33xx is connected to a capacitive load, a reverse voltage can discharge through the OUT pin and into the REF33xx. This voltage does not damage the REF33xx, provided that the voltage is less than or equal to 5 V.

12 Layout

12.1 Layout Guidelines

For optimal performance of this design, follow standard printed circuit board (PCB) layout guidelines, including proper decoupling close to all integrated circuits and adequate power and ground connections with large copper pours. Select a PCB size with connectors that connect directly to the MSP430 LaunchPad™.

Figure 25 shows an example of a PCB layout for a data acquisition system using the REF33xx.

Some key considerations are:

- Connect a low-ESR, 1- μ F ceramic capacitor at the IN pin for bypass, and a 0.1- μ F to 10- μ F ceramic capacitor at the OUT pin for stability of the REF33xx.
- Decouple other active devices in the system per the device specifications.
- Use a solid ground plane helps distribute heat and reduces EMI noise pickup.
- Place the external components as close to the device as possible. This configuration prevents parasitic errors (such as the Seebeck effect) from occurring.
- Minimize trace length between the reference and bias connections to the ADC to reduce noise pickup.
- Do not run sensitive analog traces in parallel with digital traces. Avoid crossing digital and analog traces if possible, and only make perpendicular crossings when absolutely necessary.

12.2 Layout Example

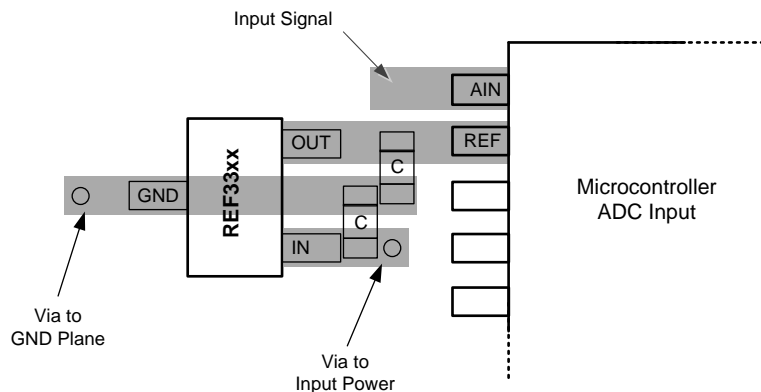

Figure 25. Layout Example

13 Device and Documentation Support

13.1 Documentation Support

13.1.1 Related Documentation

[OPAx333 1.8-V, microPower, CMOS Operational Amplifiers, Zero-Drift Series](#) (SBOS351)

[OPAx363, OPAx364 1.8-V, 7-MHz, 90-dB CMRR, Single-Supply, Rail-to-Rail I/O Operational Amplifier](#) (SBOS259)

[OPAx369 1.8V, 700nA, Zero-Crossover Rail-to-Rail I/O Operational Amplifier](#) (SBOS414)

[INA159 Precision, Gain of 0.2 Level Translation Difference Amplifier](#) (SBOS333)

13.2 Related Links

The table below lists quick access links. Categories include technical documents, support and community resources, tools and software, and quick access to sample or buy.

Table 2. Related Links

PARTS	PRODUCT FOLDER	SAMPLE & BUY	TECHNICAL DOCUMENTS	TOOLS & SOFTWARE	SUPPORT & COMMUNITY
REF3312	Click here	Click here	Click here	Click here	Click here
REF3318	Click here	Click here	Click here	Click here	Click here
REF3320	Click here	Click here	Click here	Click here	Click here
REF3325	Click here	Click here	Click here	Click here	Click here
REF3330	Click here	Click here	Click here	Click here	Click here
REF3333	Click here	Click here	Click here	Click here	Click here

13.3 Receiving Notification of Documentation Updates

To receive notification of documentation updates, navigate to the device product folder on ti.com. In the upper right corner, click on *Alert me* to register and receive a weekly digest of any product information that has changed. For change details, review the revision history included in any revised document.

13.4 Community Resources

The following links connect to TI community resources. Linked contents are provided "AS IS" by the respective contributors. They do not constitute TI specifications and do not necessarily reflect TI's views; see TI's [Terms of Use](#).

TI E2E™ Online Community *TI's Engineer-to-Engineer (E2E) Community*. Created to foster collaboration among engineers. At e2e.ti.com, you can ask questions, share knowledge, explore ideas and help solve problems with fellow engineers.

Design Support *TI's Design Support* Quickly find helpful E2E forums along with design support tools and contact information for technical support.

13.5 Trademarks

LaunchPad, E2E are trademarks of Texas Instruments.
All other trademarks are the property of their respective owners.

13.6 Electrostatic Discharge Caution



This integrated circuit can be damaged by ESD. Texas Instruments recommends that all integrated circuits be handled with appropriate precautions. Failure to observe proper handling and installation procedures can cause damage.

ESD damage can range from subtle performance degradation to complete device failure. Precision integrated circuits may be more susceptible to damage because very small parametric changes could cause the device not to meet its published specifications.

13.7 Glossary

[SLYZ022](#) — *TI Glossary*.

This glossary lists and explains terms, acronyms, and definitions.

14 Mechanical, Packaging, and Orderable Information

The following pages include mechanical packaging and orderable information. This information is the most current data available for the designated devices. This data is subject to change without notice and revision of this document. For browser-based versions of this data sheet, refer to the left-hand navigation.

PACKAGING INFORMATION

Orderable Device	Status (1)	Package Type	Package Drawing	Pins	Package Qty	Eco Plan (2)	Lead/Ball Finish (6)	MSL Peak Temp (3)	Op Temp (°C)	Device Marking (4/5)	Samples
REF3312AIDBZR	ACTIVE	SOT-23	DBZ	3	3000	Green (RoHS & no Sb/Br)	CU NIPDAU	Level-2-260C-1 YEAR	-40 to 125	R33A	Samples
REF3312AIDBZRG4	ACTIVE	SOT-23	DBZ	3	3000	Green (RoHS & no Sb/Br)	CU NIPDAU	Level-2-260C-1 YEAR	-40 to 125	R33A	Samples
REF3312AIDBZT	ACTIVE	SOT-23	DBZ	3	250	Green (RoHS & no Sb/Br)	CU NIPDAU	Level-2-260C-1 YEAR	-40 to 125	R33A	Samples
REF3312AIDBZTG4	ACTIVE	SOT-23	DBZ	3	250	Green (RoHS & no Sb/Br)	CU NIPDAU	Level-2-260C-1 YEAR	-40 to 125	R33A	Samples
REF3312AIDCKR	ACTIVE	SC70	DCK	3	3000	Green (RoHS & no Sb/Br)	CU NIPDAU	Level-2-260C-1 YEAR	-40 to 125	R12	Samples
REF3312AIDCKRG4	ACTIVE	SC70	DCK	3	3000	Green (RoHS & no Sb/Br)	CU NIPDAU	Level-2-260C-1 YEAR	-40 to 125	R12	Samples
REF3312AIDCKT	ACTIVE	SC70	DCK	3	250	Green (RoHS & no Sb/Br)	CU NIPDAU	Level-2-260C-1 YEAR	-40 to 125	R12	Samples
REF3312AIDCKTG4	ACTIVE	SC70	DCK	3	250	Green (RoHS & no Sb/Br)	CU NIPDAU	Level-2-260C-1 YEAR	-40 to 125	R12	Samples
REF3312AIRSER	ACTIVE	UQFN	RSE	8	5000	Green (RoHS & no Sb/Br)	CU NIPDAU	Level-1-260C-UNLIM	-40 to 125	5G	Samples
REF3312AIRSET	ACTIVE	UQFN	RSE	8	250	Green (RoHS & no Sb/Br)	CU NIPDAU	Level-1-260C-UNLIM	-40 to 125	5G	Samples
REF3318AIDBZR	ACTIVE	SOT-23	DBZ	3	3000	Green (RoHS & no Sb/Br)	CU NIPDAU	Level-2-260C-1 YEAR	-40 to 125	R33B	Samples
REF3318AIDBZT	ACTIVE	SOT-23	DBZ	3	250	Green (RoHS & no Sb/Br)	CU NIPDAU	Level-2-260C-1 YEAR	-40 to 125	R33B	Samples
REF3318AIDBZTG4	ACTIVE	SOT-23	DBZ	3	250	Green (RoHS & no Sb/Br)	CU NIPDAU	Level-2-260C-1 YEAR	-40 to 125	R33B	Samples
REF3318AIDCKR	ACTIVE	SC70	DCK	3	3000	Green (RoHS & no Sb/Br)	CU NIPDAU	Level-2-260C-1 YEAR	-40 to 125	R18	Samples
REF3318AIDCKRG4	ACTIVE	SC70	DCK	3	3000	Green (RoHS & no Sb/Br)	CU NIPDAU	Level-2-260C-1 YEAR	-40 to 125	R18	Samples
REF3318AIDCKT	ACTIVE	SC70	DCK	3	250	Green (RoHS & no Sb/Br)	CU NIPDAU	Level-2-260C-1 YEAR	-40 to 125	R18	Samples
REF3318AIDCKTG4	ACTIVE	SC70	DCK	3	250	Green (RoHS & no Sb/Br)	CU NIPDAU	Level-2-260C-1 YEAR	-40 to 125	R18	Samples

Orderable Device	Status (1)	Package Type	Package Drawing	Pins	Package Qty	Eco Plan (2)	Lead/Ball Finish (6)	MSL Peak Temp (3)	Op Temp (°C)	Device Marking (4/5)	Samples
REF3320AIDBZR	ACTIVE	SOT-23	DBZ	3	3000	Green (RoHS & no Sb/Br)	CU NIPDAU	Level-2-260C-1 YEAR	-40 to 125	R33C	Samples
REF3320AIDBZRG4	ACTIVE	SOT-23	DBZ	3	3000	Green (RoHS & no Sb/Br)	CU NIPDAU	Level-2-260C-1 YEAR	-40 to 125	R33C	Samples
REF3320AIDBZT	ACTIVE	SOT-23	DBZ	3	250	Green (RoHS & no Sb/Br)	CU NIPDAU	Level-2-260C-1 YEAR	-40 to 125	R33C	Samples
REF3320AIDBZTG4	ACTIVE	SOT-23	DBZ	3	250	Green (RoHS & no Sb/Br)	CU NIPDAU	Level-2-260C-1 YEAR	-40 to 125	R33C	Samples
REF3320AIDCKR	ACTIVE	SC70	DCK	3	3000	Green (RoHS & no Sb/Br)	CU NIPDAU	Level-2-260C-1 YEAR	-40 to 125	R20	Samples
REF3320AIDCKRG4	ACTIVE	SC70	DCK	3	3000	Green (RoHS & no Sb/Br)	CU NIPDAU	Level-2-260C-1 YEAR	-40 to 125	R20	Samples
REF3320AIDCKT	ACTIVE	SC70	DCK	3	250	Green (RoHS & no Sb/Br)	CU NIPDAU	Level-2-260C-1 YEAR	-40 to 125	R20	Samples
REF3320AIDCKTG4	ACTIVE	SC70	DCK	3	250	Green (RoHS & no Sb/Br)	CU NIPDAU	Level-2-260C-1 YEAR	-40 to 125	R20	Samples
REF3325AIDBZR	ACTIVE	SOT-23	DBZ	3	3000	Green (RoHS & no Sb/Br)	CU NIPDAU	Level-2-260C-1 YEAR	-40 to 125	R33D	Samples
REF3325AIDBZRG4	ACTIVE	SOT-23	DBZ	3	3000	Green (RoHS & no Sb/Br)	CU NIPDAU	Level-2-260C-1 YEAR	-40 to 125	R33D	Samples
REF3325AIDBZT	ACTIVE	SOT-23	DBZ	3	250	Green (RoHS & no Sb/Br)	CU NIPDAU	Level-2-260C-1 YEAR	-40 to 125	R33D	Samples
REF3325AIDBZTG4	ACTIVE	SOT-23	DBZ	3	250	Green (RoHS & no Sb/Br)	CU NIPDAU	Level-2-260C-1 YEAR	-40 to 125	R33D	Samples
REF3325AIDCKR	ACTIVE	SC70	DCK	3	3000	Green (RoHS & no Sb/Br)	CU NIPDAU	Level-2-260C-1 YEAR	-40 to 125	R25	Samples
REF3325AIDCKRG4	ACTIVE	SC70	DCK	3	3000	Green (RoHS & no Sb/Br)	CU NIPDAU	Level-2-260C-1 YEAR	-40 to 125	R25	Samples
REF3325AIDCKT	ACTIVE	SC70	DCK	3	250	Green (RoHS & no Sb/Br)	CU NIPDAU	Level-2-260C-1 YEAR	-40 to 125	R25	Samples
REF3325AIDCKTG4	ACTIVE	SC70	DCK	3	250	Green (RoHS & no Sb/Br)	CU NIPDAU	Level-2-260C-1 YEAR	-40 to 125	R25	Samples
REF3325AIRSER	ACTIVE	UQFN	RSE	8	5000	Green (RoHS & no Sb/Br)	CU NIPDAU	Level-1-260C-UNLIM	-40 to 125	GN	Samples
REF3330AIDBZR	ACTIVE	SOT-23	DBZ	3	3000	Green (RoHS & no Sb/Br)	CU NIPDAU	Level-2-260C-1 YEAR	-40 to 125	R33E	Samples

Orderable Device	Status (1)	Package Type	Package Drawing	Pins	Package Qty	Eco Plan (2)	Lead/Ball Finish (6)	MSL Peak Temp (3)	Op Temp (°C)	Device Marking (4/5)	Samples
REF3330AIDBZT	ACTIVE	SOT-23	DBZ	3	250	Green (RoHS & no Sb/Br)	CU NIPDAU	Level-2-260C-1 YEAR	-40 to 125	R33E	Samples
REF3330AIDBZTG4	ACTIVE	SOT-23	DBZ	3	250	Green (RoHS & no Sb/Br)	CU NIPDAU	Level-2-260C-1 YEAR	-40 to 125	R33E	Samples
REF3330AIDCKR	ACTIVE	SC70	DCK	3	3000	Green (RoHS & no Sb/Br)	CU NIPDAU	Level-2-260C-1 YEAR	-40 to 125	R30	Samples
REF3330AIDCKRG4	ACTIVE	SC70	DCK	3	3000	Green (RoHS & no Sb/Br)	CU NIPDAU	Level-2-260C-1 YEAR	-40 to 125	R30	Samples
REF3330AIDCKT	ACTIVE	SC70	DCK	3	250	Green (RoHS & no Sb/Br)	CU NIPDAU	Level-2-260C-1 YEAR	-40 to 125	R30	Samples
REF3330AIDCKTG4	ACTIVE	SC70	DCK	3	250	Green (RoHS & no Sb/Br)	CU NIPDAU	Level-2-260C-1 YEAR	-40 to 125	R30	Samples
REF3330AIRSER	ACTIVE	UQFN	RSE	8	5000	Green (RoHS & no Sb/Br)	CU NIPDAU	Level-1-260C-UNLIM	-40 to 125	EN	Samples
REF3333AIDBZR	ACTIVE	SOT-23	DBZ	3	3000	Green (RoHS & no Sb/Br)	CU NIPDAU	Level-2-260C-1 YEAR	-40 to 125	R33F	Samples
REF3333AIDBZRG4	ACTIVE	SOT-23	DBZ	3	3000	Green (RoHS & no Sb/Br)	CU NIPDAU	Level-2-260C-1 YEAR	-40 to 125	R33F	Samples
REF3333AIDBZT	ACTIVE	SOT-23	DBZ	3	250	Green (RoHS & no Sb/Br)	CU NIPDAU	Level-2-260C-1 YEAR	-40 to 125	R33F	Samples
REF3333AIDCKR	ACTIVE	SC70	DCK	3	3000	Green (RoHS & no Sb/Br)	CU NIPDAU	Level-2-260C-1 YEAR	-40 to 125	R33	Samples
REF3333AIDCKT	ACTIVE	SC70	DCK	3	250	Green (RoHS & no Sb/Br)	CU NIPDAU	Level-2-260C-1 YEAR	-40 to 125	R33	Samples
REF3333AIDCKTG4	ACTIVE	SC70	DCK	3	250	Green (RoHS & no Sb/Br)	CU NIPDAU	Level-2-260C-1 YEAR	-40 to 125	R33	Samples

(1) The marketing status values are defined as follows:

ACTIVE: Product device recommended for new designs.

LIFEBUY: TI has announced that the device will be discontinued, and a lifetime-buy period is in effect.

NRND: Not recommended for new designs. Device is in production to support existing customers, but TI does not recommend using this part in a new design.

PREVIEW: Device has been announced but is not in production. Samples may or may not be available.

OBSELETE: TI has discontinued the production of the device.

(2) **RoHS:** TI defines "RoHS" to mean semiconductor products that are compliant with the current EU RoHS requirements for all 10 RoHS substances, including the requirement that RoHS substance do not exceed 0.1% by weight in homogeneous materials. Where designed to be soldered at high temperatures, "RoHS" products are suitable for use in specified lead-free processes. TI may reference these types of products as "Pb-Free".

RoHS Exempt: TI defines "RoHS Exempt" to mean products that contain lead but are compliant with EU RoHS pursuant to a specific EU RoHS exemption.

Green: TI defines "Green" to mean the content of Chlorine (Cl) and Bromine (Br) based flame retardants meet JS709B low halogen requirements of ≤ 1000 ppm threshold. Antimony trioxide based flame retardants must also meet the ≤ 1000 ppm threshold requirement.

(3) MSL, Peak Temp. - The Moisture Sensitivity Level rating according to the JEDEC industry standard classifications, and peak solder temperature.

(4) There may be additional marking, which relates to the logo, the lot trace code information, or the environmental category on the device.

(5) Multiple Device Markings will be inside parentheses. Only one Device Marking contained in parentheses and separated by a "~" will appear on a device. If a line is indented then it is a continuation of the previous line and the two combined represent the entire Device Marking for that device.

(6) Lead/Ball Finish - Orderable Devices may have multiple material finish options. Finish options are separated by a vertical ruled line. Lead/Ball Finish values may wrap to two lines if the finish value exceeds the maximum column width.

Important Information and Disclaimer: The information provided on this page represents TI's knowledge and belief as of the date that it is provided. TI bases its knowledge and belief on information provided by third parties, and makes no representation or warranty as to the accuracy of such information. Efforts are underway to better integrate information from third parties. TI has taken and continues to take reasonable steps to provide representative and accurate information but may not have conducted destructive testing or chemical analysis on incoming materials and chemicals. TI and TI suppliers consider certain information to be proprietary, and thus CAS numbers and other limited information may not be available for release.

In no event shall TI's liability arising out of such information exceed the total purchase price of the TI part(s) at issue in this document sold by TI to Customer on an annual basis.

TAPE AND REEL INFORMATION



QUADRANT ASSIGNMENTS FOR PIN 1 ORIENTATION IN TAPE



*All dimensions are nominal

Device	Package Type	Package Drawing	Pins	SPQ	Reel Diameter (mm)	Reel Width W1 (mm)	A0 (mm)	B0 (mm)	K0 (mm)	P1 (mm)	W (mm)	Pin1 Quadrant
REF3312AIDBZR	SOT-23	DBZ	3	3000	179.0	8.4	3.15	2.95	1.22	4.0	8.0	Q3
REF3312AIDBZT	SOT-23	DBZ	3	250	179.0	8.4	3.15	2.95	1.22	4.0	8.0	Q3
REF3312AIDCKR	SC70	DCK	3	3000	179.0	8.4	2.4	2.4	1.19	4.0	8.0	Q3
REF3312AIDCKT	SC70	DCK	3	250	179.0	8.4	2.4	2.4	1.19	4.0	8.0	Q3
REF3312AIRSER	UQFN	RSE	8	5000	180.0	9.5	1.7	1.7	0.75	4.0	8.0	Q2
REF3312AIRSET	UQFN	RSE	8	250	180.0	9.5	1.7	1.7	0.75	4.0	8.0	Q2
REF3318AIDBZR	SOT-23	DBZ	3	3000	179.0	8.4	3.15	2.95	1.22	4.0	8.0	Q3
REF3318AIDBZT	SOT-23	DBZ	3	250	179.0	8.4	3.15	2.95	1.22	4.0	8.0	Q3
REF3318AIDCKR	SC70	DCK	3	3000	179.0	8.4	2.4	2.4	1.19	4.0	8.0	Q3
REF3318AIDCKT	SC70	DCK	3	250	179.0	8.4	2.4	2.4	1.19	4.0	8.0	Q3
REF3320AIDBZR	SOT-23	DBZ	3	3000	179.0	8.4	3.15	2.95	1.22	4.0	8.0	Q3
REF3320AIDBZT	SOT-23	DBZ	3	250	179.0	8.4	3.15	2.95	1.22	4.0	8.0	Q3
REF3320AIDCKR	SC70	DCK	3	3000	179.0	8.4	2.4	2.4	1.19	4.0	8.0	Q3
REF3320AIDCKT	SC70	DCK	3	250	179.0	8.4	2.4	2.4	1.19	4.0	8.0	Q3
REF3325AIDBZR	SOT-23	DBZ	3	3000	179.0	8.4	3.15	2.95	1.22	4.0	8.0	Q3
REF3325AIDBZT	SOT-23	DBZ	3	250	179.0	8.4	3.15	2.95	1.22	4.0	8.0	Q3
REF3325AIDCKR	SC70	DCK	3	3000	179.0	8.4	2.4	2.4	1.19	4.0	8.0	Q3
REF3325AIDCKT	SC70	DCK	3	250	179.0	8.4	2.4	2.4	1.19	4.0	8.0	Q3

Device	Package Type	Package Drawing	Pins	SPQ	Reel Diameter (mm)	Reel Width W1 (mm)	A0 (mm)	B0 (mm)	K0 (mm)	P1 (mm)	W (mm)	Pin1 Quadrant
REF3325AIRSER	UQFN	RSE	8	5000	180.0	9.5	1.7	1.7	0.75	4.0	8.0	Q2
REF3330AIDBZR	SOT-23	DBZ	3	3000	179.0	8.4	3.15	2.95	1.22	4.0	8.0	Q3
REF3330AIDBZT	SOT-23	DBZ	3	250	179.0	8.4	3.15	2.95	1.22	4.0	8.0	Q3
REF3330AIDCKR	SC70	DCK	3	3000	179.0	8.4	2.4	2.4	1.19	4.0	8.0	Q3
REF3330AIDCKT	SC70	DCK	3	250	179.0	8.4	2.4	2.4	1.19	4.0	8.0	Q3
REF3330AIRSER	UQFN	RSE	8	5000	180.0	9.5	1.7	1.7	0.75	4.0	8.0	Q2
REF3333AIDBZR	SOT-23	DBZ	3	3000	179.0	8.4	3.15	2.95	1.22	4.0	8.0	Q3
REF3333AIDBZT	SOT-23	DBZ	3	250	179.0	8.4	3.15	2.95	1.22	4.0	8.0	Q3
REF3333AIDCKR	SC70	DCK	3	3000	179.0	8.4	2.4	2.4	1.19	4.0	8.0	Q3
REF3333AIDCKT	SC70	DCK	3	250	179.0	8.4	2.4	2.4	1.19	4.0	8.0	Q3

TAPE AND REEL BOX DIMENSIONS

*All dimensions are nominal

Device	Package Type	Package Drawing	Pins	SPQ	Length (mm)	Width (mm)	Height (mm)
REF3312AIDBZR	SOT-23	DBZ	3	3000	195.0	200.0	45.0
REF3312AIDBZT	SOT-23	DBZ	3	250	195.0	200.0	45.0
REF3312AIDCKR	SC70	DCK	3	3000	195.0	200.0	45.0
REF3312AIDCKT	SC70	DCK	3	250	195.0	200.0	45.0
REF3312AIRSER	UQFN	RSE	8	5000	184.0	184.0	19.0
REF3312AIRSET	UQFN	RSE	8	250	184.0	184.0	19.0
REF3318AIDBZR	SOT-23	DBZ	3	3000	195.0	200.0	45.0

Device	Package Type	Package Drawing	Pins	SPQ	Length (mm)	Width (mm)	Height (mm)
REF3318AIDBZT	SOT-23	DBZ	3	250	195.0	200.0	45.0
REF3318AIDCKR	SC70	DCK	3	3000	195.0	200.0	45.0
REF3318AIDCKT	SC70	DCK	3	250	195.0	200.0	45.0
REF3320AIDBZR	SOT-23	DBZ	3	3000	195.0	200.0	45.0
REF3320AIDBZT	SOT-23	DBZ	3	250	195.0	200.0	45.0
REF3320AIDCKR	SC70	DCK	3	3000	195.0	200.0	45.0
REF3320AIDCKT	SC70	DCK	3	250	195.0	200.0	45.0
REF3325AIDBZR	SOT-23	DBZ	3	3000	195.0	200.0	45.0
REF3325AIDBZT	SOT-23	DBZ	3	250	195.0	200.0	45.0
REF3325AIDCKR	SC70	DCK	3	3000	195.0	200.0	45.0
REF3325AIDCKT	SC70	DCK	3	250	195.0	200.0	45.0
REF3325AIRSER	UQFN	RSE	8	5000	184.0	184.0	19.0
REF3330AIDBZR	SOT-23	DBZ	3	3000	195.0	200.0	45.0
REF3330AIDBZT	SOT-23	DBZ	3	250	195.0	200.0	45.0
REF3330AIDCKR	SC70	DCK	3	3000	195.0	200.0	45.0
REF3330AIDCKT	SC70	DCK	3	250	195.0	200.0	45.0
REF3330AIRSER	UQFN	RSE	8	5000	184.0	184.0	19.0
REF3333AIDBZR	SOT-23	DBZ	3	3000	195.0	200.0	45.0
REF3333AIDBZT	SOT-23	DBZ	3	250	195.0	200.0	45.0
REF3333AIDCKR	SC70	DCK	3	3000	195.0	200.0	45.0
REF3333AIDCKT	SC70	DCK	3	250	195.0	200.0	45.0

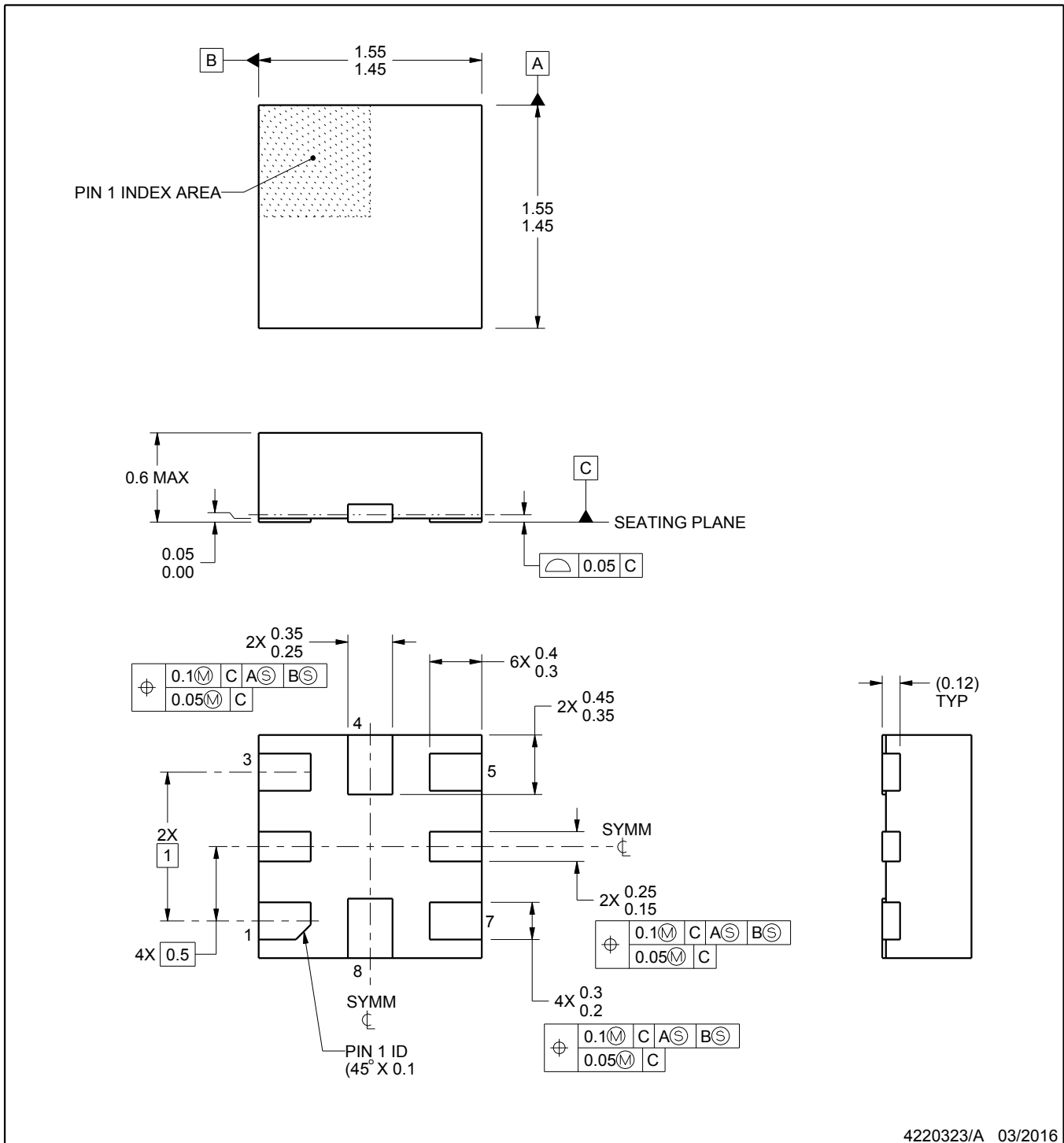
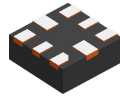

4220323/A 03/2016

NOTES:

1. All linear dimensions are in millimeters. Any dimensions in parenthesis are for reference only. Dimensioning and tolerancing per ASME Y14.5M.
2. This drawing is subject to change without notice.

EXAMPLE BOARD LAYOUT

RSE0008A

UQFN - 0.6 mm max height

PLASTIC QUAD FLATPACK - NO LEAD

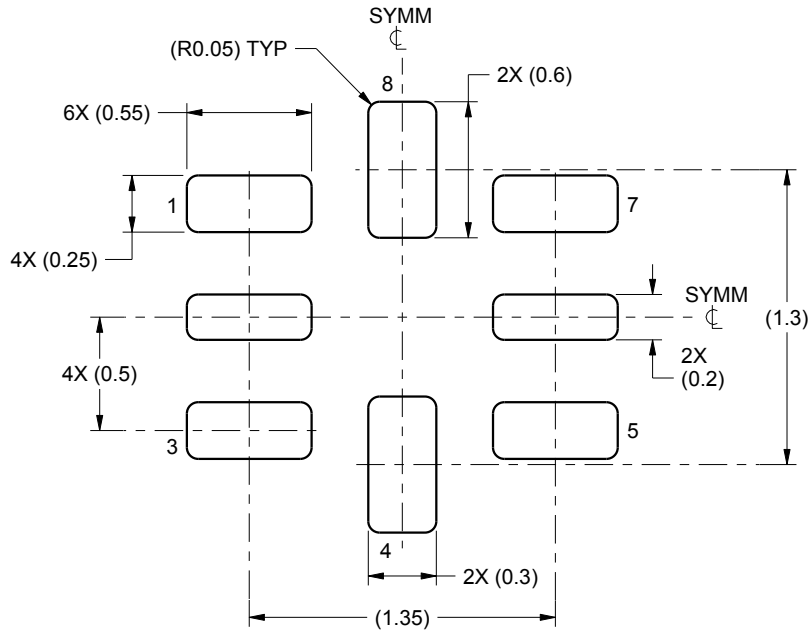

LAND PATTERN EXAMPLE
SCALE:30X

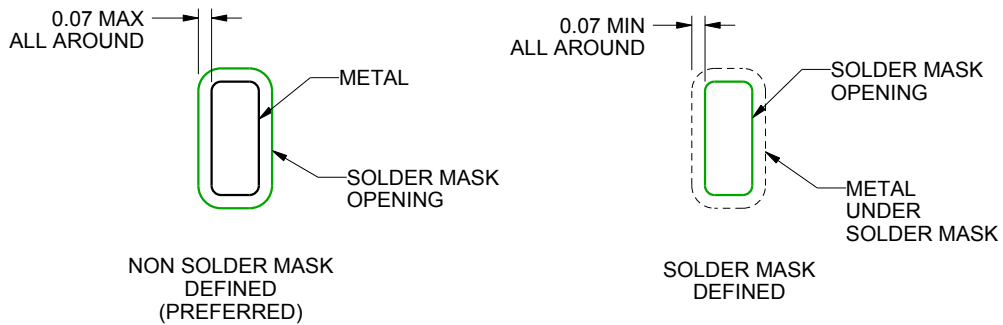

SOLDER MASK DETAILS
NOT TO SCALE

4220323/A 03/2016

NOTES: (continued)

3. For more information, see Texas Instruments literature number SLUA271 (www.ti.com/lit/slua271).

EXAMPLE STENCIL DESIGN

RSE0008A

UQFN - 0.6 mm max height

PLASTIC QUAD FLATPACK - NO LEAD

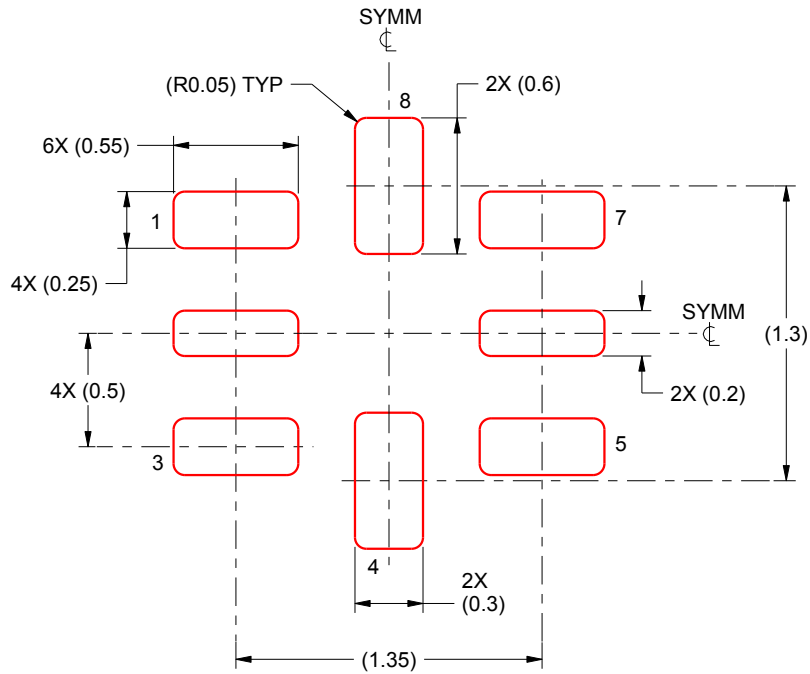

SOLDER PASTE EXAMPLE
BASED ON 0.1 mm THICKNESS
SCALE: 30X

4220323/A 03/2016

NOTES: (continued)

5. Laser cutting apertures with trapezoidal walls and rounded corners may offer better paste release. IPC-7525 may have alternate design recommendations.

GENERIC PACKAGE VIEW

DBZ 3

SOT-23 - 1.12 mm max height

SMALL OUTLINE TRANSISTOR



Images above are just a representation of the package family, actual package may vary.
Refer to the product data sheet for package details.

4203227/C

DBZ0003A



PACKAGE OUTLINE

SOT-23 - 1.12 mm max height

SMALL OUTLINE TRANSISTOR



4214838/C 04/2017

NOTES:

1. All linear dimensions are in millimeters. Any dimensions in parenthesis are for reference only. Dimensioning and tolerancing per ASME Y14.5M.
2. This drawing is subject to change without notice.
3. Reference JEDEC registration TO-236, except minimum foot length.

EXAMPLE BOARD LAYOUT

DBZ0003A

SOT-23 - 1.12 mm max height

SMALL OUTLINE TRANSISTOR



LAND PATTERN EXAMPLE
SCALE:15X



SOLDER MASK DETAILS

4214838/C 04/2017

NOTES: (continued)

4. Publication IPC-7351 may have alternate designs.
5. Solder mask tolerances between and around signal pads can vary based on board fabrication site.

EXAMPLE STENCIL DESIGN

DBZ0003A

SOT-23 - 1.12 mm max height

SMALL OUTLINE TRANSISTOR



SOLDER PASTE EXAMPLE
BASED ON 0.125 THICK STENCIL
SCALE:15X

4214838/C 04/2017

NOTES: (continued)

6. Laser cutting apertures with trapezoidal walls and rounded corners may offer better paste release. IPC-7525 may have alternate design recommendations.
7. Board assembly site may have different recommendations for stencil design.

IMPORTANT NOTICE

Texas Instruments Incorporated (TI) reserves the right to make corrections, enhancements, improvements and other changes to its semiconductor products and services per JESD46, latest issue, and to discontinue any product or service per JESD48, latest issue. Buyers should obtain the latest relevant information before placing orders and should verify that such information is current and complete.

TI's published terms of sale for semiconductor products (<http://www.ti.com/sc/docs/stdterms.htm>) apply to the sale of packaged integrated circuit products that TI has qualified and released to market. Additional terms may apply to the use or sale of other types of TI products and services.

Reproduction of significant portions of TI information in TI data sheets is permissible only if reproduction is without alteration and is accompanied by all associated warranties, conditions, limitations, and notices. TI is not responsible or liable for such reproduced documentation. Information of third parties may be subject to additional restrictions. Resale of TI products or services with statements different from or beyond the parameters stated by TI for that product or service voids all express and any implied warranties for the associated TI product or service and is an unfair and deceptive business practice. TI is not responsible or liable for any such statements.

Buyers and others who are developing systems that incorporate TI products (collectively, "Designers") understand and agree that Designers remain responsible for using their independent analysis, evaluation and judgment in designing their applications and that Designers have full and exclusive responsibility to assure the safety of Designers' applications and compliance of their applications (and of all TI products used in or for Designers' applications) with all applicable regulations, laws and other applicable requirements. Designer represents that, with respect to their applications, Designer has all the necessary expertise to create and implement safeguards that (1) anticipate dangerous consequences of failures, (2) monitor failures and their consequences, and (3) lessen the likelihood of failures that might cause harm and take appropriate actions. Designer agrees that prior to using or distributing any applications that include TI products, Designer will thoroughly test such applications and the functionality of such TI products as used in such applications.

TI's provision of technical, application or other design advice, quality characterization, reliability data or other services or information, including, but not limited to, reference designs and materials relating to evaluation modules, (collectively, "TI Resources") are intended to assist designers who are developing applications that incorporate TI products; by downloading, accessing or using TI Resources in any way, Designer (individually or, if Designer is acting on behalf of a company, Designer's company) agrees to use any particular TI Resource solely for this purpose and subject to the terms of this Notice.

TI's provision of TI Resources does not expand or otherwise alter TI's applicable published warranties or warranty disclaimers for TI products, and no additional obligations or liabilities arise from TI providing such TI Resources. TI reserves the right to make corrections, enhancements, improvements and other changes to its TI Resources. TI has not conducted any testing other than that specifically described in the published documentation for a particular TI Resource.

Designer is authorized to use, copy and modify any individual TI Resource only in connection with the development of applications that include the TI product(s) identified in such TI Resource. NO OTHER LICENSE, EXPRESS OR IMPLIED, BY ESTOPPEL OR OTHERWISE TO ANY OTHER TI INTELLECTUAL PROPERTY RIGHT, AND NO LICENSE TO ANY TECHNOLOGY OR INTELLECTUAL PROPERTY RIGHT OF TI OR ANY THIRD PARTY IS GRANTED HEREIN, including but not limited to any patent right, copyright, mask work right, or other intellectual property right relating to any combination, machine, or process in which TI products or services are used. Information regarding or referencing third-party products or services does not constitute a license to use such products or services, or a warranty or endorsement thereof. Use of TI Resources may require a license from a third party under the patents or other intellectual property of the third party, or a license from TI under the patents or other intellectual property of TI.

TI RESOURCES ARE PROVIDED "AS IS" AND WITH ALL FAULTS. TI DISCLAIMS ALL OTHER WARRANTIES OR REPRESENTATIONS, EXPRESS OR IMPLIED, REGARDING RESOURCES OR USE THEREOF, INCLUDING BUT NOT LIMITED TO ACCURACY OR COMPLETENESS, TITLE, ANY EPIDEMIC FAILURE WARRANTY AND ANY IMPLIED WARRANTIES OF MERCHANTABILITY, FITNESS FOR A PARTICULAR PURPOSE, AND NON-INFRINGEMENT OF ANY THIRD PARTY INTELLECTUAL PROPERTY RIGHTS. TI SHALL NOT BE LIABLE FOR AND SHALL NOT DEFEND OR INDEMNIFY DESIGNER AGAINST ANY CLAIM, INCLUDING BUT NOT LIMITED TO ANY INFRINGEMENT CLAIM THAT RELATES TO OR IS BASED ON ANY COMBINATION OF PRODUCTS EVEN IF DESCRIBED IN TI RESOURCES OR OTHERWISE. IN NO EVENT SHALL TI BE LIABLE FOR ANY ACTUAL, DIRECT, SPECIAL, COLLATERAL, INDIRECT, PUNITIVE, INCIDENTAL, CONSEQUENTIAL OR EXEMPLARY DAMAGES IN CONNECTION WITH OR ARISING OUT OF TI RESOURCES OR USE THEREOF, AND REGARDLESS OF WHETHER TI HAS BEEN ADVISED OF THE POSSIBILITY OF SUCH DAMAGES.

Unless TI has explicitly designated an individual product as meeting the requirements of a particular industry standard (e.g., ISO/TS 16949 and ISO 26262), TI is not responsible for any failure to meet such industry standard requirements.

Where TI specifically promotes products as facilitating functional safety or as compliant with industry functional safety standards, such products are intended to help enable customers to design and create their own applications that meet applicable functional safety standards and requirements. Using products in an application does not by itself establish any safety features in the application. Designers must ensure compliance with safety-related requirements and standards applicable to their applications. Designer may not use any TI products in life-critical medical equipment unless authorized officers of the parties have executed a special contract specifically governing such use. Life-critical medical equipment is medical equipment where failure of such equipment would cause serious bodily injury or death (e.g., life support, pacemakers, defibrillators, heart pumps, neurostimulators, and implantables). Such equipment includes, without limitation, all medical devices identified by the U.S. Food and Drug Administration as Class III devices and equivalent classifications outside the U.S.

TI may expressly designate certain products as completing a particular qualification (e.g., Q100, Military Grade, or Enhanced Product). Designers agree that it has the necessary expertise to select the product with the appropriate qualification designation for their applications and that proper product selection is at Designers' own risk. Designers are solely responsible for compliance with all legal and regulatory requirements in connection with such selection.

Designer will fully indemnify TI and its representatives against any damages, costs, losses, and/or liabilities arising out of Designer's non-compliance with the terms and provisions of this Notice.