

## REF19xx Low-Drift, Low-Power, Dual-Output, $V_{REF}$ and $V_{REF} / 2$ Voltage References

### 1 Features

- Two Outputs,  $V_{REF}$  and  $V_{REF} / 2$ , for Convenient Use in Single-Supply Systems
- Excellent Temperature Drift Performance:
  - 25 ppm/°C (max) from –40°C to 125°C
- High Initial Accuracy:  $\pm 0.1\%$  (max)
- $V_{REF}$  and  $V_{BIAS}$  Tracking over Temperature:
  - 6 ppm/°C (max) from –40°C to 85°C
  - 7 ppm/°C (max) from –40°C to 125°C
- Microsize Package: SOT23-5
- Low Dropout Voltage: 10 mV
- High Output Current:  $\pm 20$  mA
- Low Quiescent Current: 360  $\mu$ A
- Line Regulation: 3 ppm/V
- Load Regulation: 8 ppm/mA

### 2 Applications

- Digital Signal Processing:
  - Power Inverters
  - Motor Controls
- Current Sensing
- Industrial Process Controls
- Medical Equipment
- Data Acquisition Systems
- Single-Supply Systems

### 3 Description

Applications with only a positive supply voltage often require an additional stable voltage in the middle of the analog-to-digital converter (ADC) input range to bias input bipolar signals. The REF19xx provides a reference voltage ( $V_{REF}$ ) for the ADC and a second highly-accurate voltage ( $V_{BIAS}$ ) that can be used to bias the input bipolar signals.

The REF19xx offers excellent temperature drift (25 ppm/°C, max) and initial accuracy (0.1%) on both the  $V_{REF}$  and  $V_{BIAS}$  outputs while operating at a quiescent current less than 430  $\mu$ A. In addition, the  $V_{REF}$  and  $V_{BIAS}$  outputs track each other with a precision of 6 ppm/°C (max) across the temperature range of –40°C to 85°C. All these features increase the precision of the signal chain and decrease board space, while reducing the cost of the system as compared to a discrete solution. Extremely low dropout voltage of only 10 mV allows operation from very low input voltages, which can be very useful in battery-operated systems.

Both the  $V_{REF}$  and  $V_{BIAS}$  voltages have the same excellent specifications and can sink and source current equally well. Very good long-term stability and low noise levels make these devices ideally-suited for high-precision industrial applications.

#### Device Information<sup>(1)</sup>

PART NAME	PACKAGE	BODY SIZE (NOM)
REF19xx	SOT (5)	2.90 mm x 1.60 mm

(1) For all available packages, see the orderable addendum at the end of the datasheet.

Application Example

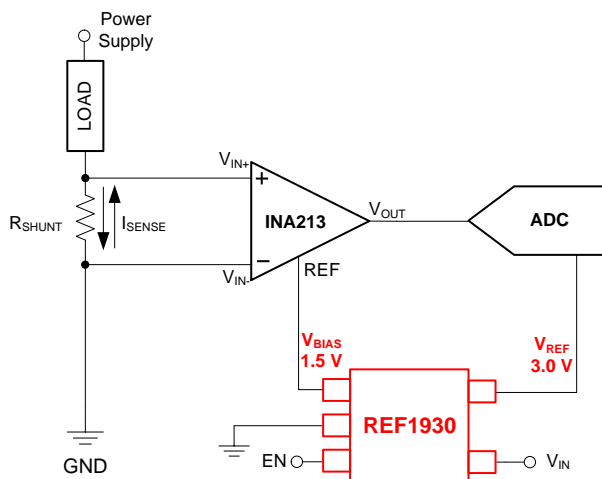

$V_{REF}$  and  $V_{BIAS}$  vs Temperature

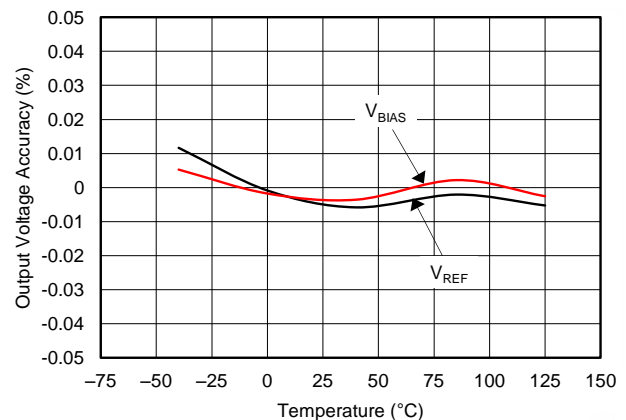

## Table of Contents

<b>1 Features</b> .....	<b>1</b>	9.1 Overview .....	<b>15</b>
<b>2 Applications</b> .....	<b>1</b>	9.2 Functional Block Diagram .....	<b>15</b>
<b>3 Description</b> .....	<b>1</b>	9.3 Feature Description .....	<b>15</b>
<b>4 Revision History</b> .....	<b>2</b>	9.4 Device Functional Modes .....	<b>16</b>
<b>5 Device Comparison Table</b> .....	<b>3</b>	<b>10 Applications and Implementation</b> .....	<b>17</b>
<b>6 Pin Configuration and Functions</b> .....	<b>3</b>	10.1 Application Information .....	<b>17</b>
<b>7 Specifications</b> .....	<b>4</b>	10.2 Typical Application .....	<b>17</b>
7.1 Absolute Maximum Ratings .....	<b>4</b>	<b>11 Power-Supply Recommendations</b> .....	<b>22</b>
7.2 Handling Ratings .....	<b>4</b>	<b>12 Layout</b> .....	<b>23</b>
7.3 Recommended Operating Conditions .....	<b>4</b>	12.1 Layout Guidelines .....	<b>23</b>
7.4 Thermal Information .....	<b>4</b>	12.2 Layout Example .....	<b>23</b>
7.5 Electrical Characteristics .....	<b>5</b>	<b>13 Device and Documentation Support</b> .....	<b>24</b>
7.6 Typical Characteristics .....	<b>6</b>	13.1 Documentation Support .....	<b>24</b>
<b>8 Parameter Measurement Information</b> .....	<b>12</b>	13.2 Related Links .....	<b>24</b>
8.1 Solder Heat Shift .....	<b>12</b>	13.3 Trademarks .....	<b>24</b>
8.2 Thermal Hysteresis .....	<b>13</b>	13.4 Electrostatic Discharge Caution .....	<b>24</b>
8.3 Noise Performance .....	<b>14</b>	13.5 Glossary .....	<b>24</b>
<b>9 Detailed Description</b> .....	<b>15</b>	<b>14 Mechanical, Packaging, and Orderable Information</b> .....	<b>24</b>

## 4 Revision History

DATE	REVISION	NOTES
September 2014	*	Initial release.

## 5 Device Comparison Table

PRODUCT	$V_{REF}$	$V_{BIAS}$
REF1925	2.5 V	1.25 V
REF1930	3.0 V	1.5 V
REF1933	3.3 V	1.65 V
REF1941	4.096 V	2.048 V

## 6 Pin Configuration and Functions

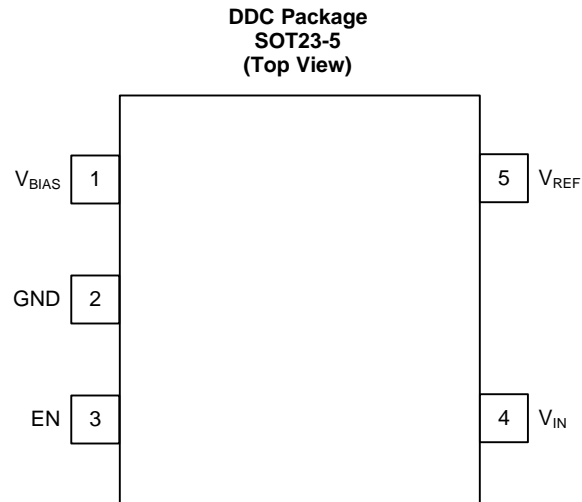

### Pin Functions

PIN		I/O	DESCRIPTION
NO.	NAME		
1	$V_{BIAS}$	Input	Bias voltage output ( $V_{REF} / 2$ )
2	GND	—	Ground
3	EN	Input	Enable ( $EN \geq V_{IN} - 0.7\text{ V}$ , device enabled)
4	$V_{IN}$	Input	Input supply voltage
5	$V_{REF}$	Output	Reference voltage output ( $V_{REF}$ )

## 7 Specifications

### 7.1 Absolute Maximum Ratings

over operating free-air temperature range (unless otherwise noted)<sup>(1)</sup>

		MIN	MAX	UNIT
Input voltage	V <sub>IN</sub>	-0.3	6	V
	EN	-0.3	V <sub>IN</sub> + 0.3	V
Temperature	Operating temperature range	-55	150	°C
	Junction Temperature, T <sub>J</sub>		150	°C

- (1) Stresses beyond those listed under *Absolute Maximum Ratings* may cause permanent damage to the device. These are stress ratings only, which do not imply functional operation of the device at these or any other conditions beyond those indicated under *Recommended Operating Conditions*. Exposure to absolute-maximum-rated conditions for extended periods may affect device reliability.

### 7.2 Handling Ratings

			MIN	MAX	UNIT
T <sub>stg</sub>	Storage temperature range		-65	170	°C
V <sub>(ESD)</sub>	Electrostatic discharge	Human body model (HBM), per ANSI/ESDA/JEDEC JS-001, all pins <sup>(1)</sup>	-4000	4000	V
		Charged device model (CDM), per JEDEC specification JESD22-C101, all pins <sup>(2)</sup>	-1500	1500	

- (1) JEDEC document JEP155 states that 500-V HBM allows safe manufacturing with a standard ESD control process.  
 (2) JEDEC document JEP157 states that 250-V CDM allows safe manufacturing with a standard ESD control process.

### 7.3 Recommended Operating Conditions

over operating free-air temperature range (unless otherwise noted)

		MIN	NOM	MAX	UNIT
V <sub>IN</sub>	Supply input voltage range (I <sub>L</sub> = 0 mA, T <sub>A</sub> = 25°C)	V <sub>REF</sub> + 0.02 <sup>(1)</sup>		5.5	V

- (1) Refer to [Figure 24](#) in the *Typical Characteristics* section for the minimum input voltage at different load currents and temperature.

### 7.4 Thermal Information

THERMAL METRIC <sup>(1)</sup>		REF19xx	UNIT
		DDC (SOT23)	
		5 PINS	
R <sub>θJA</sub>	Junction-to-ambient thermal resistance	193.6	°C/W
R <sub>θJC(top)</sub>	Junction-to-case (top) thermal resistance	40.2	
R <sub>θJB</sub>	Junction-to-board thermal resistance	34.5	
Ψ <sub>JT</sub>	Junction-to-top characterization parameter	0.9	
Ψ <sub>JB</sub>	Junction-to-board characterization parameter	34.3	
R <sub>θJC(bot)</sub>	Junction-to-case (bottom) thermal resistance	N/A	

- (1) For more information about traditional and new thermal metrics, see the *IC Package Thermal Metrics* application report, [SPRA953](#).

## 7.5 Electrical Characteristics

At  $T_A = 25^\circ\text{C}$ ,  $I_L = 0\text{ mA}$ , and  $V_{IN} = 5\text{ V}$ , unless otherwise noted. Both  $V_{REF}$  and  $V_{BIAS}$  have the same specifications.

PARAMETER		TEST CONDITIONS	MIN	TYP	MAX	UNIT
<b>ACCURACY AND DRIFT</b>						
Output voltage accuracy			-0.1%		0.1%	
Output voltage temperature coefficient <sup>(1)</sup>		$-40^\circ\text{C} \leq T_A \leq 125^\circ\text{C}$		$\pm 10$	$\pm 25$	ppm/ $^\circ\text{C}$
$V_{REF}$ and $V_{BIAS}$ tracking over temperature <sup>(2)</sup>		$-40^\circ\text{C} \leq T_A \leq 85^\circ\text{C}$		$\pm 1.5$	$\pm 6$	ppm/ $^\circ\text{C}$
		$-40^\circ\text{C} \leq T_A \leq 125^\circ\text{C}$		$\pm 2$	$\pm 7$	ppm/ $^\circ\text{C}$
<b>LINE AND LOAD REGULATION</b>						
$\Delta V_{O(\Delta V)}$	Line regulation	$V_{REF} + 0.02\text{ V} \leq V_{IN} \leq 5.5\text{ V}$		3	35	ppm/V
$\Delta V_{O(\Delta I)}$	Load regulation	Sourcing $0\text{ mA} \leq I_L \leq 20\text{ mA}$ , $V_{REF} + 0.6\text{ V} \leq V_{IN} \leq 5.5\text{ V}$		8	20	ppm/mA
		Sinking $0\text{ mA} \leq I_L \leq -20\text{ mA}$ , $V_{REF} + 0.02\text{ V} \leq V_{IN} \leq 5.5\text{ V}$		8	20	ppm/mA
<b>POWER SUPPLY</b>						
$I_{CC}$	Supply current	Active mode $-40^\circ\text{C} \leq T_A \leq 125^\circ\text{C}$		360	430	$\mu\text{A}$
					460	$\mu\text{A}$
	Enable voltage	Device in shutdown mode (EN = 0) Device in active mode (EN = 1)		0	0.7	V
				$V_{IN} - 0.7$	$V_{IN}$	V
	Dropout voltage	$I_L = 20\text{ mA}$		10	20	mV
					600	mV
$I_{SC}$	Short-circuit current			50		mA
$t_{on}$	Turn-on time	0.1% settling, $C_L = 1\text{ }\mu\text{F}$		500		$\mu\text{s}$
<b>NOISE</b>						
	Low-frequency noise <sup>(3)</sup>	$0.1\text{ Hz} \leq f \leq 10\text{ Hz}$		12		ppm <sub>PP</sub>
	Output voltage noise density	$f = 100\text{ Hz}$		0.25		ppm/ $\sqrt{\text{Hz}}$
<b>CAPACITIVE LOAD</b>						
	Stable output capacitor range			0	10	$\mu\text{F}$
<b>HYSTERESIS AND LONG-TERM STABILITY</b>						
	Long-term stability	0 to 1000 hours		60		ppm
	Output voltage hysteresis <sup>(4)</sup>	$25^\circ\text{C}$ , $-40^\circ\text{C}$ , $125^\circ\text{C}$ , $25^\circ\text{C}$	Cycle 1	60		ppm
			Cycle 2	35		ppm

(1) Temperature drift is specified according to the box method. See the [Feature Description](#) section for more details.

(2) The  $V_{REF}$  and  $V_{BIAS}$  tracking over temperature specification is explained in more detail in the [Feature Description](#) section.

(3) The peak-to-peak noise measurement procedure is explained in more detail in the [Noise Performance](#) section.

(4) The thermal hysteresis measurement procedure is explained in more detail in the [Thermal Hysteresis](#) section.

## 7.6 Typical Characteristics

At  $T_A = 25^\circ\text{C}$ ,  $I_L = 0\text{ mA}$ ,  $V_{IN} = 5\text{-V}$  power supply,  $C_L = 0\text{ }\mu\text{F}$ , and  $2.5\text{-V}$  output, unless otherwise noted.

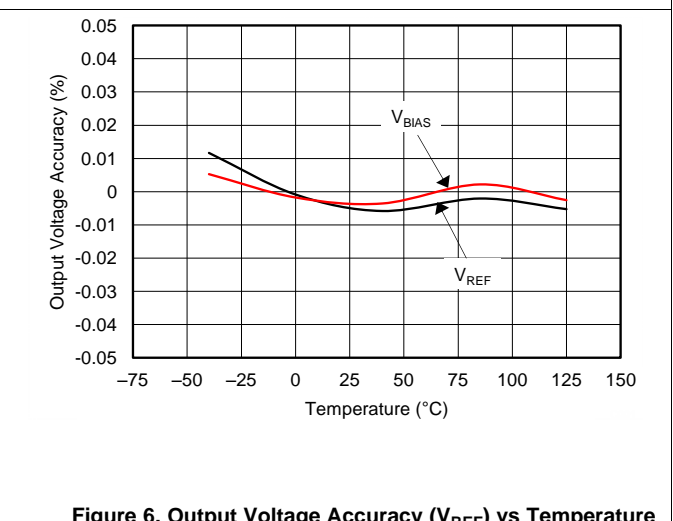
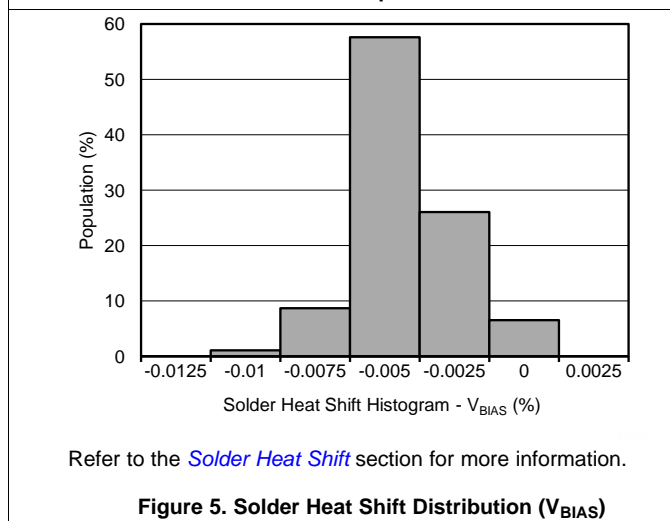
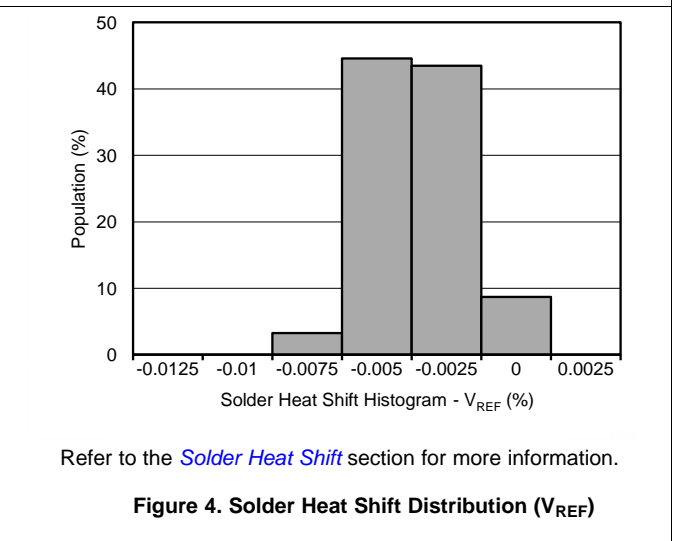
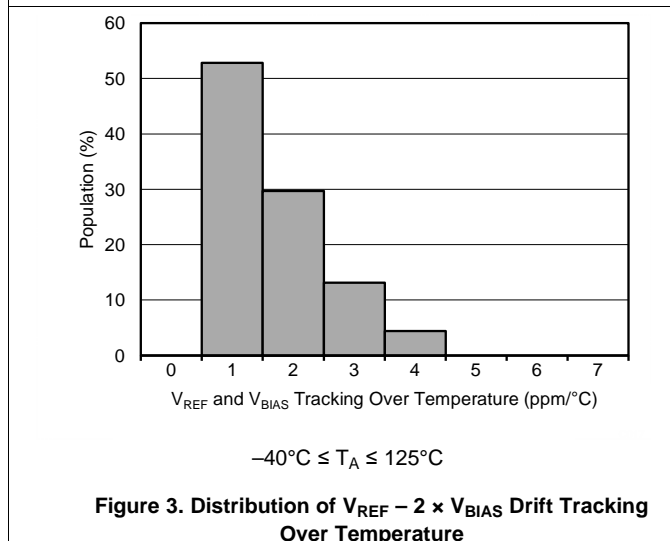
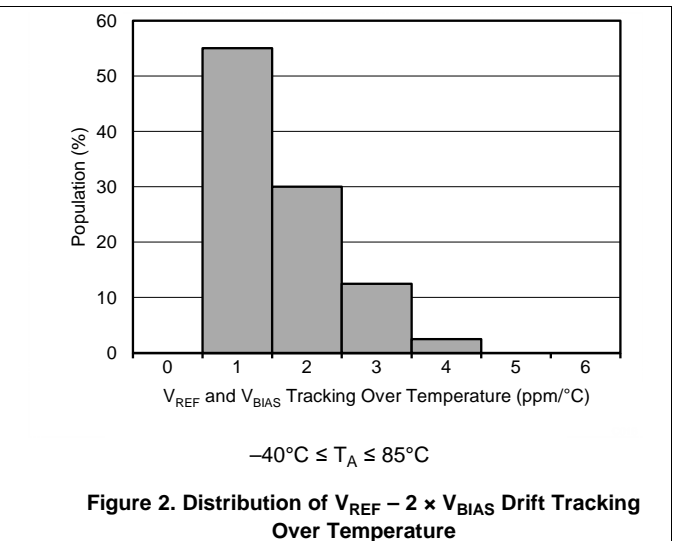
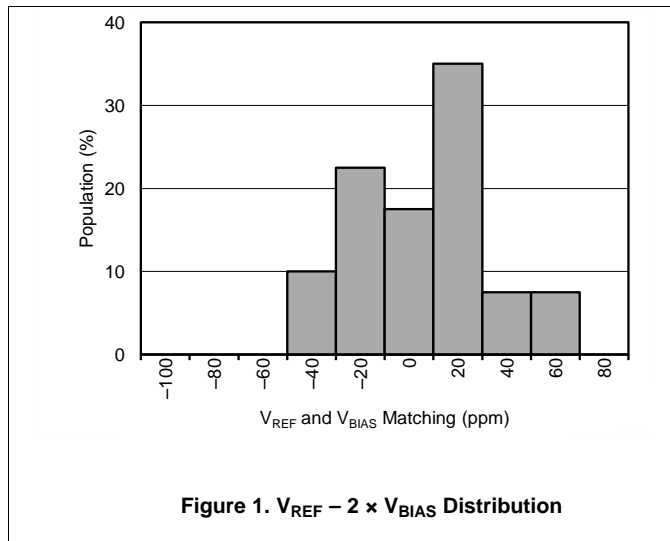

Typical Characteristics (continued)

At  $T_A = 25^\circ\text{C}$ ,  $I_L = 0\text{ mA}$ ,  $V_{IN} = 5\text{-V}$  power supply,  $C_L = 0\text{ }\mu\text{F}$ , and  $2.5\text{-V}$  output, unless otherwise noted.

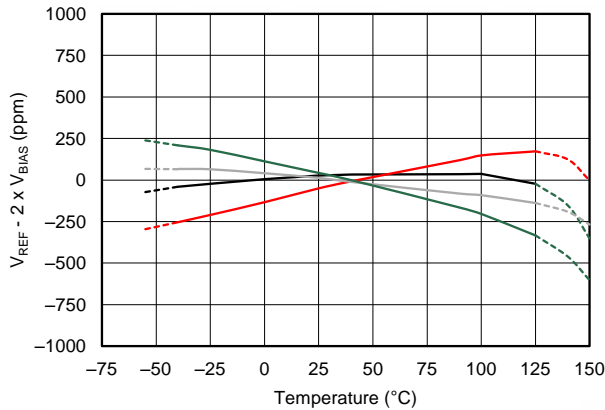

Figure 7.  $V_{REF} - 2 \times V_{BIAS}$  Tracking vs Temperature

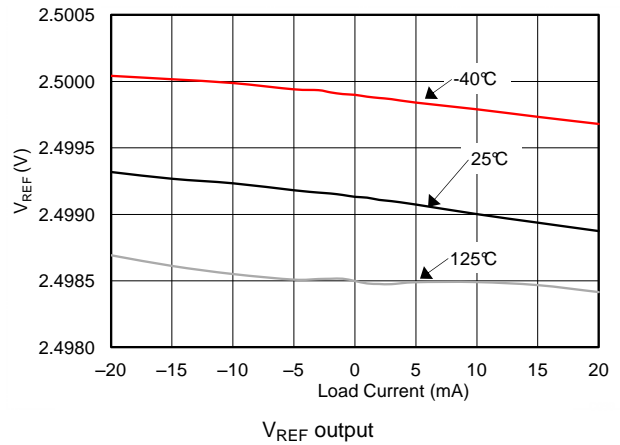

Figure 8. Output Voltage Change vs Load Current ( $V_{REF}$ )

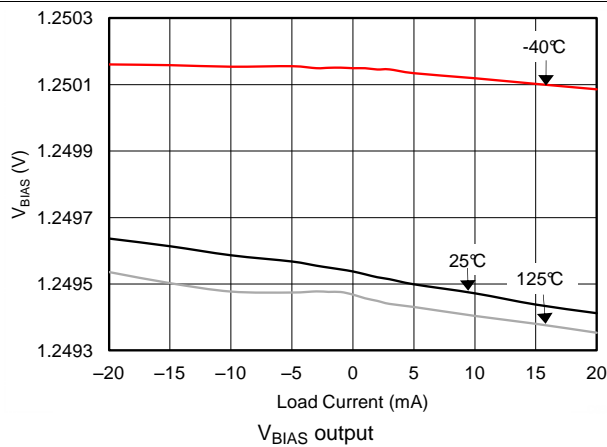

Figure 9. Output Voltage Change vs Load Current ( $V_{BIAS}$ )

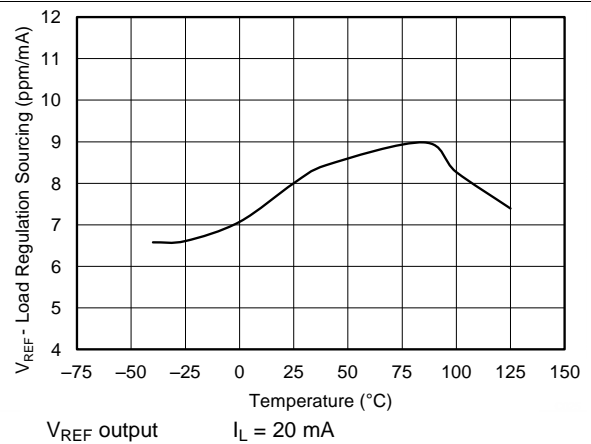

Figure 10. Load Regulation Sourcing vs Temperature ( $V_{REF}$ )

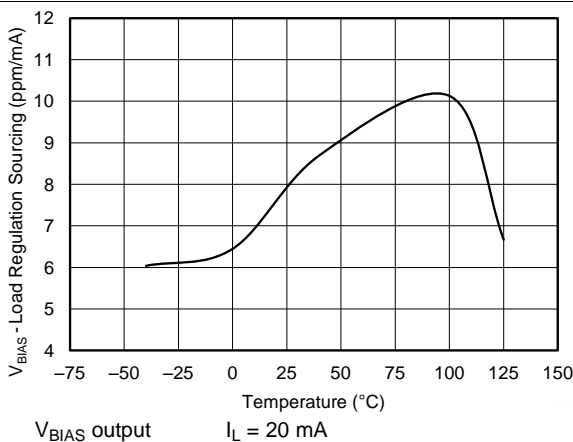

Figure 11. Load Regulation Sourcing vs Temperature ( $V_{BIAS}$ )

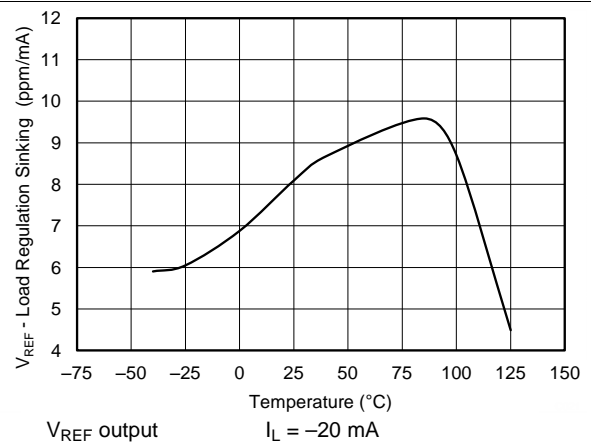

Figure 12. Load Regulation Sinking vs Temperature ( $V_{REF}$ )

### Typical Characteristics (continued)

At  $T_A = 25^\circ\text{C}$ ,  $I_L = 0\text{ mA}$ ,  $V_{IN} = 5\text{-V}$  power supply,  $C_L = 0\text{ }\mu\text{F}$ , and 2.5-V output, unless otherwise noted.

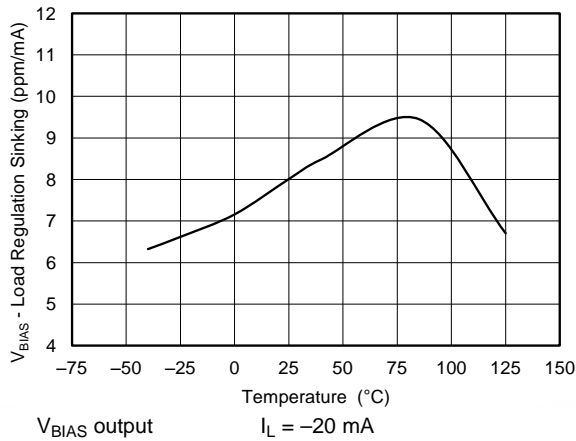

Figure 13. Load Regulation Sinking vs Temperature ( $V_{BIAS}$ )

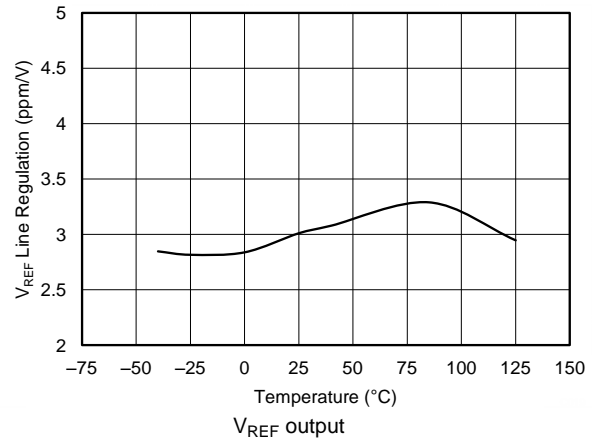

Figure 14. Line Regulation vs Temperature ( $V_{REF}$ )

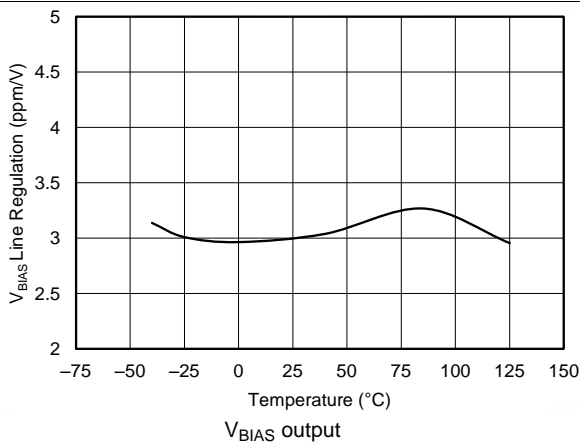

Figure 15. Line Regulation vs Temperature ( $V_{BIAS}$ )

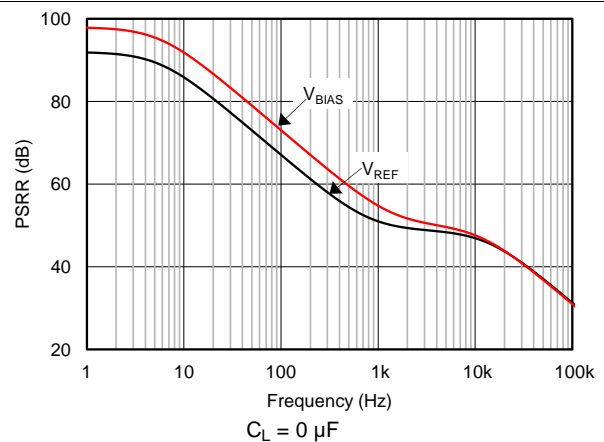

Figure 16. Power-Supply Rejection Ratio vs Frequency

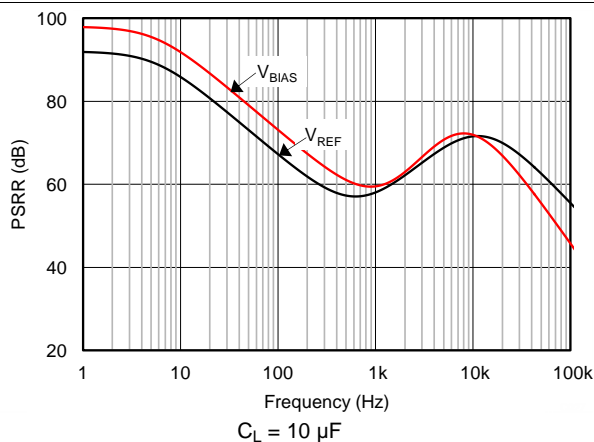

Figure 17. Power-Supply Rejection Ratio vs Frequency

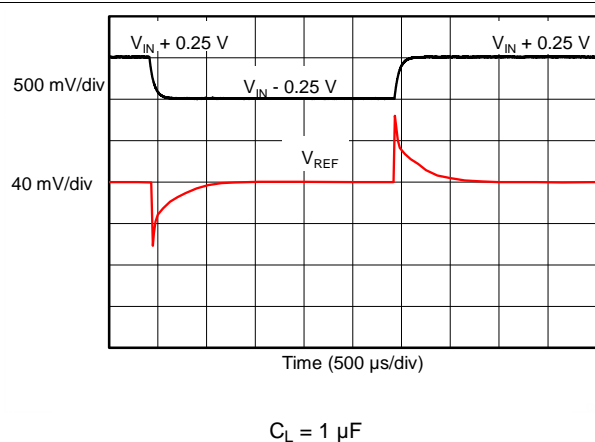
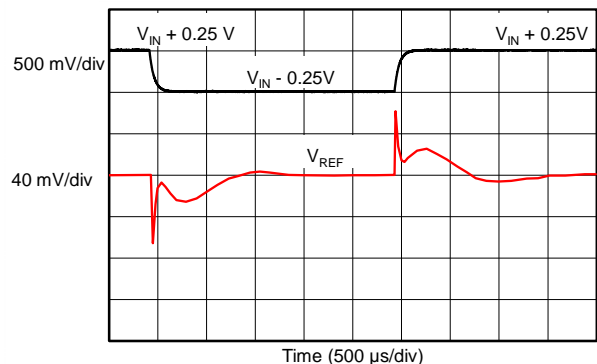

Figure 18. Line Transient Response



Typical Characteristics (continued)

At  $T_A = 25^\circ\text{C}$ ,  $I_L = 0\text{ mA}$ ,  $V_{IN} = 5\text{-V power supply}$ ,  $C_L = 0\text{ }\mu\text{F}$ , and  $2.5\text{-V output}$ , unless otherwise noted.



$C_L = 10\text{ }\mu\text{F}$

Figure 19. Line Transient Response

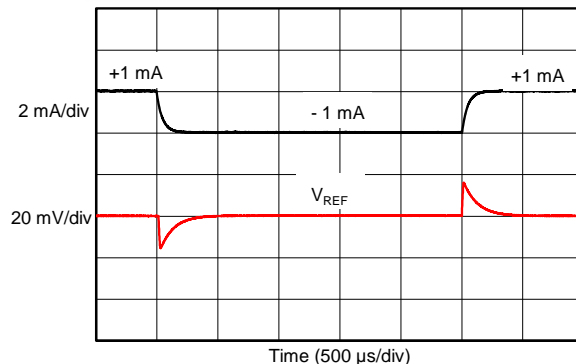

$C_L = 1\text{ }\mu\text{F}$   $I_L = \pm 1\text{-mA step}$

Figure 20. Load Transient Response

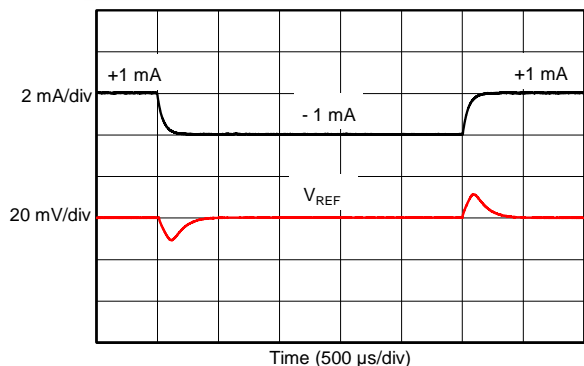

$C_L = 10\text{ }\mu\text{F}$   $I_L = \pm 1\text{-mA step}$

Figure 21. Load Transient Response

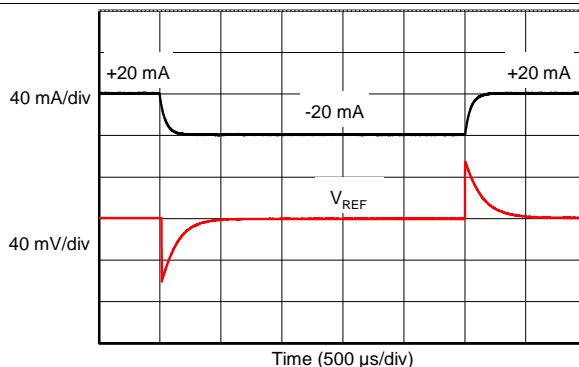

$C_L = 1\text{ }\mu\text{F}$   $I_L = \pm 20\text{-mA step}$

Figure 22. Load Transient Response

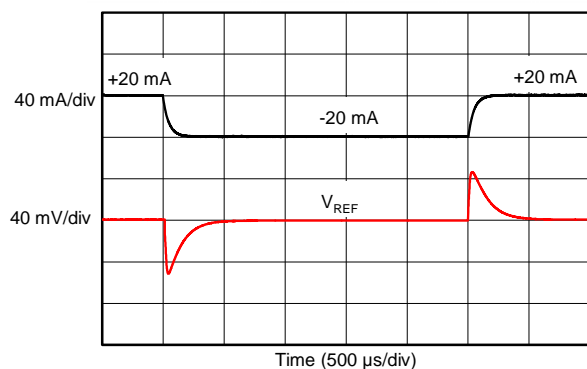

$C_L = 10\text{ }\mu\text{F}$   $I_L = \pm 20\text{-mA step}$

Figure 23. Load Transient Response

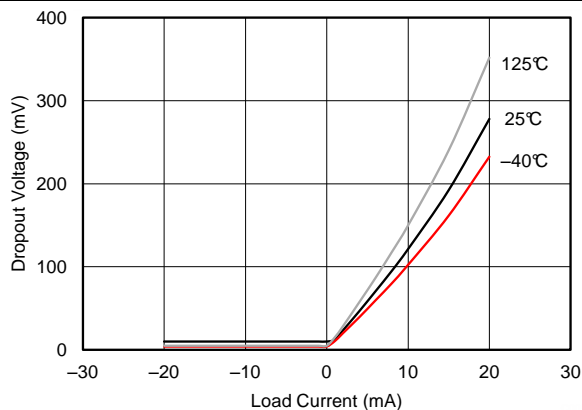
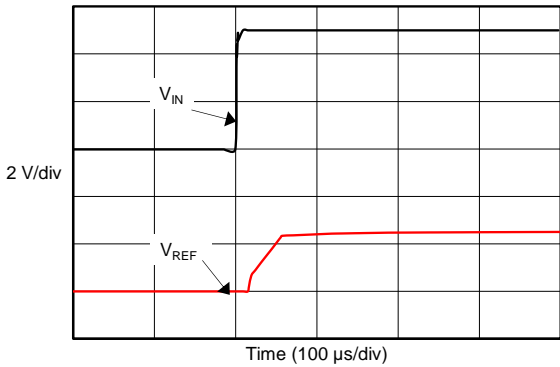

Figure 24. Minimum Dropout Voltage vs Load Current

Typical Characteristics (continued)

At  $T_A = 25^\circ\text{C}$ ,  $I_L = 0\text{ mA}$ ,  $V_{IN} = 5\text{-V}$  power supply,  $C_L = 0\text{ }\mu\text{F}$ , and 2.5-V output, unless otherwise noted.



$C_L = 1\text{ }\mu\text{F}$

Figure 25. Turn-On Settling Time

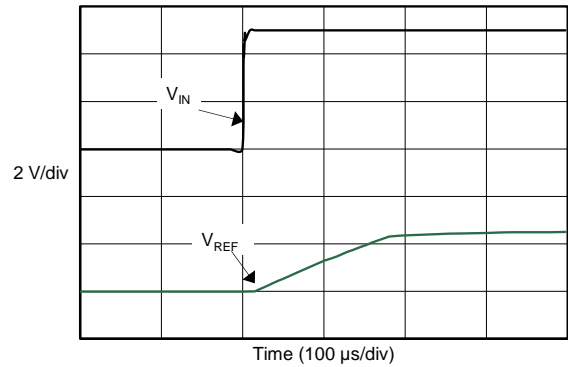

$C_L = 10\text{ }\mu\text{F}$

Figure 26. Turn-On Settling Time

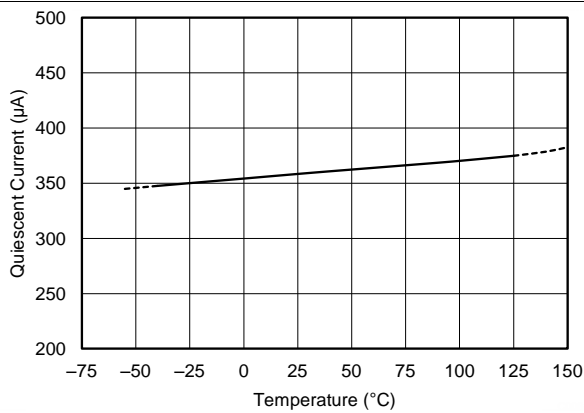

Figure 27. Quiescent Current vs Temperature

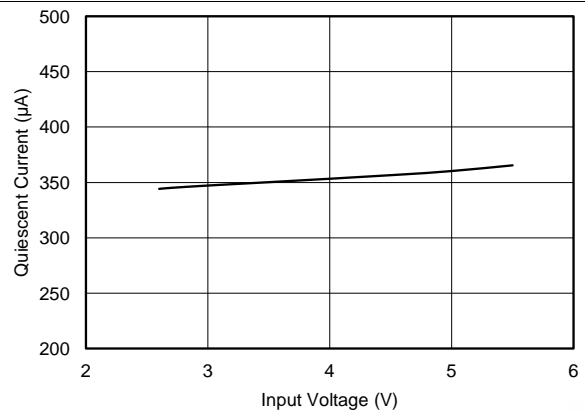
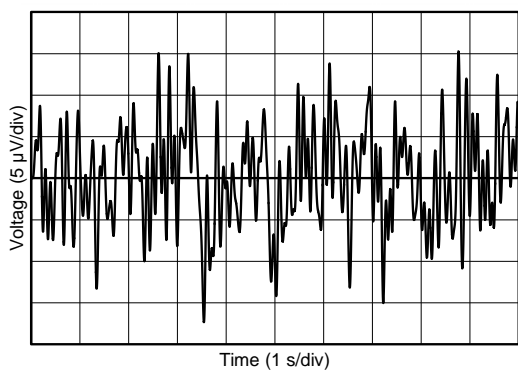
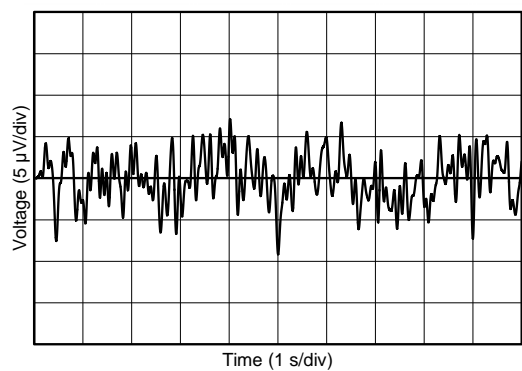

Figure 28. Quiescent Current vs Input Voltage



$V_{REF}$  output

Figure 29. 0.1-Hz to 10-Hz Noise ( $V_{REF}$ )



$V_{BIAS}$  output

Figure 30. 0.1-Hz to 10-Hz Noise ( $V_{BIAS}$ )

Typical Characteristics (continued)

At  $T_A = 25^\circ\text{C}$ ,  $I_L = 0\text{ mA}$ ,  $V_{IN} = 5\text{-V}$  power supply,  $C_L = 0\ \mu\text{F}$ , and 2.5-V output, unless otherwise noted.

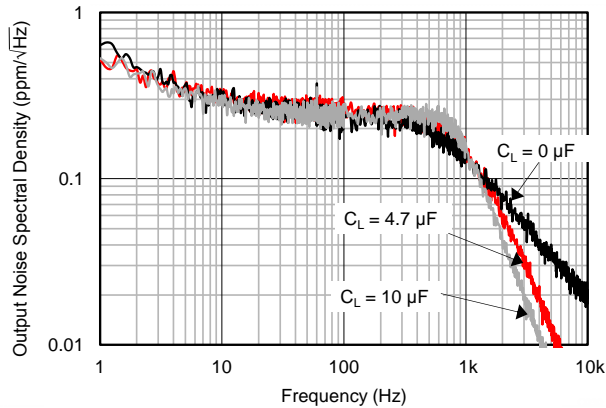

Figure 31. Output Voltage Noise Spectrum

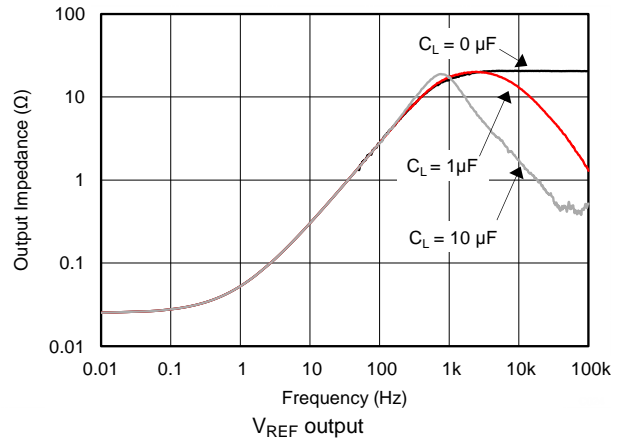

Figure 32. Output Impedance vs Frequency ( $V_{REF}$ )

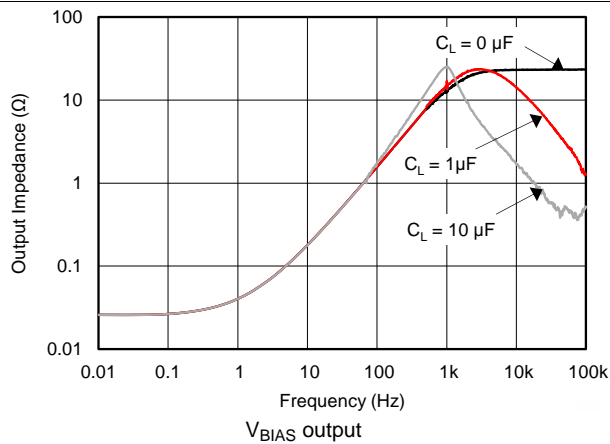

Figure 33. Output Impedance vs Frequency ( $V_{BIAS}$ )

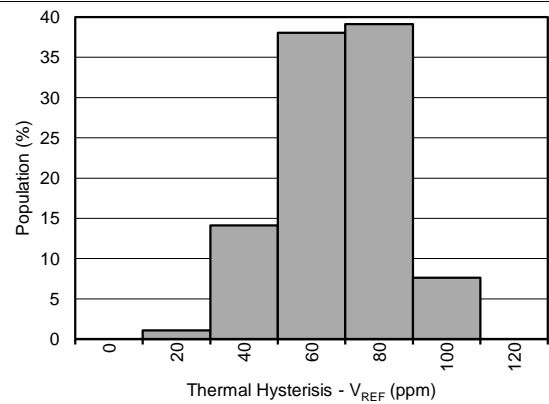

Figure 34. Thermal Hysteresis Distribution ( $V_{REF}$ )

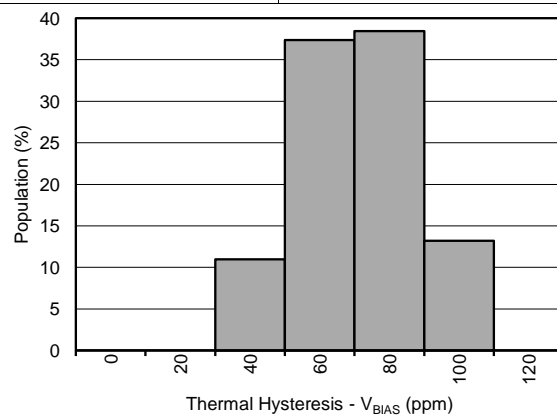

Figure 35. Thermal Hysteresis Distribution ( $V_{BIAS}$ )

## 8 Parameter Measurement Information

### 8.1 Solder Heat Shift

The materials used in the manufacture of the REF19xx have differing coefficients of thermal expansion, resulting in stress on the device die when the device is heated. Mechanical and thermal stress on the device die can cause the output voltages to shift, degrading the initial accuracy specifications of the product. Reflow soldering is a common cause of this error.

In order to illustrate this effect, a total of 92 devices were soldered on four printed circuit boards [23 devices on each printed circuit board (PCB)] using lead-free solder paste and the paste manufacturer suggested reflow profile. The reflow profile is as shown in [Figure 36](#). The PCB is comprised of FR4 material. The board thickness is 1.57 mm and the area is 171.54 mm × 165.1 mm.

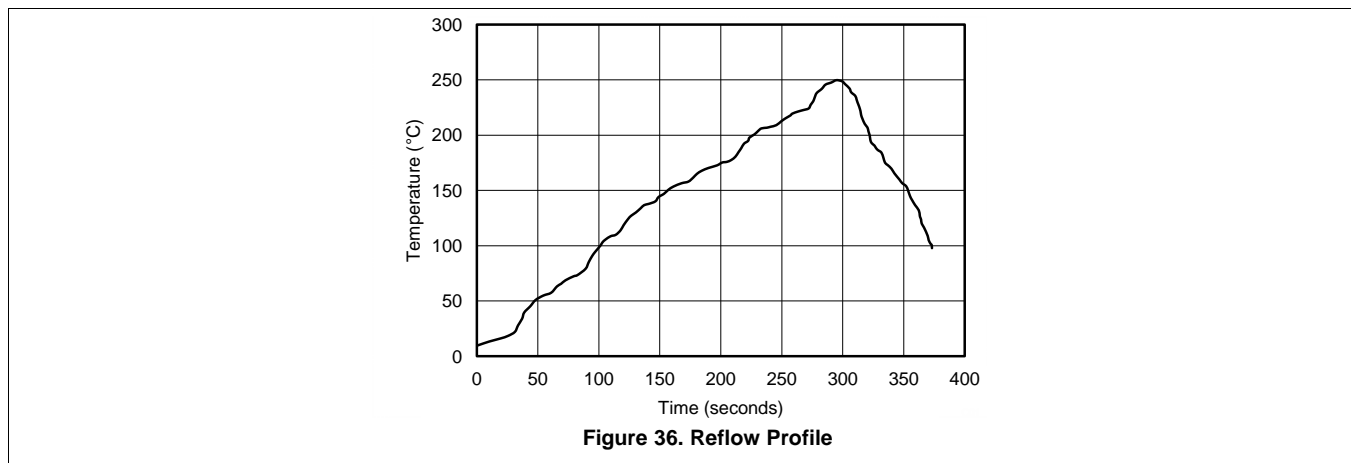

The reference and bias output voltages are measured before and after the reflow process; the typical shift is displayed in [Figure 37](#) and [Figure 38](#). Although all tested units exhibit very low shifts (< 0.01%), higher shifts are also possible depending on the size, thickness, and material of the PCB. An important note is that the histograms display the typical shift for exposure to a single reflow profile. Exposure to multiple reflows, which is common on PCBs with surface-mount components on both sides, causes additional shifts in the output bias voltage. If the PCB is exposed to multiple reflows, solder the device in the second pass to minimize device exposure to thermal stress.

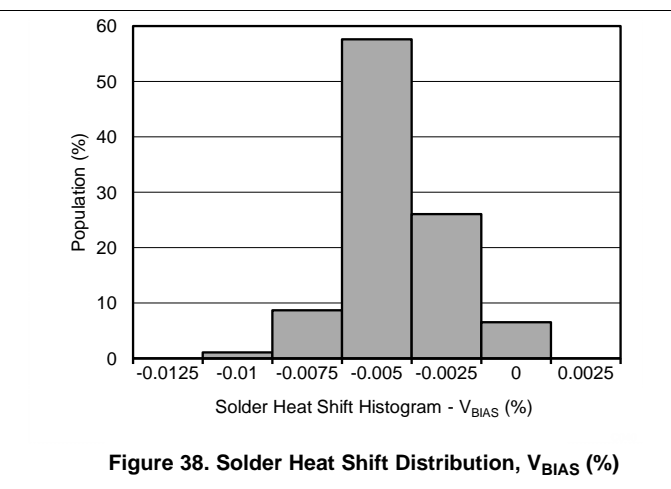
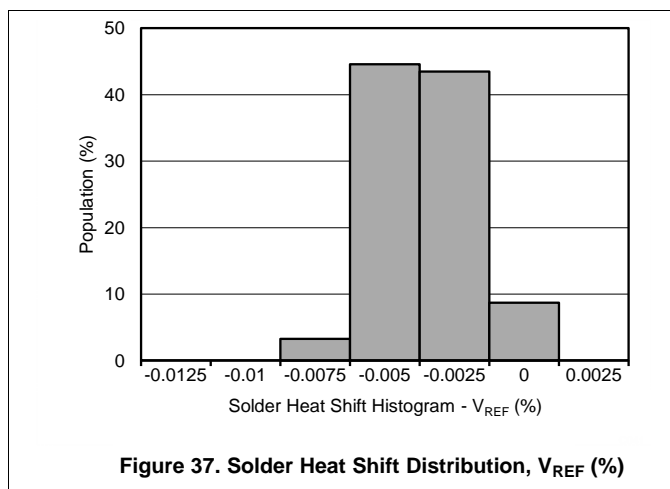

## 8.2 Thermal Hysteresis

Thermal hysteresis is measured with the REF19xx soldered to a PCB, similar to a real-world application. Thermal hysteresis for the device is defined as the change in output voltage after operating the device at 25°C, cycling the device through the specified temperature range, and returning to 25°C. Hysteresis can be expressed by Equation 1:

$$V_{\text{HYST}} = \left( \frac{|V_{\text{PRE}} - V_{\text{POST}}|}{V_{\text{NOM}}} \right) \cdot 10^6 \text{ (ppm)}$$

where

- $V_{\text{HYST}}$  = thermal hysteresis (in units of ppm),
  - $V_{\text{NOM}}$  = the specified output voltage,
  - $V_{\text{PRE}}$  = output voltage measured at 25°C pre-temperature cycling, and
  - $V_{\text{POST}}$  = output voltage measured after the device has cycled from 25°C through the specified temperature range of –40°C to 125°C and returns to 25°C.
- (1)

Typical thermal hysteresis distribution is as shown in Figure 39 and Figure 40.

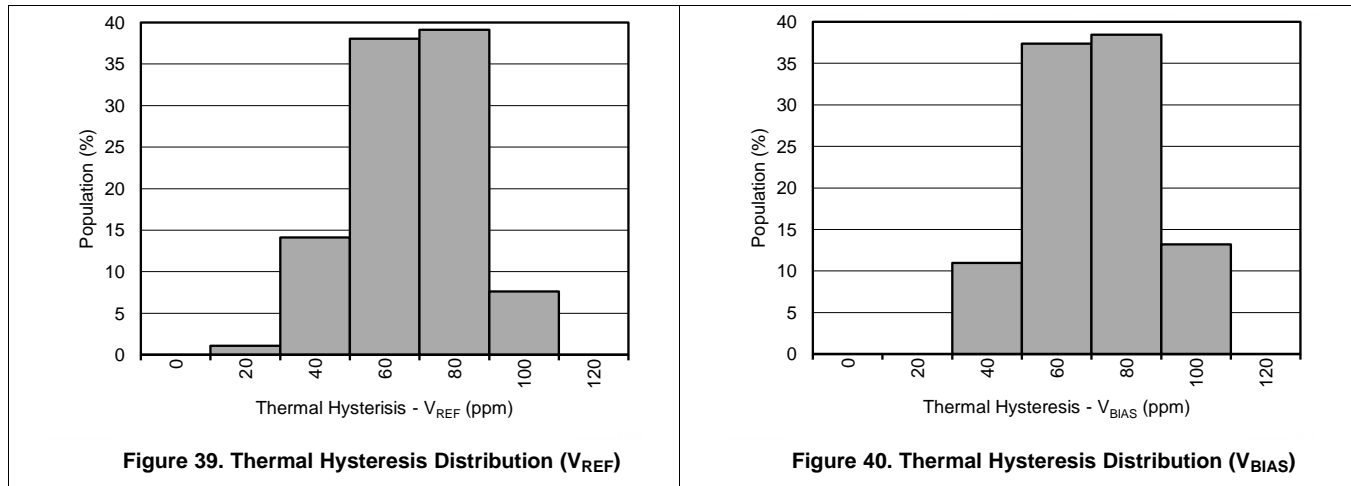

### 8.3 Noise Performance

Typical 0.1-Hz to 10-Hz voltage noise is shown in [Figure 41](#) and [Figure 42](#). Device noise increases with output voltage and operating temperature. Additional filtering can be used to improve output noise levels, although care must be taken to ensure the output impedance does not degrade ac performance. Peak-to-peak noise measurement setup is shown in [Figure 43](#).

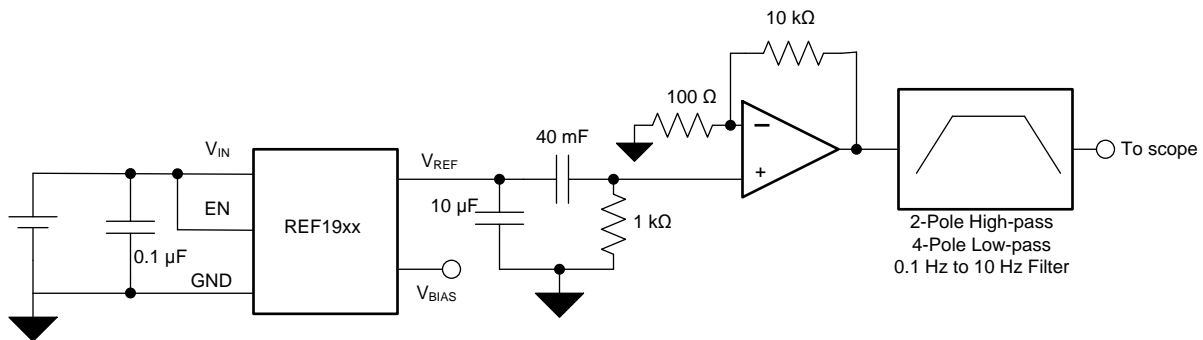
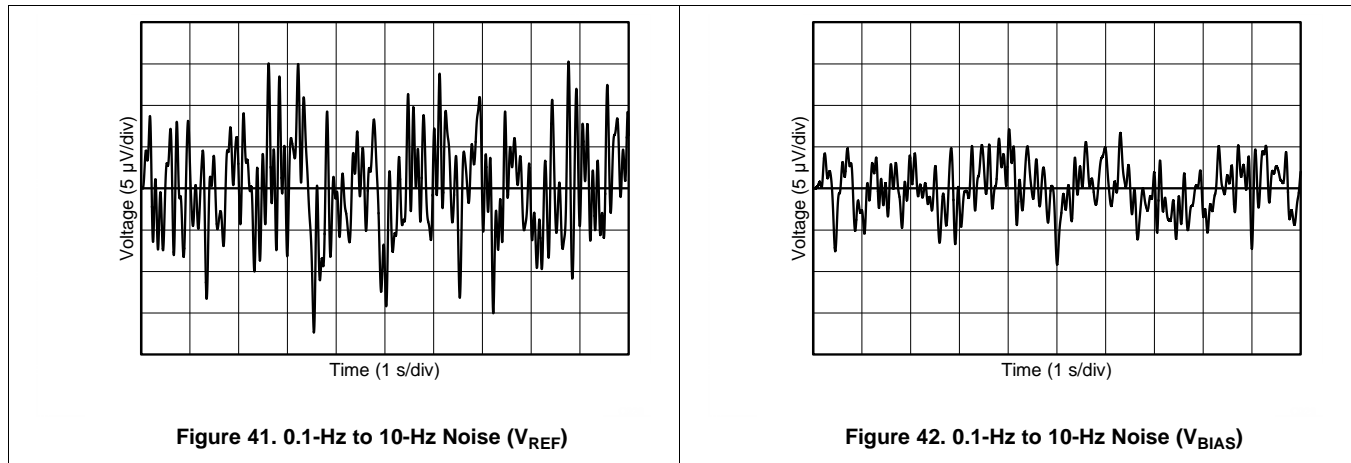

Figure 43. 0.1-Hz to 10-Hz Noise Measurement Setup

## 9 Detailed Description

### 9.1 Overview

The REF19xx is a family of dual-output,  $V_{REF}$  and  $V_{BIAS}$  ( $V_{REF} / 2$ ) band-gap voltage references. The [Functional Block Diagram](#) section provides a block diagram of the basic band-gap topology and the two buffers used to derive the  $V_{REF}$  and  $V_{BIAS}$  outputs. Transistors  $Q_1$  and  $Q_2$  are biased such that the current density of  $Q_1$  is greater than that of  $Q_2$ . The difference of the two base emitter voltages ( $V_{BE1} - V_{BE2}$ ) has a positive temperature coefficient and is forced across resistor  $R_5$ . The voltage is amplified and added to the base emitter voltage of  $Q_2$ , which has a negative temperature coefficient. The resulting band-gap output voltage is almost independent of temperature. Two independent buffers are used to generate  $V_{REF}$  and  $V_{BIAS}$  from the band-gap voltage. The resistors  $R_1$ ,  $R_2$  and  $R_3$ ,  $R_4$  are sized such that  $V_{BIAS} = V_{REF} / 2$ .

e-Trim™ is a method of package-level trim for the initial accuracy and temperature coefficient of  $V_{REF}$  and  $V_{BIAS}$ , implemented during the final steps of manufacturing after the plastic molding process. This method minimizes the influence of inherent transistor mismatch, as well as errors induced during package molding. e-Trim is implemented in the REF19xx to minimize the temperature drift and maximize the initial accuracy of both the  $V_{REF}$  and  $V_{BIAS}$  outputs.

### 9.2 Functional Block Diagram

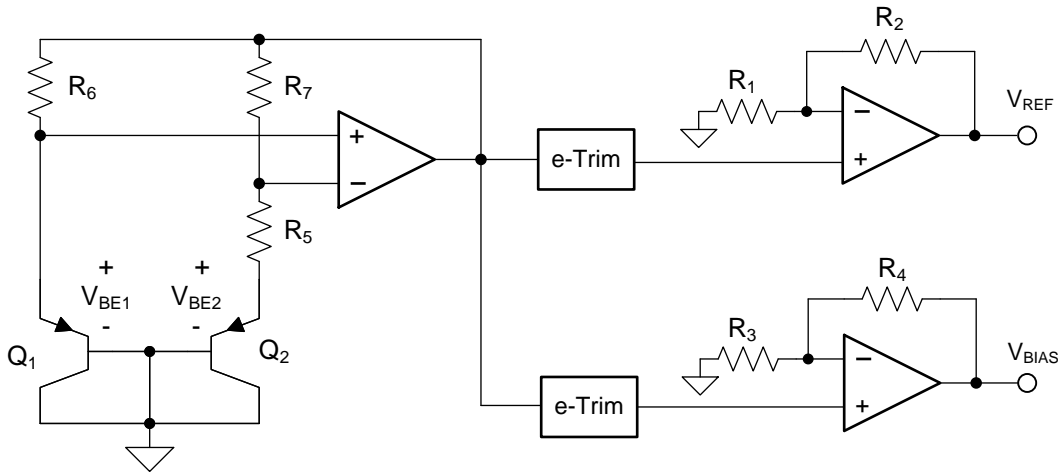

### 9.3 Feature Description

#### 9.3.1 $V_{REF}$ and $V_{BIAS}$ Tracking

Most single-supply systems require an additional stable voltage in the middle of the analog-to-digital converter (ADC) input range to bias input bipolar signals. The  $V_{REF}$  and  $V_{BIAS}$  outputs of the REF19xx are generated from the same band-gap voltage as shown in the [Functional Block Diagram](#) section. Hence, both outputs track each other over the full temperature range of  $-40^{\circ}\text{C}$  to  $125^{\circ}\text{C}$  with an accuracy of 7 ppm/ $^{\circ}\text{C}$  (max). The tracking accuracy increases to 6 ppm/ $^{\circ}\text{C}$  (max) when the temperature range is limited to  $-40^{\circ}\text{C}$  to  $85^{\circ}\text{C}$ . The tracking error is calculated using the box method, as described by [Equation 2](#):

$$\text{Tracking Error} = \left( \frac{V_{\text{DIFF(MAX)}} - V_{\text{DIFF(MIN)}}}{V_{\text{REF}} \cdot \text{Temperature Range}} \right) \cdot 10^6 \quad (\text{ppm})$$

where

$$\bullet \quad V_{\text{DIFF}} = V_{\text{REF}} - 2 \cdot V_{\text{BIAS}} \quad (2)$$

## Feature Description (continued)

The tracking accuracy is as shown in [Figure 44](#).

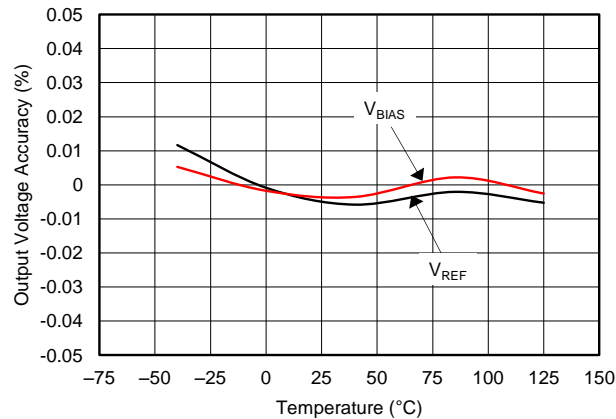

**Figure 44. V<sub>REF</sub> and V<sub>BIAS</sub> Tracking vs Temperature**

### 9.3.2 Low Temperature Drift

The REF19xx is designed for minimal drift error, which is defined as the change in output voltage over temperature. The drift is calculated using the box method, as described by [Equation 3](#):

$$\text{Drift} = \left( \frac{V_{\text{REF(MAX)}} - V_{\text{REF(MIN)}}}{V_{\text{REF}} \cdot \text{Temperature Range}} \right) \cdot 10^6 \quad (\text{ppm}) \quad (3)$$

### 9.3.3 Load Current

The REF19xx family is specified to deliver a current load of  $\pm 20$  mA per output. Both the V<sub>REF</sub> and V<sub>BIAS</sub> outputs of the device are protected from short circuits by limiting the output short-circuit current to 50 mA. The device temperature increases according to [Equation 4](#):

$$T_J = T_A + P_D \cdot R_{\theta JA}$$

where

- T<sub>J</sub> = junction temperature (°C),
- T<sub>A</sub> = ambient temperature (°C),
- P<sub>D</sub> = power dissipated (W), and
- R<sub>θJA</sub> = junction-to-ambient thermal resistance (°C/W). (4)

The REF19xx maximum junction temperature must not exceed the absolute maximum rating of 150°C.

## 9.4 Device Functional Modes

When the EN pin of the REF19xx is pulled high, the device is in active mode. The device must be in active mode for normal operation. The REF19xx can be placed in a low-power mode by pulling the ENABLE pin low. When in shutdown mode, the output of the device becomes high impedance and the quiescent current of the device reduces to 5 μA in shutdown mode. See the [Electrical Characteristics](#) for logic high and logic low voltage levels.



## 10 Applications and Implementation

### NOTE

Information in the following applications and implementation sections is not part of the TI component specification, and TI does not warrant its accuracy or completeness. TI's customers are responsible for determining suitability of components for their purposes. Customers should validate and test their design implementation to confirm system functionality.

### 10.1 Application Information

The low-drift, bidirectional, single-supply, low-side, current-sensing solution described in this section can accurately detect load currents from  $-2.5\text{ A}$  to  $2.5\text{ A}$ . The linear range of the output is from  $250\text{ mV}$  to  $2.75\text{ V}$ . Positive current is represented by output voltages from  $1.5\text{ V}$  to  $2.75\text{ V}$ , whereas negative current is represented by output voltages from  $250\text{ mV}$  to  $1.5\text{ V}$ . The difference amplifier is the [INA213](#) current-shunt monitor, whose supply and reference voltages are supplied by the low-drift REF1930.

### 10.2 Typical Application

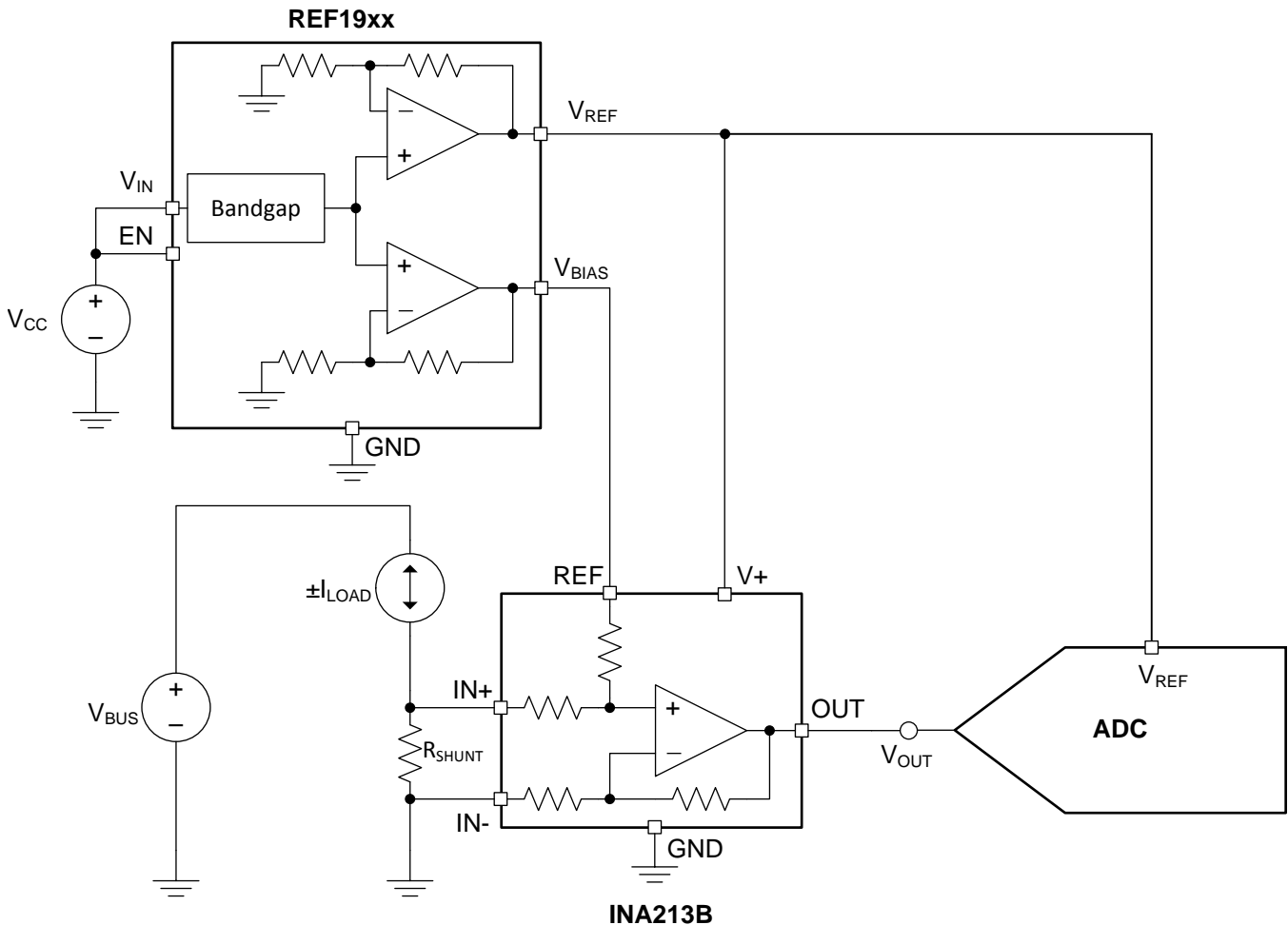

Figure 45. Low-Side, Current-Sensing Application

## Typical Application (continued)

### 10.2.1 Design Requirements

The design requirements are as follows:

1. Supply voltage: 5.0 V
2. Load current:  $\pm 2.5$  A
3. Output: 250 mV to 2.75 V
4. Maximum shunt voltage:  $\pm 25$  mV

### 10.2.2 Detailed Design Procedure

Low-side current sensing is desirable because the common-mode voltage is near ground. Therefore, the current-sensing solution is independent of the bus voltage,  $V_{BUS}$ . When sensing bidirectional currents, use a differential amplifier with a reference pin. This procedure allows for the differentiation between positive and negative currents by biasing the output stage such that it can respond to negative input voltages. There are a variety of methods for supplying power ( $V+$ ) and the reference voltage ( $V_{REF}$ , or  $V_{BIAS}$ ) to the differential amplifier. For a low-drift solution, use a monolithic reference that supplies both power and the reference voltage. Figure 46 shows the general circuit topology for a low-drift, low-side, bidirectional, current-sensing solution. This topology is particularly useful when interfacing with an ADC; see Figure 45. Not only do  $V_{REF}$  and  $V_{BIAS}$  track over temperature, but their matching is much better than alternate topologies. For a more detailed version of the design procedure, refer to TIDU357.

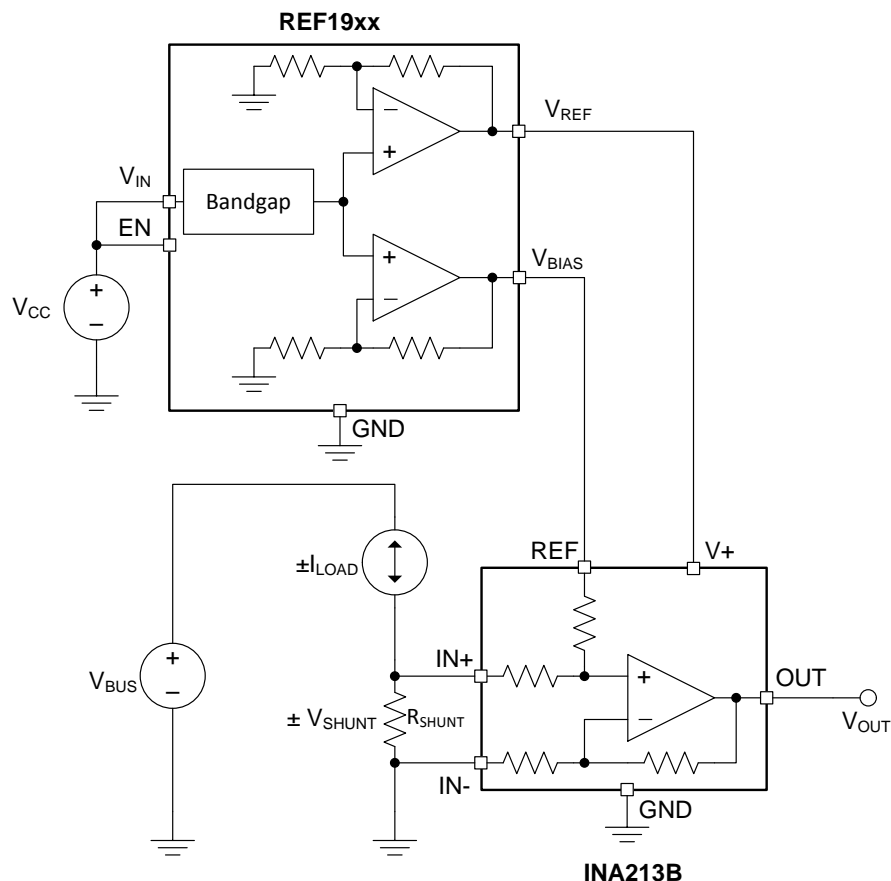

**Figure 46. Low-Drift, Low-side, Bidirectional, Current-Sensing Circuit Topology**

The transfer function for the circuit given in Figure 46 is as shown in Equation 5:

$$\begin{aligned}
 V_{OUT} &= G \cdot (\pm V_{SHUNT}) + V_{BIAS} \\
 &= G \cdot (\pm I_{LOAD} \cdot R_{SHUNT}) + V_{BIAS}
 \end{aligned}
 \tag{5}$$

## Typical Application (continued)

### 10.2.2.1 Shunt Resistor

As illustrated in [Figure 46](#), the value of  $V_{SHUNT}$  is the ground potential for the system load. If the value of  $V_{SHUNT}$  is too large, issues may arise when interfacing with systems whose ground potential is actually 0 V. Also, a value of  $V_{SHUNT}$  that is too negative may violate the input common-mode voltage of the differential amplifier in addition to potential interfacing issues. Therefore, limiting the voltage across the shunt resistor is important. [Equation 6](#) can be used to calculate the maximum value of  $R_{SHUNT}$ .

$$R_{SHUNT(max)} = \frac{V_{SHUNT(max)}}{I_{LOAD(max)}} \quad (6)$$

Given that the maximum shunt voltage is  $\pm 25$  mV and the load current range is  $\pm 2.5$  A, the maximum shunt resistance is calculated as shown in [Equation 7](#).

$$R_{SHUNT(max)} = \frac{V_{SHUNT(max)}}{I_{LOAD(max)}} = \frac{25mV}{2.5A} = 10m\Omega \quad (7)$$

To minimize errors over temperature, select a low-drift shunt resistor. To minimize offset error, select a shunt resistor with the lowest tolerance. For this design, the Y14870R01000B9W resistor is used.

### 10.2.2.2 Differential Amplifier

The differential amplifier used for this design must have the following features:

1. Single supply (3 V),
2. Reference voltage input,
3. Low initial input offset voltage ( $V_{OS}$ ),
4. Low-drift,
5. Fixed gain, and
6. Low-side sensing (input common-mode range below ground).

For this design, a current-shunt monitor (INA213) is used. The INA21x family topology is shown in [Figure 47](#). The INA213B specifications can be found in the [INA213 product data sheet](#).

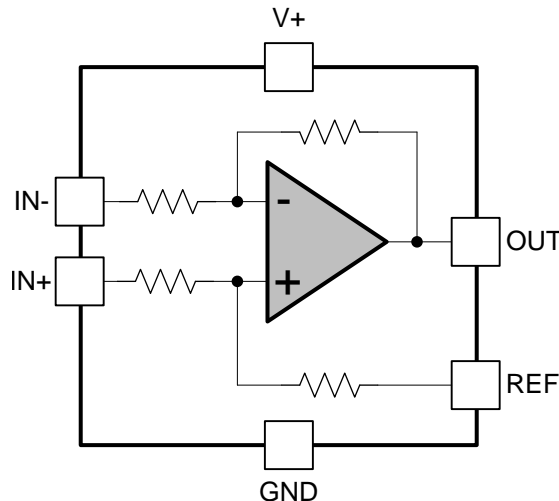

**Figure 47. INA21x Current-Shunt Monitor Topology**

The INA213B is an excellent choice for this application because all the required features are included. In general, instrumentation amplifiers (INAs) do not have the input common-mode swing to ground that is essential for this application. In addition, INAs require external resistors to set their gain, which is not desirable for low-drift applications. Difference amplifiers typically have larger input bias currents, which reduce solution accuracy at small load currents. Difference amplifiers typically have a gain of 1 V/V. When the gain is adjustable, these amplifiers use external resistors that are not conducive to low-drift applications.

## Typical Application (continued)

### 10.2.2.3 Voltage Reference

The voltage reference for this application must have the following features:

1. Dual output (3.0 V and 1.5 V),
2. Low drift, and
3. Low tracking errors between the two outputs.

For this design, the REF1930 is used. The REF19xx topology is as shown in the [Functional Block Diagram](#) section.

The REF1930 is an excellent choice for this application because of its dual output. The temperature drift of 25 ppm/°C and initial accuracy of 0.1% make the errors resulting from the voltage reference minimal in this application. In addition, there is minimal mismatch between the two outputs and both outputs track very well across temperature, as shown in [Figure 48](#) and [Figure 49](#).

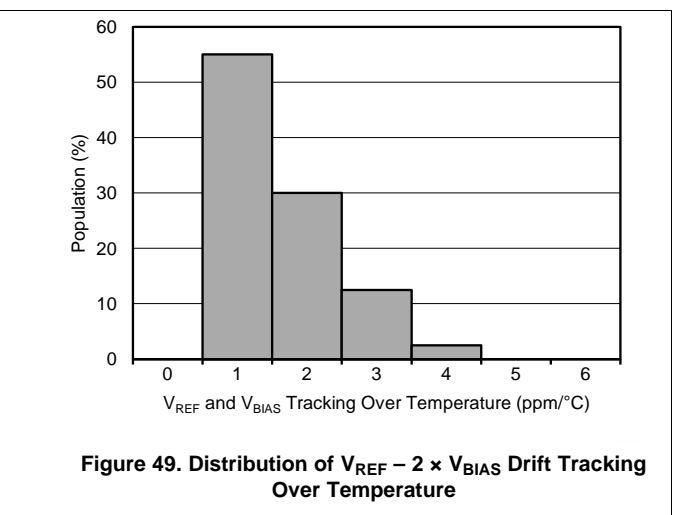
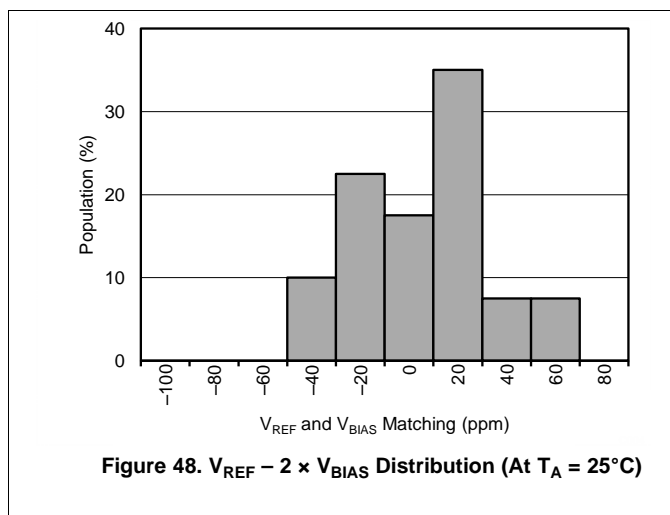

### 10.2.2.4 Results

Table 1 summarizes the measured results.

**Table 1. Measured Results**

ERROR	UNCALIBRATED (%)	CALIBRATED (%)
Error across the full load current range (25°C)	±0.0355	±0.004
Error across the full load current range (-40°C to 125°C)	±0.0522	±0.0606

### 10.2.3 Application Curves

Performing a two-point calibration at 25°C removes the errors associated with offset voltage, gain error, and so forth. Figure 50 to Figure 52 show the measured error at different conditions. For a more detailed description on measurement procedure, calibration, and calculations, please refer to TIDU357.

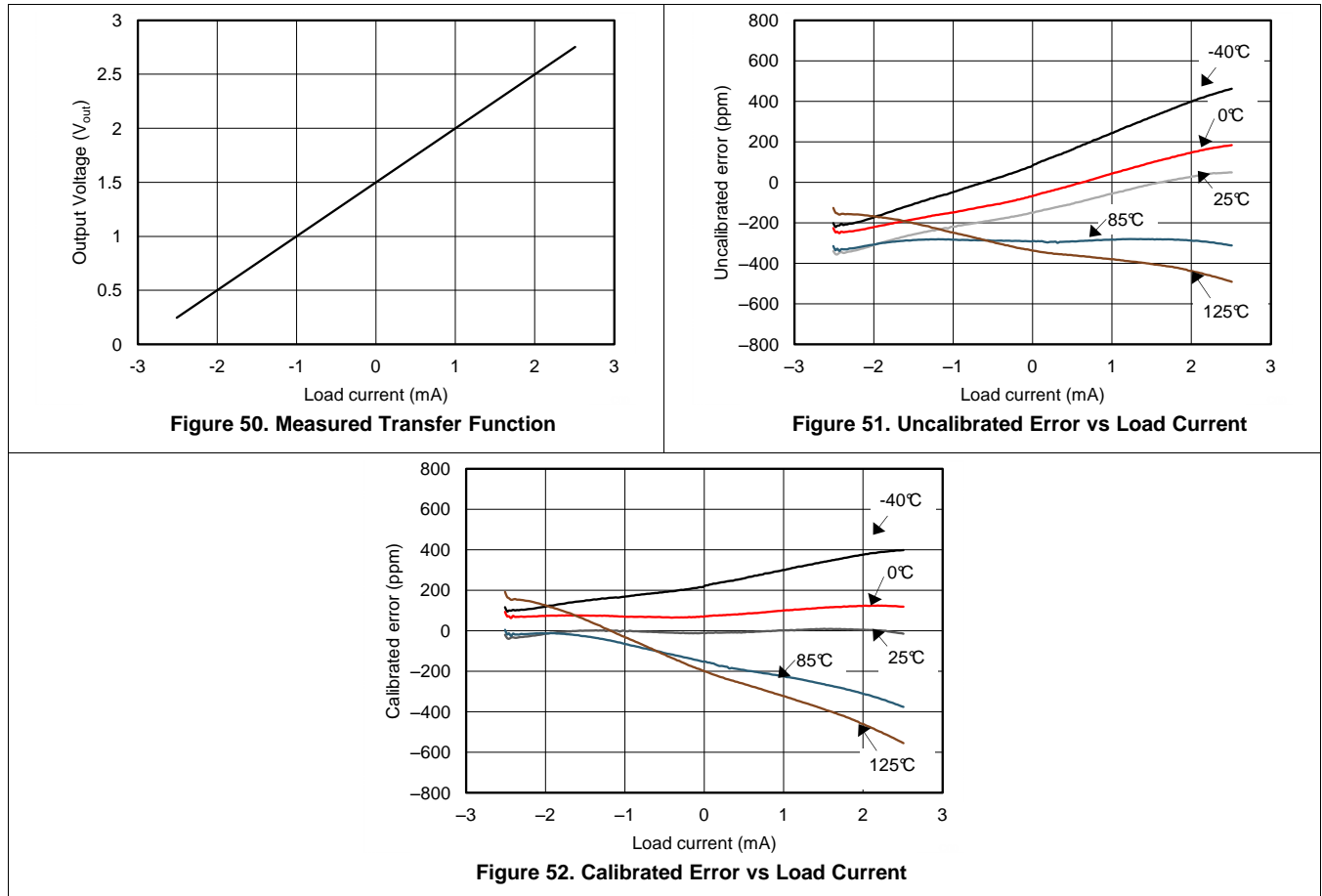

## 11 Power-Supply Recommendations

The REF19xx family of references feature an extremely low-dropout voltage. These references can be operated with a supply of only 20 mV above the output voltage. For loaded reference conditions, a typical dropout voltage versus load is shown in [Figure 53](#). A supply bypass capacitor ranging between 0.1  $\mu\text{F}$  to 10  $\mu\text{F}$  is recommended.

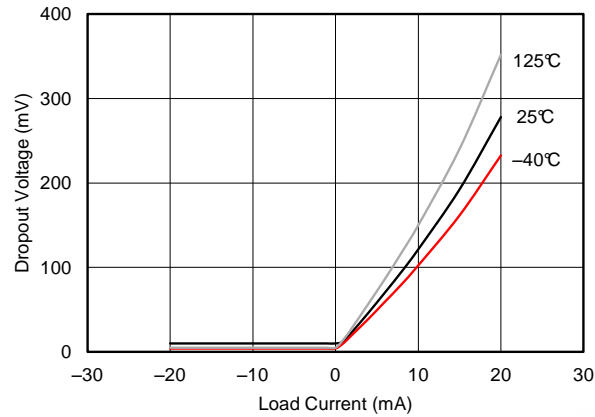

**Figure 53. Dropout Voltage vs Load Current**

## 12 Layout

### 12.1 Layout Guidelines

Figure 54 shows an example of a PCB layout for a data acquisition system using the REF1930. Some key considerations are:

- Connect low-ESR, 0.1- $\mu$ F ceramic bypass capacitors at  $V_{IN}$ ,  $V_{REF}$ , and  $V_{BIAS}$  of the REF1930.
- Decouple other active devices in the system per the device specifications.
- Using a solid ground plane helps distribute heat and reduces electromagnetic interference (EMI) noise pickup.
- Place the external components as close to the device as possible. This configuration prevents parasitic errors (such as the Seebeck effect) from occurring.
- Minimize trace length between the reference and bias connections to the INA and ADC to reduce noise pickup.
- Do not run sensitive analog traces in parallel with digital traces. Avoid crossing digital and analog traces if possible and only make perpendicular crossings when absolutely necessary.

### 12.2 Layout Example

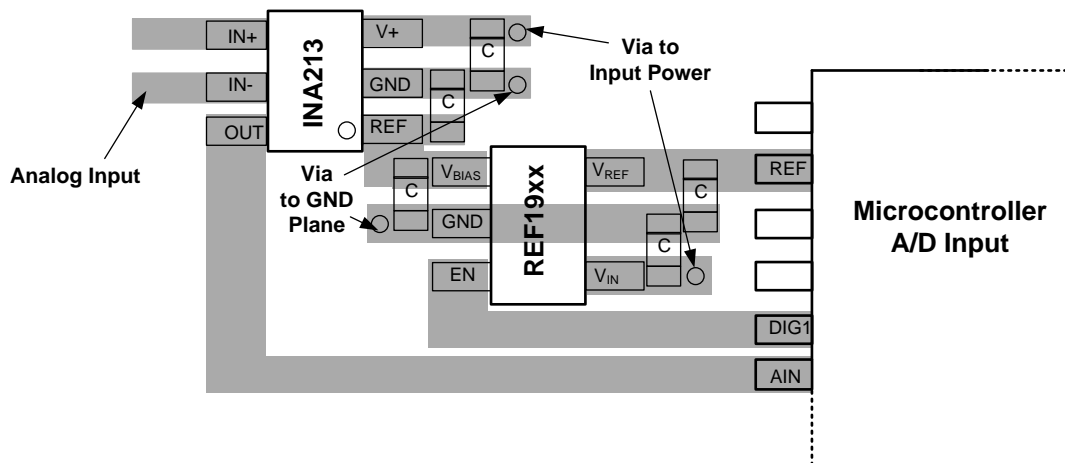

Figure 54. Layout Example

## 13 Device and Documentation Support

### 13.1 Documentation Support

#### 13.1.1 Related Documentation

For related documentation see the following:

- INA213 Data Sheet, [SBOS437](#)
- *Low-Drift Bidirectional Single-Supply Low-Side Current Sensing Reference Design*, [TIDU357](#)

### 13.2 Related Links

The table below lists quick access links. Categories include technical documents, support and community resources, tools and software, and quick access to sample or buy.

**Table 2. Related Links**

PARTS	PRODUCT FOLDER	SAMPLE & BUY	TECHNICAL DOCUMENTS	TOOLS & SOFTWARE	SUPPORT & COMMUNITY
REF1925	<a href="#">Click here</a>	<a href="#">Click here</a>	<a href="#">Click here</a>	<a href="#">Click here</a>	<a href="#">Click here</a>
REF1930	<a href="#">Click here</a>	<a href="#">Click here</a>	<a href="#">Click here</a>	<a href="#">Click here</a>	<a href="#">Click here</a>
REF1933	<a href="#">Click here</a>	<a href="#">Click here</a>	<a href="#">Click here</a>	<a href="#">Click here</a>	<a href="#">Click here</a>
REF1941	<a href="#">Click here</a>	<a href="#">Click here</a>	<a href="#">Click here</a>	<a href="#">Click here</a>	<a href="#">Click here</a>

### 13.3 Trademarks

e-Trim is a trademark of Texas Instruments, Inc.  
All other trademarks are the property of their respective owners.

### 13.4 Electrostatic Discharge Caution



This integrated circuit can be damaged by ESD. Texas Instruments recommends that all integrated circuits be handled with appropriate precautions. Failure to observe proper handling and installation procedures can cause damage.

ESD damage can range from subtle performance degradation to complete device failure. Precision integrated circuits may be more susceptible to damage because very small parametric changes could cause the device not to meet its published specifications.

### 13.5 Glossary

[SLYZ022](#) — *TI Glossary*.

This glossary lists and explains terms, acronyms, and definitions.

## 14 Mechanical, Packaging, and Orderable Information

The following pages include mechanical packaging and orderable information. This information is the most current data available for the designated devices. This data is subject to change without notice and revision of this document. For browser-based versions of this data sheet, refer to the left-hand navigation.



**PACKAGING INFORMATION**

Orderable Device	Status (1)	Package Type	Package Drawing	Pins	Package Qty	Eco Plan (2)	Lead/Ball Finish (6)	MSL Peak Temp (3)	Op Temp (°C)	Device Marking (4/5)	Samples
REF1925AIDDCR	ACTIVE	SOT	DDC	5	3000	Green (RoHS & no Sb/Br)	CU NIPDAU	Level-2-260C-1 YEAR	-40 to 125	GAGM	<a href="#">Samples</a>
REF1925AIDDCT	ACTIVE	SOT	DDC	5	250	Green (RoHS & no Sb/Br)	CU NIPDAU	Level-2-260C-1 YEAR	-40 to 125	GAGM	<a href="#">Samples</a>
REF1930AIDDCR	ACTIVE	SOT	DDC	5	3000	Green (RoHS & no Sb/Br)	CU NIPDAU	Level-2-260C-1 YEAR	-40 to 125	GAHM	<a href="#">Samples</a>
REF1930AIDDCT	ACTIVE	SOT	DDC	5	250	Green (RoHS & no Sb/Br)	CU NIPDAU	Level-2-260C-1 YEAR	-40 to 125	GAHM	<a href="#">Samples</a>
REF1933AIDDCR	ACTIVE	SOT	DDC	5	3000	Green (RoHS & no Sb/Br)	CU NIPDAU	Level-2-260C-1 YEAR	-40 to 125	GAJM	<a href="#">Samples</a>
REF1933AIDDCT	ACTIVE	SOT	DDC	5	250	Green (RoHS & no Sb/Br)	CU NIPDAU	Level-2-260C-1 YEAR	-40 to 125	GAJM	<a href="#">Samples</a>
REF1941AIDDCR	ACTIVE	SOT	DDC	5	3000	Green (RoHS & no Sb/Br)	CU NIPDAU	Level-2-260C-1 YEAR	-40 to 125	GAJM	<a href="#">Samples</a>
REF1941AIDDCT	ACTIVE	SOT	DDC	5	250	Green (RoHS & no Sb/Br)	CU NIPDAU	Level-2-260C-1 YEAR	-40 to 125	GAJM	<a href="#">Samples</a>

(1) The marketing status values are defined as follows:

**ACTIVE:** Product device recommended for new designs.

**LIFEBUY:** TI has announced that the device will be discontinued, and a lifetime-buy period is in effect.

**NRND:** Not recommended for new designs. Device is in production to support existing customers, but TI does not recommend using this part in a new design.

**PREVIEW:** Device has been announced but is not in production. Samples may or may not be available.

**OBSELETE:** TI has discontinued the production of the device.

(2) Eco Plan - The planned eco-friendly classification: Pb-Free (RoHS), Pb-Free (RoHS Exempt), or Green (RoHS & no Sb/Br) - please check <http://www.ti.com/productcontent> for the latest availability information and additional product content details.

**TBD:** The Pb-Free/Green conversion plan has not been defined.

**Pb-Free (RoHS):** TI's terms "Lead-Free" or "Pb-Free" mean semiconductor products that are compatible with the current RoHS requirements for all 6 substances, including the requirement that lead not exceed 0.1% by weight in homogeneous materials. Where designed to be soldered at high temperatures, TI Pb-Free products are suitable for use in specified lead-free processes.

**Pb-Free (RoHS Exempt):** This component has a RoHS exemption for either 1) lead-based flip-chip solder bumps used between the die and package, or 2) lead-based die adhesive used between the die and leadframe. The component is otherwise considered Pb-Free (RoHS compatible) as defined above.

**Green (RoHS & no Sb/Br):** TI defines "Green" to mean Pb-Free (RoHS compatible), and free of Bromine (Br) and Antimony (Sb) based flame retardants (Br or Sb do not exceed 0.1% by weight in homogeneous material)

(3) MSL, Peak Temp. - The Moisture Sensitivity Level rating according to the JEDEC industry standard classifications, and peak solder temperature.

(4) There may be additional marking, which relates to the logo, the lot trace code information, or the environmental category on the device.

(5) Multiple Device Markings will be inside parentheses. Only one Device Marking contained in parentheses and separated by a "~" will appear on a device. If a line is indented then it is a continuation of the previous line and the two combined represent the entire Device Marking for that device.

(6) Lead/Ball Finish - Orderable Devices may have multiple material finish options. Finish options are separated by a vertical ruled line. Lead/Ball Finish values may wrap to two lines if the finish value exceeds the maximum column width.

**Important Information and Disclaimer:**The information provided on this page represents TI's knowledge and belief as of the date that it is provided. TI bases its knowledge and belief on information provided by third parties, and makes no representation or warranty as to the accuracy of such information. Efforts are underway to better integrate information from third parties. TI has taken and continues to take reasonable steps to provide representative and accurate information but may not have conducted destructive testing or chemical analysis on incoming materials and chemicals. TI and TI suppliers consider certain information to be proprietary, and thus CAS numbers and other limited information may not be available for release.

In no event shall TI's liability arising out of such information exceed the total purchase price of the TI part(s) at issue in this document sold by TI to Customer on an annual basis.

**TAPE AND REEL INFORMATION**

**QUADRANT ASSIGNMENTS FOR PIN 1 ORIENTATION IN TAPE**

\*All dimensions are nominal

Device	Package Type	Package Drawing	Pins	SPQ	Reel Diameter (mm)	Reel Width W1 (mm)	A0 (mm)	B0 (mm)	K0 (mm)	P1 (mm)	W (mm)	Pin1 Quadrant
REF1925AIDDCR	SOT	DDC	5	3000	179.0	8.4	3.2	3.2	1.4	4.0	8.0	Q3
REF1925AIDDCT	SOT	DDC	5	250	179.0	8.4	3.2	3.2	1.4	4.0	8.0	Q3
REF1930AIDDCR	SOT	DDC	5	3000	179.0	8.4	3.2	3.2	1.4	4.0	8.0	Q3
REF1930AIDDCT	SOT	DDC	5	250	179.0	8.4	3.2	3.2	1.4	4.0	8.0	Q3
REF1933AIDDCR	SOT	DDC	5	3000	179.0	8.4	3.2	3.2	1.4	4.0	8.0	Q3
REF1933AIDDCT	SOT	DDC	5	250	179.0	8.4	3.2	3.2	1.4	4.0	8.0	Q3
REF1941AIDDCR	SOT	DDC	5	3000	179.0	8.4	3.2	3.2	1.4	4.0	8.0	Q3
REF1941AIDDCT	SOT	DDC	5	250	179.0	8.4	3.2	3.2	1.4	4.0	8.0	Q3

**TAPE AND REEL BOX DIMENSIONS**

\*All dimensions are nominal

Device	Package Type	Package Drawing	Pins	SPQ	Length (mm)	Width (mm)	Height (mm)
REF1925AIDDCR	SOT	DDC	5	3000	195.0	200.0	45.0
REF1925AIDDCT	SOT	DDC	5	250	195.0	200.0	45.0
REF1930AIDDCR	SOT	DDC	5	3000	195.0	200.0	45.0
REF1930AIDDCT	SOT	DDC	5	250	195.0	200.0	45.0
REF1933AIDDCR	SOT	DDC	5	3000	195.0	200.0	45.0
REF1933AIDDCT	SOT	DDC	5	250	195.0	200.0	45.0
REF1941AIDDCR	SOT	DDC	5	3000	195.0	200.0	45.0
REF1941AIDDCT	SOT	DDC	5	250	195.0	200.0	45.0

DDC (R-PDSO-G5)

PLASTIC SMALL-OUTLINE

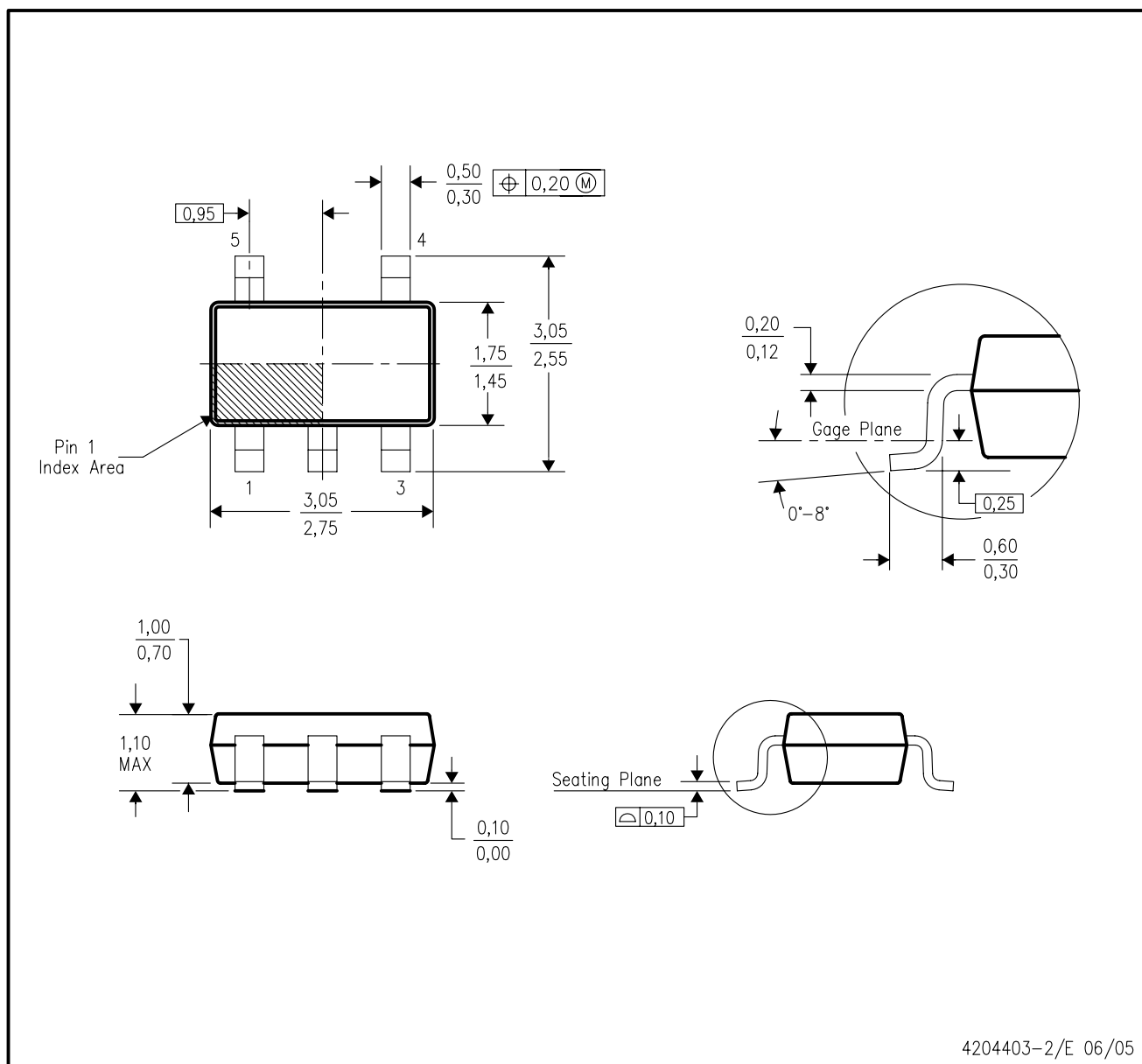

- NOTES:
- All linear dimensions are in millimeters.
  - This drawing is subject to change without notice.
  - Body dimensions do not include mold flash or protrusion.
  - Falls within JEDEC MO-193 variation AB (5 pin).

DDC (R-PDSO-G5)

PLASTIC SMALL OUTLINE

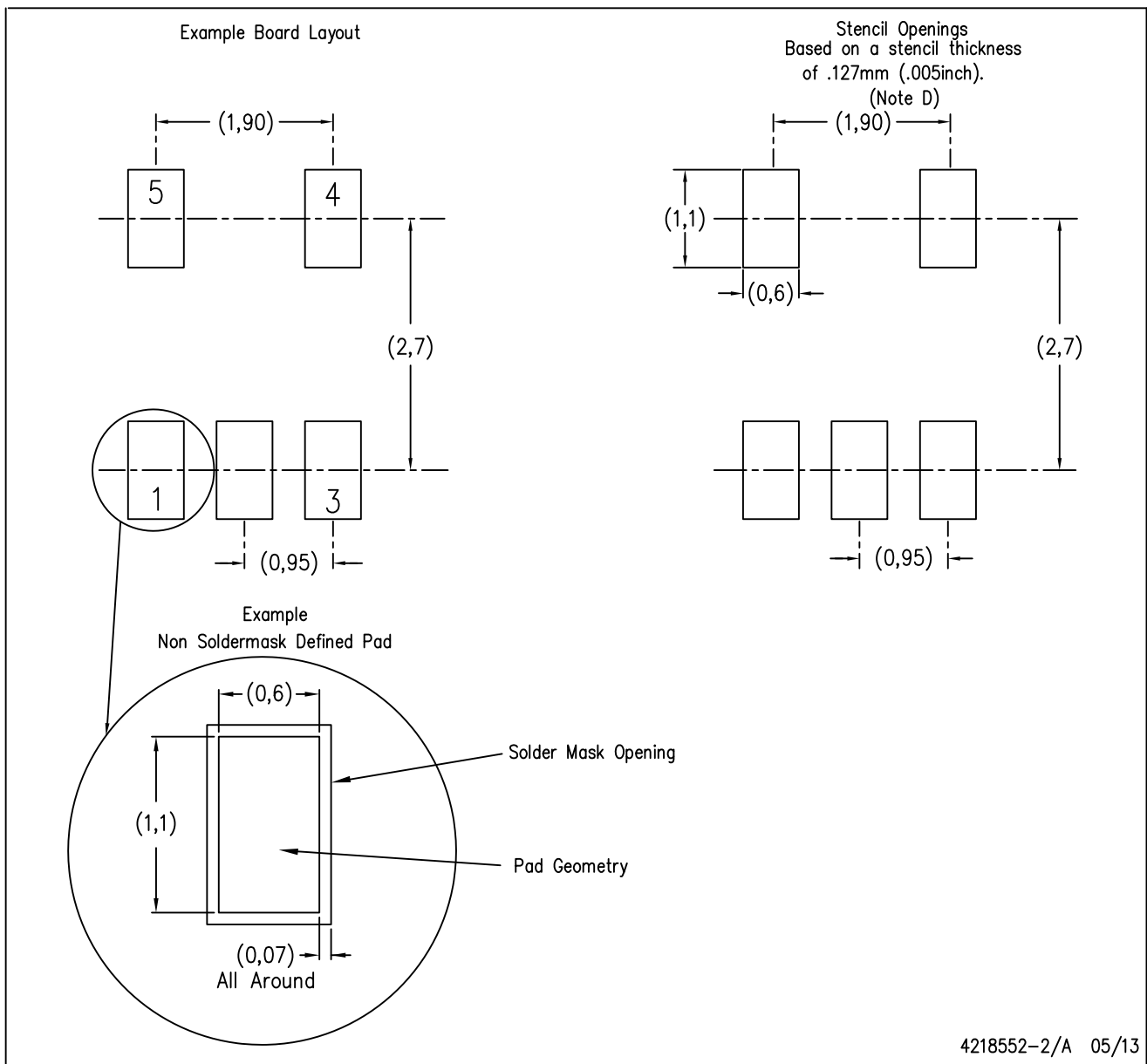

- NOTES:
- A. All linear dimensions are in millimeters.
  - B. This drawing is subject to change without notice.
  - C. Publication IPC-7351 is recommended for alternate designs.
  - D. Laser cutting apertures with trapezoidal walls and also rounding corners will offer better paste release. Customers should contact their board assembly site for stencil design recommendations. Example stencil design based on a 50% volumetric metal load solder paste. Refer to IPC-7525 for other stencil recommendations.

## IMPORTANT NOTICE

Texas Instruments Incorporated and its subsidiaries (TI) reserve the right to make corrections, enhancements, improvements and other changes to its semiconductor products and services per JESD46, latest issue, and to discontinue any product or service per JESD48, latest issue. Buyers should obtain the latest relevant information before placing orders and should verify that such information is current and complete. All semiconductor products (also referred to herein as "components") are sold subject to TI's terms and conditions of sale supplied at the time of order acknowledgment.

TI warrants performance of its components to the specifications applicable at the time of sale, in accordance with the warranty in TI's terms and conditions of sale of semiconductor products. Testing and other quality control techniques are used to the extent TI deems necessary to support this warranty. Except where mandated by applicable law, testing of all parameters of each component is not necessarily performed.

TI assumes no liability for applications assistance or the design of Buyers' products. Buyers are responsible for their products and applications using TI components. To minimize the risks associated with Buyers' products and applications, Buyers should provide adequate design and operating safeguards.

TI does not warrant or represent that any license, either express or implied, is granted under any patent right, copyright, mask work right, or other intellectual property right relating to any combination, machine, or process in which TI components or services are used. Information published by TI regarding third-party products or services does not constitute a license to use such products or services or a warranty or endorsement thereof. Use of such information may require a license from a third party under the patents or other intellectual property of the third party, or a license from TI under the patents or other intellectual property of TI.

Reproduction of significant portions of TI information in TI data books or data sheets is permissible only if reproduction is without alteration and is accompanied by all associated warranties, conditions, limitations, and notices. TI is not responsible or liable for such altered documentation. Information of third parties may be subject to additional restrictions.

Resale of TI components or services with statements different from or beyond the parameters stated by TI for that component or service voids all express and any implied warranties for the associated TI component or service and is an unfair and deceptive business practice. TI is not responsible or liable for any such statements.

Buyer acknowledges and agrees that it is solely responsible for compliance with all legal, regulatory and safety-related requirements concerning its products, and any use of TI components in its applications, notwithstanding any applications-related information or support that may be provided by TI. Buyer represents and agrees that it has all the necessary expertise to create and implement safeguards which anticipate dangerous consequences of failures, monitor failures and their consequences, lessen the likelihood of failures that might cause harm and take appropriate remedial actions. Buyer will fully indemnify TI and its representatives against any damages arising out of the use of any TI components in safety-critical applications.

In some cases, TI components may be promoted specifically to facilitate safety-related applications. With such components, TI's goal is to help enable customers to design and create their own end-product solutions that meet applicable functional safety standards and requirements. Nonetheless, such components are subject to these terms.

No TI components are authorized for use in FDA Class III (or similar life-critical medical equipment) unless authorized officers of the parties have executed a special agreement specifically governing such use.

Only those TI components which TI has specifically designated as military grade or "enhanced plastic" are designed and intended for use in military/aerospace applications or environments. Buyer acknowledges and agrees that any military or aerospace use of TI components which have **not** been so designated is solely at the Buyer's risk, and that Buyer is solely responsible for compliance with all legal and regulatory requirements in connection with such use.

TI has specifically designated certain components as meeting ISO/TS16949 requirements, mainly for automotive use. In any case of use of non-designated products, TI will not be responsible for any failure to meet ISO/TS16949.

### Products

Audio	<a href="http://www.ti.com/audio">www.ti.com/audio</a>
Amplifiers	<a href="http://amplifier.ti.com">amplifier.ti.com</a>
Data Converters	<a href="http://dataconverter.ti.com">dataconverter.ti.com</a>
DLP® Products	<a href="http://www.dlp.com">www.dlp.com</a>
DSP	<a href="http://dsp.ti.com">dsp.ti.com</a>
Clocks and Timers	<a href="http://www.ti.com/clocks">www.ti.com/clocks</a>
Interface	<a href="http://interface.ti.com">interface.ti.com</a>
Logic	<a href="http://logic.ti.com">logic.ti.com</a>
Power Mgmt	<a href="http://power.ti.com">power.ti.com</a>
Microcontrollers	<a href="http://microcontroller.ti.com">microcontroller.ti.com</a>
RFID	<a href="http://www.ti-rfid.com">www.ti-rfid.com</a>
OMAP Applications Processors	<a href="http://www.ti.com/omap">www.ti.com/omap</a>
Wireless Connectivity	<a href="http://www.ti.com/wirelessconnectivity">www.ti.com/wirelessconnectivity</a>

### Applications

Automotive and Transportation	<a href="http://www.ti.com/automotive">www.ti.com/automotive</a>
Communications and Telecom	<a href="http://www.ti.com/communications">www.ti.com/communications</a>
Computers and Peripherals	<a href="http://www.ti.com/computers">www.ti.com/computers</a>
Consumer Electronics	<a href="http://www.ti.com/consumer-apps">www.ti.com/consumer-apps</a>
Energy and Lighting	<a href="http://www.ti.com/energy">www.ti.com/energy</a>
Industrial	<a href="http://www.ti.com/industrial">www.ti.com/industrial</a>
Medical	<a href="http://www.ti.com/medical">www.ti.com/medical</a>
Security	<a href="http://www.ti.com/security">www.ti.com/security</a>
Space, Avionics and Defense	<a href="http://www.ti.com/space-avionics-defense">www.ti.com/space-avionics-defense</a>
Video and Imaging	<a href="http://www.ti.com/video">www.ti.com/video</a>

### TI E2E Community

[e2e.ti.com](http://e2e.ti.com)