

PZTA42T1G

High Voltage Transistor Surface Mount

NPN Silicon

Features

- PZTA42T1G is Complement to PZTA92T1G
- S Prefix for Automotive and Other Applications Requiring Unique Site and Control Change Requirements; AEC-Q101 Qualified and PPAP Capable
- These Devices are Pb-Free, Halogen Free/BFR Free and are RoHS Compliant

MAXIMUM RATINGS ($T_C = 25^\circ\text{C}$ unless otherwise noted)

Rating	Symbol	Value	Unit
Collector-Emitter Voltage (Open Base)	V_{CEO}	300	Vdc
Collector-Base Voltage (Open Emitter)	V_{CBO}	300	Vdc
Emitter-Base Voltage (Open Collector)	V_{EBO}	6.0	Vdc
Collector Current (DC)	I_C	500	mAdc
Total Power Dissipation @ $T_A = 25^\circ\text{C}$ (Note 1)	P_D	1.5	W
Storage Temperature Range	T_{stg}	-65 to +150	$^\circ\text{C}$
Junction Temperature	T_J	150	$^\circ\text{C}$

Stresses exceeding those listed in the Maximum Ratings table may damage the device. If any of these limits are exceeded, device functionality should not be assumed, damage may occur and reliability may be affected.

1. Device mounted on a FR-4 glass epoxy printed circuit board
1.575 in x 1.575 in x 0.0625 in; mounting pad for the collector lead = 0.93 sq in.

THERMAL CHARACTERISTICS

Characteristic	Symbol	Max	Unit
Thermal Resistance, Junction-to-Ambient (Note 2)	$R_{\theta JA}$	83.3	$^\circ\text{C/W}$

2. Device mounted on a FR-4 glass epoxy printed circuit board
1.575 in x 1.575 in x 0.0625 in; mounting pad for the collector lead = 0.93 sq in.



ON Semiconductor®

www.onsemi.com

SOT-223 PACKAGE NPN SILICON HIGH VOLTAGE TRANSISTOR SURFACE MOUNT

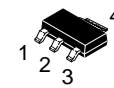
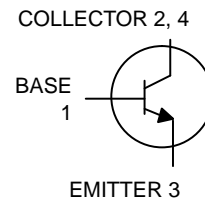

SOT-223
CASE 318E
STYLE 1

MARKING DIAGRAM

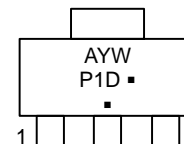

P1D = Specific Device Code
A = Assembly Location
Y = Year
W = Work Week
▪ = Pb-Free Package

(Note: Microdot may be in either location)

ORDERING INFORMATION

Device	Package	Shipping†
PZTA42T1G	SOT-223 (Pb-Free)	1,000 / Tape & Reel
SPZTA42T1G	SOT-223 (Pb-Free)	1,000 / Tape & Reel

†For information on tape and reel specifications, including part orientation and tape sizes, please refer to our Tape and Reel Packaging Specifications Brochure, BRD8011/D.

PZTA42T1G

ELECTRICAL CHARACTERISTICS ($T_A = 25^\circ\text{C}$ unless otherwise noted)

Characteristics	Symbol	Min	Max	Unit
OFF CHARACTERISTICS				
Collector-Emitter Breakdown Voltage (Note 3) ($I_C = 1.0\text{ mA}$, $I_B = 0$)	$V_{(BR)CEO}$	300	–	Vdc
Collector-Base Breakdown Voltage ($I_C = 100\text{ }\mu\text{A}$, $I_E = 0$)	$V_{(BR)CBO}$	300	–	Vdc
Emitter-Base Breakdown Voltage ($I_E = 100\text{ }\mu\text{A}$, $I_C = 0$)	$V_{(BR)EBO}$	6.0	–	Vdc
Collector-Base Cutoff Current ($V_{CB} = 200\text{ Vdc}$, $I_E = 0$)	I_{CBO}	–	0.1	μA
Emitter-Base Cutoff Current ($V_{BE} = 6.0\text{ Vdc}$, $I_C = 0$)	I_{EBO}	–	0.1	μA

ON CHARACTERISTICS

DC Current Gain ($I_C = 1.0\text{ mA}$, $V_{CE} = 10\text{ Vdc}$) ($I_C = 10\text{ mA}$, $V_{CE} = 10\text{ Vdc}$) ($I_C = 30\text{ mA}$, $V_{CE} = 10\text{ Vdc}$)	h_{FE}	25 40 40	– – –	–
---	----------	----------------	-------------	---

DYNAMIC CHARACTERISTICS

Current-Gain – Bandwidth Product ($I_C = 10\text{ mA}$, $V_{CE} = 20\text{ Vdc}$, $f = 100\text{ MHz}$)	f_T	50	–	MHz
Feedback Capacitance ($V_{CB} = 20\text{ Vdc}$, $I_E = 0$, $f = 1.0\text{ MHz}$)	C_{re}	–	3.0	pF
Collector-Emitter Saturation Voltage ($I_C = 20\text{ mA}$, $I_B = 2.0\text{ mA}$)	$V_{CE(sat)}$	–	0.5	Vdc
Base-Emitter Saturation Voltage ($I_C = 20\text{ mA}$, $I_B = 2.0\text{ mA}$)	$V_{BE(sat)}$	–	0.9	Vdc

3. Pulse Test Conditions, $t_p = 300\text{ }\mu\text{s}$, $\delta = 0.02$.

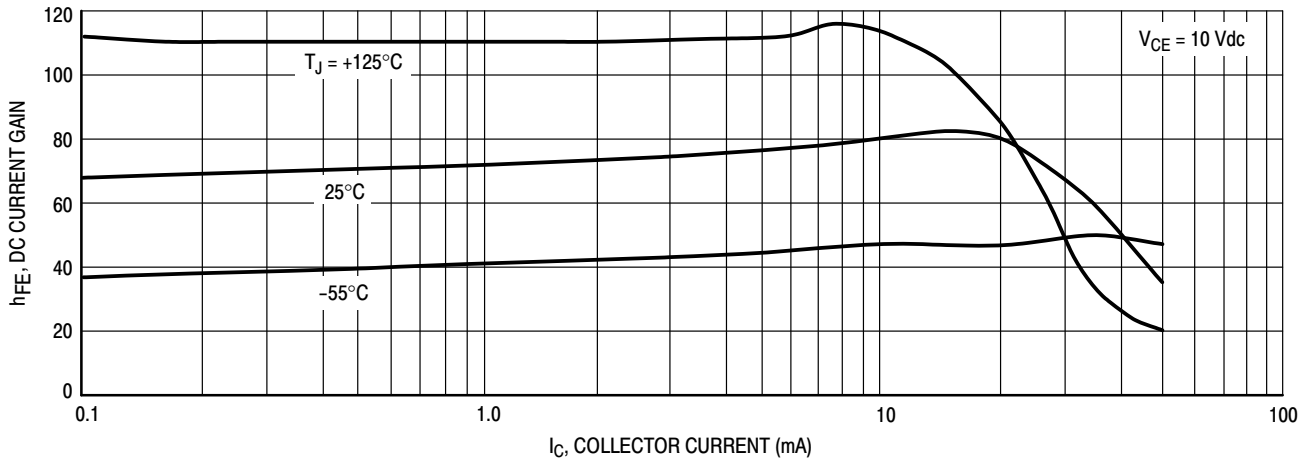

Figure 1. DC Current Gain

PZTA42T1G

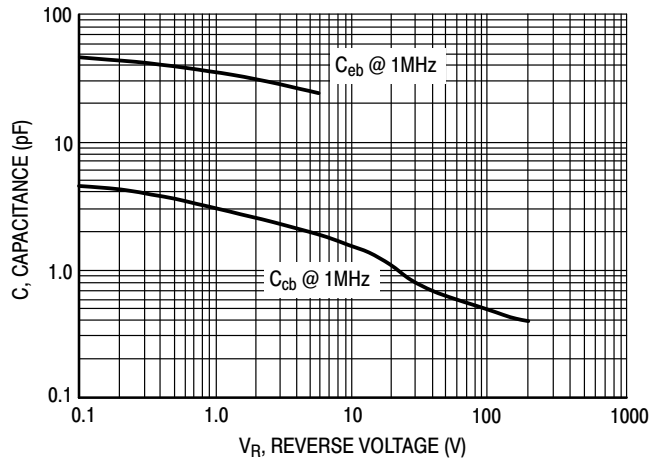

Figure 2. Capacitance

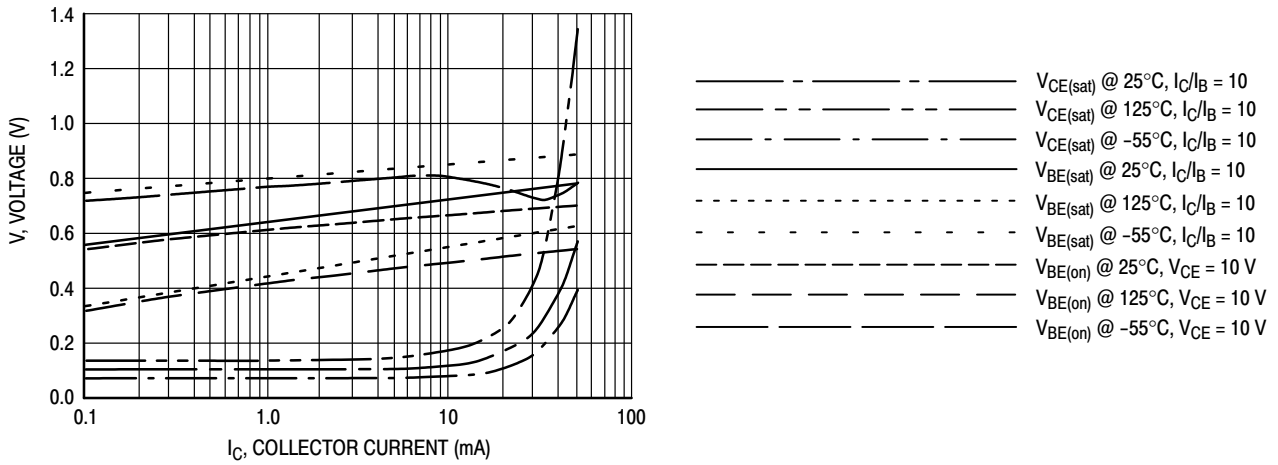

Figure 3. "ON" Voltages

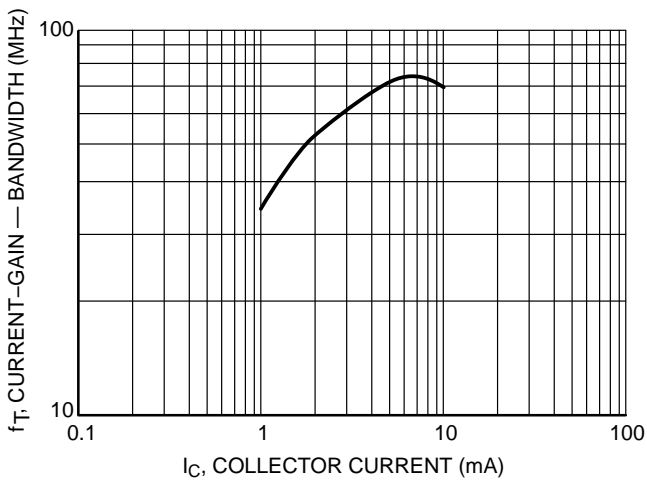

Figure 4. Current Gain Bandwidth Product

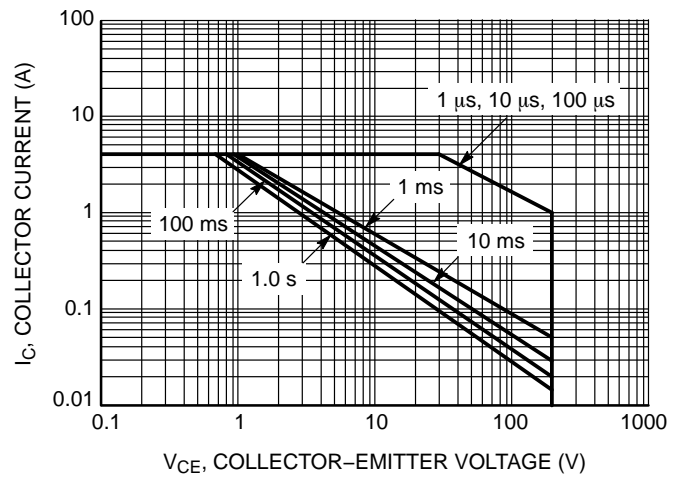
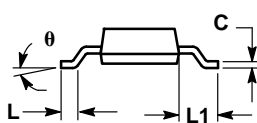
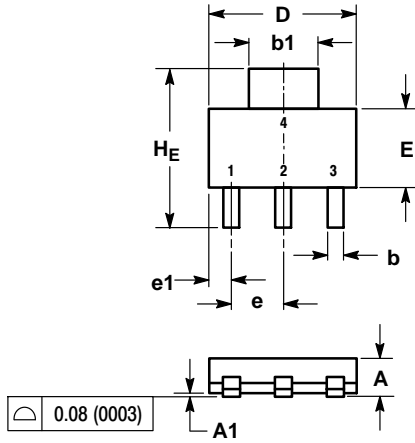

Figure 5. Safe Operating Area

PZTA42T1G

PACKAGE DIMENSIONS

SOT-223 (TO-261)
CASE 318E-04
ISSUE N



NOTES:
1. DIMENSIONING AND TOLERANCING PER ASME Y14.5M, 1994.
2. CONTROLLING DIMENSION: INCH.

DIM	MILLIMETERS			INCHES		
	MIN	NOM	MAX	MIN	NOM	MAX
A	1.50	1.63	1.75	0.060	0.064	0.068
A1	0.02	0.06	0.10	0.001	0.002	0.004
b	0.60	0.75	0.89	0.024	0.030	0.035
b1	2.90	3.06	3.20	0.115	0.121	0.126
c	0.24	0.29	0.35	0.009	0.012	0.014
D	6.30	6.50	6.70	0.249	0.256	0.263
E	3.30	3.50	3.70	0.130	0.138	0.145
e	2.20	2.30	2.40	0.087	0.091	0.094
e1	0.85	0.94	1.05	0.033	0.037	0.041
L	0.20	---	---	0.008	---	---
L1	1.50	1.75	2.00	0.060	0.069	0.078
HE	6.70	7.00	7.30	0.264	0.276	0.287
θ	0°	-	10°	0°	-	10°

STYLE 1:
PIN 1. BASE
2. COLLECTOR
3. EMITTER
4. COLLECTOR

SOLDERING FOOTPRINT*

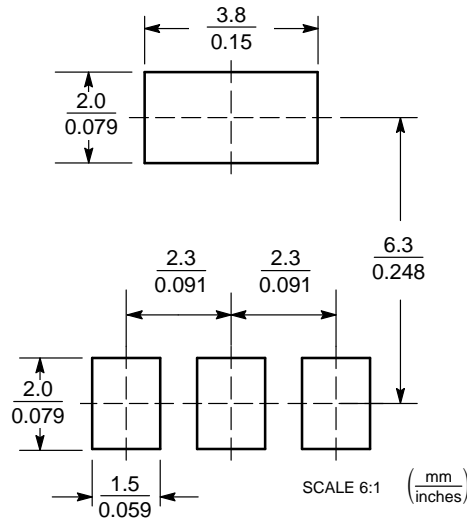

*For additional information on our Pb-Free strategy and soldering details, please download the ON Semiconductor Soldering and Mounting Techniques Reference Manual, SOLDERRM/D.

ON Semiconductor and the are registered trademarks of Semiconductor Components Industries, LLC (SCILLC) or its subsidiaries in the United States and/or other countries. SCILLC owns the rights to a number of patents, trademarks, copyrights, trade secrets, and other intellectual property. A listing of SCILLC's product/patent coverage may be accessed at www.onsemi.com/site/pdf/Patent-Marking.pdf. SCILLC reserves the right to make changes without further notice to any products herein. SCILLC makes no warranty, representation or guarantee regarding the suitability of its products for any particular purpose, nor does SCILLC assume any liability arising out of the application or use of any product or circuit, and specifically disclaims any and all liability, including without limitation special, consequential or incidental damages. "Typical" parameters which may be provided in SCILLC data sheets and/or specifications can and do vary in different applications and actual performance may vary over time. All operating parameters, including "Typicals" must be validated for each customer application by customer's technical experts. SCILLC does not convey any license under its patent rights nor the rights of others. SCILLC products are not designed, intended, or authorized for use as components in systems intended for surgical implant into the body, or other applications intended to support or sustain life, or for any other application in which the failure of the SCILLC product could create a situation where personal injury or death may occur. Should Buyer purchase or use SCILLC products for any such unintended or unauthorized application, Buyer shall indemnify and hold SCILLC and its officers, employees, subsidiaries, affiliates, and distributors harmless against all claims, costs, damages, and expenses, and reasonable attorney fees arising out of, directly or indirectly, any claim of personal injury or death associated with such unintended or unauthorized use, even if such claim alleges that SCILLC was negligent regarding the design or manufacture of the part. SCILLC is an Equal Opportunity/Affirmative Action Employer. This literature is subject to all applicable copyright laws and is not for resale in any manner.

PUBLICATION ORDERING INFORMATION

LITERATURE FULFILLMENT:
Literature Distribution Center for ON Semiconductor
19521 E. 32nd Pkwy, Aurora, Colorado 80011 USA
Phone: 303-675-2175 or 800-344-3860 Toll Free USA/Canada
Fax: 303-675-2176 or 800-344-3867 Toll Free USA/Canada
Email: orderlit@onsemi.com

N. American Technical Support: 800-282-9855 Toll Free
USA/Canada
Europe, Middle East and Africa Technical Support:
Phone: 421 33 790 2910
Japan Customer Focus Center
Phone: 81-3-5817-1050

ON Semiconductor Website: www.onsemi.com
Order Literature: <http://www.onsemi.com/orderlit>
For additional information, please contact your local Sales Representative