

## 5MHz, Low-Noise, Single, Dual, Quad CMOS Operational Amplifiers

Check for Samples: [OPA377](#), [OPA2377](#), [OPA4377](#)

### FEATURES

- **GAIN BANDWIDTH PRODUCT: 5.5MHz**
- **LOW NOISE: 7.5nV/√Hz at 1kHz**
- **OFFSET VOLTAGE: 1mV (max)**
- **INPUT BIAS CURRENT: 0.2pA**
- **RAIL-TO-RAIL OUTPUT**
- **UNITY-GAIN STABLE**
- **EMI INPUT FILTERING**
- **QUIESCENT CURRENT: 0.76mA/ch**
- **SUPPLY VOLTAGE: 2.2V to 5.5V**
- **SMALL PACKAGES:  
SC70, SOT23, and MSOP**

### APPLICATIONS

- **PHOTODIODE PREAMP**
- **PIEZOELECTRIC SENSOR PREAMP**
- **SENSOR SIGNAL CONDITIONING**
- **AUDIO EQUIPMENT**
- **ACTIVE FILTERS**

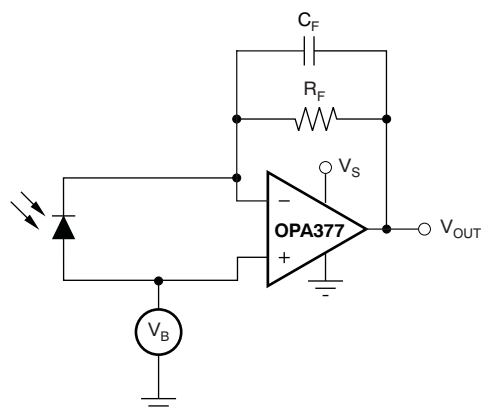

Photodiode Preamplifier

### DESCRIPTION

The OPA377 family of operational amplifiers are wide-bandwidth CMOS amplifiers that provide very low noise, low input bias current, and low offset voltage while operating on a low quiescent current of 0.76mA (typ).

The OPA377 op amps are optimized for low-voltage, single-supply applications. The exceptional combination of ac and dc performance make them ideal for a wide range of applications, including small signal conditioning, audio, and active filters. In addition, these parts have a wide supply range with excellent PSRR, making them attractive for applications that run directly from batteries without regulation.

The OPA377 is available in the SC70-5, SOT23-5, and SO-8 packages. The dual OPA2377 is offered in the SO-8 and MSOP-8, and the quad OPA4377 in the TSSOP-14 packages. All versions are specified for operation from  $-40^{\circ}\text{C}$  to  $+125^{\circ}\text{C}$ .

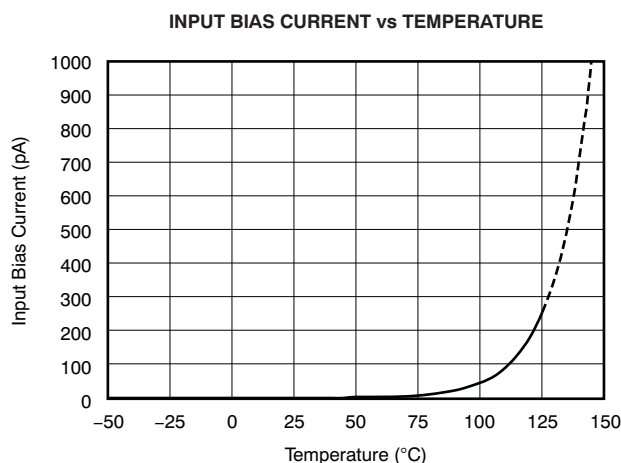

Please be aware that an important notice concerning availability, standard warranty, and use in critical applications of Texas Instruments semiconductor products and disclaimers thereto appears at the end of this data sheet.

All trademarks are the property of their respective owners.



This integrated circuit can be damaged by ESD. Texas Instruments recommends that all integrated circuits be handled with appropriate precautions. Failure to observe proper handling and installation procedures can cause damage.

ESD damage can range from subtle performance degradation to complete device failure. Precision integrated circuits may be more susceptible to damage because very small parametric changes could cause the device not to meet its published specifications.

## ABSOLUTE MAXIMUM RATING<sup>(1)</sup>

Over operating free-air temperature range, unless otherwise noted.

		OPA377, OPA2377, OPA4377	UNIT
Supply Voltage	$V_S = (V+) - (V-)$	+7	V
Signal Input Terminals	Voltage <sup>(2)</sup>	$(V-) - 0.5$ to $(V+) + 0.5$	V
	Current <sup>(2)</sup>	±10	mA
Output Short-Circuit <sup>(3)</sup>		Continuous	
Operating Temperature	$T_A$	–40 to +150	°C
Storage Temperature	$T_A$	–65 to +150	°C
Junction Temperature	$T_J$	+150	°C
ESD Rating	Human Body Model	4000	V
	Charged Device Model	1000	V
	Machine Model	200	V

- (1) Stresses above these ratings may cause permanent damage. Exposure to absolute maximum conditions for extended periods may degrade device reliability. These are stress ratings only, and functional operation of the device at these or any other conditions beyond those specified is not supported.
- (2) Input terminals are diode-clamped to the power-supply rails. Input signals that can swing more than 0.5V beyond the supply rails should be current limited to 10mA or less.
- (3) Short-circuit to ground, one amplifier per package.

## PACKAGE INFORMATION<sup>(1)</sup>

PRODUCT	PACKAGE-LEAD	PACKAGE DESIGNATOR	PACKAGE MARKING
OPA377	SC70-5	DCK	OP377A
	SOT23-5	DBV	OP377A
	SO-8	D	OP377A
OPA2377	SO-8	D	O2377A
	MSOP-8	DGK	OTAQ
OPA4377	TSSOP-14	PW	O4377A

- (1) For the most current package and ordering information, see the Package Option Addendum at the end of this document, or visit the device product folder at [www.ti.com](http://www.ti.com).

**ELECTRICAL CHARACTERISTICS:  $V_S = +2.2V$  to  $+5.5V$** 
**Boldface** limits apply over the specified temperature range:  $T_A = -40^\circ\text{C}$  to  $+125^\circ\text{C}$ .

At  $T_A = +25^\circ\text{C}$ ,  $R_L = 10\text{k}\Omega$  connected to  $V_S/2$ ,  $V_{CM} = V_S/2$ , and  $V_{OUT} = V_S/2$ , unless otherwise noted.

PARAMETERS		CONDITIONS	OPA377, OPA2377, OPA4377			UNIT
			MIN	TYP	MAX	
<b>OFFSET VOLTAGE</b>						
Input Offset Voltage	$V_{OS}$	$V_S = +5V$		0.25	1	mV
<b>vs Temperature</b>	$dV_{OS}/dT$	$-40^\circ\text{C}$ to $+125^\circ\text{C}$		<b>0.32</b>	<b>2</b>	$\mu\text{V}/^\circ\text{C}$
vs Power Supply	PSRR	$V_S = +2.2V$ to $+5.5V$ , $V_{CM} < (V+) - 1.3V$		5	28	$\mu\text{V}/V$
<b>Over Temperature</b>		$V_S = +2.2V$ to $+5.5V$ , $V_{CM} < (V+) - 1.3V$		<b>5</b>		$\mu\text{V}/V$
Channel Separation, dc (dual, quad)				0.5		$\mu\text{V}/V$
<b>INPUT BIAS CURRENT</b>						
Input Bias Current	$I_B$			$\pm 0.2$	$\pm 10$	pA
<b>Over Temperature</b>			See <a href="#">Typical Characteristics</a>			<b>pA</b>
Input Offset Current	$I_{OS}$			$\pm 0.2$	$\pm 10$	pA
<b>NOISE</b>						
Input Voltage Noise,	$e_n$	$f = 0.1\text{Hz}$ to $10\text{Hz}$		0.8		$\mu\text{V}_{PP}$
Input Voltage Noise Density	$e_n$	$f = 1\text{kHz}$		7.5		$\text{nV}/\sqrt{\text{Hz}}$
Input Current Noise	$i_n$	$f = 1\text{kHz}$		2		$\text{fA}/\sqrt{\text{Hz}}$
<b>INPUT VOLTAGE RANGE</b>						
Common-Mode Voltage Range	$V_{CM}$		$(V-) - 0.1$		$(V+) + 0.1$	V
Common-Mode Rejection Ratio	CMRR	$(V-) < V_{CM} < (V+) - 1.3V$	70	90		dB
<b>INPUT CAPACITANCE</b>						
Differential				6.5		pF
Common-Mode				13		pF
<b>OPEN-LOOP GAIN</b>						
Open-Loop Voltage Gain	$A_{OL}$	$50\text{mV} < V_O < (V+) - 50\text{mV}$ , $R_L = 10\text{k}\Omega$	112	134		dB
		$100\text{mV} < V_O < (V+) - 100\text{mV}$ , $R_L = 2\text{k}\Omega$		126		dB
<b>FREQUENCY RESPONSE</b>						
		$V_S = 5.5V$				
Gain-Bandwidth Product	GBW			5.5		MHz
Slew Rate	SR	$G = +1$		2		$\text{V}/\mu\text{s}$
Settling Time 0.1%	$t_s$	2V Step, $G = +1$		1.6		$\mu\text{s}$
Settling Time 0.01%	$t_s$	2V Step, $G = +1$		2		$\mu\text{s}$
Overload Recovery Time		$V_{IN} \times \text{Gain} > V_S$		0.33		$\mu\text{s}$
THD + Noise	THD+N	$V_O = 1V_{RMS}$ , $G = +1$ , $f = 1\text{kHz}$ , $R_L = 10\text{k}\Omega$		0.00027		%
<b>OUTPUT</b>						
Voltage Output Swing from Rail		$R_L = 10\text{k}\Omega$		10	20	mV
<b>Over Temperature</b>		$R_L = 10\text{k}\Omega$			<b>40</b>	<b>mV</b>
Short-Circuit Current	$I_{SC}$			+30/-50		mA
Capacitive Load Drive	$C_{LOAD}$		See <a href="#">Typical Characteristics</a>			
Open-Loop Output Impedance	$R_O$			150		$\Omega$
<b>POWER SUPPLY</b>						
Specified Voltage Range	$V_S$		2.2		5.5	V
Quiescent Current per amplifier	$I_Q$	$I_O = 0$ , $V_S = +5.5V$		0.76	1.05	mA
<b>Over Temperature</b>					<b>1.2</b>	<b>mA</b>
<b>TEMPERATURE RANGE</b>						
Specified Range			-40		+125	$^\circ\text{C}$
Thermal Resistance	$\theta_{JA}$					$^\circ\text{C}/\text{W}$
SC70-5				250		$^\circ\text{C}/\text{W}$
SOT23-5				200		$^\circ\text{C}/\text{W}$
MSOP-8, SO-8, TSSOP-14				150		$^\circ\text{C}/\text{W}$

**PIN CONFIGURATIONS**

**OPA377  
 SOT23-5  
 (TOP VIEW)**

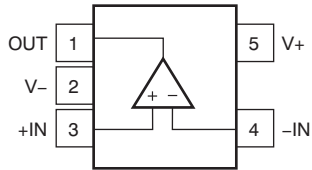

**OPA377  
 SO-8  
 (TOP VIEW)**

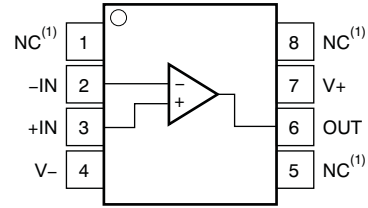

**OPA377  
 SC70-5  
 (TOP VIEW)**

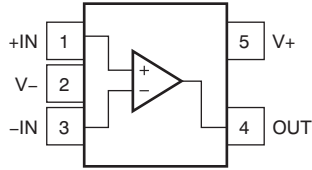

**OPA2377  
 SO-8, MSOP-8  
 (TOP VIEW)**

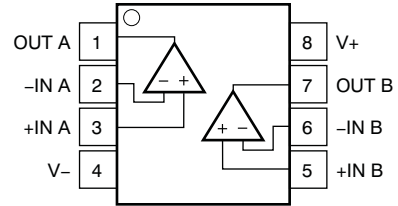

**OPA4377  
 TSSOP-14  
 (TOP VIEW)**

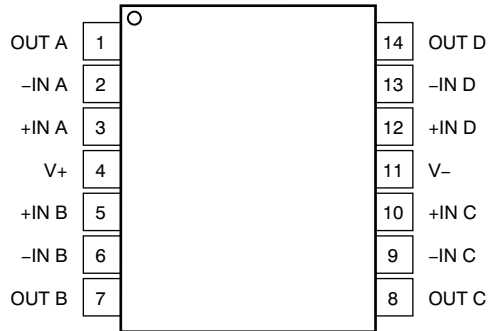

- (1) NC denotes no internal connection.
- (2) Connect thermal die to V-.

## TYPICAL CHARACTERISTICS

At  $T_A = +25^\circ\text{C}$ ,  $V_S = +5\text{V}$ ,  $R_L = 10\text{k}\Omega$  connected to  $V_S/2$ ,  $V_{CM} = V_S/2$ , and  $V_{OUT} = V_S/2$ , unless otherwise noted.

**OPEN-LOOP GAIN/PHASE vs FREQUENCY**

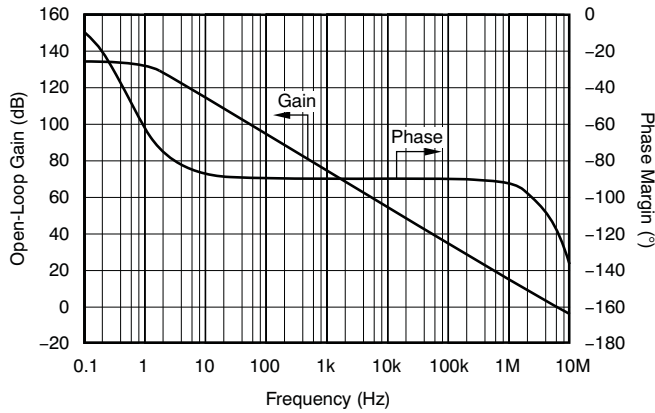

Figure 1.

**POWER-SUPPLY AND COMMON-MODE REJECTION RATIO vs FREQUENCY**

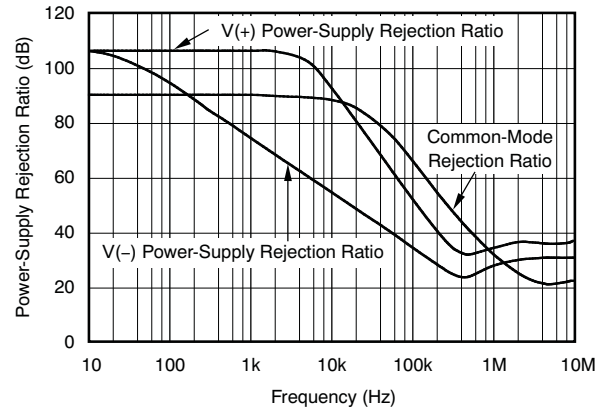

Figure 2.

**OPEN-LOOP GAIN AND POWER-SUPPLY REJECTION RATIO vs TEMPERATURE**

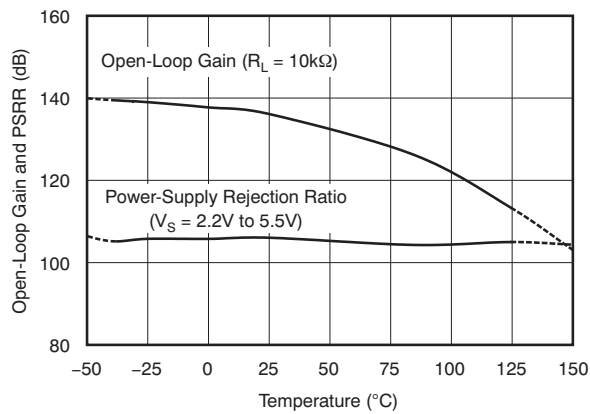

Figure 3.

**0.1Hz to 10Hz INPUT VOLTAGE NOISE**

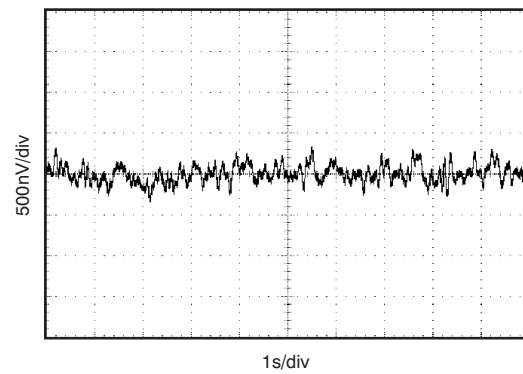

Figure 4.

**INPUT VOLTAGE NOISE SPECTRAL DENSITY**

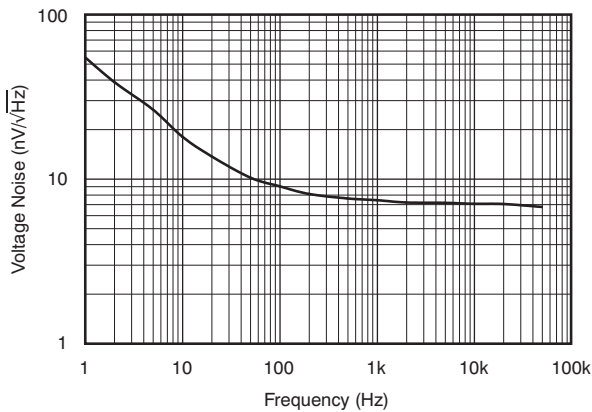

Figure 5.

**TOTAL HARMONIC DISTORTION + NOISE vs FREQUENCY**

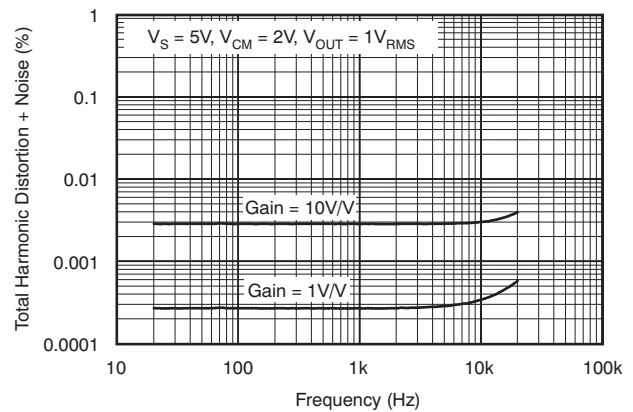

Figure 6.

**TYPICAL CHARACTERISTICS (continued)**

At  $T_A = +25^\circ\text{C}$ ,  $V_S = +5\text{V}$ ,  $R_L = 10\text{k}\Omega$  connected to  $V_S/2$ ,  $V_{CM} = V_S/2$ , and  $V_{OUT} = V_S/2$ , unless otherwise noted.

**COMMON-MODE REJECTION RATIO  
 vs TEMPERATURE**

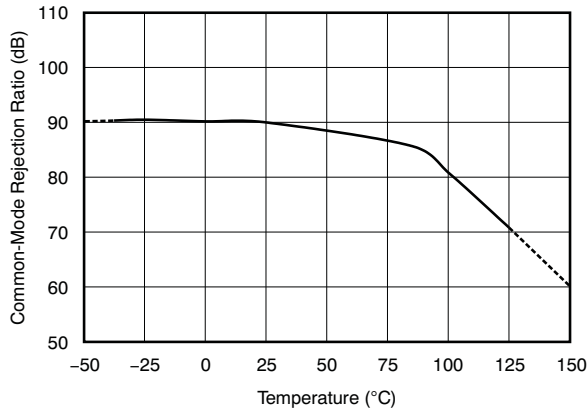

Figure 7.

**QUIESCENT CURRENT  
 vs TEMPERATURE**

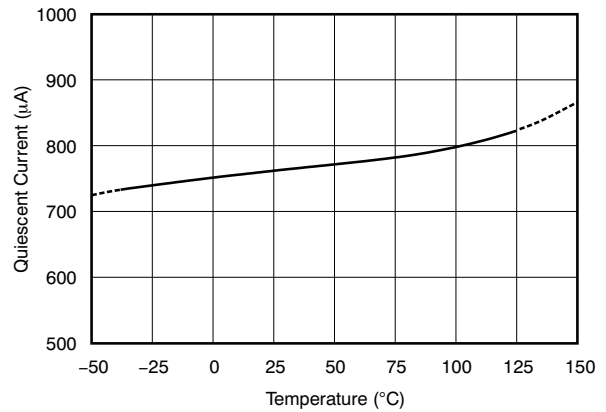

Figure 8.

**QUIESCENT AND SHORT-CIRCUIT CURRENT  
 vs SUPPLY VOLTAGE**

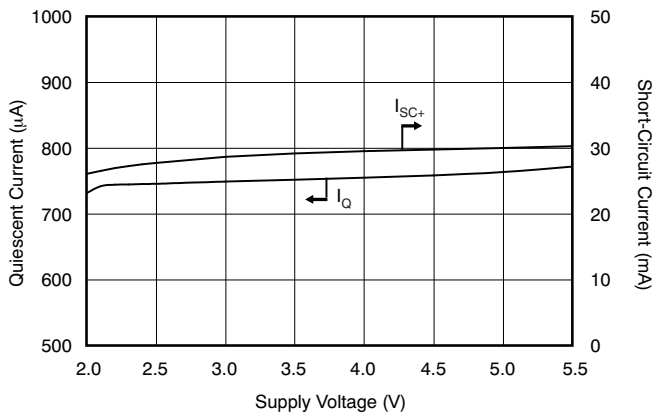

Figure 9.

**SHORT-CIRCUIT CURRENT  
 vs TEMPERATURE**

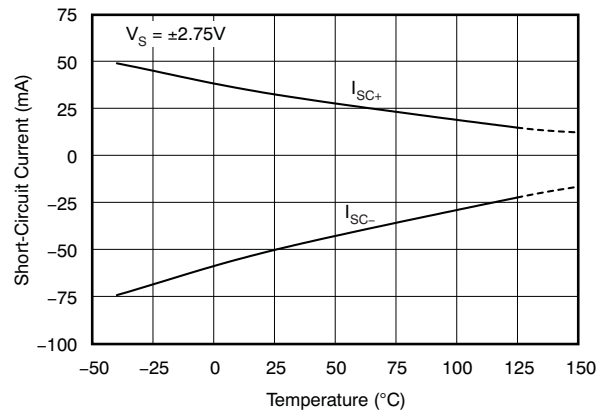

Figure 10.

**INPUT BIAS CURRENT vs TEMPERATURE**

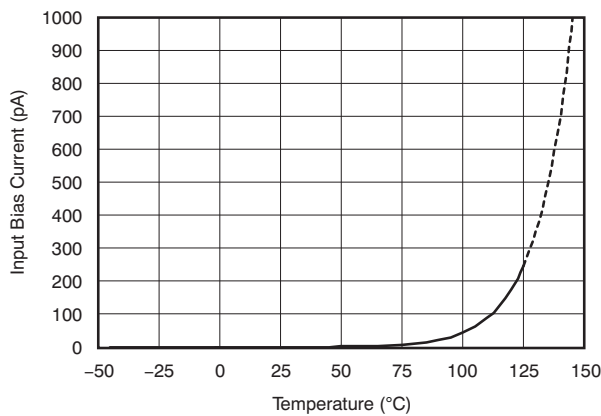

Figure 11.

**OUTPUT VOLTAGE vs OUTPUT CURRENT**

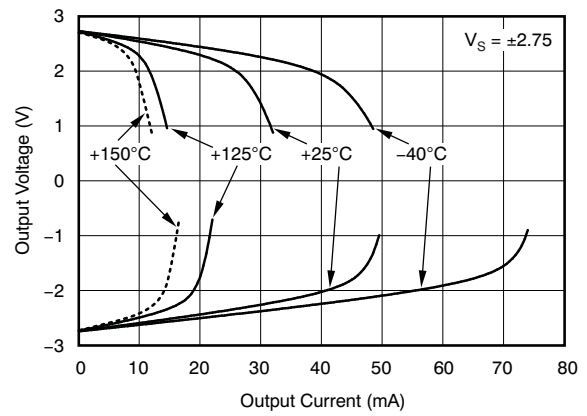

Figure 12.

**TYPICAL CHARACTERISTICS (continued)**

At  $T_A = +25^\circ\text{C}$ ,  $V_S = +5\text{V}$ ,  $R_L = 10\text{k}\Omega$  connected to  $V_S/2$ ,  $V_{CM} = V_S/2$ , and  $V_{OUT} = V_S/2$ , unless otherwise noted.

**OFFSET VOLTAGE PRODUCTION DISTRIBUTION**

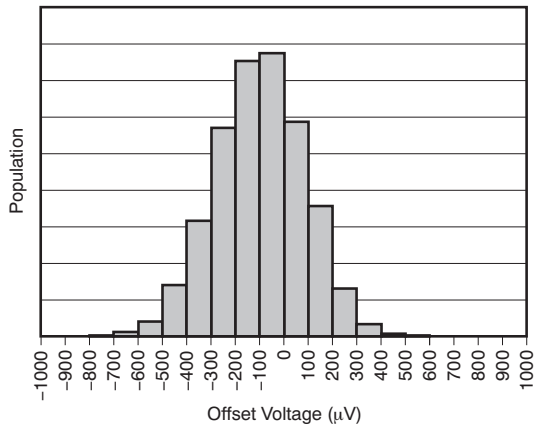

Figure 13.

**MAXIMUM OUTPUT VOLTAGE vs FREQUENCY**

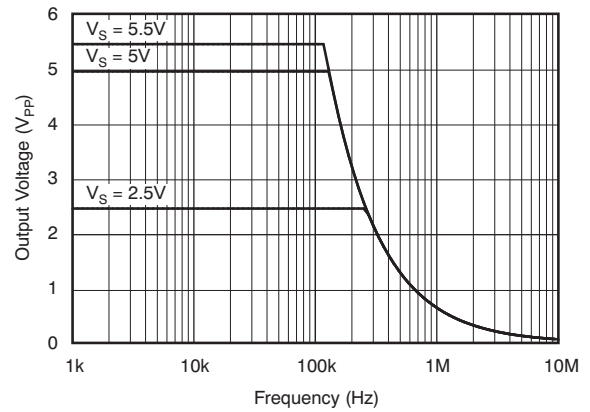

Figure 14.

**SMALL-SIGNAL OVERSHOOT vs LOAD CAPACITANCE**

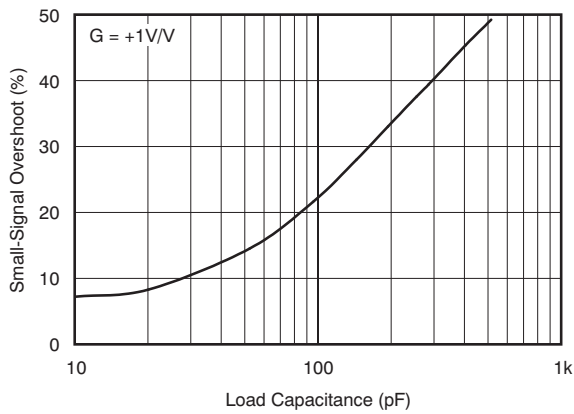

Figure 15.

**SMALL-SIGNAL PULSE RESPONSE**

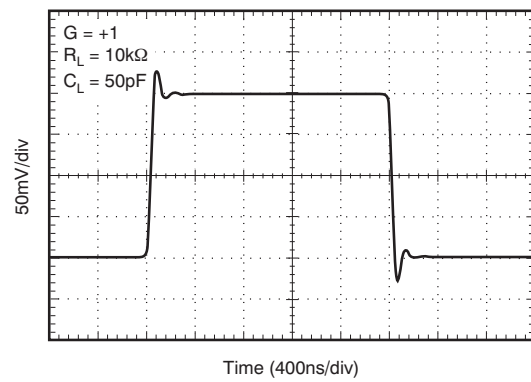

Figure 16.

**LARGE-SIGNAL PULSE RESPONSE**

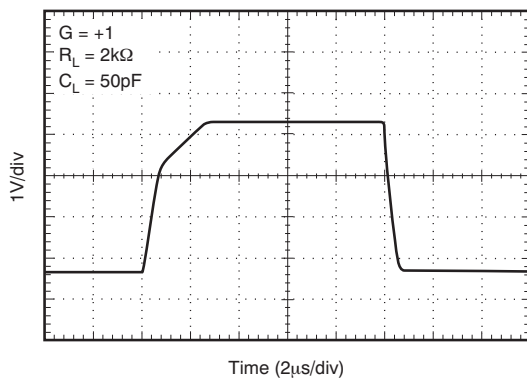

Figure 17.

**SETTLING TIME vs CLOSED-LOOP GAIN**

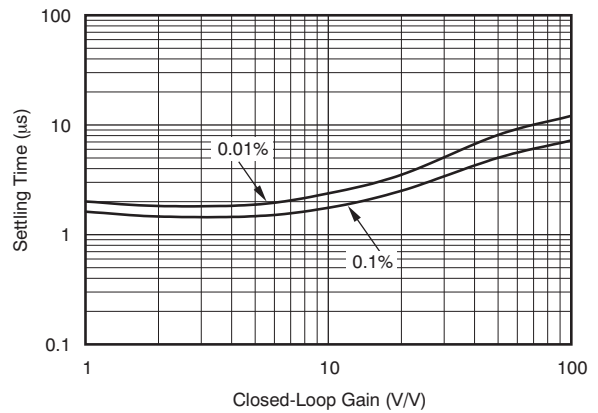

Figure 18.

**TYPICAL CHARACTERISTICS (continued)**

At  $T_A = +25^\circ\text{C}$ ,  $V_S = +5\text{V}$ ,  $R_L = 10\text{k}\Omega$  connected to  $V_S/2$ ,  $V_{CM} = V_S/2$ , and  $V_{OUT} = V_S/2$ , unless otherwise noted.



Figure 19.



Figure 20.



## APPLICATION INFORMATION

### OPERATING CHARACTERISTICS

The OPA377 family of amplifiers has parameters that are fully specified from 2.2V to 5.5V ( $\pm 1.1V$  to  $\pm 2.75V$ ). Many of the specifications apply from  $-40^{\circ}\text{C}$  to  $+125^{\circ}\text{C}$ . Parameters that can exhibit significant variance with regard to operating voltage or temperature are presented in the [Typical Characteristics](#).

### GENERAL LAYOUT GUIDELINES

For best operational performance of the device, good printed circuit board (PCB) layout practices are required. Low-loss,  $0.1\mu\text{F}$  bypass capacitors must be connected between each supply pin and ground, placed as close to the device as possible. A single bypass capacitor from  $V+$  to ground is applicable to single-supply applications.

### BASIC AMPLIFIER CONFIGURATIONS

The OPA377 family is unity-gain stable. It does not exhibit output phase inversion when the input is overdriven. A typical single-supply connection is shown in [Figure 21](#). The OPA377 is configured as a basic inverting amplifier with a gain of  $-10V/V$ . This single-supply connection has an output centered on the common-mode voltage,  $V_{\text{CM}}$ . For the circuit shown, this voltage is 2.5V, but may be any value within the common-mode input voltage range.

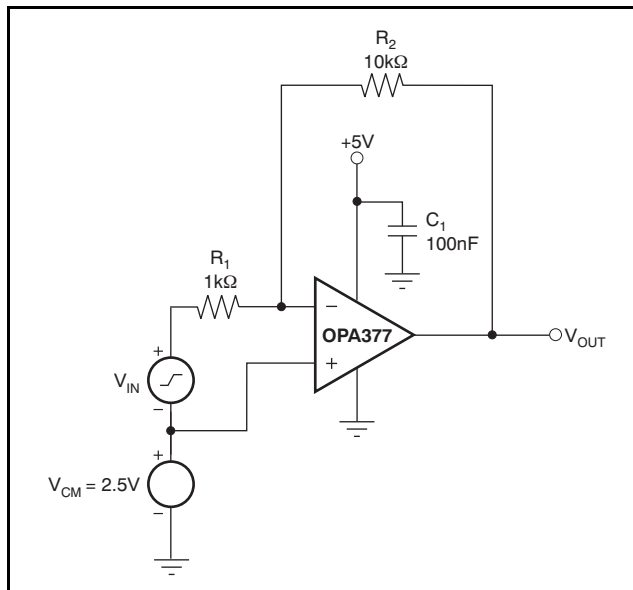

Figure 21. Basic Single-Supply Connection

### COMMON-MODE VOLTAGE RANGE

The input common-mode voltage range of the OPA377 series extends 100mV beyond the supply rails. The offset voltage of the amplifier is low, from approximately  $(V-)$  to  $(V+) - 1V$ , as shown in [Figure 22](#). The offset voltage increases as common-mode voltage exceeds  $(V+) - 1V$ . Common-mode rejection is specified from  $(V-)$  to  $(V+) - 1.3V$ .

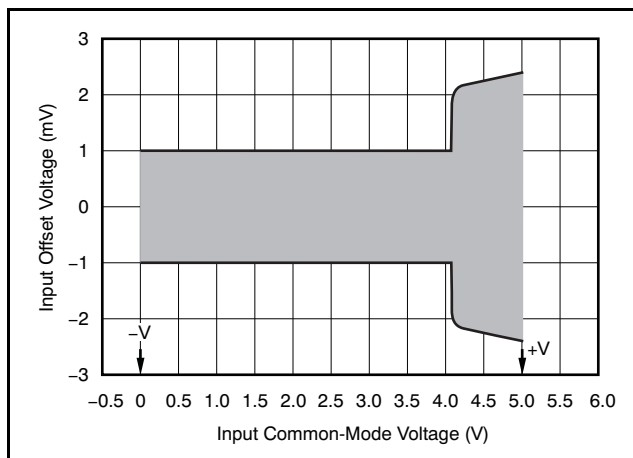
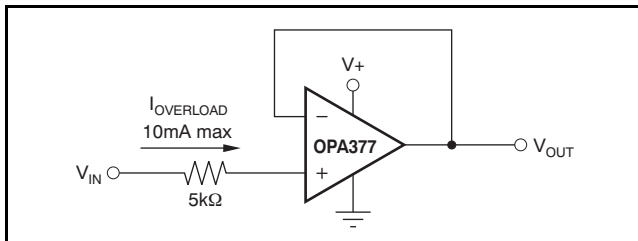

Figure 22. Offset and Common-Mode Voltage

## INPUT AND ESD PROTECTION

The OPA377 family incorporates internal electrostatic discharge (ESD) protection circuits on all pins. In the case of input and output pins, this protection primarily consists of current steering diodes connected between the input and power-supply pins. These ESD protection diodes also provide in-circuit, input overdrive protection, as long as the current is limited to 10mA as stated in the [Absolute Maximum Ratings](#). [Figure 23](#) shows how a series input resistor may be added to the driven input to limit the input current. The added resistor contributes thermal noise at the amplifier input and its value should be kept to a minimum in noise-sensitive applications.



**Figure 23. Input Current Protection**

## EMI SUSCEPTIBILITY AND INPUT FILTERING

Operational amplifiers vary in susceptibility to electromagnetic interference (EMI). If conducted EMI enters the operational amplifier, the dc offset observed at the amplifier output may shift from the nominal value while the EMI is present. This shift is a result of signal rectification associated with the internal semiconductor junctions. While all amplifier pin functions can be affected by EMI, the input pins are likely to be the most susceptible. The OPA377 operational amplifier family incorporates an internal input low-pass filter that reduces the amplifier response to EMI. Both common-mode and differential mode filtering are provided by the input filter. The filter is designed for a cutoff frequency of approximately 75MHz (–3dB), with a roll-off of 20dB per decade.

## CAPACITIVE LOAD AND STABILITY

The OPA377 series of amplifiers may be used in applications where driving a capacitive load is required. As with all op amps, there may be specific instances where the OPAx377 can become unstable, leading to oscillation. The particular op amp circuit configuration, layout, gain, and output loading are some of the factors to consider when establishing whether an amplifier will be stable in operation. An op amp in the unity-gain (+1V/V) buffer configuration and driving a capacitive load exhibits a greater tendency to be unstable than an amplifier operated at a higher noise gain. The capacitive load, in conjunction with the op amp output resistance, creates a pole within the feedback loop that degrades the phase margin. The degradation of the phase margin increases as the capacitive loading increases.

The OPAx377 in a unity-gain configuration can directly drive up to 250pF pure capacitive load. Increasing the gain enhances the ability of the amplifier to drive greater capacitive loads; see the typical characteristic plot, [Small-Signal Overshoot vs Capacitive Load](#). In unity-gain configurations, capacitive load drive can be improved by inserting a small (10Ω to 20Ω) resistor,  $R_S$ , in series with the output, as shown in [Figure 24](#). This resistor significantly reduces ringing while maintaining dc performance for purely capacitive loads. However, if there is a resistive load in parallel with the capacitive load, a voltage divider is created, introducing a gain error at the output and slightly reducing the output swing. The error introduced is proportional to the ratio  $R_S/R_L$ , and is generally negligible at low output current levels.

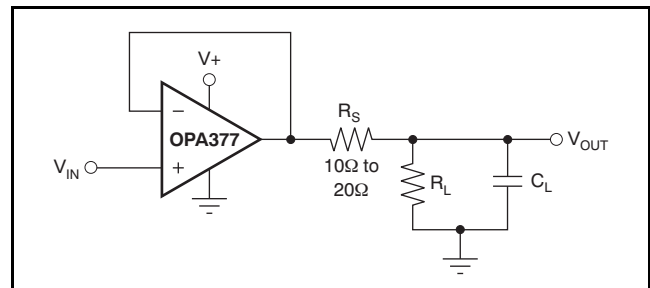

**Figure 24. Improving Capacitive Load Drive**

## ACTIVE FILTERING

The OPA377 series is well-suited for filter applications requiring a wide bandwidth, fast slew rate, low-noise, single-supply operational amplifier. Figure 25 shows a 50kHz, 2nd-order, low-pass filter. The components have been selected to provide a maximally-flat Butterworth response. Beyond the cutoff frequency, roll-off is  $-40\text{dB/dec}$ . The Butterworth response is ideal for applications requiring predictable gain characteristics such as the anti-aliasing filter used ahead of an analog-to-digital converter (ADC).

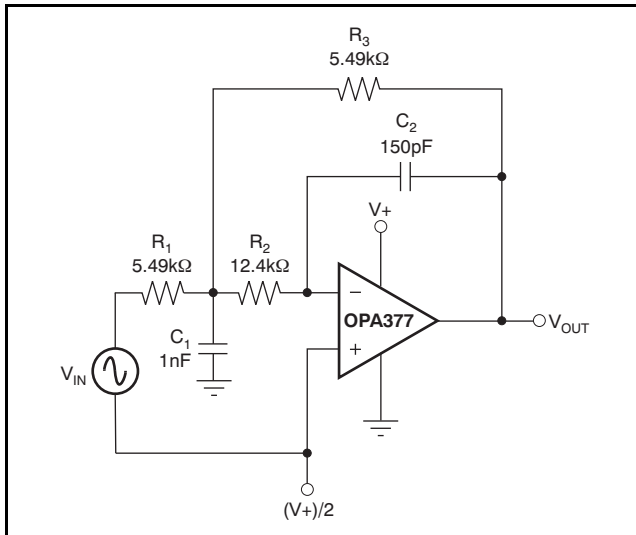
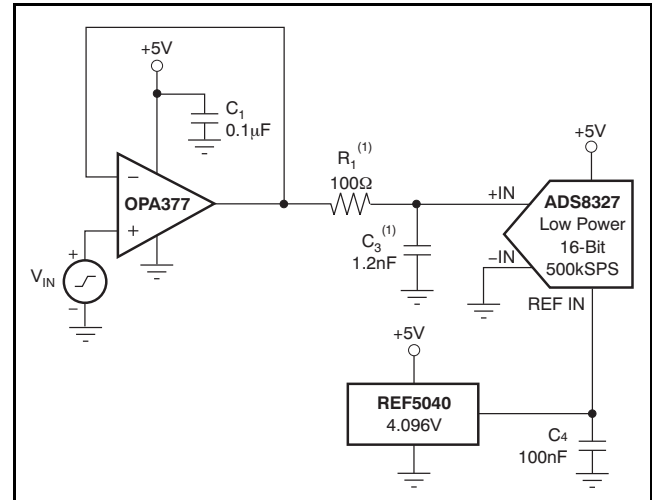

Figure 25. Second-Order Butterworth 50kHz Low-Pass Filter

## DRIVING AN ANALOG-TO-DIGITAL CONVERTER

The low noise and wide gain bandwidth of the OPA377 family make it an ideal driver for ADCs. Figure 26 illustrates the OPA377 driving an ADS8327, 16-bit, 250kSPS converter. The amplifier is connected as a unity-gain, noninverting buffer.



(1) Suggested value; may require adjustment based on specific application.

(2) Initial calibration recommended.

Figure 26. Driving an ADS8327<sup>(2)</sup>

## REVISION HISTORY

NOTE: Page numbers for previous revisions may differ from page numbers in the current version.

Changes from Revision A (October 2010) to Revision B	Page
• Changed document status to production data .....	1
• Deleted cross-reference to note 2 and shading from DCK package in Package Information table .....	2
• Updated <a href="#">Figure 22</a> .....	9

Changes from Original (February 2010) to Revision A	Page
• Deleted DFN from list of packages in final <i>Features</i> bullet .....	1
• Deleted DFN package from <i>Description</i> section .....	1
• Updated <i>Input Bias Current vs Temperature</i> plot .....	1
• Deleted cross-reference to note 2 and shading from all packages except SC70-5 in Package Information table .....	2
• Deleted DFN-8 package from Package Information table .....	2
• Deleted Temperature Range, <i>DFN-8</i> parameter from Electrical Characteristics table .....	3
• Deleted DFN-8 pin configuration .....	4
• Updated <a href="#">Figure 11</a> .....	6

**PACKAGING INFORMATION**

Orderable Device	Status (1)	Package Type	Package Drawing	Pins	Package Qty	Eco Plan (2)	Lead/Ball Finish (6)	MSL Peak Temp (3)	Op Temp (°C)	Device Marking (4/5)	Samples
OPA2377AID	ACTIVE	SOIC	D	8	75	Green (RoHS & no Sb/Br)	CU NIPDAU	Level-2-260C-1 YEAR	-40 to 125	O2377A	<a href="#">Samples</a>
OPA2377AIDGKR	ACTIVE	VSSOP	DGK	8	2500	Green (RoHS & no Sb/Br)	CU NIPDAU   CU NIPDAUAG	Level-2-260C-1 YEAR	-40 to 125	OTAQ	<a href="#">Samples</a>
OPA2377AIDGKT	ACTIVE	VSSOP	DGK	8	250	Green (RoHS & no Sb/Br)	CU NIPDAU   CU NIPDAUAG	Level-2-260C-1 YEAR	-40 to 125	OTAQ	<a href="#">Samples</a>
OPA2377AIDR	ACTIVE	SOIC	D	8	2500	Green (RoHS & no Sb/Br)	CU NIPDAU	Level-2-260C-1 YEAR	-40 to 125	O2377A	<a href="#">Samples</a>
OPA377AID	ACTIVE	SOIC	D	8	75	Green (RoHS & no Sb/Br)	CU NIPDAU	Level-2-260C-1 YEAR	-40 to 125	OP377A	<a href="#">Samples</a>
OPA377AIDBVR	ACTIVE	SOT-23	DBV	5	3000	Green (RoHS & no Sb/Br)	CU NIPDAU	Level-2-260C-1 YEAR	-40 to 125	PAG	<a href="#">Samples</a>
OPA377AIDBVT	ACTIVE	SOT-23	DBV	5	250	Green (RoHS & no Sb/Br)	CU NIPDAU	Level-2-260C-1 YEAR	-40 to 125	PAG	<a href="#">Samples</a>
OPA377AIDCKR	ACTIVE	SC70	DCK	5	3000	Green (RoHS & no Sb/Br)	CU NIPDAU	Level-2-260C-1 YEAR	-40 to 125	PAF	<a href="#">Samples</a>
OPA377AIDCKT	ACTIVE	SC70	DCK	5	250	Green (RoHS & no Sb/Br)	CU NIPDAU	Level-2-260C-1 YEAR	-40 to 125	PAF	<a href="#">Samples</a>
OPA377AIDR	ACTIVE	SOIC	D	8	2500	Green (RoHS & no Sb/Br)	CU NIPDAU	Level-2-260C-1 YEAR	-40 to 125	OP377A	<a href="#">Samples</a>
OPA4377AIPW	ACTIVE	TSSOP	PW	14	90	Green (RoHS & no Sb/Br)	CU NIPDAU	Level-2-260C-1 YEAR	-40 to 125	OP4377A	<a href="#">Samples</a>
OPA4377AIPWR	ACTIVE	TSSOP	PW	14	2000	Green (RoHS & no Sb/Br)	CU NIPDAU	Level-2-260C-1 YEAR	-40 to 125	OP4377A	<a href="#">Samples</a>

(1) The marketing status values are defined as follows:

**ACTIVE:** Product device recommended for new designs.

**LIFEBUY:** TI has announced that the device will be discontinued, and a lifetime-buy period is in effect.

**NRND:** Not recommended for new designs. Device is in production to support existing customers, but TI does not recommend using this part in a new design.

**PREVIEW:** Device has been announced but is not in production. Samples may or may not be available.

**OBSELETE:** TI has discontinued the production of the device.

(2) Eco Plan - The planned eco-friendly classification: Pb-Free (RoHS), Pb-Free (RoHS Exempt), or Green (RoHS & no Sb/Br) - please check <http://www.ti.com/productcontent> for the latest availability information and additional product content details.

**TBD:** The Pb-Free/Green conversion plan has not been defined.

---

**Pb-Free (RoHS):** TI's terms "Lead-Free" or "Pb-Free" mean semiconductor products that are compatible with the current RoHS requirements for all 6 substances, including the requirement that lead not exceed 0.1% by weight in homogeneous materials. Where designed to be soldered at high temperatures, TI Pb-Free products are suitable for use in specified lead-free processes.

**Pb-Free (RoHS Exempt):** This component has a RoHS exemption for either 1) lead-based flip-chip solder bumps used between the die and package, or 2) lead-based die adhesive used between the die and leadframe. The component is otherwise considered Pb-Free (RoHS compatible) as defined above.

**Green (RoHS & no Sb/Br):** TI defines "Green" to mean Pb-Free (RoHS compatible), and free of Bromine (Br) and Antimony (Sb) based flame retardants (Br or Sb do not exceed 0.1% by weight in homogeneous material)

<sup>(3)</sup> MSL, Peak Temp. - The Moisture Sensitivity Level rating according to the JEDEC industry standard classifications, and peak solder temperature.

<sup>(4)</sup> There may be additional marking, which relates to the logo, the lot trace code information, or the environmental category on the device.

<sup>(5)</sup> Multiple Device Markings will be inside parentheses. Only one Device Marking contained in parentheses and separated by a "~" will appear on a device. If a line is indented then it is a continuation of the previous line and the two combined represent the entire Device Marking for that device.

<sup>(6)</sup> Lead/Ball Finish - Orderable Devices may have multiple material finish options. Finish options are separated by a vertical ruled line. Lead/Ball Finish values may wrap to two lines if the finish value exceeds the maximum column width.

**Important Information and Disclaimer:**The information provided on this page represents TI's knowledge and belief as of the date that it is provided. TI bases its knowledge and belief on information provided by third parties, and makes no representation or warranty as to the accuracy of such information. Efforts are underway to better integrate information from third parties. TI has taken and continues to take reasonable steps to provide representative and accurate information but may not have conducted destructive testing or chemical analysis on incoming materials and chemicals. TI and TI suppliers consider certain information to be proprietary, and thus CAS numbers and other limited information may not be available for release.

In no event shall TI's liability arising out of such information exceed the total purchase price of the TI part(s) at issue in this document sold by TI to Customer on an annual basis.

## TAPE AND REEL INFORMATION



### QUADRANT ASSIGNMENTS FOR PIN 1 ORIENTATION IN TAPE



\*All dimensions are nominal

Device	Package Type	Package Drawing	Pins	SPQ	Reel Diameter (mm)	Reel Width W1 (mm)	A0 (mm)	B0 (mm)	K0 (mm)	P1 (mm)	W (mm)	Pin1 Quadrant
OPA2377AIDGKR	VSSOP	DGK	8	2500	330.0	12.4	5.3	3.4	1.4	8.0	12.0	Q1
OPA2377AIDGKT	VSSOP	DGK	8	250	330.0	12.4	5.3	3.4	1.4	8.0	12.0	Q1
OPA2377AIDR	SOIC	D	8	2500	330.0	12.4	6.4	5.2	2.1	8.0	12.0	Q1
OPA377AIDBVR	SOT-23	DBV	5	3000	180.0	8.4	3.23	3.17	1.37	4.0	8.0	Q3
OPA377AIDBVT	SOT-23	DBV	5	250	179.0	8.4	3.2	3.2	1.4	4.0	8.0	Q3
OPA377AIDCKR	SC70	DCK	5	3000	179.0	8.4	2.2	2.5	1.2	4.0	8.0	Q3
OPA377AIDCKT	SC70	DCK	5	250	179.0	8.4	2.2	2.5	1.2	4.0	8.0	Q3
OPA377AIDR	SOIC	D	8	2500	330.0	12.4	6.4	5.2	2.1	8.0	12.0	Q1
OPA4377AIPWR	TSSOP	PW	14	2000	330.0	12.4	6.9	5.6	1.6	8.0	12.0	Q1

**TAPE AND REEL BOX DIMENSIONS**

\*All dimensions are nominal

Device	Package Type	Package Drawing	Pins	SPQ	Length (mm)	Width (mm)	Height (mm)
OPA2377AIDGKR	VSSOP	DGK	8	2500	366.0	364.0	50.0
OPA2377AIDGKT	VSSOP	DGK	8	250	366.0	364.0	50.0
OPA2377AIDR	SOIC	D	8	2500	367.0	367.0	35.0
OPA377AIDBVR	SOT-23	DBV	5	3000	223.0	270.0	35.0
OPA377AIDBVR	SOT-23	DBV	5	3000	195.0	200.0	45.0
OPA377AIDBVT	SOT-23	DBV	5	250	195.0	200.0	45.0
OPA377AIDBVT	SOT-23	DBV	5	250	223.0	270.0	35.0
OPA377AIDCKR	SC70	DCK	5	3000	195.0	200.0	45.0
OPA377AIDCKT	SC70	DCK	5	250	195.0	200.0	45.0
OPA377AIDR	SOIC	D	8	2500	367.0	367.0	35.0
OPA4377AIPWR	TSSOP	PW	14	2000	367.0	367.0	35.0



DBV (R-PDSO-G5)

PLASTIC SMALL-OUTLINE PACKAGE



- NOTES:
- A. All linear dimensions are in millimeters.
  - B. This drawing is subject to change without notice.
  - C. Body dimensions do not include mold flash or protrusion. Mold flash and protrusion shall not exceed 0.15 per side.
  - D. Falls within JEDEC MO-178 Variation AA.

DBV (R-PDSO-G5)

PLASTIC SMALL OUTLINE



- NOTES:
- A. All linear dimensions are in millimeters.
  - B. This drawing is subject to change without notice.
  - C. Customers should place a note on the circuit board fabrication drawing not to alter the center solder mask defined pad.
  - D. Publication IPC-7351 is recommended for alternate designs.
  - E. Laser cutting apertures with trapezoidal walls and also rounding corners will offer better paste release. Customers should contact their board assembly site for stencil design recommendations. Example stencil design based on a 50% volumetric metal load solder paste. Refer to IPC-7525 for other stencil recommendations.

DCK (R-PDSO-G5)

PLASTIC SMALL-OUTLINE PACKAGE



- NOTES:
- A. All linear dimensions are in millimeters.
  - B. This drawing is subject to change without notice.
  - C. Body dimensions do not include mold flash or protrusion. Mold flash and protrusion shall not exceed 0.15 per side.
  - D. Falls within JEDEC MO-203 variation AA.

DCK (R-PDSO-G5)

PLASTIC SMALL OUTLINE



- NOTES:
- A. All linear dimensions are in millimeters.
  - B. This drawing is subject to change without notice.
  - C. Customers should place a note on the circuit board fabrication drawing not to alter the center solder mask defined pad.
  - D. Publication IPC-7351 is recommended for alternate designs.
  - E. Laser cutting apertures with trapezoidal walls and also rounding corners will offer better paste release. Customers should contact their board assembly site for stencil design recommendations. Example stencil design based on a 50% volumetric metal load solder paste. Refer to IPC-7525 for other stencil recommendations.





- NOTES:
- A. All linear dimensions are in millimeters.
  - B. This drawing is subject to change without notice.
  - C. Publication IPC-7351 is recommended for alternate designs.
  - D. Laser cutting apertures with trapezoidal walls and also rounding corners will offer better paste release. Customers should contact their board assembly site for stencil design recommendations. Refer to IPC-7525 for other stencil recommendations.
  - E. Customers should contact their board fabrication site for solder mask tolerances between and around signal pads.

PW (R-PDSO-G14)

PLASTIC SMALL OUTLINE



- NOTES:
- A. All linear dimensions are in millimeters. Dimensioning and tolerancing per ASME Y14.5M-1994.
  - B. This drawing is subject to change without notice.
  - C. Body length does not include mold flash, protrusions, or gate burrs. Mold flash, protrusions, or gate burrs shall not exceed 0,15 each side.
  - D. Body width does not include interlead flash. Interlead flash shall not exceed 0,25 each side.
  - E. Falls within JEDEC MO-153

PW (R-PDSO-G14)

PLASTIC SMALL OUTLINE



4211284-2/G 08/15

- NOTES:
- A. All linear dimensions are in millimeters.
  - B. This drawing is subject to change without notice.
  - C. Publication IPC-7351 is recommended for alternate designs.
  - D. Laser cutting apertures with trapezoidal walls and also rounding corners will offer better paste release. Customers should contact their board assembly site for stencil design recommendations. Refer to IPC-7525 for other stencil recommendations.
  - E. Customers should contact their board fabrication site for solder mask tolerances between and around signal pads.



D (R-PDSO-G8)

PLASTIC SMALL OUTLINE



NOTES: A. All linear dimensions are in inches (millimeters).  
 B. This drawing is subject to change without notice.  
 C. Body length does not include mold flash, protrusions, or gate burrs. Mold flash, protrusions, or gate burrs shall not exceed 0.006 (0,15) each side.  
 D. Body width does not include interlead flash. Interlead flash shall not exceed 0.017 (0,43) each side.  
 E. Reference JEDEC MS-012 variation AA.

D (R-PDSO-G8)

PLASTIC SMALL OUTLINE



- NOTES:
- All linear dimensions are in millimeters.
  - This drawing is subject to change without notice.
  - Publication IPC-7351 is recommended for alternate designs.
  - Laser cutting apertures with trapezoidal walls and also rounding corners will offer better paste release. Customers should contact their board assembly site for stencil design recommendations. Refer to IPC-7525 for other stencil recommendations.
  - Customers should contact their board fabrication site for solder mask tolerances between and around signal pads.

## IMPORTANT NOTICE

Texas Instruments Incorporated and its subsidiaries (TI) reserve the right to make corrections, enhancements, improvements and other changes to its semiconductor products and services per JESD46, latest issue, and to discontinue any product or service per JESD48, latest issue. Buyers should obtain the latest relevant information before placing orders and should verify that such information is current and complete. All semiconductor products (also referred to herein as "components") are sold subject to TI's terms and conditions of sale supplied at the time of order acknowledgment.

TI warrants performance of its components to the specifications applicable at the time of sale, in accordance with the warranty in TI's terms and conditions of sale of semiconductor products. Testing and other quality control techniques are used to the extent TI deems necessary to support this warranty. Except where mandated by applicable law, testing of all parameters of each component is not necessarily performed.

TI assumes no liability for applications assistance or the design of Buyers' products. Buyers are responsible for their products and applications using TI components. To minimize the risks associated with Buyers' products and applications, Buyers should provide adequate design and operating safeguards.

TI does not warrant or represent that any license, either express or implied, is granted under any patent right, copyright, mask work right, or other intellectual property right relating to any combination, machine, or process in which TI components or services are used. Information published by TI regarding third-party products or services does not constitute a license to use such products or services or a warranty or endorsement thereof. Use of such information may require a license from a third party under the patents or other intellectual property of the third party, or a license from TI under the patents or other intellectual property of TI.

Reproduction of significant portions of TI information in TI data books or data sheets is permissible only if reproduction is without alteration and is accompanied by all associated warranties, conditions, limitations, and notices. TI is not responsible or liable for such altered documentation. Information of third parties may be subject to additional restrictions.

Resale of TI components or services with statements different from or beyond the parameters stated by TI for that component or service voids all express and any implied warranties for the associated TI component or service and is an unfair and deceptive business practice. TI is not responsible or liable for any such statements.

Buyer acknowledges and agrees that it is solely responsible for compliance with all legal, regulatory and safety-related requirements concerning its products, and any use of TI components in its applications, notwithstanding any applications-related information or support that may be provided by TI. Buyer represents and agrees that it has all the necessary expertise to create and implement safeguards which anticipate dangerous consequences of failures, monitor failures and their consequences, lessen the likelihood of failures that might cause harm and take appropriate remedial actions. Buyer will fully indemnify TI and its representatives against any damages arising out of the use of any TI components in safety-critical applications.

In some cases, TI components may be promoted specifically to facilitate safety-related applications. With such components, TI's goal is to help enable customers to design and create their own end-product solutions that meet applicable functional safety standards and requirements. Nonetheless, such components are subject to these terms.

No TI components are authorized for use in FDA Class III (or similar life-critical medical equipment) unless authorized officers of the parties have executed a special agreement specifically governing such use.

Only those TI components which TI has specifically designated as military grade or "enhanced plastic" are designed and intended for use in military/aerospace applications or environments. Buyer acknowledges and agrees that any military or aerospace use of TI components which have **not** been so designated is solely at the Buyer's risk, and that Buyer is solely responsible for compliance with all legal and regulatory requirements in connection with such use.

TI has specifically designated certain components as meeting ISO/TS16949 requirements, mainly for automotive use. In any case of use of non-designated products, TI will not be responsible for any failure to meet ISO/TS16949.

### Products

Audio	<a href="http://www.ti.com/audio">www.ti.com/audio</a>
Amplifiers	<a href="http://amplifier.ti.com">amplifier.ti.com</a>
Data Converters	<a href="http://dataconverter.ti.com">dataconverter.ti.com</a>
DLP® Products	<a href="http://www.dlp.com">www.dlp.com</a>
DSP	<a href="http://dsp.ti.com">dsp.ti.com</a>
Clocks and Timers	<a href="http://www.ti.com/clocks">www.ti.com/clocks</a>
Interface	<a href="http://interface.ti.com">interface.ti.com</a>
Logic	<a href="http://logic.ti.com">logic.ti.com</a>
Power Mgmt	<a href="http://power.ti.com">power.ti.com</a>
Microcontrollers	<a href="http://microcontroller.ti.com">microcontroller.ti.com</a>
RFID	<a href="http://www.ti-rfid.com">www.ti-rfid.com</a>
OMAP Applications Processors	<a href="http://www.ti.com/omap">www.ti.com/omap</a>
Wireless Connectivity	<a href="http://www.ti.com/wirelessconnectivity">www.ti.com/wirelessconnectivity</a>

### Applications

Automotive and Transportation	<a href="http://www.ti.com/automotive">www.ti.com/automotive</a>
Communications and Telecom	<a href="http://www.ti.com/communications">www.ti.com/communications</a>
Computers and Peripherals	<a href="http://www.ti.com/computers">www.ti.com/computers</a>
Consumer Electronics	<a href="http://www.ti.com/consumer-apps">www.ti.com/consumer-apps</a>
Energy and Lighting	<a href="http://www.ti.com/energy">www.ti.com/energy</a>
Industrial	<a href="http://www.ti.com/industrial">www.ti.com/industrial</a>
Medical	<a href="http://www.ti.com/medical">www.ti.com/medical</a>
Security	<a href="http://www.ti.com/security">www.ti.com/security</a>
Space, Avionics and Defense	<a href="http://www.ti.com/space-avionics-defense">www.ti.com/space-avionics-defense</a>
Video and Imaging	<a href="http://www.ti.com/video">www.ti.com/video</a>

### TI E2E Community

[e2e.ti.com](http://e2e.ti.com)