

0.03- $\mu\text{V}/^\circ\text{C}$ Drift, Low-Noise, Rail-to-Rail Output, 36-V, Zero-Drift OPERATIONAL AMPLIFIERS

Check for Samples: [OPA2188](#)

FEATURES

- **Low Offset Voltage:** 25 μV (max)
- **Zero-Drift:** 0.03 $\mu\text{V}/^\circ\text{C}$
- **Low Noise:** 8.8 $\text{nV}/\sqrt{\text{Hz}}$
0.1-Hz to 10-Hz Noise: 0.25 μV_{PP}
- **Excellent DC Precision:**
PSRR: 142 dB
CMRR: 146 dB
Open-Loop Gain: 136 dB
- **Gain Bandwidth:** 2 MHz
- **Quiescent Current:** 475 μA (max)
- **Wide Supply Range:** $\pm 2\text{ V}$ to $\pm 18\text{ V}$
- **Rail-to-Rail Output:**
Input Includes Negative Rail
- **RFI Filtered Inputs**
- **MicroSIZE Packages**

APPLICATIONS

- **Bridge Amplifiers**
- **Strain Gauges**
- **Test Equipment**
- **Transducer Applications**
- **Temperature Measurement**
- **Electronic Scales**
- **Medical Instrumentation**
- **Resistance Temperature Detectors**
- **Precision Active Filters**

DESCRIPTION

The OPA2188 operational amplifier uses TI proprietary auto-zeroing techniques to provide low offset voltage (25 μV , max), and near zero-drift over time and temperature. This miniature, high-precision, low quiescent current amplifier offers high input impedance and rail-to-rail output swing within 15 mV of the rails. The input common-mode range includes the negative rail. Either single or dual supplies can be used in the range of +4.0 V to +36 V ($\pm 2\text{ V}$ to $\pm 18\text{ V}$).

The OPA2188 is available in MSOP-8 and SO-8 packages. The device is specified for operation from -40°C to $+105^\circ\text{C}$.

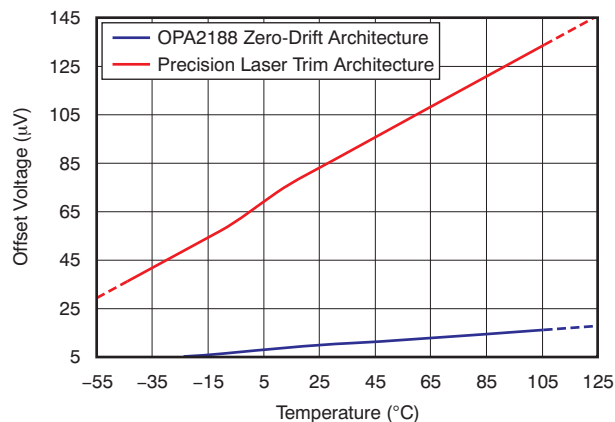

Zero-Drift Amplifier Portfolio

VERSION	PRODUCT	OFFSET VOLTAGE (μV)	OFFSET VOLTAGE DRIFT ($\mu\text{V}/^\circ\text{C}$)	BANDWIDTH (MHz)
Single	OPA188 (4 V to 36 V)	25	0.085	2
	OPA333 (5 V)	10	0.05	0.35
	OPA378 (5 V)	50	0.25	0.9
	OPA735 (12 V)	5	0.05	1.6
Dual	OPA2188 (4 V to 36 V)	25	0.085	2
	OPA2333 (5 V)	10	0.05	0.35
	OPA2378 (5 V)	50	0.25	0.9
	OPA2735 (12 V)	5	0.05	1.6
Quad	OPA4188 (4 V to 36 V)	25	0.085	2
	OPA4330 (5 V)	50	0.25	0.35



Please be aware that an important notice concerning availability, standard warranty, and use in critical applications of Texas Instruments semiconductor products and disclaimers thereto appears at the end of this data sheet.

All trademarks are the property of their respective owners.



This integrated circuit can be damaged by ESD. Texas Instruments recommends that all integrated circuits be handled with appropriate precautions. Failure to observe proper handling and installation procedures can cause damage.

ESD damage can range from subtle performance degradation to complete device failure. Precision integrated circuits may be more susceptible to damage because very small parametric changes could cause the device not to meet its published specifications.

PACKAGE INFORMATION⁽¹⁾

PRODUCT	PACKAGE-LEAD	PACKAGE DESIGNATOR	SPECIFIED TEMPERATURE RANGE	PACKAGE MARKING	ORDERING NUMBER	TRANSPORT MEDIA, QUANTITY
OPA2188	SO-8	D	–40°C to +105°C	2188	OPA2188AID	Rails, 100
					OPA2188AIDR	Tape and Reel, 2500
	MSOP-8	DGK	–40°C to +105°C	2188	OPA2188AIDGKT	Tape and Reel, 250
					OPA2188AIDGKR	Tape and Reel, 2500

(1) For the most current package and ordering information, see the Package Option Addendum at the end of this document, or visit the device product folder at www.ti.com.

ABSOLUTE MAXIMUM RATINGS⁽¹⁾

		VALUE	UNIT
Supply voltage		±20, 40 (single supply)	V
Signal input terminals ⁽²⁾	Voltage	(V–) – 0.5 to (V+) + 0.5	V
	Current	±10	mA
Output short-circuit ⁽³⁾		Continuous	
Temperature range	Operating, T _A	–55 to +125	°C
	Storage, T _{stg}	–65 to +150	°C
	Junction, T _J	+150	°C
Electrostatic discharge (ESD) ratings	Human body model (HBM)	1.5	kV
	Charged device model (CDM)	1	kV

- (1) Stresses above these ratings may cause permanent damage. Exposure to absolute maximum conditions for extended periods may degrade device reliability. These are stress ratings only and functional operation of the device at these or any other conditions beyond those specified is not implied.
- (2) Input terminals are diode-clamped to the power-supply rails. Input signals that can swing more than 0.5 V beyond the supply rails should be current-limited to 10 mA or less.
- (3) Short-circuit to ground, one amplifier per package.

**ELECTRICAL CHARACTERISTICS:
High-Voltage Operation, $V_S = \pm 4\text{ V}$ to $\pm 18\text{ V}$ ($V_S = +8\text{ V}$ to $+36\text{ V}$)**

 At $T_A = +25^\circ\text{C}$, $R_L = 10\text{ k}\Omega$ connected to $V_S / 2$, and $V_{\text{COM}} = V_{\text{OUT}} = V_S / 2$, unless otherwise noted.

PARAMETER	CONDITIONS	OPA2188			UNIT
		MIN	TYP	MAX	
OFFSET VOLTAGE					
V_{OS}	Input offset voltage		6	25	μV
		$T_A = -40^\circ\text{C}$ to $+105^\circ\text{C}$	0.03	0.085	$\mu\text{V}/^\circ\text{C}$
PSRR	Power-supply rejection ratio	$V_S = 4\text{ V}$ to 36 V , $V_{\text{CM}} = V_S / 2$	0.075	0.3	$\mu\text{V}/\text{V}$
		$V_S = 4\text{ V}$ to 36 V , $V_{\text{CM}} = V_S / 2$, $T_A = -40^\circ\text{C}$ to $+105^\circ\text{C}$		0.3	$\mu\text{V}/\text{V}$
	Long-term stability		4 ⁽¹⁾		μV
	Channel separation, dc		1		$\mu\text{V}/\text{V}$
INPUT BIAS CURRENT					
I_B	Input bias current	$V_{\text{CM}} = V_S / 2$	± 160	± 850	pA
		$T_A = -40^\circ\text{C}$ to $+105^\circ\text{C}$		± 4	nA
I_{OS}	Input offset current		± 320	± 1700	pA
		$T_A = -40^\circ\text{C}$ to $+105^\circ\text{C}$		± 2	nA
NOISE					
e_n	Input voltage noise	$f = 0.1\text{ Hz}$ to 10 Hz	0.25		μV_{PP}
e_n	Input voltage noise density	$f = 1\text{ kHz}$	8.8		$\text{nV}/\sqrt{\text{Hz}}$
i_n	Input current noise density	$f = 1\text{ kHz}$	7		$\text{fA}/\sqrt{\text{Hz}}$
INPUT VOLTAGE RANGE					
V_{CM}	Common-mode voltage range		V^-	$(V^+) - 1.5$	V
CMRR	Common-mode rejection ratio	$(V^-) < V_{\text{CM}} < (V^+) - 1.5\text{ V}$	120	134	dB
		$(V^-) + 0.5\text{ V} < V_{\text{CM}} < (V^+) - 1.5\text{ V}$, $V_S = \pm 18\text{ V}$	130	146	dB
		$(V^-) + 0.5\text{ V} < V_{\text{CM}} < (V^+) - 1.5\text{ V}$, $V_S = \pm 18\text{ V}$, $T_A = -40^\circ\text{C}$ to $+105^\circ\text{C}$	120	126	dB
INPUT IMPEDANCE					
	Differential		100 6		$\text{M}\Omega$ pF
	Common-mode		6 9.5		$10^{12}\ \Omega$ pF
OPEN-LOOP GAIN					
A_{OL}	Open-loop voltage gain	$(V^-) + 500\text{ mV} < V_{\text{O}} < (V^+) - 500\text{ mV}$, $R_L = 10\text{ k}\Omega$	130	136	dB
		$(V^-) + 500\text{ mV} < V_{\text{O}} < (V^+) - 500\text{ mV}$, $R_L = 10\text{ k}\Omega$, $T_A = -40^\circ\text{C}$ to $+105^\circ\text{C}$	120	126	dB
FREQUENCY RESPONSE					
GBW	Gain-bandwidth product		2		MHz
SR	Slew rate	$G = +1$	0.8		$\text{V}/\mu\text{s}$
	Settling time, 0.1%	$V_S = \pm 18\text{ V}$, $G = 1$, 10-V step	20		μs
	Settling time, 0.01%	$V_S = \pm 18\text{ V}$, $G = 1$, 10-V step	27		μs
	Overload recovery time	$V_{\text{IN}} \times G = V_S$	1		μs
THD+N	Total harmonic distortion + noise	1 kHz, $G = 1$, $V_{\text{OUT}} = 1\text{ V}_{\text{RMS}}$	0.0001		%

 (1) 1000-hour life test at $+125^\circ\text{C}$ demonstrated randomly distributed variation in the range of measurement limits—approximately $4\ \mu\text{V}$.

ELECTRICAL CHARACTERISTICS:
High-Voltage Operation, $V_S = \pm 4\text{ V}$ to $\pm 18\text{ V}$ ($V_S = +8\text{ V}$ to $+36\text{ V}$) (continued)

 At $T_A = +25^\circ\text{C}$, $R_L = 10\text{ k}\Omega$ connected to $V_S / 2$, and $V_{\text{COM}} = V_{\text{OUT}} = V_S / 2$, unless otherwise noted.

PARAMETER		CONDITIONS	OPA2188			UNIT
			MIN	TYP	MAX	
OUTPUT						
Voltage output swing from rail		No load		6	15	mV
		$R_L = 10\text{ k}\Omega$		220	250	mV
		$R_L = 10\text{ k}\Omega$, $T_A = -40^\circ\text{C}$ to $+105^\circ\text{C}$		310	350	mV
I_{SC}	Short-circuit current			± 18		mA
R_O	Open-loop output resistance	$f = 1\text{ MHz}$, $I_O = 0$		120		Ω
C_{LOAD}	Capacitive load drive			1		nF
POWER SUPPLY						
V_S	Operating voltage range			4 to 36 (± 2 to ± 18)		V
I_Q	Quiescent current (per amplifier)	$V_S = \pm 4\text{ V}$ to $V_S = \pm 18\text{ V}$		415	475	μA
		$I_O = 0\text{ mA}$, $T_A = -40^\circ\text{C}$ to $+105^\circ\text{C}$			525	μA
TEMPERATURE RANGE						
Temperature range	Specified			-40	+105	$^\circ\text{C}$
	Operating			-40	+125	$^\circ\text{C}$
	Storage			-65	+150	$^\circ\text{C}$

**ELECTRICAL CHARACTERISTICS:
Low-Voltage Operation, $V_S = \pm 2\text{ V}$ to $< \pm 4\text{ V}$ ($V_S = +4\text{ V}$ to $< +8\text{ V}$)**

 At $T_A = +25^\circ\text{C}$, $R_L = 10\text{ k}\Omega$ connected to $V_S / 2$, and $V_{\text{COM}} = V_{\text{OUT}} = V_S / 2$, unless otherwise noted.

PARAMETER		CONDITIONS	OPA2188			UNIT
			MIN	TYP	MAX	
OFFSET VOLTAGE						
V_{OS}	Input offset voltage			6	25	μV
		$T_A = -40^\circ\text{C}$ to $+105^\circ\text{C}$		0.03	0.085	$\mu\text{V}/^\circ\text{C}$
PSRR	Power-supply rejection ratio	$V_S = 4\text{ V}$ to 36 V , $V_{\text{CM}} = V_S / 2$		0.075	0.3	$\mu\text{V}/\text{V}$
		$V_S = 4\text{ V}$ to 36 V , $V_{\text{CM}} = V_S / 2$, $T_A = -40^\circ\text{C}$ to $+105^\circ\text{C}$			0.3	$\mu\text{V}/\text{V}$
	Long-term stability			4 ⁽¹⁾		μV
	Channel separation, dc			1		$\mu\text{V}/\text{V}$
INPUT BIAS CURRENT						
I_B	Input bias current	$V_{\text{CM}} = V_S / 2$		± 160	± 850	pA
		$T_A = -40^\circ\text{C}$ to $+105^\circ\text{C}$			± 4	nA
I_{OS}	Input offset current			± 320	± 1700	pA
		$T_A = -40^\circ\text{C}$ to $+105^\circ\text{C}$			± 2	nA
NOISE						
e_n	Input voltage noise	$f = 0.1\text{ Hz}$ to 10 Hz		0.25		μV_{PP}
	Input voltage noise density	$f = 1\text{ kHz}$		8.8		$\text{nV}/\sqrt{\text{Hz}}$
i_n	Input current noise density	$f = 1\text{ kHz}$		7		$\text{fA}/\sqrt{\text{Hz}}$
INPUT VOLTAGE RANGE						
V_{CM}	Common-mode voltage range	$T_A = -40^\circ\text{C}$ to $+105^\circ\text{C}$	V^-		$(V^+) - 1.5$	V
CMRR	Common-mode rejection ratio	$(V^-) < V_{\text{CM}} < (V^+) - 1.5\text{ V}$	106	114		dB
		$(V^-) + 0.5\text{ V} < V_{\text{CM}} < (V^+) - 1.5\text{ V}$, $V_S = \pm 2\text{ V}$	114	120		dB
		$(V^-) + 0.5\text{ V} < V_{\text{CM}} < (V^+) - 1.5\text{ V}$, $V_S = \pm 2\text{ V}$, $T_A = -40^\circ\text{C}$ to $+105^\circ\text{C}$	110	120		dB
INPUT IMPEDANCE						
	Differential			100 6		$\text{M}\Omega$ pF
	Common-mode			6 95		$10^{12}\ \Omega$ pF
OPEN-LOOP GAIN						
A_{OL}	Open-loop voltage gain	$(V^-) + 500\text{ mV} < V_{\text{O}} < (V^+) - 500\text{ mV}$, $R_L = 5\text{ k}\Omega$, $V_S = 5\text{ V}$	110	120		dB
		$(V^-) + 500\text{ mV} < V_{\text{O}} < (V^+) - 500\text{ mV}$, $R_L = 10\text{ k}\Omega$	120	130		dB
		$(V^-) + 500\text{ mV} < V_{\text{O}} < (V^+) - 500\text{ mV}$, $R_L = 10\text{ k}\Omega$, $T_A = -40^\circ\text{C}$ to $+105^\circ\text{C}$	114	120		dB
FREQUENCY RESPONSE						
GBW	Gain-bandwidth product			2		MHz
SR	Slew rate	$G = +1$		0.8		$\text{V}/\mu\text{s}$
	Overload recovery time	$V_{\text{IN}} \times G = V_S$		1		μs
THD+N	Total harmonic distortion + noise	1 kHz, $G = 1$, $V_{\text{OUT}} = 1\text{ V}_{\text{RMS}}$		0.0001		%

 (1) 1000-hour life test at $+125^\circ\text{C}$ demonstrated randomly distributed variation in the range of measurement limits—approximately $4\ \mu\text{V}$.

ELECTRICAL CHARACTERISTICS:**Low-Voltage Operation, $V_S = \pm 2\text{ V}$ to $< \pm 4\text{ V}$ ($V_S = +4\text{ V}$ to $< +8\text{ V}$) (continued)**At $T_A = +25^\circ\text{C}$, $R_L = 10\text{ k}\Omega$ connected to $V_S / 2$, and $V_{\text{COM}} = V_{\text{OUT}} = V_S / 2$, unless otherwise noted.

PARAMETER		CONDITIONS	OPA2188			UNIT
			MIN	TYP	MAX	
OUTPUT						
Voltage output swing from rail		No load		6	15	mV
		$R_L = 10\text{ k}\Omega$		220	250	mV
		$R_L = 10\text{ k}\Omega$, $T_A = -40^\circ\text{C}$ to $+105^\circ\text{C}$		310	350	mV
I_{SC}	Short-circuit current		± 18			mA
R_O	Open-loop output resistance	$f = 1\text{ MHz}$, $I_O = 0$		120		Ω
C_{LOAD}	Capacitive load drive			1		nF
POWER SUPPLY						
V_S	Operating voltage range		4 to 36 (± 2 to ± 18)			V
I_Q Quiescent current (per amplifier)		$V_S = \pm 2\text{ V}$ to $V_S = \pm 4\text{ V}$		385	440	μA
		$I_O = 0\text{ mA}$, $T_A = -40^\circ\text{C}$ to $+105^\circ\text{C}$			525	μA
TEMPERATURE RANGE						
Temperature range		Specified		-40	+105	$^\circ\text{C}$
		Operating		-40	+125	$^\circ\text{C}$
		Storage		-65	+150	$^\circ\text{C}$

THERMAL INFORMATION: OPA2188

THERMAL METRIC ⁽¹⁾		OPA2188ID	OPA2188IDGK	UNITS
		D	DGK	
		8 PINS	8 PINS	
θ_{JA}	Junction-to-ambient thermal resistance	111.0	159.3	$^\circ\text{C}/\text{W}$
θ_{JCtop}	Junction-to-case (top) thermal resistance	54.9	37.4	
θ_{JB}	Junction-to-board thermal resistance	51.7	48.5	
ψ_{JT}	Junction-to-top characterization parameter	9.3	1.2	
ψ_{JB}	Junction-to-board characterization parameter	51.1	77.1	
θ_{Jcbot}	Junction-to-case (bottom) thermal resistance	n/a	n/a	

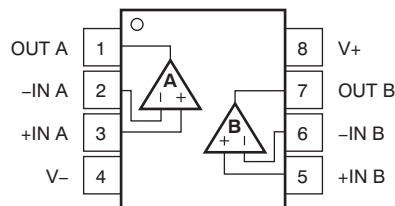
(1) For more information about traditional and new thermal metrics, see the *IC Package Thermal Metrics* application report, [SPRA953](#).**PIN CONFIGURATION****D, DGK PACKAGES
SO-8, MSOP-8
(TOP VIEW)**

TYPICAL CHARACTERISTICS

Table 1. Characteristic Performance Measurements

DESCRIPTION	FIGURE
Offset Voltage Production Distribution	Figure 1
Offset Voltage Drift Distribution	Figure 2
Offset Voltage vs Temperature	Figure 3
Offset Voltage vs Common-Mode Voltage	Figure 4, Figure 5
Offset Voltage vs Power Supply	Figure 6
I_B and I_{OS} vs Common-Mode Voltage	Figure 7
Input Bias Current vs Temperature	Figure 8
Output Voltage Swing vs Output Current (Maximum Supply)	Figure 9
CMRR and PSRR vs Frequency (Referred-to-Input)	Figure 10
CMRR vs Temperature	Figure 11, Figure 12
PSRR vs Temperature	Figure 13
0.1-Hz to 10-Hz Noise	Figure 14
Input Voltage Noise Spectral Density vs Frequency	Figure 15
THD+N Ratio vs Frequency	Figure 16
THD+N vs Output Amplitude	Figure 17
Quiescent Current vs Supply Voltage	Figure 18
Quiescent Current vs Temperature	Figure 19
Open-Loop Gain and Phase vs Frequency	Figure 20
Closed-Loop Gain vs Frequency	Figure 21
Open-Loop Gain vs Temperature	Figure 22
Open-Loop Output Impedance vs Frequency	Figure 23
Small-Signal Overshoot vs Capacitive Load (100-mV Output Step)	Figure 24, Figure 25
No Phase Reversal	Figure 26
Positive Overload Recovery	Figure 27
Negative Overload Recovery	Figure 28
Small-Signal Step Response (100 mV)	Figure 29, Figure 30
Large-Signal Step Response	Figure 31, Figure 32
Large-Signal Settling Time (10-V Positive Step)	Figure 33
Large-Signal Settling Time (10-V Negative Step)	Figure 34
Short-Circuit Current vs Temperature	Figure 35
Maximum Output Voltage vs Frequency	Figure 36
Channel Separation vs Frequency	Figure 37
EMIRR IN+ vs Frequency	Figure 38

TYPICAL CHARACTERISTICS

$V_S = \pm 18\text{ V}$, $V_{CM} = V_S / 2$, $R_{LOAD} = 10\text{ k}\Omega$ connected to $V_S / 2$, and $C_L = 100\text{ pF}$, unless otherwise noted.

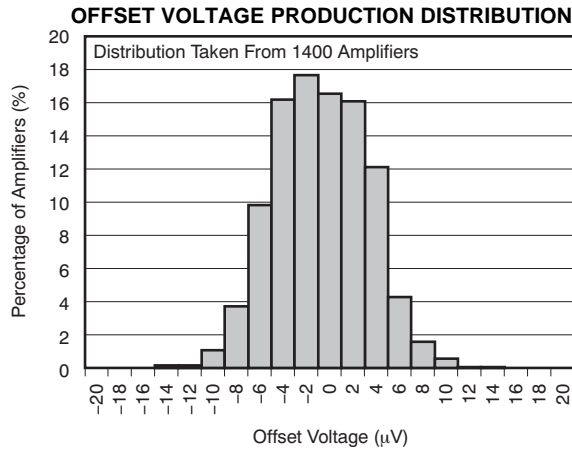

Figure 1.

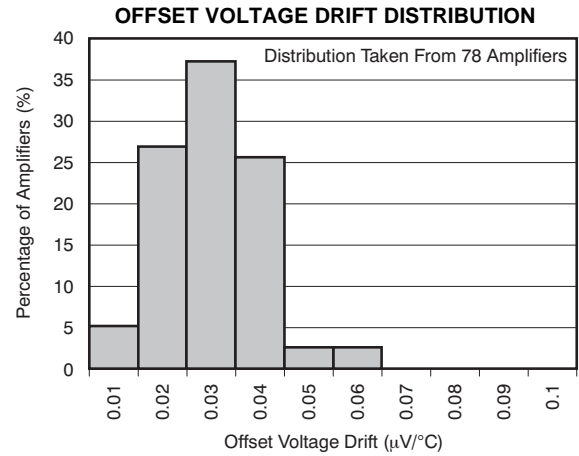

Figure 2.

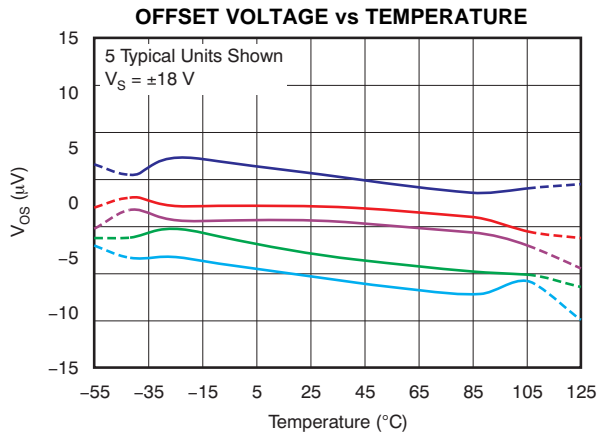

Figure 3.

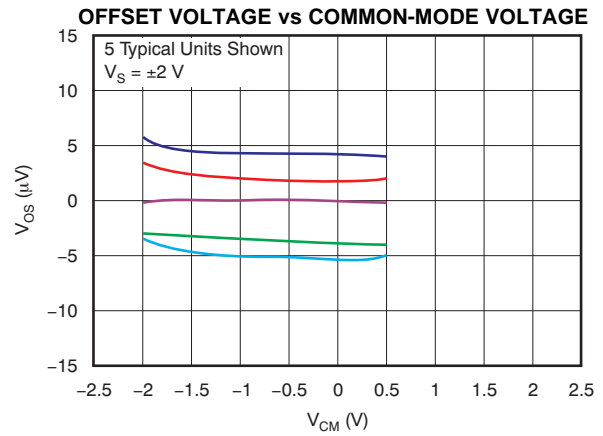

Figure 4.

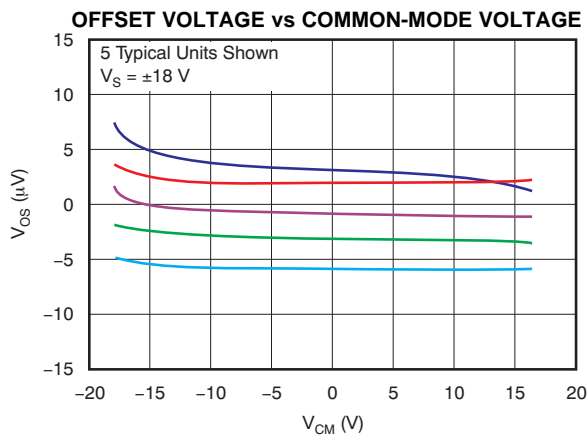

Figure 5.

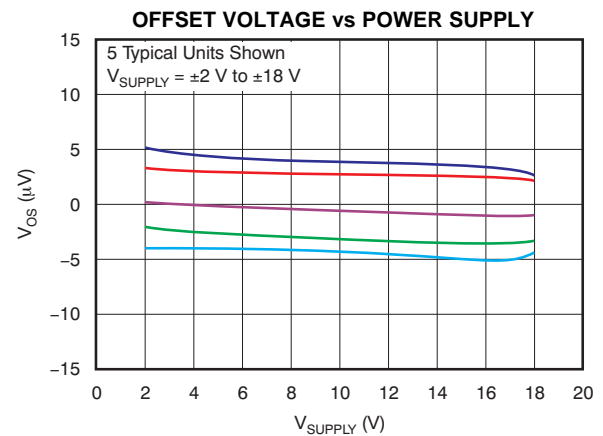

Figure 6.

TYPICAL CHARACTERISTICS (continued)

$V_S = \pm 18\text{ V}$, $V_{CM} = V_S / 2$, $R_{LOAD} = 10\text{ k}\Omega$ connected to $V_S / 2$, and $C_L = 100\text{ pF}$, unless otherwise noted.

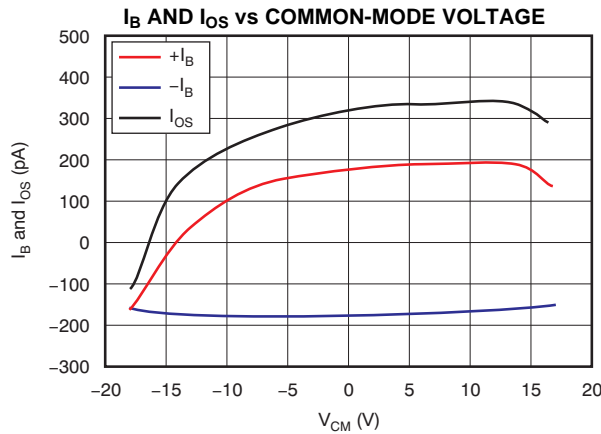

Figure 7.

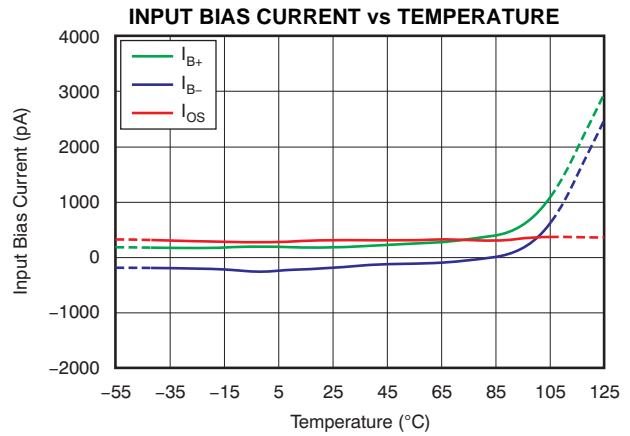

Figure 8.

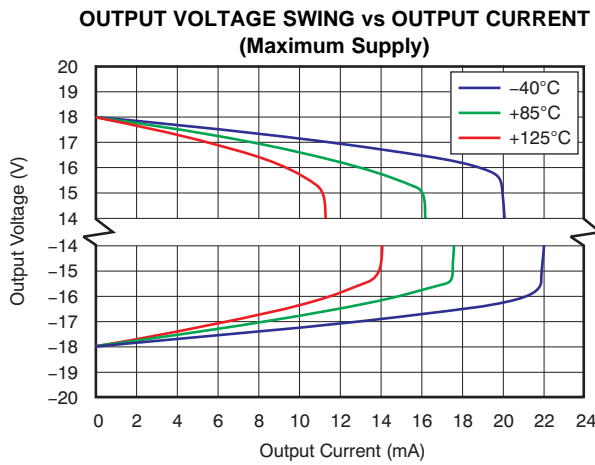

Figure 9.

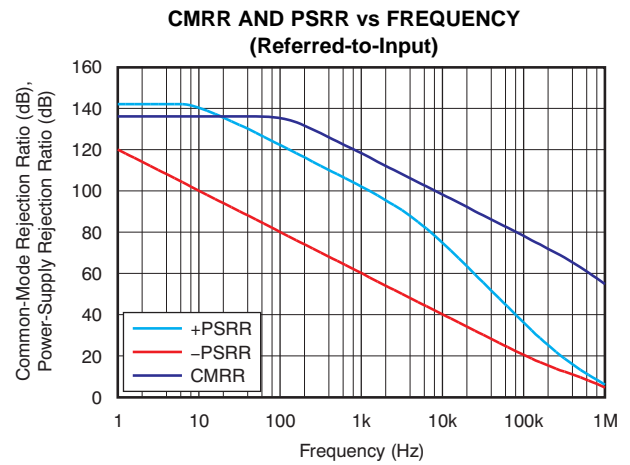

Figure 10.

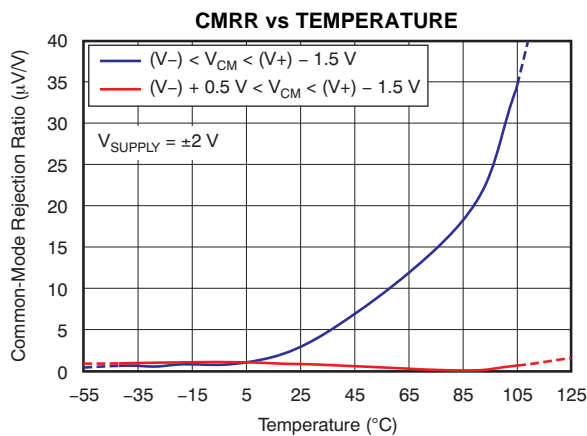

Figure 11.

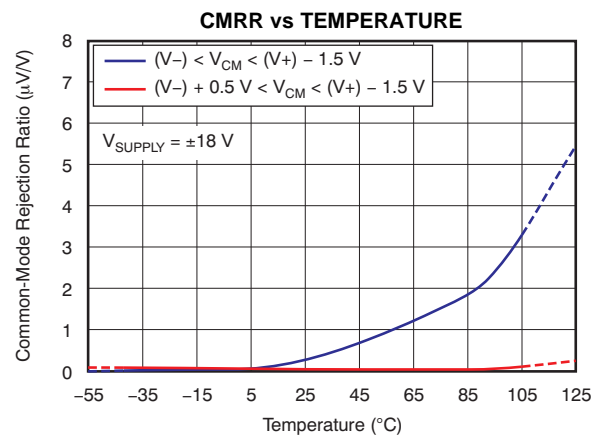

Figure 12.

TYPICAL CHARACTERISTICS (continued)

$V_S = \pm 18\text{ V}$, $V_{CM} = V_S / 2$, $R_{LOAD} = 10\text{ k}\Omega$ connected to $V_S / 2$, and $C_L = 100\text{ pF}$, unless otherwise noted.

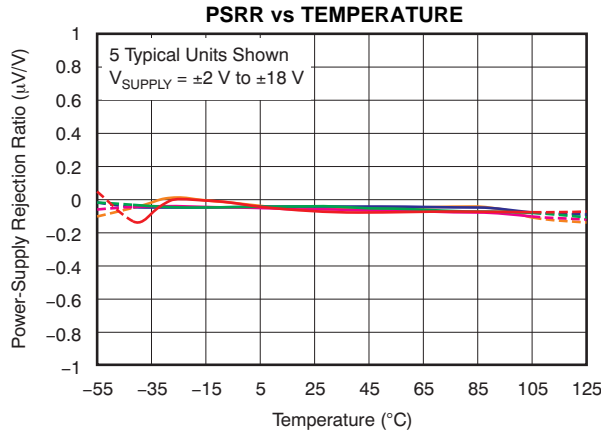

Figure 13.

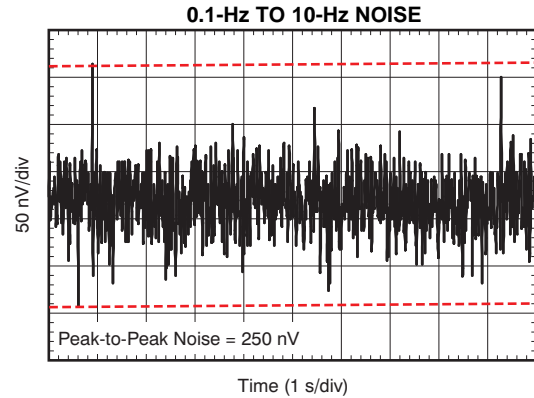

Figure 14.

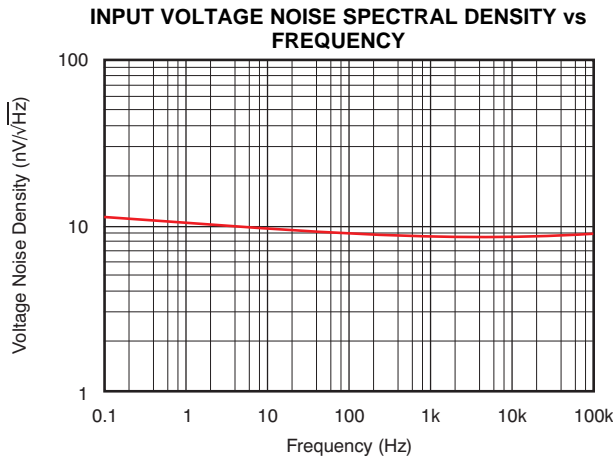

Figure 15.

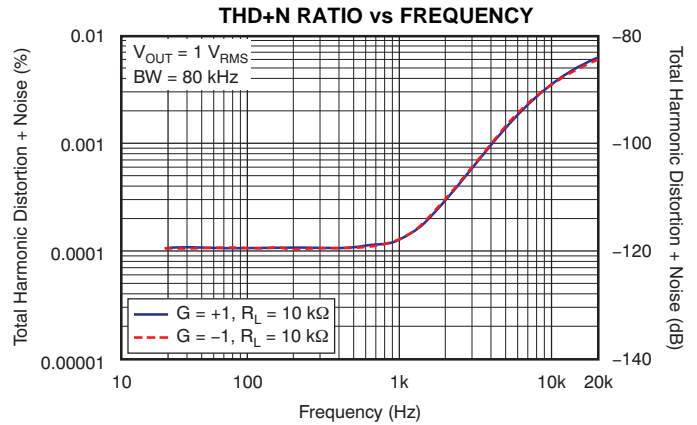

Figure 16.

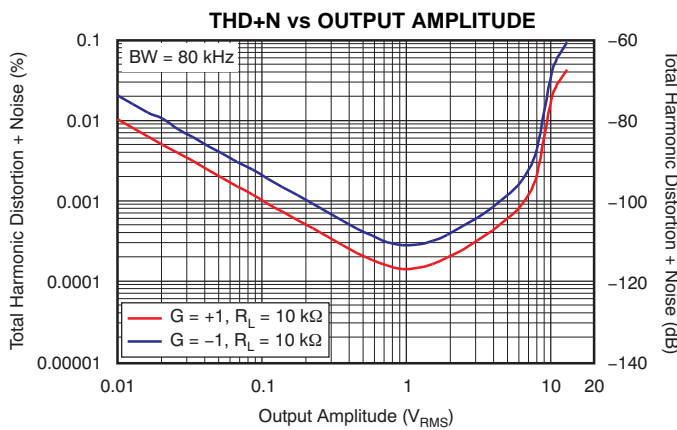

Figure 17.

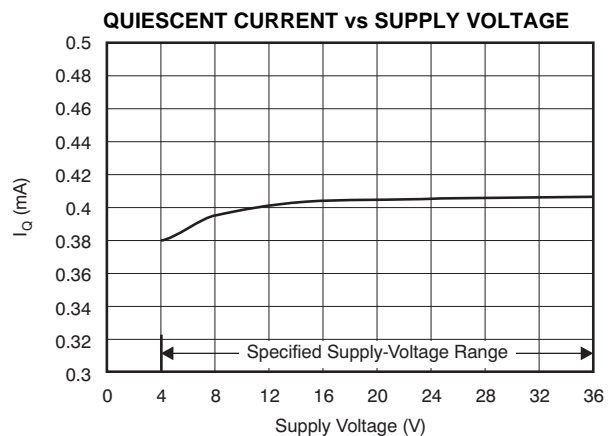

Figure 18.

TYPICAL CHARACTERISTICS (continued)

$V_S = \pm 18\text{ V}$, $V_{CM} = V_S / 2$, $R_{LOAD} = 10\text{ k}\Omega$ connected to $V_S / 2$, and $C_L = 100\text{ pF}$, unless otherwise noted.

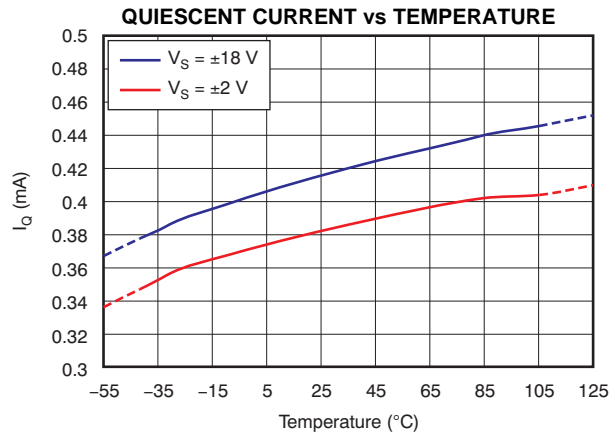

Figure 19.

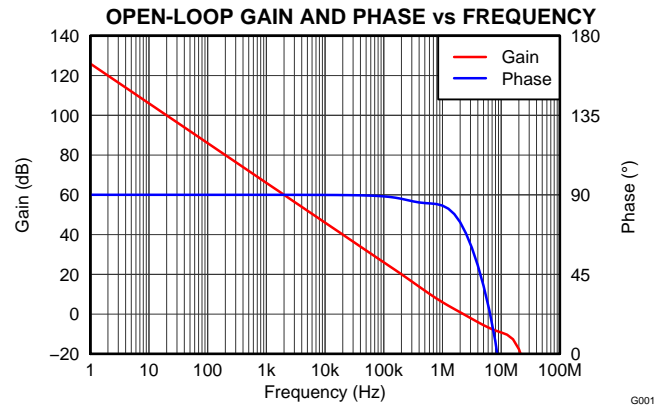

Figure 20.

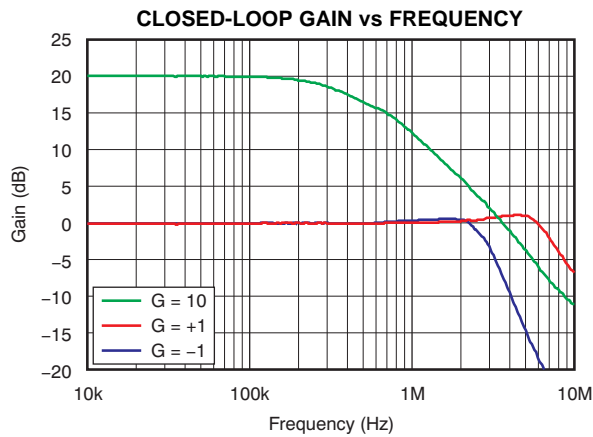

Figure 21.

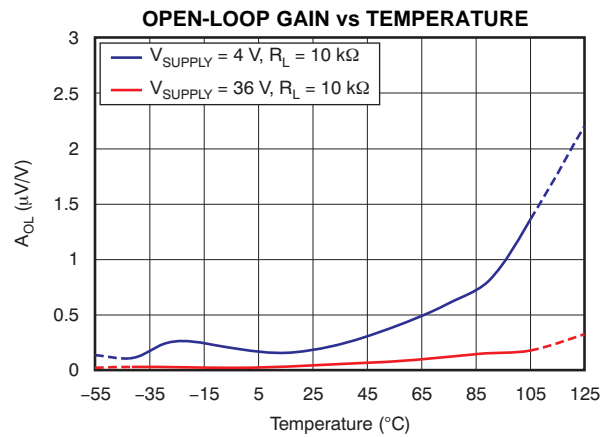

Figure 22.

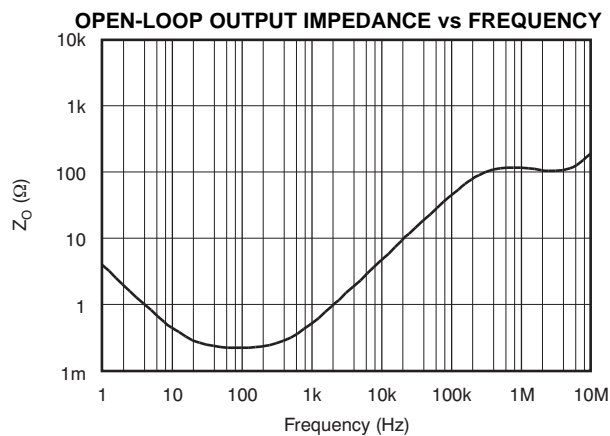

Figure 23.

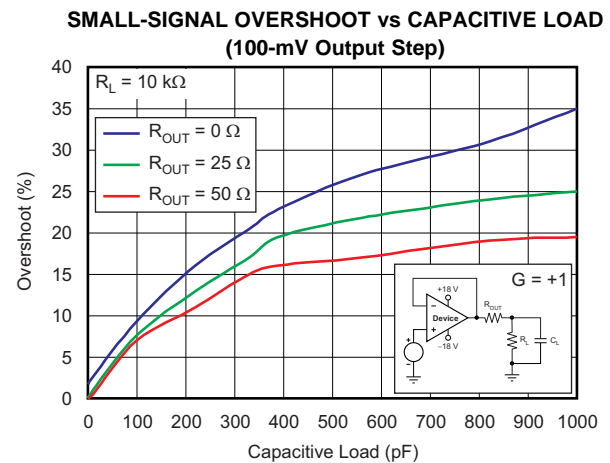

Figure 24.

TYPICAL CHARACTERISTICS (continued)

$V_S = \pm 18\text{ V}$, $V_{CM} = V_S / 2$, $R_{LOAD} = 10\text{ k}\Omega$ connected to $V_S / 2$, and $C_L = 100\text{ pF}$, unless otherwise noted.

**SMALL-SIGNAL OVERSHOOT vs CAPACITIVE LOAD
(100-mV Output Step)**

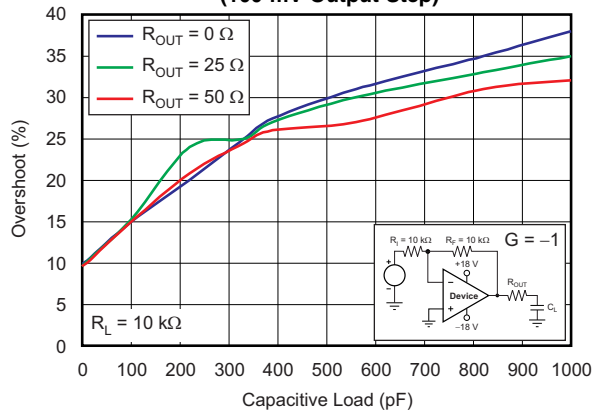

Figure 25.

NO PHASE REVERSAL

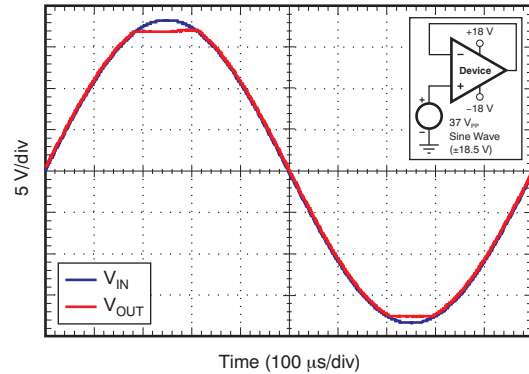

Figure 26.

POSITIVE OVERLOAD RECOVERY

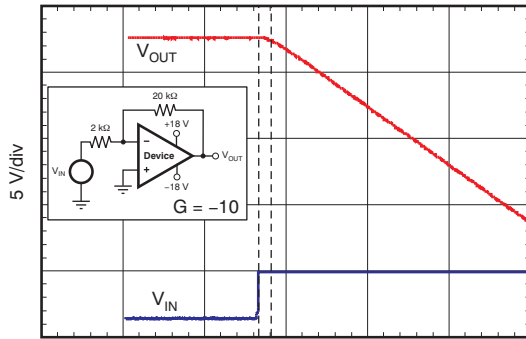

Figure 27.

NEGATIVE OVERLOAD RECOVERY

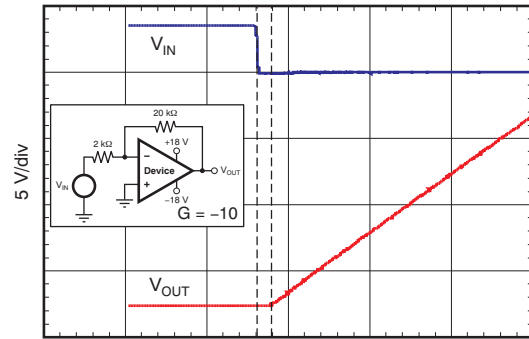

Figure 28.

**SMALL-SIGNAL STEP RESPONSE
(100 mV)**

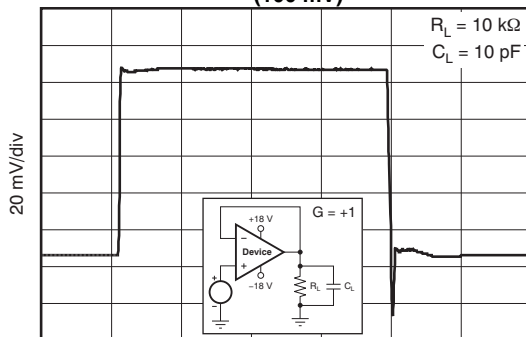

Figure 29.

**SMALL-SIGNAL STEP RESPONSE
(100 mV)**

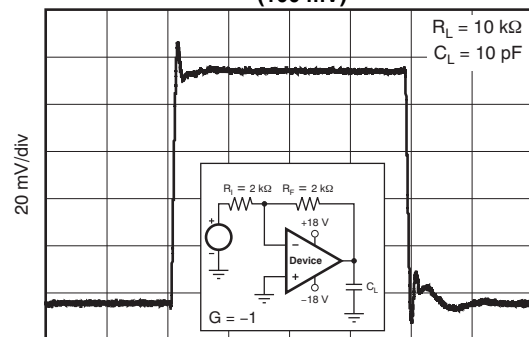

Figure 30.

TYPICAL CHARACTERISTICS (continued)

$V_S = \pm 18\text{ V}$, $V_{CM} = V_S / 2$, $R_{LOAD} = 10\text{ k}\Omega$ connected to $V_S / 2$, and $C_L = 100\text{ pF}$, unless otherwise noted.

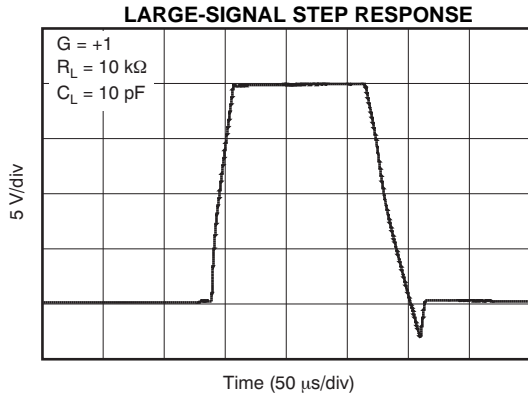

Figure 31.

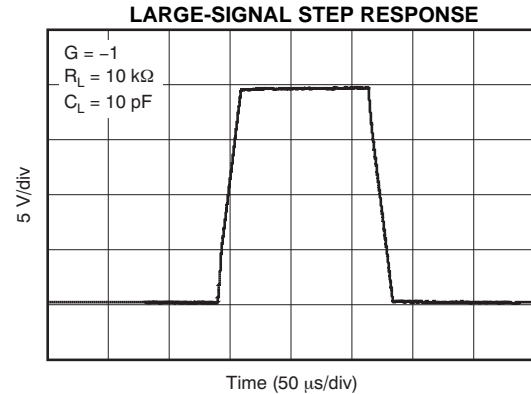

Figure 32.

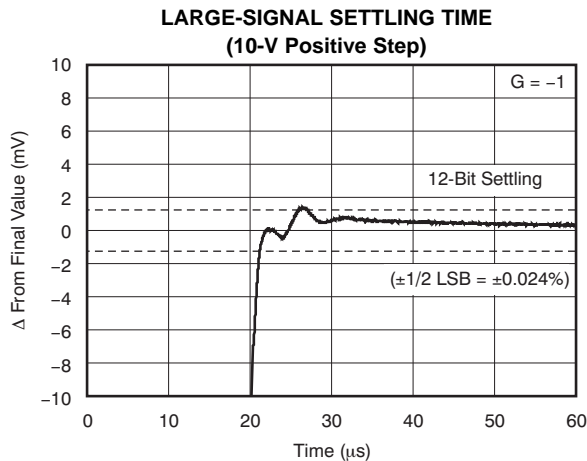

Figure 33.

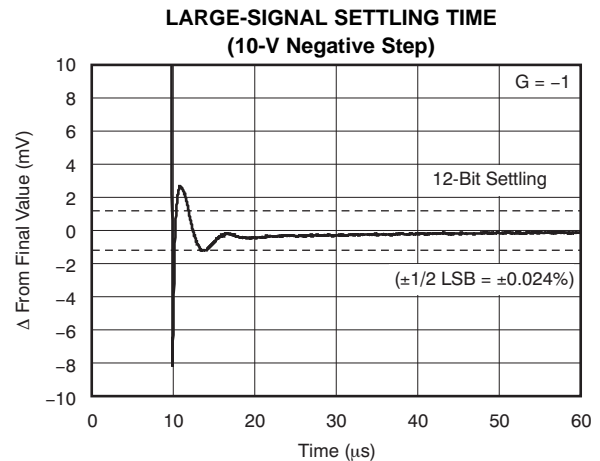

Figure 34.

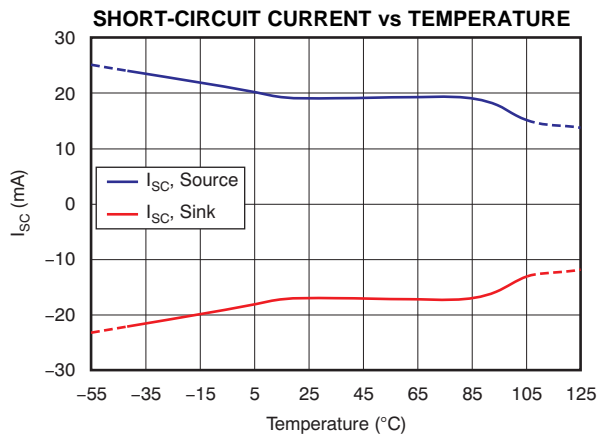

Figure 35.

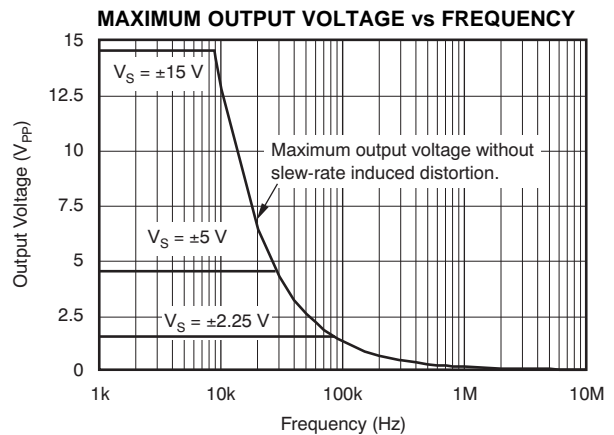

Figure 36.

TYPICAL CHARACTERISTICS (continued)

$V_S = \pm 18\text{ V}$, $V_{CM} = V_S / 2$, $R_{LOAD} = 10\text{ k}\Omega$ connected to $V_S / 2$, and $C_L = 100\text{ pF}$, unless otherwise noted.

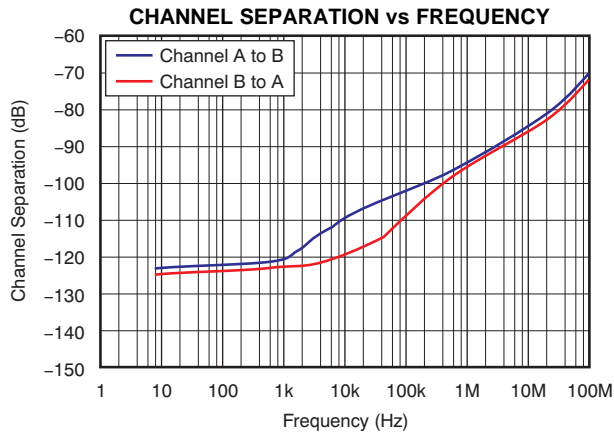

Figure 37.

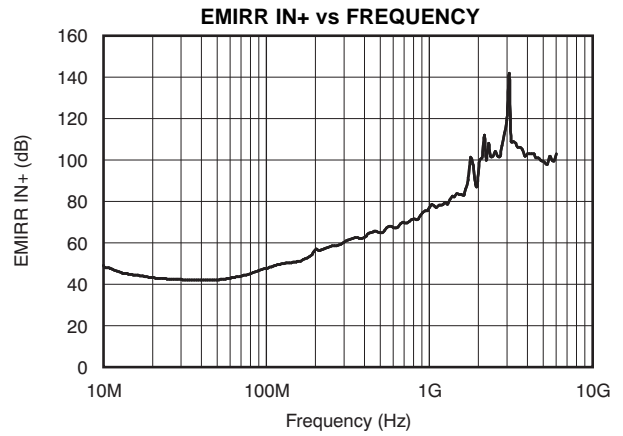

Figure 38.

APPLICATION INFORMATION

The OPA2188 operational amplifier combines precision offset and drift with excellent overall performance, making the device ideal for many precision applications. The precision offset drift of only 0.085 μV per degree Celsius provides stability over the entire temperature range. In addition, the device offers excellent overall performance with high CMRR, PSRR, and A_{OL} . As with all amplifiers, applications with noisy or high-impedance power supplies require decoupling capacitors close to the device pins. In most cases, 0.1- μF capacitors are adequate.

OPERATING CHARACTERISTICS

The OPA2188 is specified for operation from 4 V to 36 V (± 2 V to ± 18 V). Many of the specifications apply from -40°C to $+105^\circ\text{C}$. Parameters that can exhibit significant variance with regard to operating voltage or temperature are presented in the [Typical Characteristics](#).

EMI REJECTION

The OPA2188 uses integrated electromagnetic interference (EMI) filtering to reduce the effects of EMI interference from sources such as wireless communications and densely populated boards with a mix of analog signal chain and digital components. EMI immunity can be improved with circuit design techniques; the OPAx188 benefits from these design improvements. Texas Instruments has developed the ability to accurately measure and quantify the immunity of an operational amplifier over a broad frequency spectrum extending from 10 MHz to 6 GHz. [Figure 39](#) shows the results of this testing on the OPA2188. Detailed information can also be found in the [Application Report EMI Rejection Ratio of Operational Amplifiers \(SBOA128\)](#), available for download from the TI website.

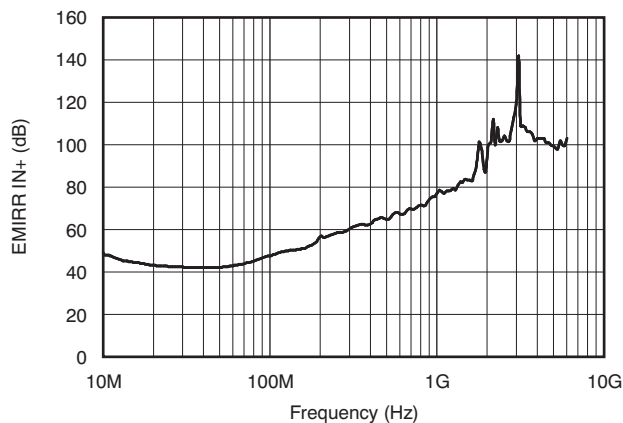

Figure 39. EMIRR Testing

GENERAL LAYOUT GUIDELINES

For best operational performance of the device, good printed circuit board (PCB) layout practices are recommended. Low-loss, 0.1- μ F bypass capacitors should be connected between each supply pin and ground, placed as close to the device as possible. A single bypass capacitor from V+ to ground is applicable to single-supply applications.

PHASE-REVERSAL PROTECTION

The OPA2188 has an internal phase-reversal protection. Many op amps exhibit a phase reversal when the input is driven beyond its linear common-mode range. This condition is most often encountered in noninverting circuits when the input is driven beyond the specified common-mode voltage range, causing the output to reverse into the opposite rail. The OPA2188 input prevents phase reversal with excessive common-mode voltage. Instead, the output limits into the appropriate rail. This performance is shown in Figure 40.

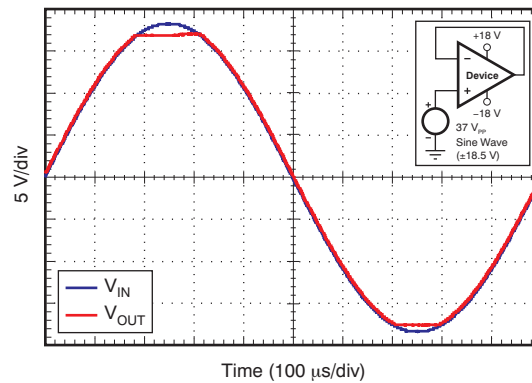

Figure 40. No Phase Reversal

CAPACITIVE LOAD AND STABILITY

The dynamic characteristics of the OPA2188 have been optimized for a range of common operating conditions. The combination of low closed-loop gain and high capacitive loads decreases the phase margin of the amplifier and can lead to gain peaking or oscillations. As a result, heavier capacitive loads must be isolated from the output. The simplest way to achieve this isolation is to add a small resistor (for example, R_{OUT} equal to 50 Ω) in series with the output. Figure 41 and Figure 42 illustrate graphs of small-signal overshoot versus capacitive load for several values of R_{OUT} . Also, refer to the Applications Report, *Feedback Plots Define Op Amp AC Performance* (SBOA015), available for download from the TI website, for details of analysis techniques and application circuits.

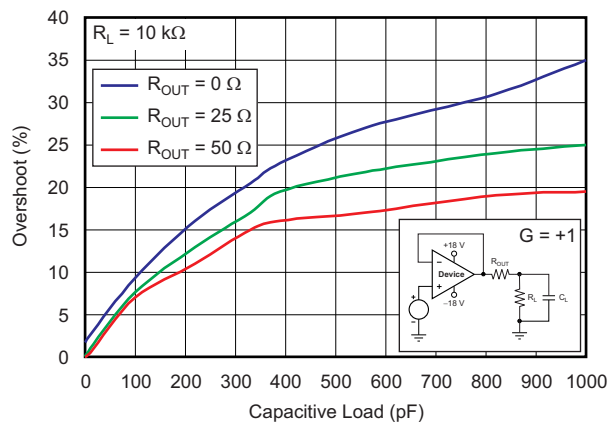

Figure 41. Small-Signal Overshoot versus Capacitive Load (100-mV Output Step)

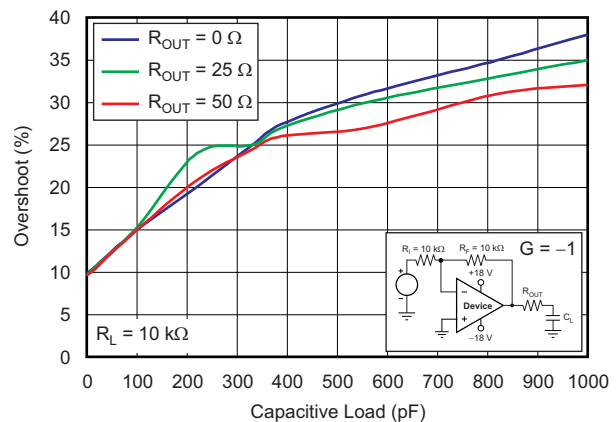

Figure 42. Small-Signal Overshoot versus Capacitive Load (100-mV Output Step)

ELECTRICAL OVERSTRESS

Designers often ask questions about the capability of an operational amplifier to withstand electrical overstress. These questions tend to focus on the device inputs, but may involve the supply voltage pins or even the output pin. Each of these different pin functions have electrical stress limits determined by the voltage breakdown characteristics of the particular semiconductor fabrication process and specific circuits connected to the pin. Additionally, internal electrostatic discharge (ESD) protection is built into these circuits to protect them from accidental ESD events both before and during product assembly.

These ESD protection diodes also provide in-circuit, input overdrive protection, as long as the current is limited to 10 mA as stated in the [Absolute Maximum Ratings](#). [Figure 43](#) shows how a series input resistor may be added to the driven input to limit the input current. The added resistor contributes thermal noise at the amplifier input and its value should be kept to a minimum in noise-sensitive applications.

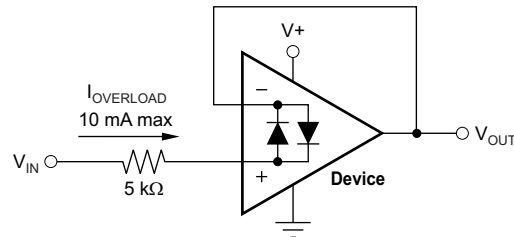

Figure 43. Input Current Protection

An ESD event produces a short duration, high-voltage pulse that is transformed into a short duration, high-current pulse as it discharges through a semiconductor device. The ESD protection circuits are designed to provide a current path around the operational amplifier core to prevent it from being damaged. The energy absorbed by the protection circuitry is then dissipated as heat.

When the operational amplifier connects into a circuit, the ESD protection components are intended to remain inactive and not become involved in the application circuit operation. However, circumstances may arise where an applied voltage exceeds the operating voltage range of a given pin. Should this condition occur, there is a risk that some of the internal ESD protection circuits may be biased on, and conduct current. Any such current flow occurs through ESD cells and rarely involves the absorption device.

If there is an uncertainty about the ability of the supply to absorb this current, external zener diodes may be added to the supply pins. The zener voltage must be selected such that the diode does not turn on during normal operation.

However, its zener voltage should be low enough so that the zener diode conducts if the supply pin begins to rise above the safe operating supply voltage level.

APPLICATION EXAMPLES

The application examples of [Figure 44](#) and [Figure 45](#) highlight only a few of the circuits where the OPA2188 can be used.

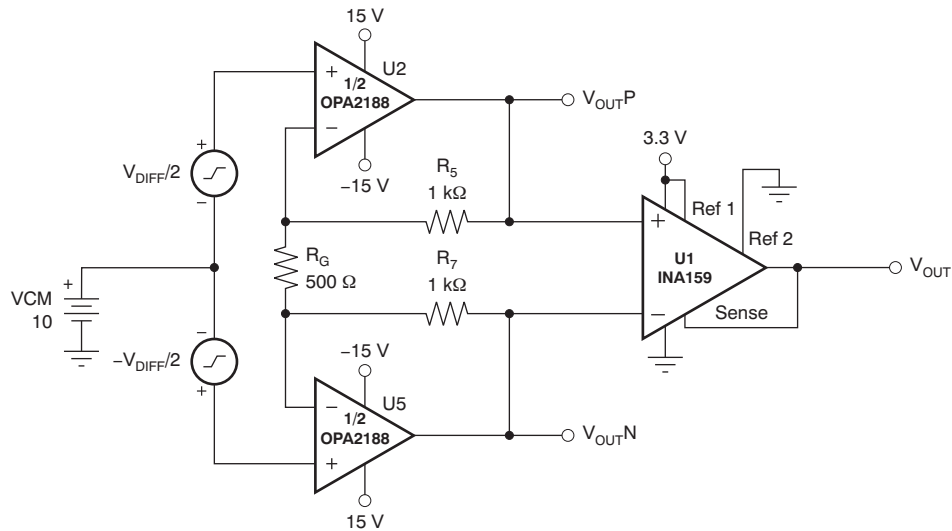
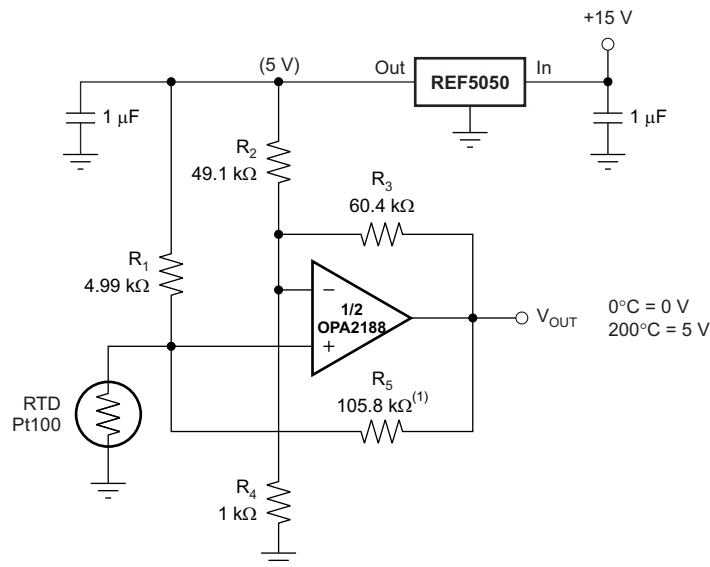

Figure 44. Discrete INA + Attenuation for ADC with 3.3-V Supply



(1) R₅ provides positive-varying excitation to linearize output.

Figure 45. RTD Amplifier with Linearization

REVISION HISTORY

NOTE: Page numbers for previous revisions may differ from page numbers in the current version.

Changes from Revision A (June 2012) to Revision B**Page**

-
- Changed second to last Applications bullet [1](#)
-

PACKAGING INFORMATION

Orderable Device	Status ⁽¹⁾	Package Type	Package Drawing	Pins	Package Qty	Eco Plan ⁽²⁾	Lead/ Ball Finish	MSL Peak Temp ⁽³⁾	Samples (Requires Login)
OPA2188AID	ACTIVE	SOIC	D	8	75	Green (RoHS & no Sb/Br)	CU NIPDAU	Level-2-260C-1 YEAR	
OPA2188AIDGKR	ACTIVE	VSSOP	DGK	8	2500	Green (RoHS & no Sb/Br)	CU NIPDAU	Level-2-260C-1 YEAR	
OPA2188AIDGKT	ACTIVE	VSSOP	DGK	8	250	Green (RoHS & no Sb/Br)	CU NIPDAU	Level-2-260C-1 YEAR	
OPA2188AIDR	ACTIVE	SOIC	D	8	2500	Green (RoHS & no Sb/Br)	CU NIPDAU	Level-2-260C-1 YEAR	

⁽¹⁾ The marketing status values are defined as follows:

ACTIVE: Product device recommended for new designs.

LIFEBUY: TI has announced that the device will be discontinued, and a lifetime-buy period is in effect.

NRND: Not recommended for new designs. Device is in production to support existing customers, but TI does not recommend using this part in a new design.

PREVIEW: Device has been announced but is not in production. Samples may or may not be available.

OBSELETE: TI has discontinued the production of the device.

⁽²⁾ Eco Plan - The planned eco-friendly classification: Pb-Free (RoHS), Pb-Free (RoHS Exempt), or Green (RoHS & no Sb/Br) - please check <http://www.ti.com/productcontent> for the latest availability information and additional product content details.

TBD: The Pb-Free/Green conversion plan has not been defined.

Pb-Free (RoHS): TI's terms "Lead-Free" or "Pb-Free" mean semiconductor products that are compatible with the current RoHS requirements for all 6 substances, including the requirement that lead not exceed 0.1% by weight in homogeneous materials. Where designed to be soldered at high temperatures, TI Pb-Free products are suitable for use in specified lead-free processes.

Pb-Free (RoHS Exempt): This component has a RoHS exemption for either 1) lead-based flip-chip solder bumps used between the die and package, or 2) lead-based die adhesive used between the die and leadframe. The component is otherwise considered Pb-Free (RoHS compatible) as defined above.

Green (RoHS & no Sb/Br): TI defines "Green" to mean Pb-Free (RoHS compatible), and free of Bromine (Br) and Antimony (Sb) based flame retardants (Br or Sb do not exceed 0.1% by weight in homogeneous material)

⁽³⁾ MSL, Peak Temp. -- The Moisture Sensitivity Level rating according to the JEDEC industry standard classifications, and peak solder temperature.

Important Information and Disclaimer: The information provided on this page represents TI's knowledge and belief as of the date that it is provided. TI bases its knowledge and belief on information provided by third parties, and makes no representation or warranty as to the accuracy of such information. Efforts are underway to better integrate information from third parties. TI has taken and continues to take reasonable steps to provide representative and accurate information but may not have conducted destructive testing or chemical analysis on incoming materials and chemicals. TI and TI suppliers consider certain information to be proprietary, and thus CAS numbers and other limited information may not be available for release.

In no event shall TI's liability arising out of such information exceed the total purchase price of the TI part(s) at issue in this document sold by TI to Customer on an annual basis.

TAPE AND REEL INFORMATION

QUADRANT ASSIGNMENTS FOR PIN 1 ORIENTATION IN TAPE

*All dimensions are nominal

Device	Package Type	Package Drawing	Pins	SPQ	Reel Diameter (mm)	Reel Width W1 (mm)	A0 (mm)	B0 (mm)	K0 (mm)	P1 (mm)	W (mm)	Pin1 Quadrant
OPA2188AIDGKR	VSSOP	DGK	8	2500	330.0	12.4	5.3	3.4	1.4	8.0	12.0	Q1
OPA2188AIDGKR	VSSOP	DGK	8	2500	330.0	12.4	5.3	3.4	1.4	8.0	12.0	Q1
OPA2188AIDGKT	VSSOP	DGK	8	250	177.8	12.4	5.3	3.4	1.4	8.0	12.0	Q1
OPA2188AIDGKT	VSSOP	DGK	8	250	330.0	12.4	5.3	3.4	1.4	8.0	12.0	Q1
OPA2188AIDR	SOIC	D	8	2500	330.0	12.4	6.4	5.2	2.1	8.0	12.0	Q1

TAPE AND REEL BOX DIMENSIONS

*All dimensions are nominal

Device	Package Type	Package Drawing	Pins	SPQ	Length (mm)	Width (mm)	Height (mm)
OPA2188AIDGKR	VSSOP	DGK	8	2500	358.0	335.0	35.0
OPA2188AIDGKR	VSSOP	DGK	8	2500	366.0	364.0	50.0
OPA2188AIDGKT	VSSOP	DGK	8	250	202.0	201.0	28.0
OPA2188AIDGKT	VSSOP	DGK	8	250	366.0	364.0	50.0
OPA2188AIDR	SOIC	D	8	2500	367.0	367.0	35.0

DGK (S-PDSO-G8)

PLASTIC SMALL-OUTLINE PACKAGE



- NOTES:
- A. All linear dimensions are in millimeters.
 - B. This drawing is subject to change without notice.
 - C. Body length does not include mold flash, protrusions, or gate burrs. Mold flash, protrusions, or gate burrs shall not exceed 0.15 per end.
 - D. Body width does not include interlead flash. Interlead flash shall not exceed 0.50 per side.
 - E. Falls within JEDEC MO-187 variation AA, except interlead flash.

D (R-PDSO-G8)

PLASTIC SMALL OUTLINE



D (R-PDSO-G8)

PLASTIC SMALL OUTLINE



- NOTES:
- All linear dimensions are in millimeters.
 - This drawing is subject to change without notice.
 - Publication IPC-7351 is recommended for alternate designs.
 - Laser cutting apertures with trapezoidal walls and also rounding corners will offer better paste release. Customers should contact their board assembly site for stencil design recommendations. Refer to IPC-7525 for other stencil recommendations.
 - Customers should contact their board fabrication site for solder mask tolerances between and around signal pads.

IMPORTANT NOTICE

Texas Instruments Incorporated and its subsidiaries (TI) reserve the right to make corrections, enhancements, improvements and other changes to its semiconductor products and services per JESD46, latest issue, and to discontinue any product or service per JESD48, latest issue. Buyers should obtain the latest relevant information before placing orders and should verify that such information is current and complete. All semiconductor products (also referred to herein as "components") are sold subject to TI's terms and conditions of sale supplied at the time of order acknowledgment.

TI warrants performance of its components to the specifications applicable at the time of sale, in accordance with the warranty in TI's terms and conditions of sale of semiconductor products. Testing and other quality control techniques are used to the extent TI deems necessary to support this warranty. Except where mandated by applicable law, testing of all parameters of each component is not necessarily performed.

TI assumes no liability for applications assistance or the design of Buyers' products. Buyers are responsible for their products and applications using TI components. To minimize the risks associated with Buyers' products and applications, Buyers should provide adequate design and operating safeguards.

TI does not warrant or represent that any license, either express or implied, is granted under any patent right, copyright, mask work right, or other intellectual property right relating to any combination, machine, or process in which TI components or services are used. Information published by TI regarding third-party products or services does not constitute a license to use such products or services or a warranty or endorsement thereof. Use of such information may require a license from a third party under the patents or other intellectual property of the third party, or a license from TI under the patents or other intellectual property of TI.

Reproduction of significant portions of TI information in TI data books or data sheets is permissible only if reproduction is without alteration and is accompanied by all associated warranties, conditions, limitations, and notices. TI is not responsible or liable for such altered documentation. Information of third parties may be subject to additional restrictions.

Resale of TI components or services with statements different from or beyond the parameters stated by TI for that component or service voids all express and any implied warranties for the associated TI component or service and is an unfair and deceptive business practice. TI is not responsible or liable for any such statements.

Buyer acknowledges and agrees that it is solely responsible for compliance with all legal, regulatory and safety-related requirements concerning its products, and any use of TI components in its applications, notwithstanding any applications-related information or support that may be provided by TI. Buyer represents and agrees that it has all the necessary expertise to create and implement safeguards which anticipate dangerous consequences of failures, monitor failures and their consequences, lessen the likelihood of failures that might cause harm and take appropriate remedial actions. Buyer will fully indemnify TI and its representatives against any damages arising out of the use of any TI components in safety-critical applications.

In some cases, TI components may be promoted specifically to facilitate safety-related applications. With such components, TI's goal is to help enable customers to design and create their own end-product solutions that meet applicable functional safety standards and requirements. Nonetheless, such components are subject to these terms.

No TI components are authorized for use in FDA Class III (or similar life-critical medical equipment) unless authorized officers of the parties have executed a special agreement specifically governing such use.

Only those TI components which TI has specifically designated as military grade or "enhanced plastic" are designed and intended for use in military/aerospace applications or environments. Buyer acknowledges and agrees that any military or aerospace use of TI components which have **not** been so designated is solely at the Buyer's risk, and that Buyer is solely responsible for compliance with all legal and regulatory requirements in connection with such use.

TI has specifically designated certain components which meet ISO/TS16949 requirements, mainly for automotive use. Components which have not been so designated are neither designed nor intended for automotive use; and TI will not be responsible for any failure of such components to meet such requirements.

Products

Audio	www.ti.com/audio
Amplifiers	amplifier.ti.com
Data Converters	dataconverter.ti.com
DLP® Products	www.dlp.com
DSP	dsp.ti.com
Clocks and Timers	www.ti.com/clocks
Interface	interface.ti.com
Logic	logic.ti.com
Power Mgmt	power.ti.com
Microcontrollers	microcontroller.ti.com
RFID	www.ti-rfid.com
OMAP Applications Processors	www.ti.com/omap
Wireless Connectivity	www.ti.com/wirelessconnectivity

Applications

Automotive and Transportation	www.ti.com/automotive
Communications and Telecom	www.ti.com/communications
Computers and Peripherals	www.ti.com/computers
Consumer Electronics	www.ti.com/consumer-apps
Energy and Lighting	www.ti.com/energy
Industrial	www.ti.com/industrial
Medical	www.ti.com/medical
Security	www.ti.com/security
Space, Avionics and Defense	www.ti.com/space-avionics-defense
Video and Imaging	www.ti.com/video

TI E2E Community

e2e.ti.com