

NRTSAF360, NRVTSAF360

Trench-based Schottky Rectifier

Features

- Fine Lithography Trench-based Schottky Technology for Very Low Forward Voltage and Low Leakage
- Fast Switching with Exceptional Temperature Stability
- Low Power Loss and Lower Operating Temperature
- Higher Efficiency for Achieving Regulatory Compliance
- High Surge Capability
- NRV Prefix for Automotive and Other Applications Requiring Unique Site and Control Change Requirements; AEC-Q101 Qualified and PPAP Capable
- These are Pb-Free and Halide-Free Devices

Typical Applications

- Switching Power Supplies including Tablet Adapters, and Flat Panel Display
- High Frequency and DC-DC Converters
- Freewheeling and OR-ing diodes
- Reverse Battery Protection
- Instrumentation
- Automotive LED Lighting

Mechanical Characteristics:

- Case: Epoxy, Molded
- Epoxy Meets Flammability Rating UL 94-0 @ 0.125 in.
- Lead Finish: 100% Matte Sn (Tin)
- Lead and Mounting Surface Temperature for Soldering Purposes: 260°C Max. for 10 Seconds
- Device Meets MSL 1 Requirements
- Weight: 95 mg (Approximately)



ON Semiconductor®

www.onsemi.com

**TRENCH SCHOTTKY
RECTIFIER
3.0 AMPERE
60 VOLTS**



**SMA-FL
CASE 403AA
STYLE 6**

MARKING DIAGRAM

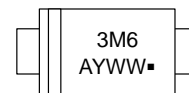

3M6 = Specific Device Code
A = Assembly Location
Y = Year
WW = Work Week
▪ = Pb-Free Package

ORDERING INFORMATION

Device	Package	Shipping†
NRTSAF360T3G	SMA-FL (Pb-Free)	5000 / Tape & Reel
NRVTSAF360T3G	SMA-FL (Pb-Free)	5000 / Tape & Reel

†For information on tape and reel specifications, including part orientation and tape sizes, please refer to our Tape and Reel Packaging Specification Brochure, BRD8011/D.

NRTSAF360, NRVTSAF360

MAXIMUM RATINGS

Rating	Symbol	Value	Unit
Peak Repetitive Reverse Voltage Working Peak Reverse Voltage DC Blocking Voltage	V_{RRM} V_{RWM} V_R	60	V
Average Rectified Forward Current ($T_L = 143^\circ\text{C}$)	I_O	3.0	A
Peak Repetitive Forward Current (Rated V_R , Square Wave, 20 kHz) $T_L = 138^\circ\text{C}$	I_{FRM}	6.0	A
Non-Repetitive Peak Surge Current (Surge Applied at Rated Load Conditions Halfwave, Single Phase, 60 Hz)	I_{FSM}	100	A
Storage Temperature Range	T_{stg}	-65 to +175	$^\circ\text{C}$
Operating Junction Temperature (Note 1)	T_J	-55 to +175	$^\circ\text{C}$

Stresses exceeding those listed in the Maximum Ratings table may damage the device. If any of these limits are exceeded, device functionality should not be assumed, damage may occur and reliability may be affected.

1. The heat generated must be less than the thermal conductivity from Junction-to-Ambient: $dP_D/dT_J < 1/R_{\theta JA}$.

THERMAL CHARACTERISTICS

Characteristic	Symbol	Value	Unit
Thermal Resistance, Junction-to-Lead (Note 2)	Ψ_{JCL}	24.5	$^\circ\text{C/W}$
Thermal Resistance, Junction-to-Ambient (Note 2)	$R_{\theta JA}$	81	$^\circ\text{C/W}$

2. 1 inch square pad size (1 × 0.5 inch) for each lead on FR4 board.

ELECTRICAL CHARACTERISTICS

Rating	Symbol	Typ	Max	Unit
Instantaneous Forward Voltage (Note 3) ($I_F = 3\text{ A}$, $T_J = 25^\circ\text{C}$) ($I_F = 3\text{ A}$, $T_J = 125^\circ\text{C}$) ($I_F = 6\text{ A}$, $T_J = 25^\circ\text{C}$)	V_F	0.48 0.41 0.57	0.64 0.58 0.78	V
Instantaneous Reverse Current (Note 3) (Rated dc Voltage, $T_J = 25^\circ\text{C}$) (Rated dc Voltage, $T_J = 125^\circ\text{C}$)	I_R	4.5 3.5	50 15	μA mA

Product parametric performance is indicated in the Electrical Characteristics for the listed test conditions, unless otherwise noted. Product performance may not be indicated by the Electrical Characteristics if operated under different conditions.

3. Pulse Test: Pulse Width $\leq 380\ \mu\text{s}$, Duty Cycle $\leq 2.0\%$.

NRTSAF360, NRVTSAF360

TYPICAL CHARACTERISTICS

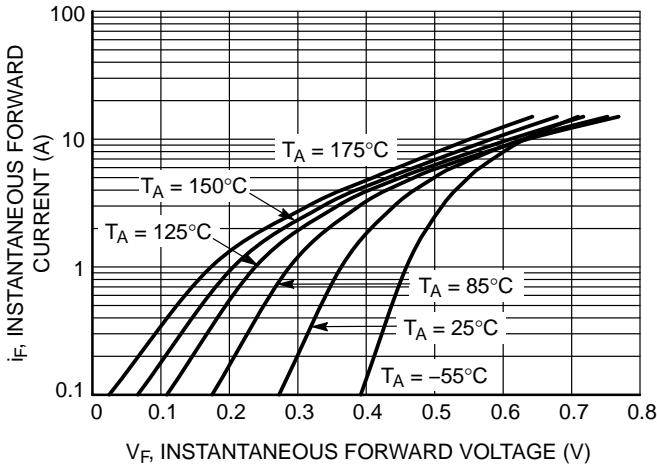

Figure 1. Typical Instantaneous Forward Characteristics

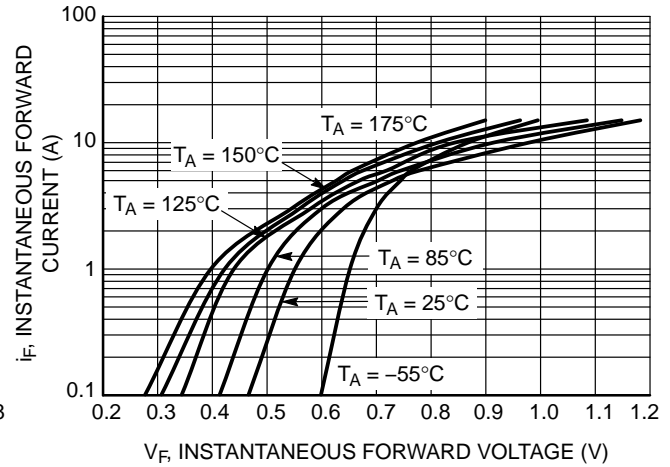

Figure 2. Maximum Instantaneous Forward Characteristics

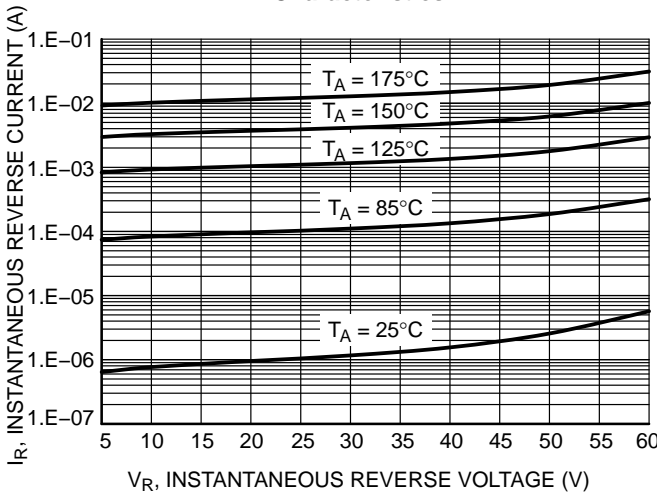

Figure 3. Typical Reverse Characteristics

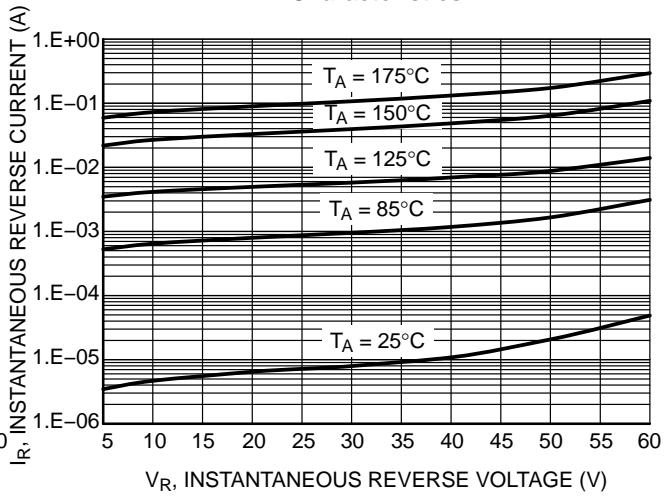

Figure 4. Maximum Reverse Characteristics

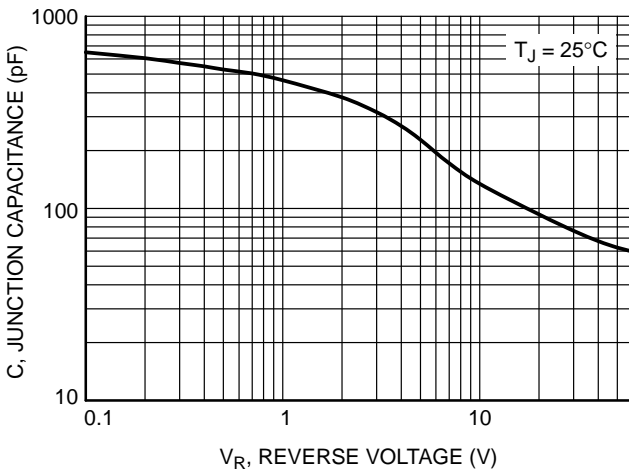

Figure 5. Typical Junction Capacitance

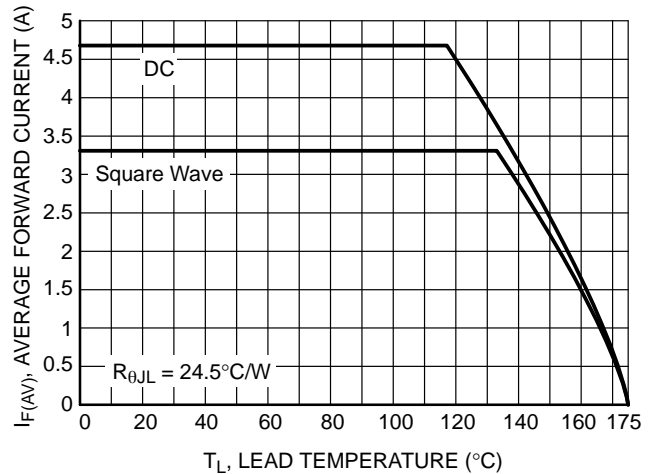

Figure 6. Current Derating

NRTSAF360, NRVTSAF360

TYPICAL CHARACTERISTICS

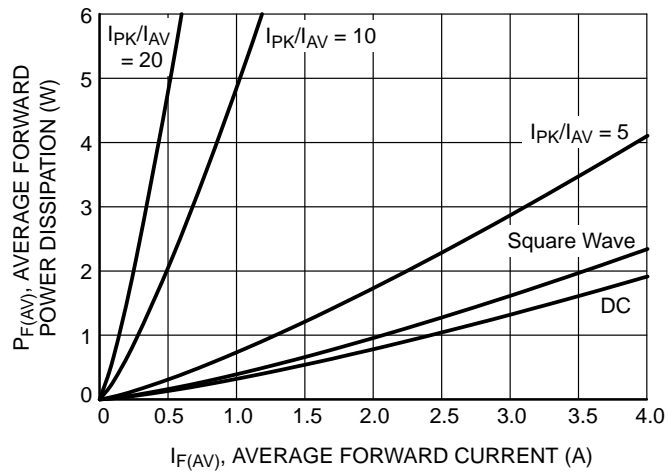

Figure 7. Forward Power Dissipation

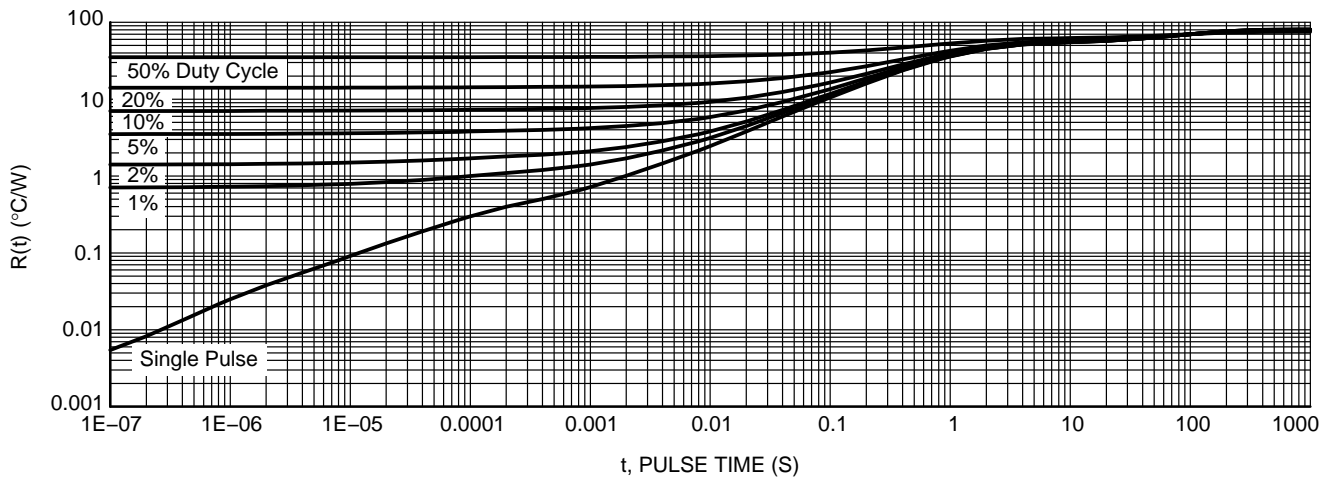
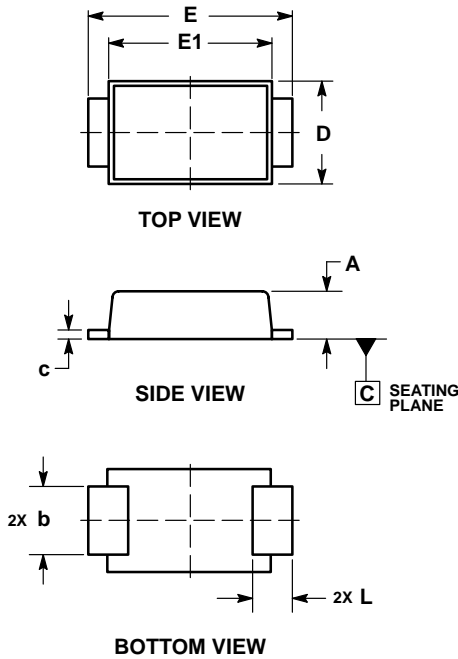

Figure 8. Typical Transient Thermal Response Characteristics, Junction-to-Ambient

NRTSAF360, NRVTSAF360

PACKAGE DIMENSIONS

SMA-FL
CASE 403AA
ISSUE O



NOTES:

1. DIMENSIONING AND TOLERANCING PER ASME Y14.5M, 1994.
2. CONTROLLING DIMENSION: MILLIMETERS.

MILLIMETERS		
DIM	MIN	MAX
A	0.90	1.10
b	1.25	1.65
c	0.15	0.30
D	2.40	2.80
E	4.80	5.40
E1	4.00	4.60
L	0.70	1.10

RECOMMENDED SOLDER FOOTPRINT*

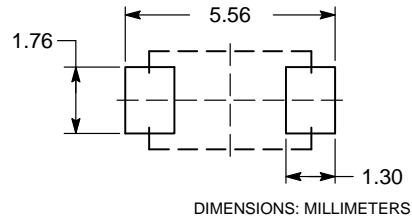

*For additional information on our Pb-Free strategy and soldering details, please download the ON Semiconductor Soldering and Mounting Techniques Reference Manual, SOLDERRM/D.

ON Semiconductor and are trademarks of Semiconductor Components Industries, LLC dba ON Semiconductor or its subsidiaries in the United States and/or other countries. ON Semiconductor owns the rights to a number of patents, trademarks, copyrights, trade secrets, and other intellectual property. A listing of ON Semiconductor's product/patent coverage may be accessed at www.onsemi.com/site/pdf/Patent-Marking.pdf. ON Semiconductor reserves the right to make changes without further notice to any products herein. ON Semiconductor makes no warranty, representation or guarantee regarding the suitability of its products for any particular purpose, nor does ON Semiconductor assume any liability arising out of the application or use of any product or circuit, and specifically disclaims any and all liability, including without limitation special, consequential or incidental damages. Buyer is responsible for its products and applications using ON Semiconductor products, including compliance with all laws, regulations and safety requirements or standards, regardless of any support or applications information provided by ON Semiconductor. "Typical" parameters which may be provided in ON Semiconductor data sheets and/or specifications can and do vary in different applications and actual performance may vary over time. All operating parameters, including "Typicals" must be validated for each customer application by customer's technical experts. ON Semiconductor does not convey any license under its patent rights nor the rights of others. ON Semiconductor products are not designed, intended, or authorized for use as a critical component in life support systems or any FDA Class 3 medical devices or medical devices with a same or similar classification in a foreign jurisdiction or any devices intended for implantation in the human body. Should Buyer purchase or use ON Semiconductor products for any such unintended or unauthorized application, Buyer shall indemnify and hold ON Semiconductor and its officers, employees, subsidiaries, affiliates, and distributors harmless against all claims, costs, damages, and expenses, and reasonable attorney fees arising out of, directly or indirectly, any claim of personal injury or death associated with such unintended or unauthorized use, even if such claim alleges that ON Semiconductor was negligent regarding the design or manufacture of the part. ON Semiconductor is an Equal Opportunity/Affirmative Action Employer. This literature is subject to all applicable copyright laws and is not for resale in any manner.

PUBLICATION ORDERING INFORMATION

LITERATURE FULFILLMENT:

Literature Distribution Center for ON Semiconductor
19521 E. 32nd Pkwy, Aurora, Colorado 80011 USA
Phone: 303-675-2175 or 800-344-3860 Toll Free USA/Canada
Fax: 303-675-2176 or 800-344-3867 Toll Free USA/Canada
Email: orderlit@onsemi.com

N. American Technical Support: 800-282-9855 Toll Free
USA/Canada
Europe, Middle East and Africa Technical Support:
Phone: 421 33 790 2910
Japan Customer Focus Center
Phone: 81-3-5817-1050

ON Semiconductor Website: www.onsemi.com
Order Literature: <http://www.onsemi.com/orderlit>

For additional information, please contact your local Sales Representative