

Pb Free Plating Product

MURB1620CTG/MURB1630CTG/MURB1640CTG/MURB1660CTG



16.0 Ampere Surface Mount Dual Common Cathode Ultra Fast Recovery Rectifier Diodes

Features

- ★ Matured GPP Technology
- ★ Good Soft Recovery Characteristics
- ★ Ideally Suited for Automatic Assembly
- ★ Low Forward Voltage
- ★ High Surge Current Capability
- ★ Low Leakage Current

Applications

- ★ Freewheeling, Snubber, Clamp
- ★ Inversion Welder
- ★ PFC&Transformer Secondary Rectifier
- ★ Plating Power Supply
- ★ Ultrasonic Cleaner and Welder
- ★ Converter & Chopper
- ★ UPS/LED SMPS/HID

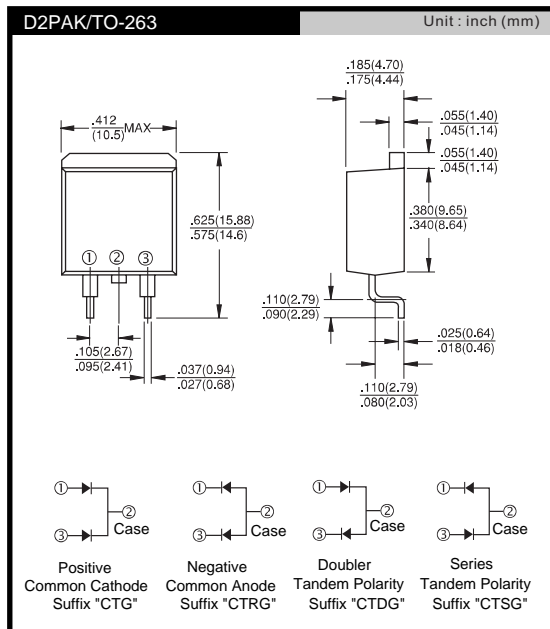

Maximum Ratings and Electrical Characteristics @T_A=25°C unless otherwise specified

Single Phase, half wave, 60Hz, resistive or inductive load. For capacitive load, derate current by 20%.

Characteristic	Symbol	MURB1620CTG	MURB1630CTG	MURB1640CTG	MURB1660CTG	Unit
Peak Repetitive Reverse Voltage	V _{RRM}					
Working Peak Reverse Voltage	V _{RWM}	200	300	400	600	V
DC Blocking Voltage	V _R					
RMS Reverse Voltage	V _{R(RMS)}	140	210	280	420	V
Average Rectified Output Current @T _C = 100°C	I _O			16.0 8.0		A
Non-Repetitive Peak Forward Surge Current 8.3ms Single Half Sine-Wave Superimposed on Rated Load (JEDEC Method)	I _{FSM}			150		A
Forward Voltage per diode @I _F = 8.0A	V _{FM}	0.98		1.3	1.7	V
Peak Reverse Current At Rated DC Blocking Voltage	I _{RM}			5.0 100		μA
Reverse Recovery Time (Note 1)	t _{rr}			35		nS
Typical Junction Capacitance (Note 2)	C _J	70		50		pF
Thermal Resistance Junction to Ambient (Note 3)	R _{JA}			30		°C/W
Thermal Resistance Junction to Lead (Note 3)	R _{JC}			1.5		
Operating and Storage Temperature Range	T _J , T _{STG}			-55 to +150		°C

Note: 1. Measured with I_F = 0.5A, I_R = 1.0A, I_{RR} = 0.25A.
 2. Measured at 1.0 MHz and applied reverse voltage of 4.0 V DC.
 3. Mounted on PCB with minimum recommended pad sizes per diode.

RATINGS AND CHARACTERISTICS CURVES
($T_A=25^\circ\text{C}$ unless otherwise noted)

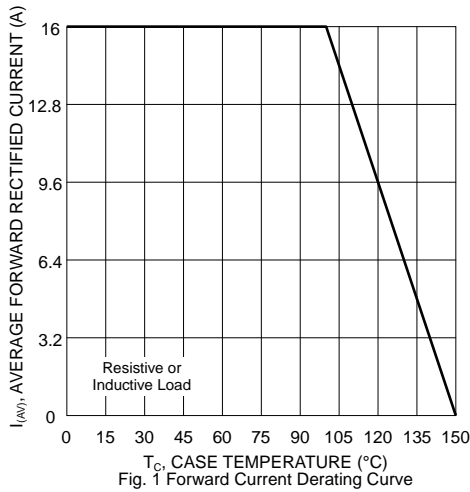

Fig. 1 Forward Current Derating Curve

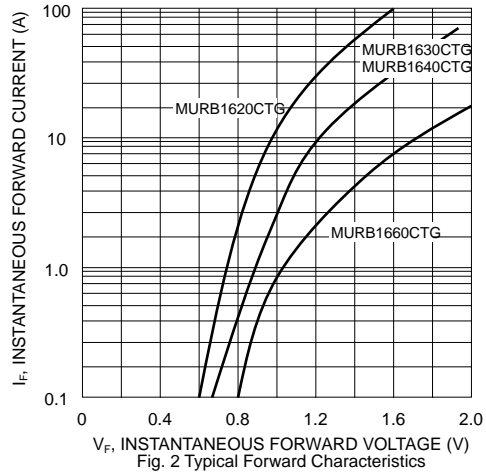

Fig. 2 Typical Forward Characteristics

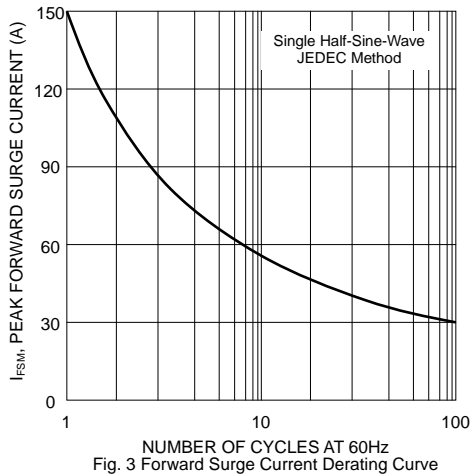

Fig. 3 Forward Surge Current Derating Curve

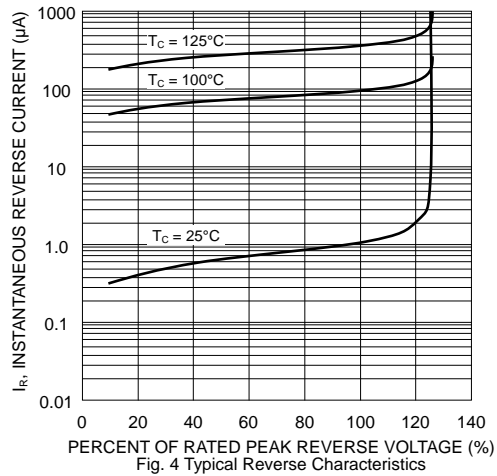

Fig. 4 Typical Reverse Characteristics

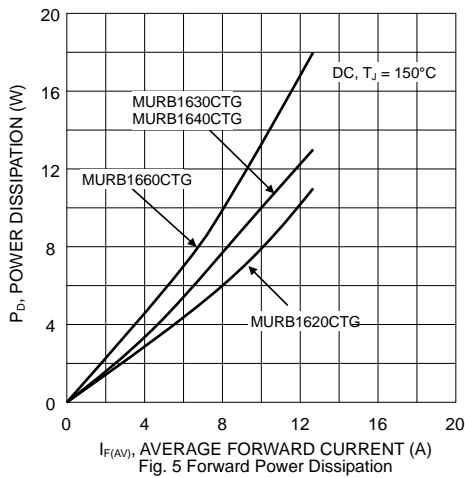

Fig. 5 Forward Power Dissipation

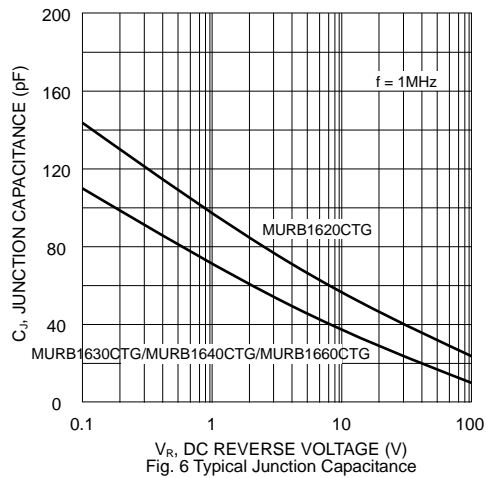

Fig. 6 Typical Junction Capacitance