

MSD42WT1G, NSVMSD42WT1G

NPN High Voltage Transistors

This NPN Silicon Planar Transistor is designed for general purpose amplifier applications. This device is housed in the SC-70/SOT-323 package which is designed for low power surface mount applications.

Features

- These Devices are Pb-Free, Halogen Free and are RoHS Compliant
- NSV Prefix for Automotive and Other Applications Requiring Unique Site and Control Change Requirements; AEC-Q101 Qualified and PPAP Capable

MAXIMUM RATINGS ($T_A = 25^\circ\text{C}$)

Rating	Symbol	Value	Unit
Collector-Base Voltage	$V_{(BR)CBO}$	300	V
Collector-Emitter Voltage	$V_{(BR)CEO}$	300	V
Emitter-Base Voltage	$V_{(BR)EBO}$	6.0	V
Collector Current – Continuous	I_C	150	mA

THERMAL CHARACTERISTICS

Rating	Symbol	Max	Unit
Power Dissipation (Note 1)	P_D	450	mW
Thermal Resistance, Junction-to-Ambient (Note 1)	$R_{\theta JA}$	274	$^\circ\text{C}/\text{W}$
Junction and Storage Temperature Range	T_J, T_{stg}	-55 to +150	$^\circ\text{C}$

Stresses exceeding Maximum Ratings may damage the device. Maximum Ratings are stress ratings only. Functional operation above the Recommended Operating Conditions is not implied. Extended exposure to stresses above the Recommended Operating Conditions may affect device reliability.

ELECTRICAL CHARACTERISTICS

Characteristic	Symbol	Min	Max	Unit
Collector-Emitter Breakdown Voltage ($I_C = 1.0\text{ mA}, I_B = 0$)	$V_{(BR)CEO}$	300	-	V
Collector-Base Breakdown Voltage ($I_C = 100\ \mu\text{A}, I_E = 0$)	$V_{(BR)CBO}$	300	-	V
Emitter-Base Breakdown Voltage ($I_E = 100\ \mu\text{A}, I_C = 0$)	$V_{(BR)EBO}$	6.0	-	V
Collector-Base Cutoff Current ($V_{CB} = 200\text{ V}, I_E = 0$)	I_{CBO}	-	0.1	μA
Emitter-Base Cutoff Current ($V_{EB} = 6.0\text{ V}, I_B = 0$)	I_{EBO}	-	0.1	μA
DC Current Gain (Note 2) ($V_{CE} = 10\text{ V}, I_C = 1.0\text{ mA}$) ($V_{CE} = 10\text{ V}, I_C = 30\text{ mA}$)	h_{FE1} h_{FE2}	25 40	- -	-
Collector-Emitter Saturation Voltage (Note 2) ($I_C = 20\text{ mA}, I_B = 2.0\text{ mA}$)	$V_{CE(sat)}$	-	0.5	V

1. FR-4 @ 10 mm², 1 oz. Copper traces.
2. Pulse Test: Pulse Width $\leq 300\ \mu\text{s}$, D.C. $\leq 2\%$.



ON Semiconductor®

<http://onsemi.com>

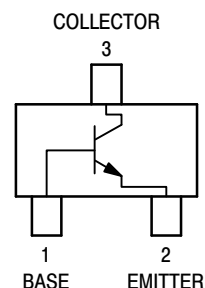

SC-70 (SOT-323)
CASE 419
STYLE 3

MARKING DIAGRAM

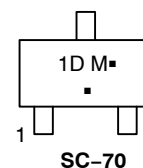

1D = Specific Device Code
M = Date Code
▪ = Pb-Free Package
(Note: Microdot may be in either location)

ORDERING INFORMATION

Device	Package	Shipping [†]
MSD42WT1G	SC-70 (Pb-Free)	3000 / Tape & Reel
NSVMSD42WT1G	SC-70 (Pb-Free)	3000 / Tape & Reel

[†]For information on tape and reel specifications, including part orientation and tape sizes, please refer to our Tape and Reel Packaging Specifications Brochure, BRD8011/D.

MSD42WT1G, NSVMSD42WT1G

TYPICAL CHARACTERISTICS

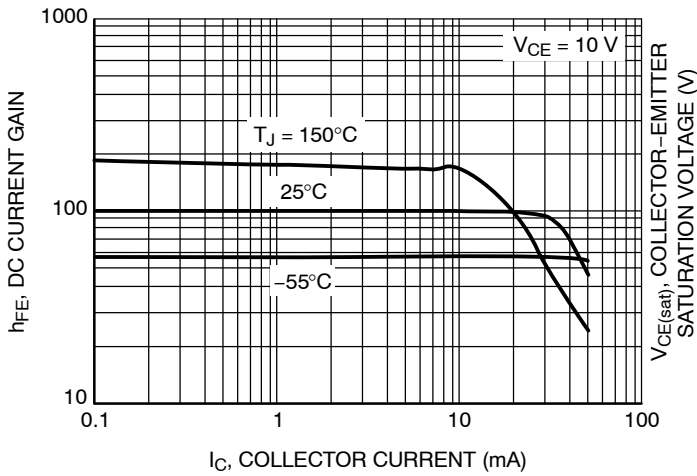

Figure 1. DC Current Gain

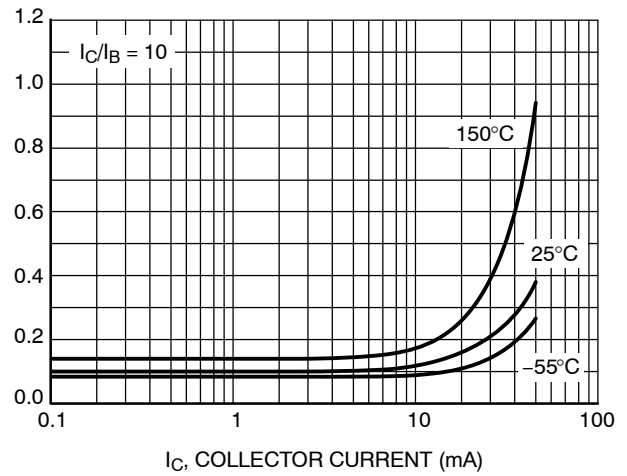

Figure 2. Collector-Emitter Saturation Voltage vs. Collector Current

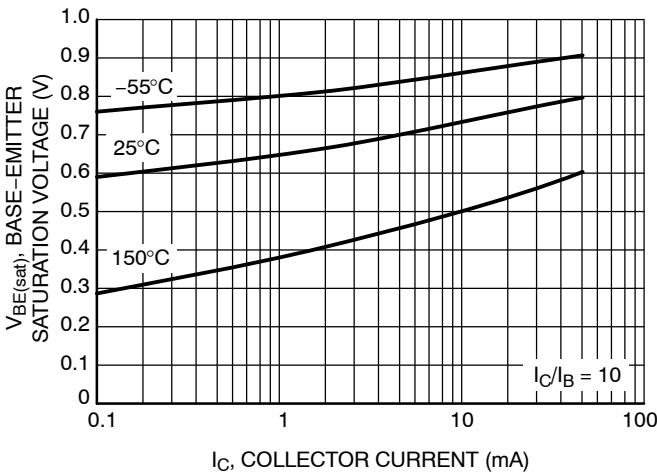

Figure 3. Base-Emitter Saturation Voltage vs. Collector Current

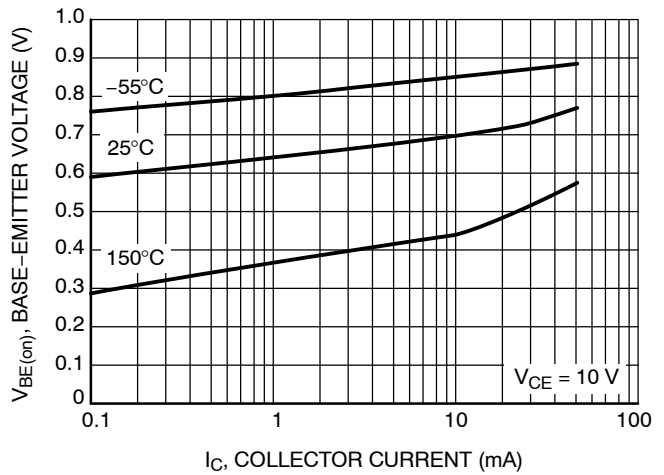

Figure 4. Base-Emitter On Voltage vs. Collector Current

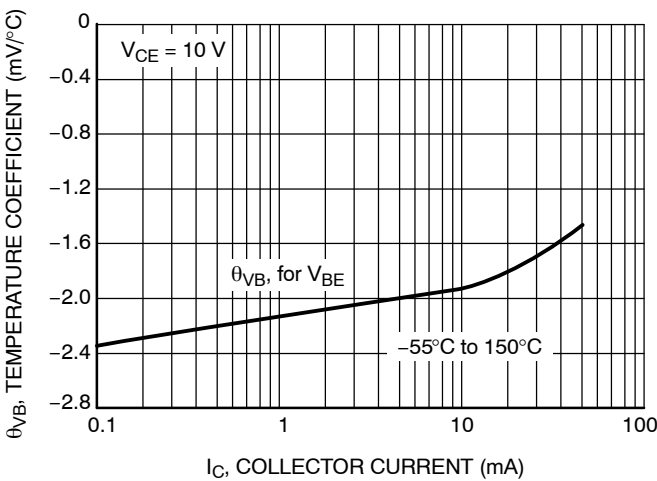

Figure 5. Base-Emitter Temperature Coefficient

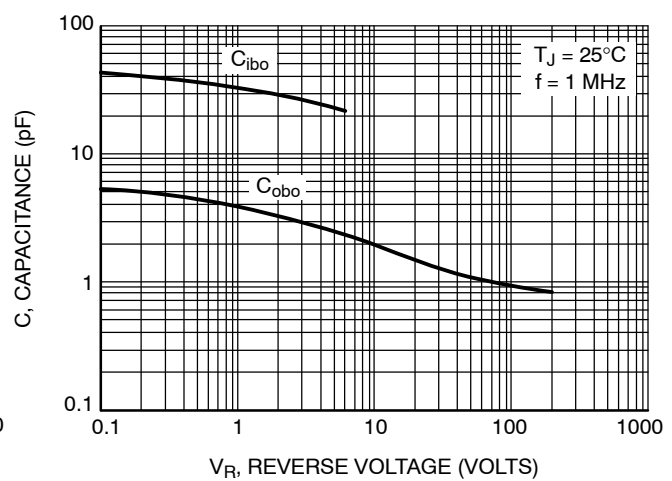

Figure 6. Capacitance

MSD42WT1G, NSVMSD42WT1G

TYPICAL CHARACTERISTICS

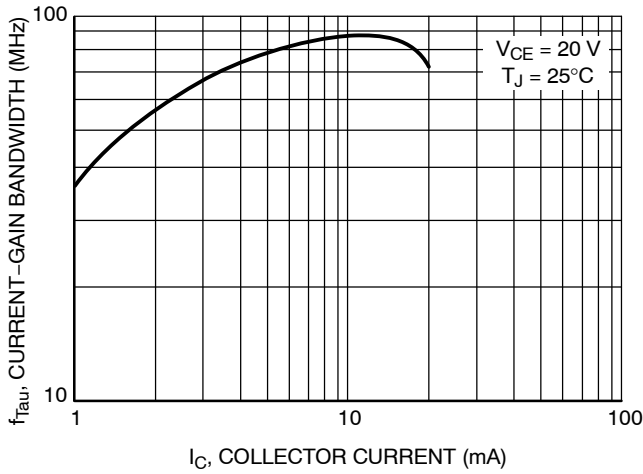

Figure 7. Current-Gain — Bandwidth Product

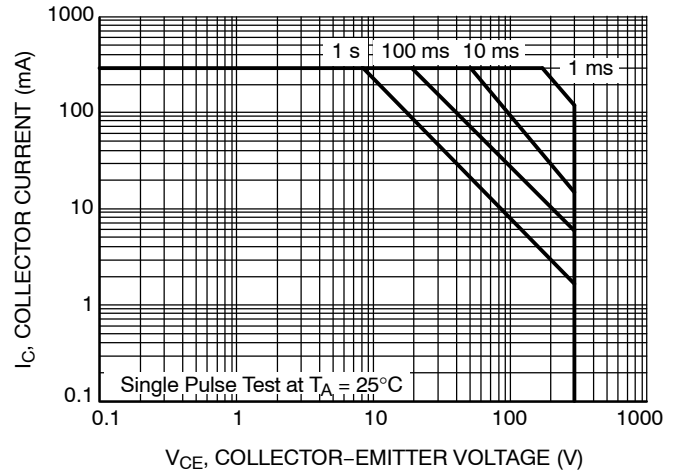

Figure 8. Safe Operating Area

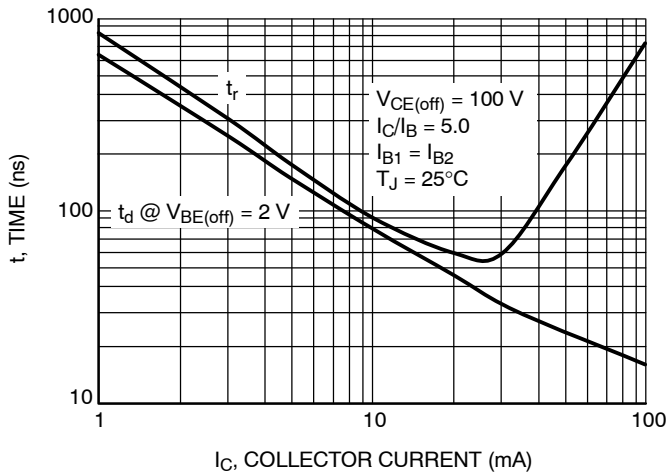

Figure 9. Turn-On Time

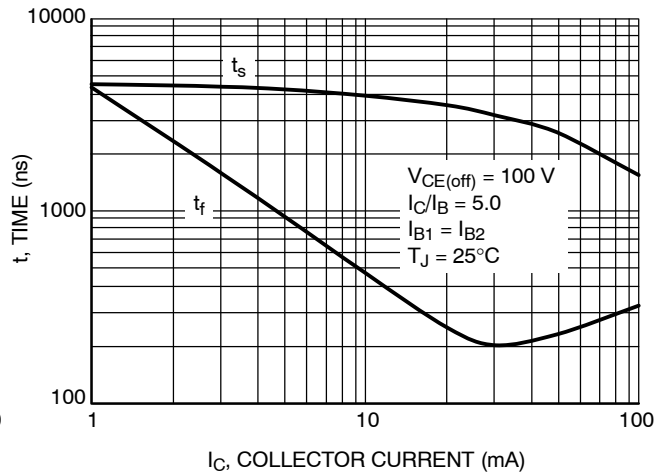
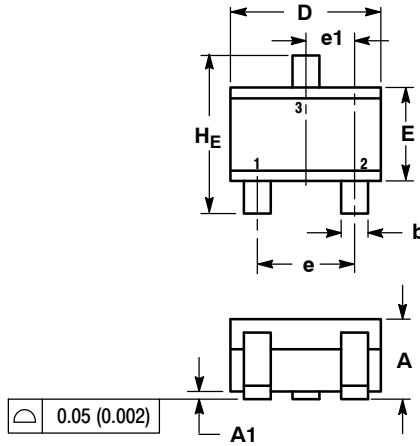

Figure 10. Turn-Off Time

MSD42WT1G, NSVMSD42WT1G

PACKAGE DIMENSIONS

SC-70 (SOT-323)
CASE 419-04
ISSUE N



NOTES:

1. DIMENSIONING AND TOLERANCING PER ANSI Y14.5M, 1982.
2. CONTROLLING DIMENSION: INCH.

DIM	MILLIMETERS			INCHES		
	MIN	NOM	MAX	MIN	NOM	MAX
A	0.80	0.90	1.00	0.032	0.035	0.040
A1	0.00	0.05	0.10	0.000	0.002	0.004
A2	0.70 REF			0.028 REF		
b	0.30	0.35	0.40	0.012	0.014	0.016
c	0.10	0.18	0.25	0.004	0.007	0.010
D	1.80	2.10	2.20	0.071	0.083	0.087
E	1.15	1.24	1.35	0.045	0.049	0.053
e	1.20	1.30	1.40	0.047	0.051	0.055
e1	0.65 BSC			0.026 BSC		
L	0.20	0.38	0.56	0.008	0.015	0.022
HE	2.00	2.10	2.40	0.079	0.083	0.095

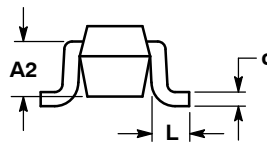

STYLE 3:

1. BASE
2. EMITTER
3. COLLECTOR

SOLDERING FOOTPRINT*

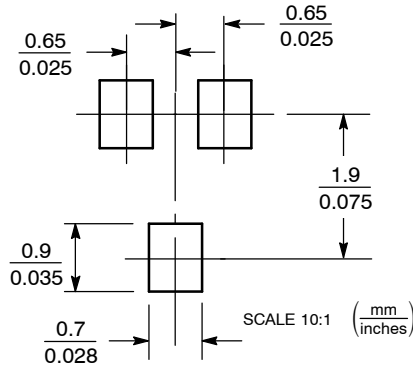

*For additional information on our Pb-Free strategy and soldering details, please download the ON Semiconductor Soldering and Mounting Techniques Reference Manual, SOLDERRM/D.

ON Semiconductor and are registered trademarks of Semiconductor Components Industries, LLC (SCILLC). SCILLC owns the rights to a number of patents, trademarks, copyrights, trade secrets, and other intellectual property. A listing of SCILLC's product/patent coverage may be accessed at www.onsemi.com/site/pdf/Patent-Marking.pdf. SCILLC reserves the right to make changes without further notice to any products herein. SCILLC makes no warranty, representation or guarantee regarding the suitability of its products for any particular purpose, nor does SCILLC assume any liability arising out of the application or use of any product or circuit, and specifically disclaims any and all liability, including without limitation special, consequential or incidental damages. "Typical" parameters which may be provided in SCILLC data sheets and/or specifications can and do vary in different applications and actual performance may vary over time. All operating parameters, including "Typicals" must be validated for each customer application by customer's technical experts. SCILLC does not convey any license under its patent rights nor the rights of others. SCILLC products are not designed, intended, or authorized for use as components in systems intended for surgical implant into the body, or other applications intended to support or sustain life, or for any other application in which the failure of the SCILLC product could create a situation where personal injury or death may occur. Should Buyer purchase or use SCILLC products for any such unintended or unauthorized application, Buyer shall indemnify and hold SCILLC and its officers, employees, subsidiaries, affiliates, and distributors harmless against all claims, costs, damages, and expenses, and reasonable attorney fees arising out of, directly or indirectly, any claim of personal injury or death associated with such unintended or unauthorized use, even if such claim alleges that SCILLC was negligent regarding the design or manufacture of the part. SCILLC is an Equal Opportunity/Affirmative Action Employer. This literature is subject to all applicable copyright laws and is not for resale in any manner.

PUBLICATION ORDERING INFORMATION

LITERATURE FULFILLMENT:
 Literature Distribution Center for ON Semiconductor
 P.O. Box 5163, Denver, Colorado 80217 USA
Phone: 303-675-2175 or 800-344-3860 Toll Free USA/Canada
Fax: 303-675-2176 or 800-344-3867 Toll Free USA/Canada
Email: orderlit@onsemi.com

N. American Technical Support: 800-282-9855 Toll Free
 USA/Canada
Europe, Middle East and Africa Technical Support:
 Phone: 421 33 790 2910
Japan Customer Focus Center
 Phone: 81-3-5817-1050

ON Semiconductor Website: www.onsemi.com
Order Literature: <http://www.onsemi.com/orderlit>

For additional information, please contact your local Sales Representative