

Small Signal Product

350mW, PNP Small Signal Transistor

FEATURES

- Epitaxial planar die construction
- Surface device type mounting
- Moisture sensitivity level 1
- Matte Tin (Sn) lead finish with Nickel (Ni) underplate
- Pb free version and RoHS compliant
- Packing code with suffix "G" means green compound (halogen-free)

SOT-23

MECHANICAL DATA

- Case: SOT- 23, molded plastic
- Terminal: Matte tin plated, lead free, solderable per MIL-STD-202, Method 208 guaranteed
- High temperature soldering guaranteed: 260°C/10s
- Weight: 0.008g (approximately)
- Marking Code: 2A

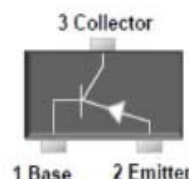

MAXIMUM RATINGS AND ELECTRICAL CHARACTERISTICS (T _A =25°C unless otherwise noted)			
PARAMETER	SYMBOL	VALUE	UNIT
Power Dissipation	P _D	350	mW
Collector-Base Voltage	V _{CB0}	-40	V
Collector-Emitter Voltage	V _{CEO}	-40	V
Emitter-Base Voltage	V _{EBO}	-5	V
Collector Current	I _C	-200	mA
Thermal Resistance Junction-Ambient	R _{θJA}	357	°C/W
Junction and Storage Temperature Range	T _J , T _{STG}	-55 to + 150	°C

Notes:1. Valid provided that electrodes are kept at ambient temperature

PARAMETER	SYMBOL	MIN	MAX	UNIT
Collector-Base Breakdown Voltage I _C = 10 μA I _E = 0	V _{(BR)CBO}	-40	-	V
Collector-Emitter Breakdown Voltage I _C = -1 mA I _B = 0	V _{(BR)CEO}	-40	-	V
Emitter-Base Breakdown Voltage I _E = -10 μA I _C = 0	V _{(BR)EBO}	-5	-	V
Collector Base Cut-off Current V _{CB} = -40 V	I _{CBO}	-	-100	nA
Emitter Base Cut-off Current V _{EB} = -6 V	I _{EBO}	-	-50	nA
DC Current Gain	h _{FE}	V _{CE} = -1 V I _C = -0.1 mA	60	300
		V _{CE} = -1 V I _C = -1 mA	80	
		V _{CE} = -1 V I _C = -10 mA	100	
		V _{CE} = -1 V I _C = -50 mA	60	
		V _{CE} = -1 V I _C = -100 mA	30	
Collector-Emitter Saturation Voltage I _C = -10 mA I _B = -1 mA I _C = -50 mA I _B = -5 mA	V _{CE(sat)}	-	-0.25	V
		-	-0.4	
Base-Emitter Saturation Voltage I _C = -10 mA I _B = -1 mA I _C = -50 mA I _B = -5 mA	V _{BE(sat)}	-0.65	-0.85	V
		-	-0.95	
Gain-Bandwidth Product V _{CE} = -20 V I _C = -10 mA f = 100MHz	f _T	250	-	MHz
Output Capacitance V _{CB} = -5 V I _E = 0 f = 1MHz	C _{obo}	-	4.5	pF
Delay time V _{CC} = -3 V V _{BE} = -0.5 V I _C = -10 mA	t _d	-	35	ns
Rise time I _{B1} = -1.0 mA	t _r	-	35	ns
Storage time V _{CC} = -3 V I _C = -10 mA	t _s	-	225	ns
Fall time I _{B1} = I _{B2} = -1.0 mA	t _f	-	75	ns

Small Signal Product

RATINGS AND CHARACTERISTICS CURVES

($T_A=25^\circ\text{C}$ unless otherwise noted)

Fig. 1 Capacitance

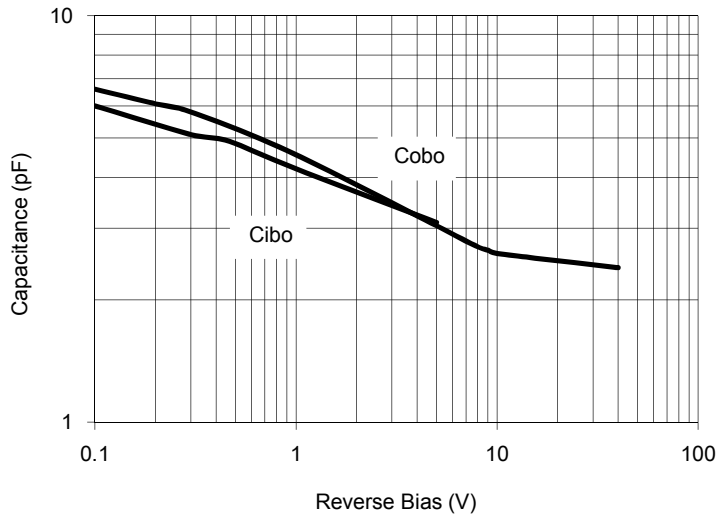

Fig. 2 Charge Data

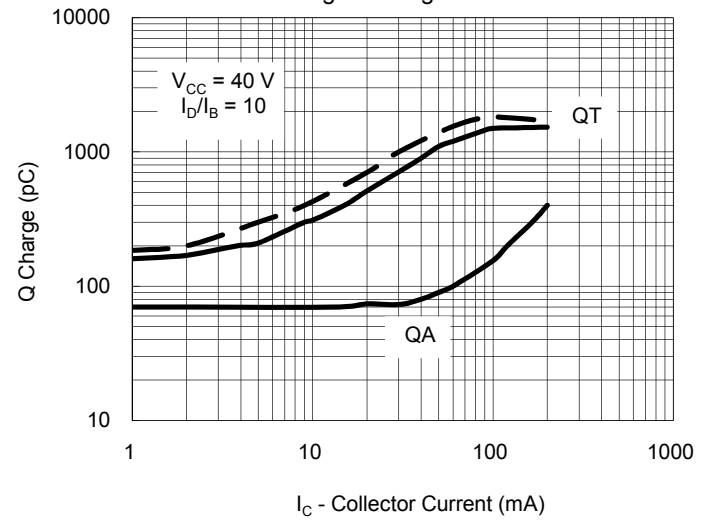

Fig. 3 Turn - On Time

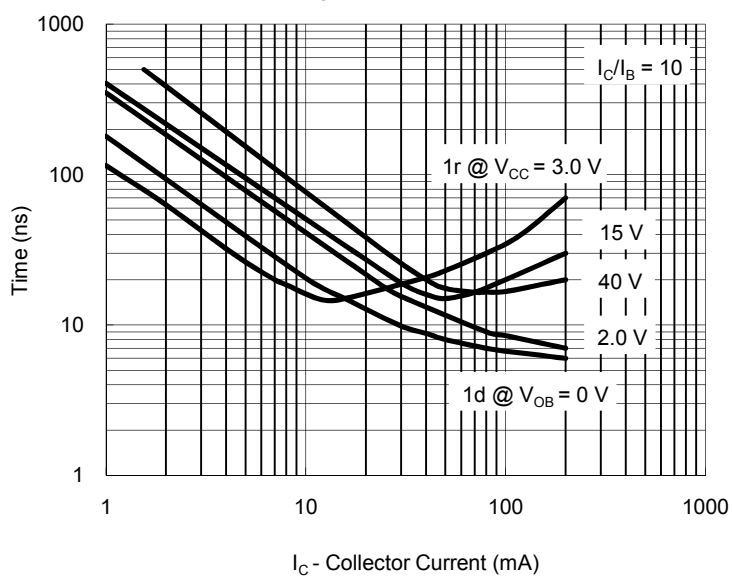

Fig. 4 Fall Time

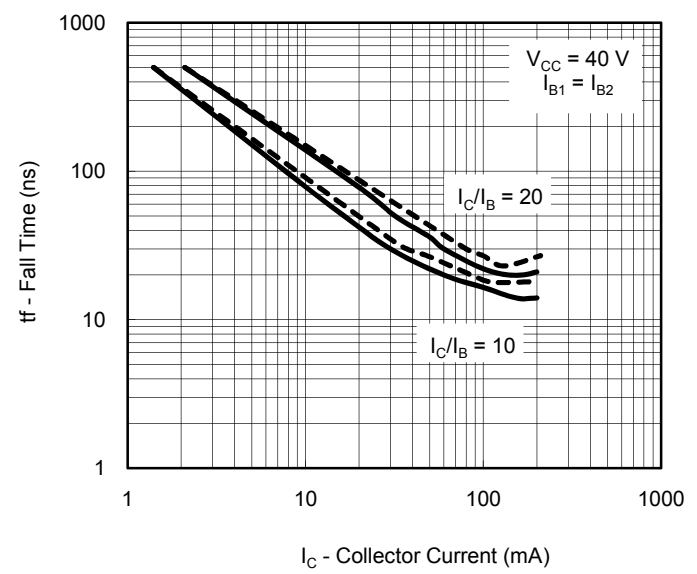

Fig. 5 Noise Figure VS. Frequency

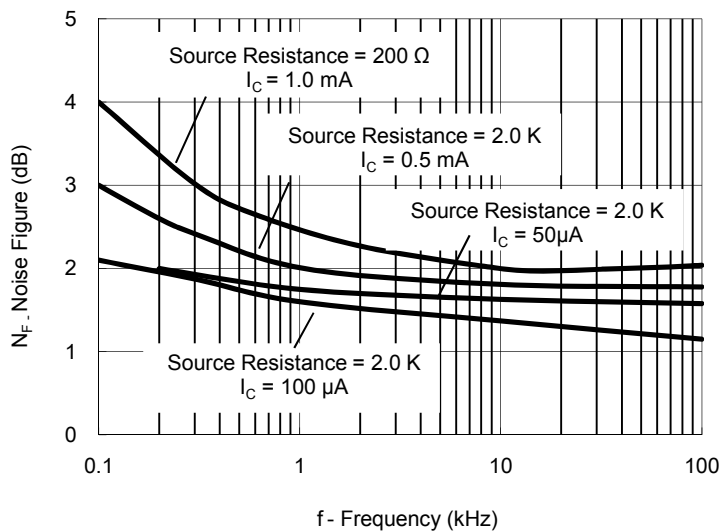
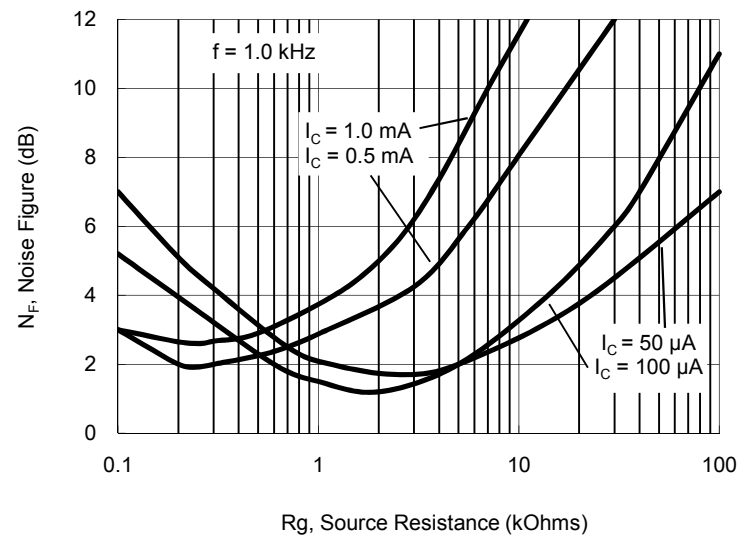

Fig. 6 Noise Figure VS. Source



Small Signal Product

h Parameters ($V_{CE} = -10 V_{DC}$, $f = 1.0 \text{ kHz}$, $T_A = 25^\circ\text{C}$)

Fig. 7 Current Gain

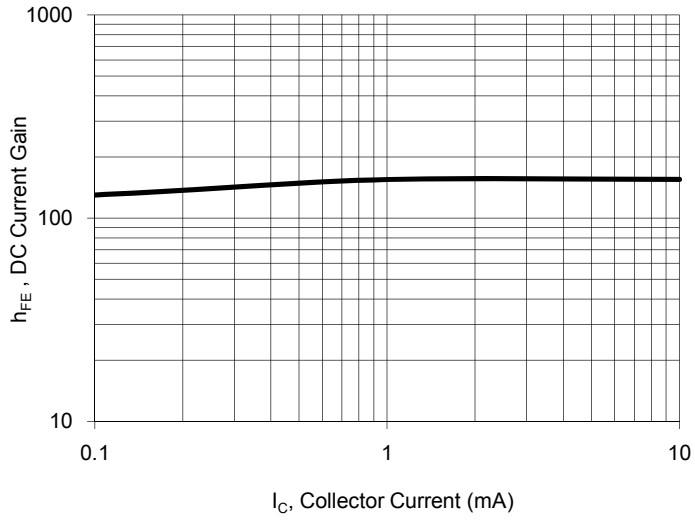

Fig. 8 Output Admittance

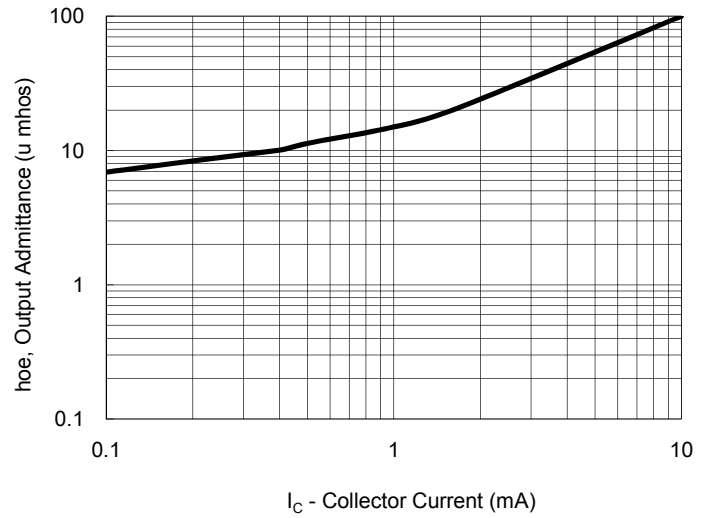

Fig. 9 Input Impedance

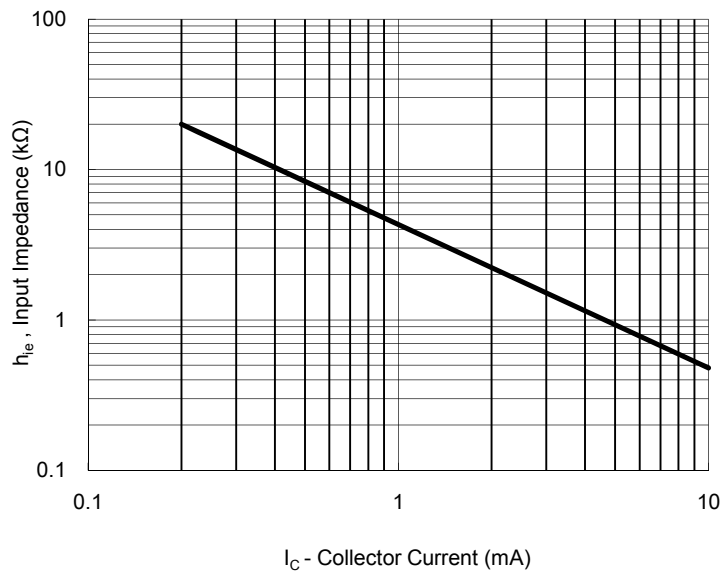

Fig. 10 Voltage Feedback Ratio

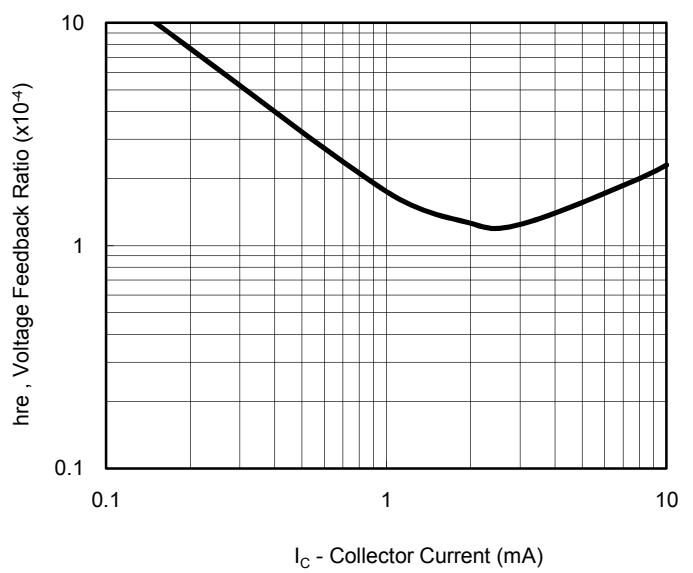

Fig. 11 "ON" Voltages

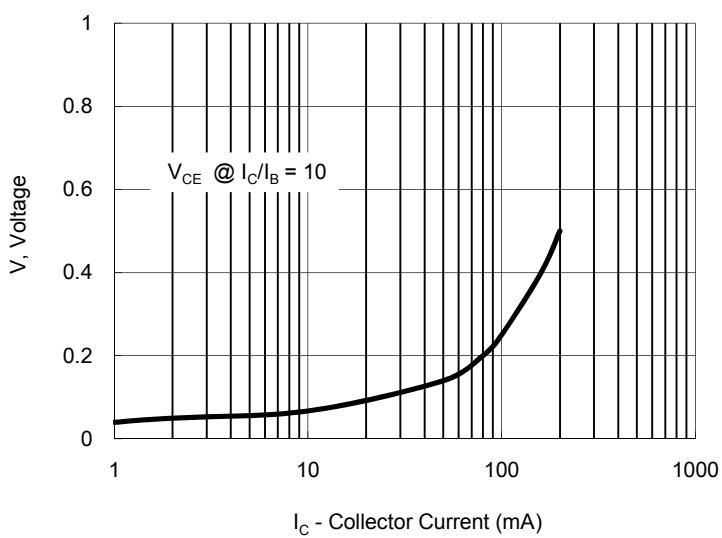
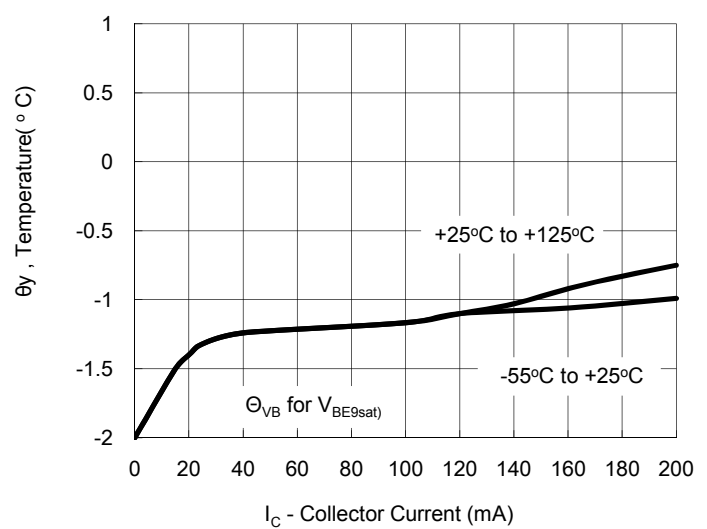

Fig. 12 Temperature Coefficients



Small Signal Product

ORDERING INFORMATION					
PART NO.	PART NO. SUFFIX (Note 1)	PACKING CODE	PACKING CODE SUFFIX	PACKAGE	PACKING
MMBT3906	-xx	RF	G	SOT-23	3K / 7" Reel
		R5			10K / 13" Reel

Note 1: Part No. Suffix „-xx “ would be used for special requirement

EXAMPLE					
PREFERRED P/N	PART NO.	PART NO. SUFFIX	PACKING CODE	PACKING CODE SUFFIX	DESCRIPTION
MMBT3906 RF	MMBT3906		RF		Multiple manufacture source
MMBT3906 RFG	MMBT3906		RF	G	Multiple manufacture source Green compound
MMBT3906-D0 RFG	MMBT3906	-D0	RF	G	Defined manufacture source Green compound
MMBT3906-B0 RFG	MMBT3906	-B0	RF	G	Defined manufacture source Green compound

PACKAGE OUTLINE DIMENSIONS

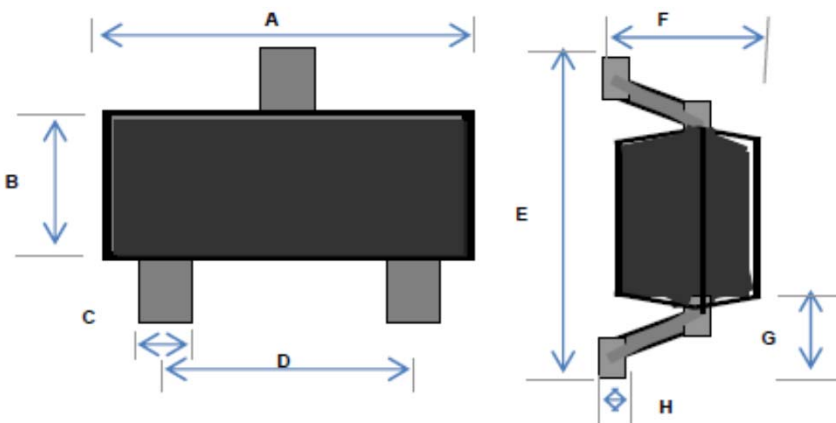

DIM.	Unit(mm)		Unit(inch)	
	Min	Max	Min	Max
A	2.70	3.10	0.106	0.122
B	1.10	1.50	0.043	0.059
C	0.30	0.51	0.012	0.020
D	1.78	2.04	0.070	0.080
E	2.10	2.64	0.083	0.104
F	0.89	1.30	0.035	0.051
G	0.55 REF		0.022 REF	
H	0.10 REF		0.004 REF	

SUGGEST PAD LAYOUT

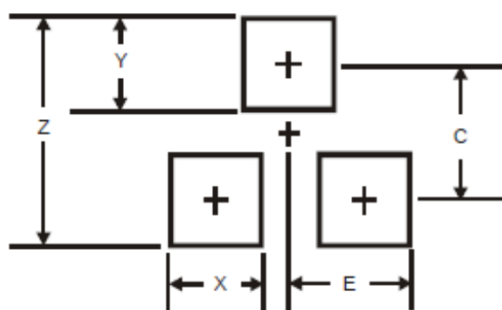

DIM	Unit (mm)	Unit (inch)
	TYP	TYP
Z	2.8	0.11
X	0.7	0.03
Y	0.9	0.04
C	1.9	0.07
E	1.0	0.04

Notice

Specifications of the products displayed herein are subject to change without notice. TSC or anyone on its behalf, assumes no responsibility or liability for any errors or inaccuracies.

Information contained herein is intended to provide a product description only. No license, express or implied, to any intellectual property rights is granted by this document. Except as provided in TSC's terms and conditions of sale for such products, TSC assumes no liability whatsoever, and disclaims any express or implied warranty, relating to sale and/or use of TSC products including liability or warranties relating to fitness for a particular purpose, merchantability, or infringement of any patent, copyright, or other intellectual property right.

The products shown herein are not designed for use in medical, life-saving, or life-sustaining applications. Customers using or selling these products for use in such applications do so at their own risk and agree to fully indemnify TSC for any damages resulting from such improper use or sale.