

MGA-53543

50 MHz to 6 GHz High Linear Amplifier



Data Sheet

Description

Avago Technologies's MGA-53543 is a high dynamic range low noise amplifier MMIC housed in a 4-lead SC-70 (SOT-343) surface mount plastic package.

The combination of high linearity, low noise figure and high gain makes the MGA-53543 ideal for cellular/PCS/W-CDMA base stations, Wireless LAN, WLL and other systems in the 50 MHz to 6 GHz frequency range.

MGA-53543 is especially ideal for Cellular/PCS/W-CDMA basestation applications. With high IP3 and low noise figure, the MGA-53543 may be utilized as a driver amplifier in the transmit chain and as a second stage LNA in the receive chain.

Surface Mount Package SOT-343 / 4-lead SC70

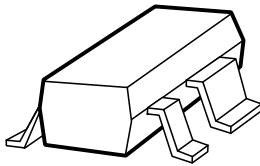

Pin Connections and Package Marking

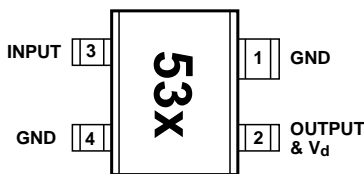

Note:
Top View. Package marking provides orientation and identification.
"53" = Device Code
"x" = Date code character identifies month of manufacture.



Attention: Observe precautions for handling electrostatic sensitive devices.
ESD Machine Model (Class A)
ESD Human Body Model (Class 1A)
Refer to Avago Application Note A004R: *Electrostatic Discharge Damage and Control.*

Features

- Lead-free Option Available
- Very high linearity at low DC bias power^[1]
- Low noise figure
- Advanced enhancement mode PHEMT technology
- Excellent uniformity in product specifications
- Low cost surface mount small plastic package SOT-343 (4-lead SC-70)
- Tape-and-Reel packaging option available

Specifications 1.9 GHz, 5V, 54 mA (typ)

- OIP3: 39 dBm
- Noise figure: 1.5 dB
- Gain: 15.4 dB
- P-1dB: 18.6 dBm

Applications

- Base station radio card
- High linearity LNA for base stations, WLL, WLAN, and other applications in the 50 MHz to 6 GHz range

Note:

1. The MGA-53543 has a superior LFOM of 15 dB. Linearity Figure of Merit (LFOM) is essentially OIP3 divided by DC bias power. There are few devices in the market that can match its combination of high linearity and low noise figure at the low DC bias power of 5V/54 mA.

Simplified Schematic

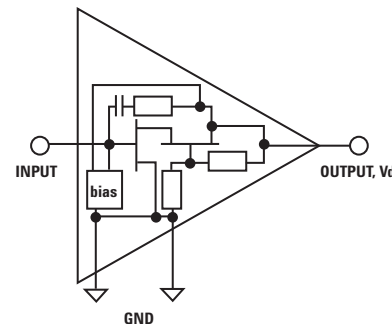

MGA-53543 Absolute Maximum Ratings^[1]

Symbol	Parameter	Units	Absolute Maximum
V_{in}	Maximum Input Voltage	V	0.8
V_d	Supply Voltage	V	5.5
P_d	Power Dissipation ^[2]	mW	400
P_{in}	CW RF Input Power	dBm	13
T_j	Junction Temperature	°C	150
T_{STG}	Storage Temperature	°C	-65 to 150

Thermal Resistance^[3]
 $(V_d=5.0V) \theta_{jc} = 130^{\circ}C/W$

Notes:

1. Operation of this device in excess of any of these limits may cause permanent damage.
2. Source lead temperature is 25°C. Derate 7.7mW/°C for $T_L > 98^{\circ}C$
3. Thermal resistance measured using 150°C Liquid Crystal Measurement Technique.

Electrical Specifications

$T_c = +25^{\circ}C$, $Z_o = 50 \Omega$, $V_d = 5V$, unless noted

Symbol	Parameter and Test Condition	Frequency	Units	Min.	Typ.	Max.	σ ^[3]
I_d	Current Drawn	N/A	mA	40	54	70	2.7
NF ^[1]	Noise Figure	2.4 GHz 1.9 GHz 0.9 GHz	dB		1.9 1.5 1.3	1.9	0.06
Gain ^[1]	Gain	2.4 GHz 1.9 GHz 0.9 GHz	dB	14	15.1 15.4 17.4	17.0	0.25
OIP3 ^[1,2]	Output Third Order Intercept Point	2.4 GHz 1.9 GHz 0.9 GHz	dBm	36	38.7 39.1 39.7		1.89
P1dB ^[1]	Output Power at 1 dB Gain Compression	2.4 GHz 1.9 GHz 0.9 GHz	dBm		18.3 18.6 19.3		
PAE ^[1]	Power Added Efficiency at P1dB	1.9 GHz 0.9 GHz	%		29.7 28.3		
RL _{in} ^[1]	Input Return Loss	2.4 GHz 1.9 GHz 0.9 GHz	dB		-12.7 -13.2 -11.1		
RL _{out} ^[1]	Output Return Loss	2.4 GHz 1.9 GHz 0.9 GHz	dB		-25.1 -14.3 -14.4		
ISOL ^[1]	Isolation $ S_{12} ^2$	1.9 GHz 0.9 GHz	dB		-23.4 -22.3		

Notes:

1. Measurements obtained from a test circuit described in Figure 1. Input and output tuners tuned for maximum OIP3 while keeping VSWR better than 2:1. Data corrected for board losses.
2. I) Output power level and frequency of two fundamental tones at 1.9 GHz: F1 = 5.49 dBm, F2 = 5.49 dBm, F1 = 1.905 GHz, and F2 = 1.915 GHz.
 II) Output power level and frequency of two fundamental tones at 900 MHz: F1 = -0.38 dBm, F2 = -0.38 dBm, F1 = 905 MHz, and F2 = 915 MHz.
3. Standard deviation data are based on at least 500 pieces sample size taken from 8 wafer lots. Future wafers allocated to this product may have nominal values anywhere between the upper and lower spec limits.

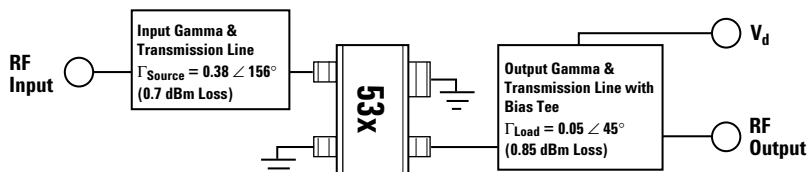

Figure 1. Block Diagram of 1.9 GHz Test Fixture.

MGA-53543 Typical Performance

All data measured at $T_c = 25^\circ\text{C}$, $V_d = 5\text{V}$ with input and output tuners tuned for maximum OIP3 while keeping VSWR better than 2:1 unless stated otherwise.

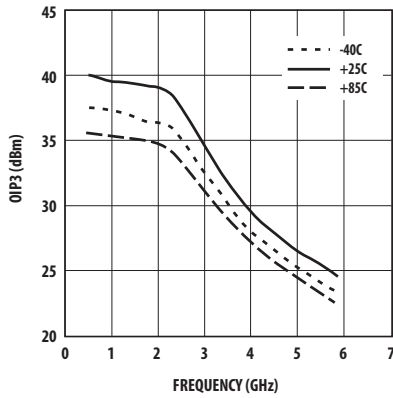

Figure 2. Output Third Order Intercept Point vs. Frequency and Temperature.

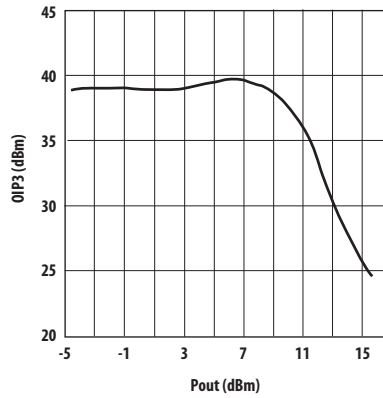

Figure 3. Output Third Order Intercept Point vs. Output Power at 2 GHz.

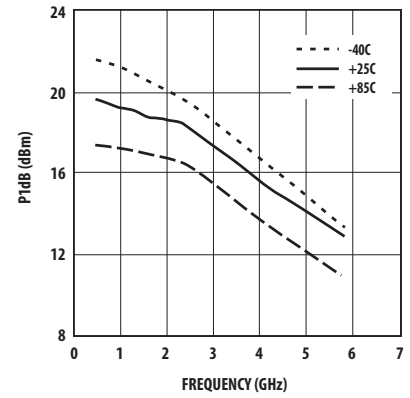

Figure 4. Output Power at 1dB Compression vs. Frequency and Temperature.

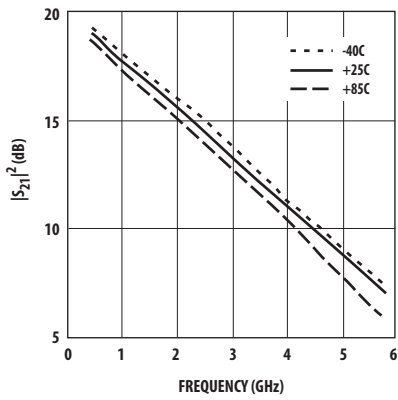

Figure 5. $|S_{21}|^2$ vs. Frequency and Temperature.

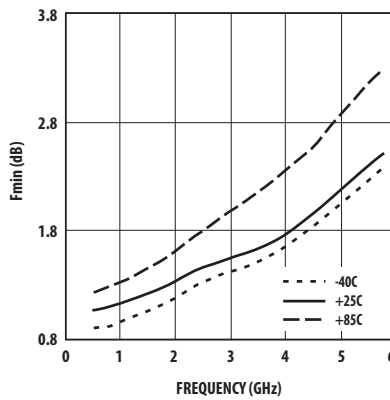

Figure 6. Fmin vs. Frequency and Temperature.

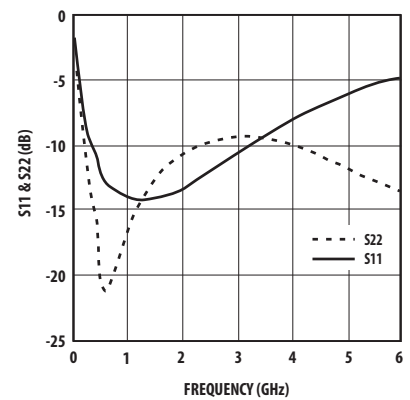

Figure 7. S11 and S22 (50) vs. Frequency.

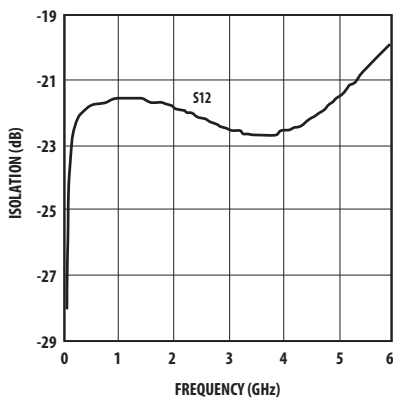

Figure 8. Isolation vs. Frequency.

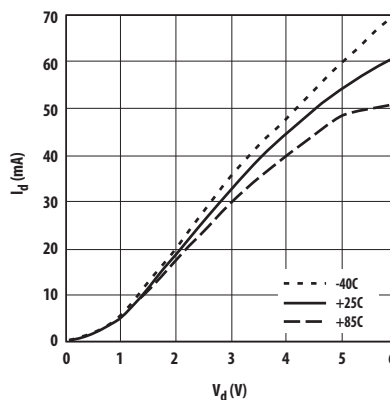

Figure 9. Current vs. Voltage and Temperature.

MGA-53543 Typical Scattering Parameters

$T_c = 25^\circ\text{C}$, $V_d = 5.0\text{V}$, $I_d = 54\text{ mA}$, $Z_o = 50\ \Omega$, (in ICM test fixture)

Freq (GHz)	S_{11} Mag.	S_{11} Ang.	S_{21} dB	S_{21} Mag.	S_{21} Ang.	S_{12} dB	S_{12} Mag.	S_{12} Ang.	S_{22} Mag.	S_{22} Ang.	K
0.05	0.823	-38.8	26.26	20.56	161.3	-27.96	0.04	59.7	0.72	-33	0.3
0.1	0.641	-66.7	24.39	16.584	148.9	-24.29	0.061	40.6	0.558	-61.5	0.4
0.2	0.439	-98.7	21.55	11.954	142.7	-22.50	0.075	22.9	0.344	-95.3	0.7
0.3	0.349	-116.8	20.14	10.165	141.8	-22.05	0.079	15.4	0.235	-118.3	0.9
0.4	0.305	-128.9	19.39	9.317	140.7	-21.94	0.08	11.2	0.176	-138.2	0.9
0.5	0.251	-135.6	18.92	8.826	139.3	-21.83	0.081	9	0.097	-167.4	1
0.6	0.233	-142.5	18.6	8.509	136.7	-21.72	0.082	7	0.087	159.7	1
0.7	0.22	-147.5	18.34	8.261	133.6	-21.72	0.082	5.4	0.094	131.8	1.1
0.8	0.212	-151.1	18.12	8.053	130.2	-21.72	0.082	4	0.11	110.7	1.1
0.9	0.207	-153.6	17.9	7.854	126.7	-21.62	0.083	2.8	0.129	95.4	1.1
1.0	0.201	-155.3	17.7	7.674	123	-21.62	0.083	1.7	0.148	84.1	1.1
1.1	0.198	-157.3	17.51	7.505	119.2	-21.62	0.083	0.7	0.169	74.8	1.1
1.2	0.196	-158.2	17.31	7.335	115.4	-21.62	0.083	-0.2	0.186	66.6	1.1
1.3	0.194	-158.4	17.1	7.165	111.6	-21.62	0.083	-1.1	0.203	59.6	1.1
1.4	0.195	-159.4	16.9	7	107.7	-21.62	0.083	-2	0.219	53.1	1.1
1.5	0.197	-160	16.7	6.836	103.9	-21.62	0.083	-2.8	0.235	47.6	1.1
1.6	0.199	-160.1	16.48	6.666	100.1	-21.72	0.082	-3.6	0.248	42.2	1.1
1.7	0.201	-160.5	16.26	6.498	96.3	-21.72	0.082	-4.3	0.261	37.1	1.1
1.8	0.205	-161.5	16.04	6.341	92.6	-21.72	0.082	-4.9	0.273	32.4	1.1
1.9	0.212	-162.6	15.82	6.179	88.9	-21.83	0.081	-5.6	0.283	28	1.2
2.0	0.216	-163.1	15.59	6.017	85.3	-21.83	0.081	-6.2	0.293	23.8	1.2
2.1	0.221	-164.8	15.36	5.862	81.7	-21.94	0.08	-6.7	0.301	19.8	1.2
2.2	0.229	-166.1	15.14	5.714	78.3	-21.94	0.08	-7.3	0.31	16	1.2
2.3	0.235	-167.2	14.9	5.56	74.7	-22.05	0.079	-7.6	0.316	12.3	1.2
2.4	0.241	-169.2	14.67	5.412	71.2	-22.16	0.078	-7.9	0.322	8.8	1.3
2.5	0.25	-171.4	14.43	5.265	67.8	-22.16	0.078	-8.2	0.327	5.5	1.3
3.0	0.293	176.8	13.28	4.611	51.5	-22.50	0.075	-8.6	0.338	-9.4	1.4
3.5	0.342	162.2	12.13	4.039	36.2	-22.73	0.073	-7.3	0.333	-22.6	1.5
4.0	0.394	148.2	10.99	3.544	21.6	-22.62	0.074	-5.3	0.313	-34.9	1.6
4.5	0.445	133.9	9.84	3.105	7.8	-22.27	0.077	-3.4	0.287	-48	1.6
5.0	0.497	121.6	8.7	2.721	-5.2	-21.51	0.084	-2.7	0.256	-62.1	1.6
5.5	0.534	109.9	7.56	2.388	-17.5	-20.72	0.092	-3.5	0.229	-77.8	1.6
6.0	0.565	99.5	6.46	2.105	-28.8	-19.83	0.102	-5.9	0.204	-94.1	1.5
6.5	0.595	88.2	5.38	1.857	-39.6	-18.94	0.113	-10.4	0.185	-108.7	1.5
7.0	0.615	77.5	4.31	1.643	-49.8	-18.27	0.122	-16	0.162	-120.2	1.5
7.5	0.635	65.2	3.3	1.462	-59.6	-17.72	0.13	-22.1	0.127	-128.8	1.6
8.0	0.662	53.9	2.29	1.301	-68.8	-17.27	0.137	-28.2	0.084	-132.9	1.6
8.5	0.682	43.4	1.37	1.171	-77.6	-16.77	0.145	-34.2	0.033	-145.4	1.6
9.0	0.715	32.3	0.45	1.053	-86	-16.31	0.153	-40.9	0.028	57.9	1.6
9.5	0.752	24.9	-0.31	0.965	-93.5	-15.86	0.161	-47.5	0.081	51.3	1.5
10.0	0.754	16	-1.12	0.879	-101.7	-15.55	0.167	-55.3	0.129	50.1	1.6

MGA-53543 Typical Noise Parameters

$T_c = 25^\circ\text{C}$, $V_d = 5.0\text{V}$, $I_d = 54\text{ mA}$, $Z_0 = 50\ \Omega$, (in ICM test fixture)

Freq (GHz)	F_{\min} (dB)	Γ_{opt} Mag	Γ_{opt} Ang	R_n/Z_0	G_a (dB)
0.5	1.07	0.108	156.5	0.1	19.13
0.8	1.11	0.144	173.2	0.09	18.28
0.9	1.12	0.159	175.3	0.09	18.08
1.0	1.14	0.171	173.9	0.09	17.89
1.1	1.14	0.213	166.3	0.08	17.71
1.5	1.22	0.238	-179	0.08	16.99
1.8	1.3	0.223	-175.2	0.09	16.45
1.9	1.31	0.229	-172	0.09	16.27
2.0	1.34	0.237	-169.3	0.09	16.07
2.1	1.36	0.243	-167.3	0.09	15.88
2.2	1.35	0.254	-165	0.09	15.69
2.3	1.4	0.255	-163.2	0.09	15.49
2.4	1.44	0.264	-159.9	0.09	15.29
2.5	1.49	0.272	-158	0.1	15.09
3.0	1.59	0.298	-142.3	0.12	14.12
3.5	1.64	0.369	-131.2	0.13	13.14
3.8	1.71	0.4	-123.8	0.16	12.56
3.9	1.74	0.41	-123	0.17	12.39
4.0	1.76	0.417	-120.2	0.18	12.19
4.5	1.96	0.469	-108	0.26	11.23
5.0	2.11	0.521	-99.4	0.35	10.34
5.5	2.38	0.555	-90.1	0.49	9.42
5.7	2.49	0.563	-87.3	0.56	9.04
5.8	2.51	0.568	-84.3	0.6	8.84
5.9	2.54	0.583	-82.7	0.64	8.7
6.0	2.61	0.579	-81.7	0.66	8.52
6.5	2.81	0.613	-72.1	0.9	7.66
7.0	3.14	0.63	-63.1	1.17	6.71
7.5	3.48	0.652	-52	1.56	5.78
8.0	3.81	0.673	-42	2.05	4.92
8.5	4.07	0.694	-32.5	2.56	4.11
9.0	4.16	0.741	-22.7	3.21	3.47
9.5	4.18	0.778	-16.7	3.89	3.2
10.0	4.62	0.771	-8.9	4.48	2.41

MGA-53543 Typical Linearity Parameters

$T_c = 25^\circ\text{C}$, $V_d = 5\text{V}$, $Z_0 = 50\ \Omega$

Freq	$\Gamma_{\text{Source}}^{[1]}$ Mag	$\Gamma_{\text{Source}}^{[1]}$ ($^\circ$)	$\Gamma_{\text{Load}}^{[1]}$ Mag	$\Gamma_{\text{Load}}^{[1]}$ ($^\circ$)	OIP3 (dBm)
500 MHz	0.31	-102	0.25	-13	40
900 MHz	0.15	-90	0.05	-165	40
1.9 GHz	0.38	156	0.05	45	39
2.4 GHz	0.49	177	0.17	141	36

Note:

1. Input and output tuners tuned for maximum OIP3 while keeping VSWR better than 2:1

MGA-53543 Applications Information

Description

The MGA-53543 is a highly linear enhancement mode PHEMT (Pseudomorphic High Electron Mobility Transistor) amplifier with a frequency range extending from 450 MHz to 6 GHz. This range makes the MGA-53543 ideal for both Cellular and PCS basestation applications. With high IP3 and low noise figure, the MGA-53543 may be utilized as a driver amplifier in a transmit chain or as a first or second stage LNA in a receive chain or any other application requiring high linearity.

The MGA-53543 operates from a +5 volt power supply and draws a nominal current of 53.8 mA. The RFIC is contained in a miniature SOT-343 (SC-70 4-lead) package to minimize printed circuit board space. This package also offers good thermal dissipation and RF characteristics.

Application Guidelines

For most applications, all that is required to operate the MGA is to apply a DC bias of +5 volts and match the RF input and output.

RF Input

The first step to achieve maximum linearity is to match the input of MGA-53543 to one of the linearity values listed on the data sheet. For example, at 1900 MHz the MGA-53543 needs to see a complex impedance of $0.38 \angle 156^\circ$ looking towards the source and an output impedance of $0.05 \angle 45^\circ$ looking towards the load. This may be accomplished by a conjugate match from the system input impedance (typically 50Ω) to Γ_s^* . Figure 10 shows the location of these input and output Gammas (Γ_s and Γ_L) required for a high linearity.

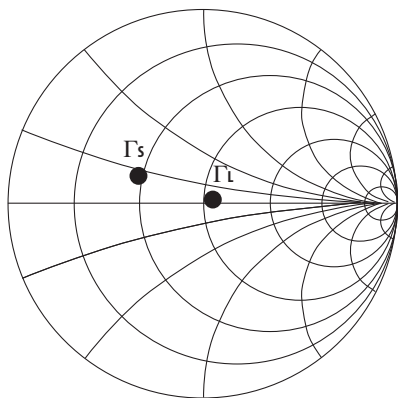

Figure 10. Matching for linearity at 1900 MHz.

RF Output

Few matching elements are required on the output of the MGA-53543 to achieve good linearity because the output Gamma (Γ_L) is close to 50Ω .

DC Bias

To bias the MGA-53543, a +5 volt supply is connected to the output pin through an inductor, RFC, which isolates the inband signal from the DC supply as shown in Figure 2. Capacitor C3 serves as an RF bypass for inband signals while C4 helps eliminate out of band low frequency signals. An optional resistor R1 may be added to de-Q any resonance created between C3 and C4. Typically values range from 2.2Ω to 10Ω . A DC blocking capacitor, C2, is used at the output of the MMIC to isolate the supply voltage from succeeding circuits.

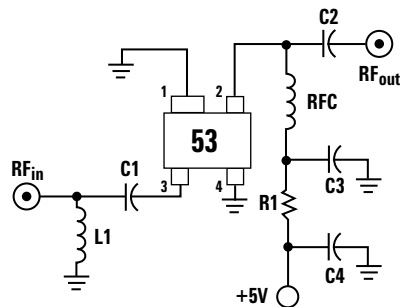

Figure 11. Schematic diagram with bias connections.

Operating at Other Voltages

Operating this RFIC at voltages less than 5V will affect NF, Gain, P1dB and IP3. Figure 12 below demonstrates the affects of changing supply voltage at 1900 MHz.

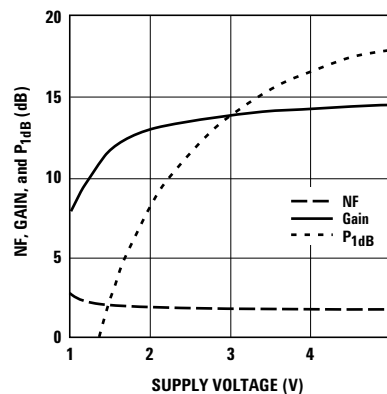

Figure 12. Gain, NF and P1dB vs. supply voltage at 1900 MHz.

The affects of supply voltage on OIP3 and current at 1900 MHz are shown in Table 1. The MGA-53543 is internally biased for optimal performance at a quiescent current of 53.8 mA.

Table 1. OIP3 vs. supply power.

Voltage (V)	OIP3 (dBm)	Id (mA)
1V	0	4
2V	17	16
3V	28	24
4V	35	41
5V	39	51

Matching

The most important criterion when designing with the MGA-53543 is choosing the input and output-matching network. The MGA-53543 is designed to give excellent IP3 performance, however to achieve this requires both the input and output matching network to present specific impedances (Γ_s and Γ_L) to the device. It is also possible to match this part for best NF or best gain. However, this will impact the IP3 performance. To achieve best noise figure, the input match will need to be modified to present gamma opt to the device. To achieve the best gain will require both the input and output to be conjugately matched (which will also result in the best return loss). Where needed, the match presented to the input and the output of the device can be modified to compromise between IP3, NF and gain performance.

The MGA-53543 has isolation large enough to allow input and output reflection coefficients to be replaced by S11 and S22.

In general matching for minimum noise figure does not necessarily guarantee good IP3 performance nor does it guarantee good gain. This is due to the fact that the impedance parameters shown below in Table 2 are not guaranteed to lie near each other on a Smith Chart. So, ideally if all input matching parameters lied near each other or at the same point, and all output parameters also lied near each other or at the same point, the amplifier would have minimum Noise Figure, maximum IP3 and maximum Gain all with a single match. Typically this is not the case and some parameter must be sacrificed to improve another. Table 2 briefly lists the input and output parameters required for each type of match while Figure 13 depicts how each is defined.

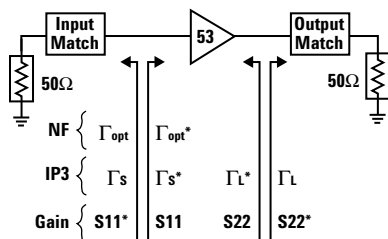

Figure 13. Definition of matching parameters.

Table 2. Required matching for NF, IP3, input & output Return Loss and Gain.

Match for	Input Tuning	Output Tuning
IP3	Γ_s	Γ_L
NF	Γ_{opt}	none
RL _{in}	S11*	none
RL _{out}	none	S22*
Gain	S11*	S22*

PCB Layout

A recommended PCB pad layout for the miniature SOT-343 (SC-70) package used by the MGA-53543 is shown in Figure 14.

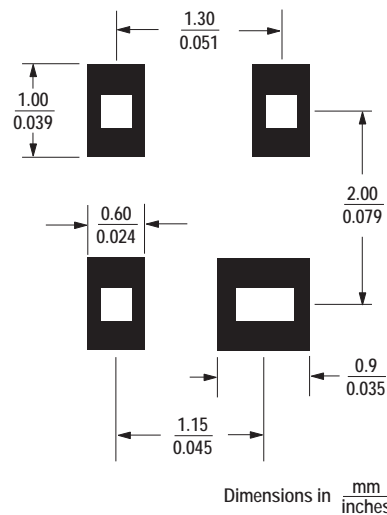

Figure 14. Recommended PCB Pad Layout for Avago's SC70 4L/SOT-343 Products.

This layout provides ample allowance for package placement by automated assembly equipment without adding parasitics that could impair the high frequency RF performance of the MGA-53543. The layout is shown with a footprint of a SOT-343 package superimposed on the PCB pads for reference.

A microstrip layout with sufficient ground vias as shown in Figure 6 is recommended for the MGA-53543 in transitioning from a package pad layout as in Figure 14.

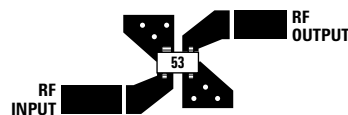

Figure 15. Microstripline Layout.

RF Grounding

Adequate grounding of Pins 1 and 4 of the RFIC are important to maintain device stability and RF performance. Each of the ground pins should be connected to the ground plane on the backside of the PCB by means of plated through holes (vias). The ground vias should be placed as close to the package terminals as practical to reduce inductance in ground path. It is good practice to use multiple vias to further minimize ground path inductance.

PCB Materials

FR-4 or G-10 type material is a good choice for most low cost wireless applications using single or multi-layer printed circuit boards. Typical single-layer board thickness is 0.020 to 0.031 inches. Circuit boards thicker than 0.031 inches are not recommended due to excessive inductance in the ground vias.

For noise figure critical or higher frequency applications, the additional cost of PTFE/glass dielectric materials may be warranted to minimize transmission line loss at the amplifier's input.

Application Example

The demonstration circuit board for the MGA-53543 is shown in Figure 16. This simple two-layer board contains microstripline on the topside and a solid metal ground plane on the backside with all RF traces having characteristic impedance of 50Ω. Multiple 0.02" vias are used to bring the ground to the topside of the board and help reduce ground inductance.

The PCB is fabricated on 0.031" thick Getek® GR200D dielectric material with dielectric constant of 4.2.

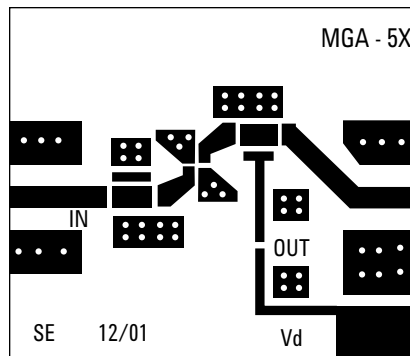

Figure 16. MGA-53543 PCB Layout.

1900 MHz HLA Design

The following describes a typical application for the MGA-53543 as used in a PCS 1900 MHz band radio receiver optimized for maximum linearity. Steps include matching the input and output as well as providing a DC bias while maintaining acceptable stability, gain and noise figure.

As described earlier, a pure linearity match entails matching only to Γ_s and Γ_L , thus sacrificing some NF and Gain. This tradeoff is explained below and quantified in Figures 8 and 9.

Using the device S-parameters at 1900 MHz, the minimum noise figure possible, whilst matching the input to Γ_s , is shown to be 1.7 dB.

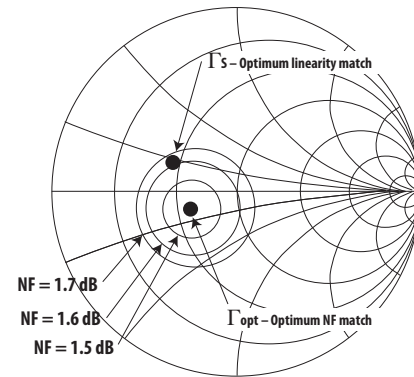

Figure 17. Noise figure performance.

Because gain depends both on the input and output match, the maximum gain is taken from two sets of circles. One is centered around S11 and the other is centered on S22. Thus the maximum attainable gain is the lesser of two circles which completely enclose Γ_s or Γ_L . For example, in Figure 18 the 16.1 dB input gain circle completely encloses Γ_s , but the smallest circle that encloses Γ_L is 15.9 dB. Thus the maximum gain is the weakest link or 15.9 dB.

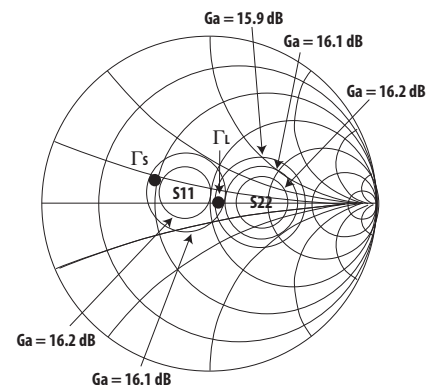

Figure 18. Input and output gain circles.

To accomplish the above performance, a high pass configuration consisting of a 3.3 nH inductor and a 2.2 pF capacitor is used for the input match. Unlike a low pass configuration, a high pass configuration provides not only the impedance transfer required, but also provides excellent stability for the demo board by diminishing low frequency gain.

No matching is required for the output, but a good rule of thumb to use when biasing is to limit series reactance to less than 5Ω and keep shunt reactance above 500Ω. Therefore choosing an RFC of 47 nH, which has a reactance of 561Ω at 1.9 GHz, helps isolate the DC supply from inband signals. If any high frequency signal is created or enters the DC supply, a 150 pF capacitor is ready to short it to ground. An 8.2 pF capacitor serves primarily as a DC block, but also helps the output match.

The completed 1900 MHz amplifier schematic is shown in Figure 19.

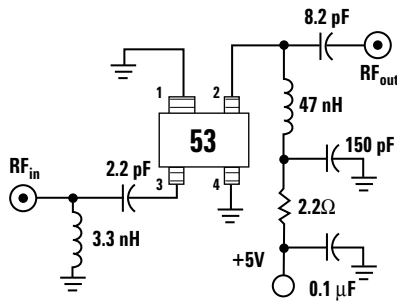

Figure 19. Schematic for a 1900 MHz stable circuit.

Included with the schematic is a complete RF layout (Figure 24) which includes placement of all components and SMA connectors. A list of part numbers and manufacturer used is given below in Table 3.

Table 3. Component parts list for the MGA-53543 HLA at 1900 MHz.

3.3 nH	TOKO LL1608-FS3N3S
47 nH	TOKO LL1005-FH47N
2.2Ω	RHOM MCR01J2R2
2.2 pF	Phycomp 0402CG229C9B200
8.2 pF	Phycomp 0402CG829D9B200
150 pF	Phycomp 0402CG151J9B200
0.1 μF	Phycomp 06032F104M8B20

Performance of MGA-53543 at 1900 MHz

With a device voltage of +5V, demonstration board MGA-5X delivers a measured noise figure of 1.78 dB and an average gain of 14.5 dB as shown in Figure 20. Gain here is slightly lower than data sheet due to the losses acquired in creating a stable broadband match. Input and output VSWR are both better than 2:1 at 1900 MHz, with input return loss being 10 dB and output return loss at 13 dB.

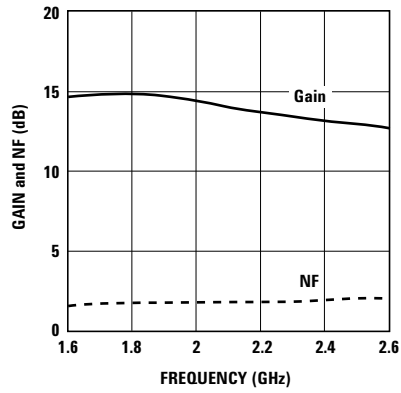

Figure 20. Gain and Noise Figure vs Frequency.

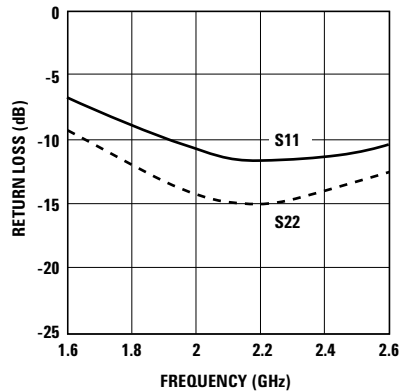

Figure 21. Input and Output return loss vs Frequency.

More significant is the linearity delivered by MGA-53543 at 1900 MHz. Figure 22 plots OIP3 over a frequency range from 1850 MHz to 1950 MHz.

This device produces IIP3 of 24 dBm, OIP3 of 38 dBm and P1dB of 17.8 dBm at 1900 MHz.

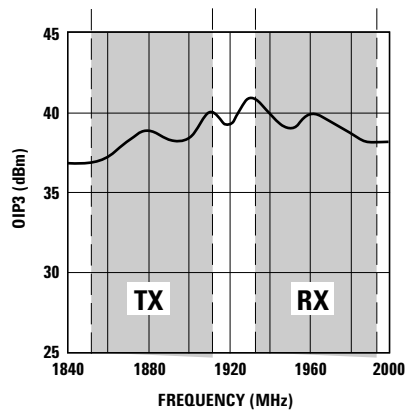

Figure 22. OIP3 vs. Frequency.

Due to component parasitics and part variations, actual performance may not be identical to this example.

900 MHz HLA Design

Optimizing the MGA-53543 for maximum linearity at the Cellular band follows very similar to that of 1900 MHz, except that the input and output tuning conditions will change according to the linearity table on the data sheet. Figure 14 below shows the schematic diagram for a complete 900 MHz circuit using Γ_s of $0.15 \angle -90^\circ$ and Γ_L of $0.05 \angle -165^\circ$. Table 4 shows the component parts list used.

An optional 2.2Ω resistor at the input helps resistively load the amplifier and improve stability but slightly degrade noise figure.

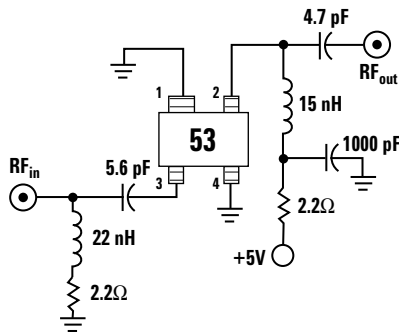

Figure 23. Schematic diagram for 900 MHz HLA.

Table 4. Component parts list for the MGA-53543 HLA at 900 MHz.

22 nH	TOKO LL1608-FS22N
15 nH	TOKO LL1005-FS15N
2.2Ω	RHOM MCR01J2R2
4.7 pF	Phycomp 0402CG479C9B200
5.6 pF	Phycomp 0402CG569D9B200
1000 pF	Phycomp 04022R102K9B200

Performance of MGA-53543 at 900 MHz

At 900 MHz MGA-53543 delivers OIP3 of 40 dBm along with a noise figure of 1.43 dB. Gain is measured to be 17.1 dB and input return loss is 13.7 dB and output return loss is 13.3 dB as shown in Figures 16 and 17. P1dB is 18.8 dBm.

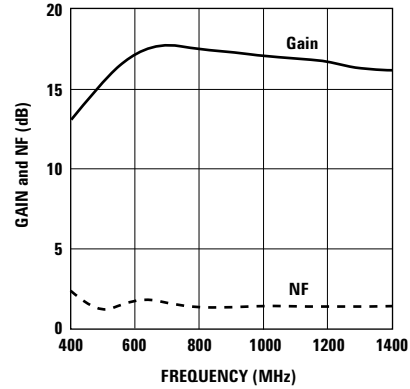

Figure 25. Gain and Noise Figure vs Frequency.

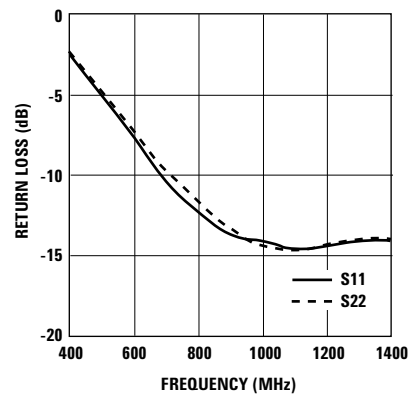

Figure 26. Input and Output return loss vs Frequency.

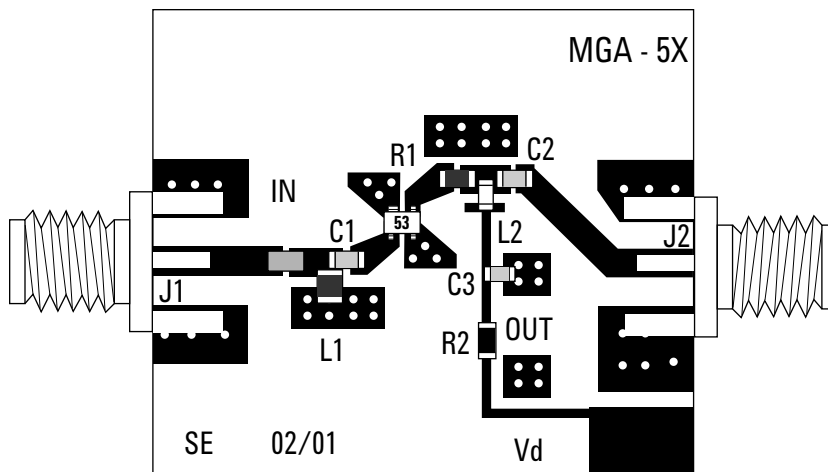

Figure 24. RF Layout for 1900 MHz HLA .

900 MHz LNA Design

To demonstrate the versatility of the MGA-53543, the following example describes a cellular band Low Noise Amplifier (LNA) design. The methodology for a 900 MHz LNA design differs from the previous examples in that only the input match affects noise figure. Thus, optimizing for minimum noise figure entails matching only the input to Γ_{opt} instead of Γ_s , and the output can either be matched to S_{22} for better gain or Γ_L for better linearity. Figure 27 shows the complete schematic for a 900 MHz low noise amplifier design and Table 5 describes the required components.

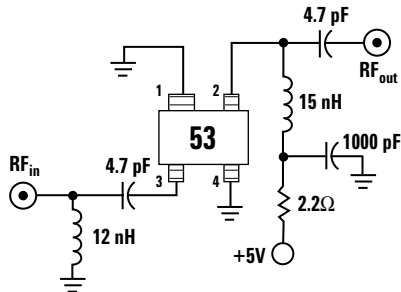

Figure 27. Schematic for 900 MHz LNA design.

Table 5. Component Parts List for the MGA-53543 HLA at 900 MHz.

12 nH	TOKO LL1608-FS12NJ
15 nH	TOKO LL1005-FS15N
4.7 pF	Phycomp 0402CG479C9B200
2.2Ω	RHOM MCR01J2R2
1000 pF	Phycomp 04022R102K9B200

Performance of MGA-53543 at 900 MHz

Biased with a +5 Volt supply MGA-53543 delivers a Noise Figure of 1.33 dB at 900 MHz. This number is higher than NF_{min} only because of loss from lumped element components with parasitic losses. A microstrip or distributed element match may improve noise figure by .2 dB. Gain is measured to be 17.4 dB as shown in Figure 28. Input and output VSWR are both better than 2:1, with input return loss of 25 dB and output return loss at 17.5 dB shown in Figure 29.

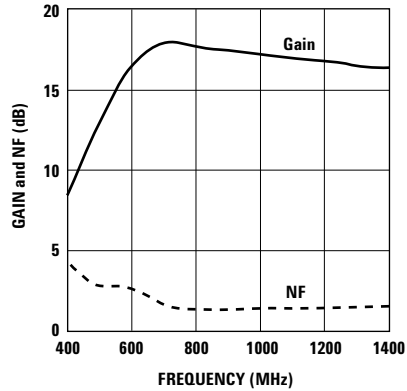

Figure 28. Gain, Noise Figure and Output Power at 900 MHz.

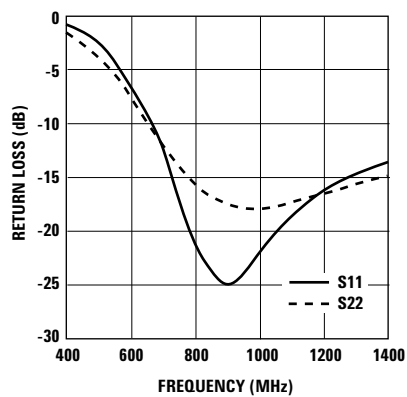

Figure 29. Input and Output return loss at 900 MHz.

Input IIP3 is measured to be 18.6 dBm and P1dB is 19.0 dB at 900 MHz.

1900 MHz LNA Design

The final example presented in this application note is a PCS band low noise amplifier circuit. As in the 900 MHz LNA example, the input is matched to Γ_{opt} which at 1900 MHz is given as $.229 \angle -172^\circ$ and the output is matched for maximum linearity i.e. Γ_L . Biasing the DC supply is done very similar to the 1900 MHz HLA. In fact, the only major difference between the PCS HLA presented earlier and this PCS LNA schematic is a 3.9nH inductor on the input. The complete schematic is shown below.

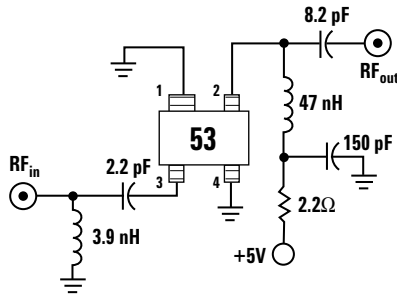

Figure 30. Schematic for 1900 MHz LNA design.

Table 6 shows the complete parts list used for the 1900 MHz low noise amplifier.

Table 6. Component parts list for the MGA-53453 LNA amplifier at 1900 MHz.

3.9 nH	TOKO LL1608-FS3N9S
47 nH	TOKO LL1005-FH47N
2.2Ω	RHOM MCR01J2R2
2.2 pF	Phycomp 0402CG229C9B200
8.2 pF	Phycomp 0402CG829D9B200
150 pF	Phycomp 0402CG151J9B200

Summary

In summary, the MGA-53543 offers very high IP3 as designed, but is versatile enough to give good NF performance wherever needed. Below is a summary of the preceding four examples.

Table 7. 1900 MHz and 900 MHz HLA and 1900 MHz and 900 MHz LNA summary.

	1900 MHz	900 MHz
HLA	NF = 1.78 dB	NF = 1.42 dB
	OIP3 = 38 dBm	OIP3 = 40 dBm
	Ga = 14.5 dB	Ga = 17.1 dB
	P1dB = 17.8 dBm	P1dB = 18.8 dBm
LNA	NF = 1.62 dB	NF = 1.33 dB
	OIP3 = 37 dBm	OIP3 = 36 dBm
	Ga = 14.8 dB	Ga = 17.4 dB
	P1dB = 18.0 dBm	P1dB = 19.0 dBm

Performance of MGA-53543 at 1900 MHz

The typical noise figure for the 1900 MHz LNA is measured to be 1.62 dB with OIP3 at a nominal 37 dBm. Figure 31 shows a measured gain of 14.8 dB and Figure 32 shows the input and output return loss to be 16.4 dB and 11.3 dB respectively. P1dB is 18 dBm.

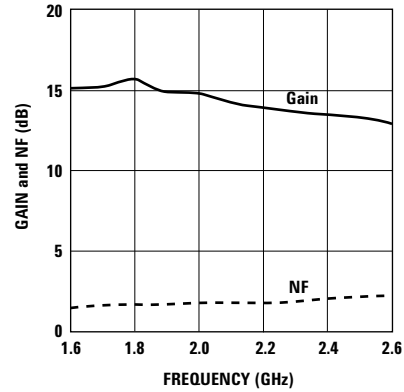

Figure 31. Gain, Noise Figure vs. Frequency for 1900 MHz LNA.

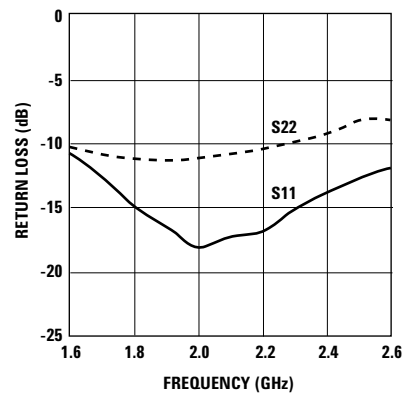

Figure 32. Input and Output Return Loss for 1900 MHz LNA.

Device Model

Refer to Avago's web site
www.avagotech.com/view/rf

Part Number Ordering Information

Part Number	No. of Devices	Container
MGA-53543-TR1G	3000	7" Reel
MGA-53543-TR2G	10000	13" Reel
MGA-53543-BLKG	100	antistatic bag

Package Dimensions

Outline 43 (SOT-343/SC70 4 lead)

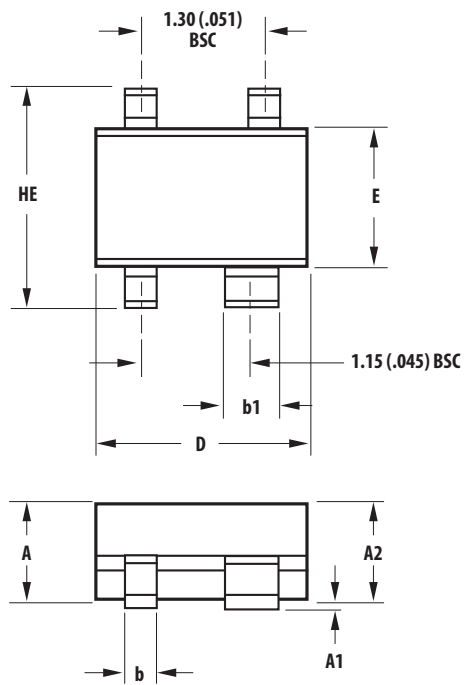

SYMBOL	DIMENSIONS (mm)	
	MIN.	MAX.
E	1.15	1.35
D	1.85	2.25
HE	1.80	2.40
A	0.80	1.10
A2	0.80	1.00
A1	0.00	0.10
b	0.15	0.40
b1	0.55	0.70
c	0.10	0.20
L	0.10	0.46

Recommended PCB Pad Layout for Avago's SC70 4L/SOT-343 Products

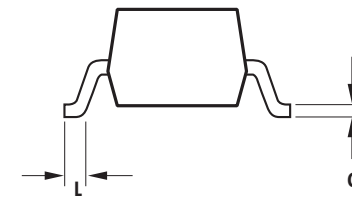
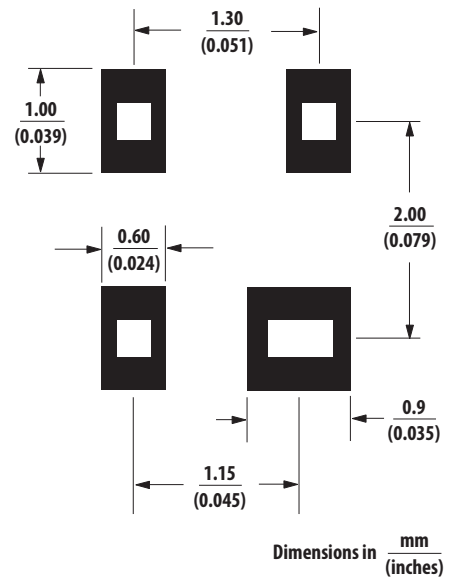

NOTES:

1. All dimensions are in mm.
2. Dimensions are inclusive of plating.
3. Dimensions are exclusive of mold flash & metal burr.
4. All specifications comply to EIAJ SC70.
5. Die is facing up for mold and facing down for trim/form, ie: reverse trim/form.
6. Package surface to be mirror finish.

Device Orientation

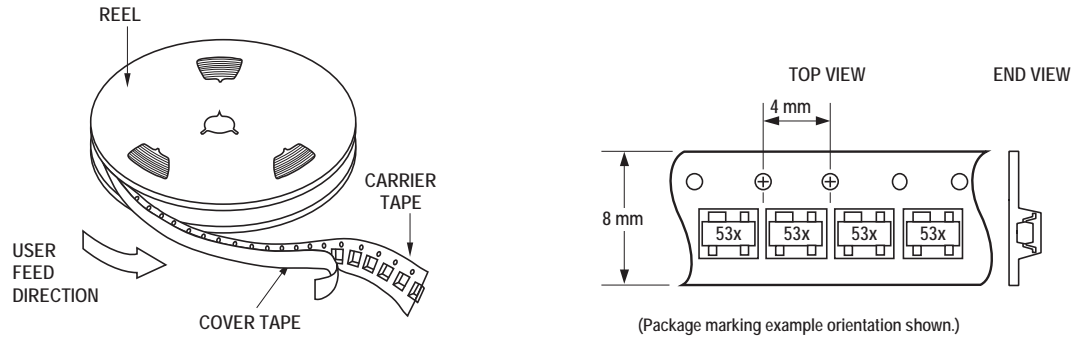

Tape Dimensions

For Outline 4T

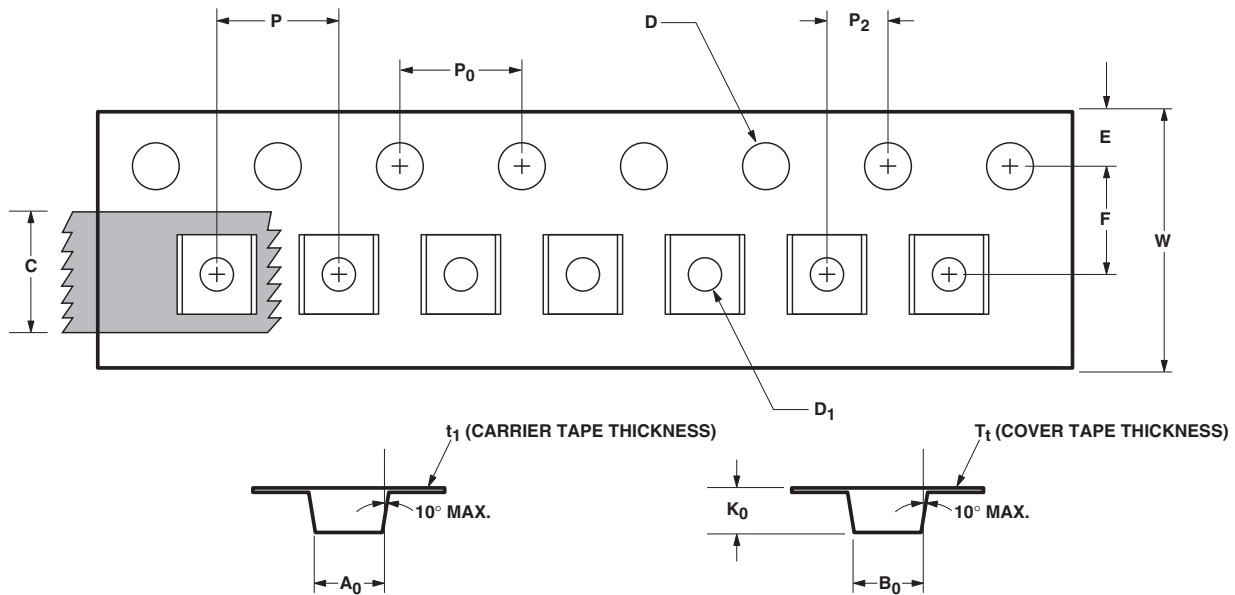

	DESCRIPTION	SYMBOL	SIZE (mm)	SIZE (INCHES)
CAVITY	LENGTH	A_0	2.40 ± 0.10	0.094 ± 0.004
	WIDTH	B_0	2.40 ± 0.10	0.094 ± 0.004
	DEPTH	K_0	1.20 ± 0.10	0.047 ± 0.004
	PITCH	P	4.00 ± 0.10	0.157 ± 0.004
	BOTTOM HOLE DIAMETER	D_1	1.00 ± 0.25	0.039 ± 0.010
PERFORATION	DIAMETER	D	1.55 ± 0.10	0.061 ± 0.002
	PITCH	P_0	4.00 ± 0.10	0.157 ± 0.004
	POSITION	E	1.75 ± 0.10	0.069 ± 0.004
CARRIER TAPE	WIDTH	W	$8.00 \pm 0.30 - 0.10$	0.315 ± 0.012
	THICKNESS	t_1	0.254 ± 0.02	0.0100 ± 0.0008
COVER TAPE	WIDTH	C	5.40 ± 0.10	0.205 ± 0.004
	TAPE THICKNESS	T_t	0.062 ± 0.001	0.0025 ± 0.0004
DISTANCE	CAVITY TO PERFORATION (WIDTH DIRECTION)	F	3.50 ± 0.05	0.138 ± 0.002
	CAVITY TO PERFORATION (LENGTH DIRECTION)	P_2	2.00 ± 0.05	0.079 ± 0.002

For product information and a complete list of distributors, please go to our web site: www.avagotech.com

Avago, Avago Technologies, and the A logo are trademarks of Avago Technologies in the United States and other countries. Data subject to change. Copyright © 2005-2012 Avago Technologies. All rights reserved. Obsoletes 5989-3741EN AV02-0455EN - June 8, 2012

Avago
TECHNOLOGIES