



200kHz, 4 μ A, Rail-to-Rail I/O Op Amps with Shutdown

MAX9910-MAX9913

General Description

The single MAX9910/MAX9911 and dual MAX9912/MAX9913 operational amplifiers (op amps) feature a maximized ratio of gain bandwidth (GBW) to supply current and are ideal for battery-powered applications such as portable instrumentation, portable medical equipment, and wireless handsets. These CMOS op amps feature an ultra-low input-bias current of 1pA, rail-to-rail inputs and outputs, low supply current of 4 μ A, and operate from a single 1.8V to 5.5V supply. For additional power conservation, the MAX9911/MAX9913 feature a low-power shutdown mode that reduces supply current to 1nA, and puts the amplifiers' outputs in a high-impedance state. These devices are unity-gain stable with a 200kHz GBW product.

The MAX9910 is available in a 5-pin SC70 package. The MAX9911 is available in tiny 6-bump WLP and a 6-pin SC70 packages. The MAX9912 is available in an 8-pin SOT23 package, and the MAX9913 is available in a 10-pin μ MAX[®] package. All devices are specified over the -40°C to +85°C extended operating temperature range.

Applications

Portable Medical Devices
 Portable Test Equipment
 Laptops
 Data-Acquisition Equipment

Typical Operating Circuit

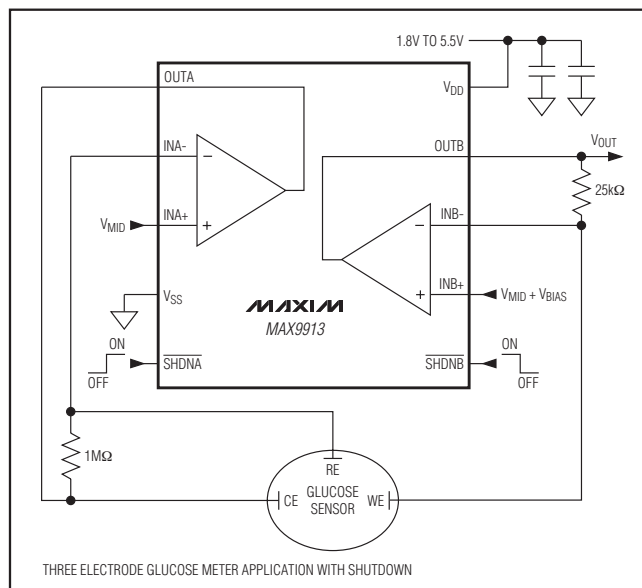

μ MAX is a registered trademark of Maxim Integrated Products, Inc.



Maxim Integrated Products 1

For pricing, delivery, and ordering information, please contact Maxim Direct at 1-888-629-4642, or visit Maxim's website at www.maxim-ic.com.

Features

- ◆ 200kHz GBW
- ◆ Ultra-Low 4 μ A Supply Current
- ◆ Single 1.8V to 5.5V Supply Voltage Range
- ◆ Ultra-Low 1pA Input Bias Current
- ◆ Rail-to-Rail Input and Output Voltage Ranges
- ◆ Low \pm 200 μ V Input Offset Voltage
- ◆ Low 0.001 μ A Shutdown Current
- ◆ High-Impedance Output During Shutdown (MAX9911/MAX9913)
- ◆ Unity-Gain Stable
- ◆ Available in Tiny WLP, SC70, SOT23, and μ MAX Packages

Ordering Information

| PART | TEMP RANGE | PIN-PACKAGE | TOP MARK |
|--------------|----------------|--------------|----------|
| MAX9910EXK+T | -40°C to +85°C | 5 SC70 | AGA |
| MAX9910EXK-T | -40°C to +85°C | 5 SC70 | AGA |
| MAX9911EXT+T | -40°C to +85°C | 6 SC70 | ACA |
| MAX9911EXT-T | -40°C to +85°C | 6 SC70 | ACA |
| MAX9911EWT+ | -40°C to +85°C | 6 WLP | BQ |
| MAX9912EKA+T | -40°C to +85°C | 8 SOT23 | AEJY |
| MAX9912EKA-T | -40°C to +85°C | 8 SOT23 | AEJY |
| MAX9913EUB | -40°C to +85°C | 10 μ MAX | — |
| MAX9913EUB+ | -40°C to +85°C | 10 μ MAX | — |

+ Denotes lead (Pb)-free/RoHS-compliant package.

Selector Guide

| PART | AMPLIFIERS PER PACKAGE | SHUTDOWN MODE |
|--------------|------------------------|---------------|
| MAX9910EXK-T | 1 | No |
| MAX9911EXT-T | 1 | Yes |
| MAX9912EKA-T | 2 | No |
| MAX9913EUB | 2 | Yes |

200kHz, 4 μ A, Rail-to-Rail I/O Op Amps with Shutdown

ABSOLUTE MAXIMUM RATINGS

Power-Supply Voltage (V_{DD} to V_{SS})-0.3V to +6.0V
 IN_+ , IN_- , OUT_- , \overline{SHDN}_- ($V_{SS} - 0.3V$) to ($V_{DD} + 0.3V$)
 Current into IN_+ , IN_- $\pm 20mA$
 Output Short-Circuit Duration to V_{DD} or V_{SS} Continuous
 Continuous Power Dissipation ($T_A = +70^\circ C$)
 5-Pin SC70 (derate 3.1mW/ $^\circ C$ above +70 $^\circ C$) 247mW
 6-Bump WLP (derate 10.5mW/ $^\circ C$ above +70 $^\circ C$) 840mW
 6-Pin SC70 (derate 3.1mW/ $^\circ C$ above +70 $^\circ C$) 245mW

8-Pin SOT23 (derate 9.1mW/ $^\circ C$ above +70 $^\circ C$) 727mW
 10-Pin μ MAX (derate 5.6mW/ $^\circ C$ above +70 $^\circ C$) 444mW
 Operating Temperature Range -40 $^\circ C$ to +85 $^\circ C$
 Junction Temperature +150 $^\circ C$
 Storage Temperature Range -65 $^\circ C$ to +150 $^\circ C$
 Lead Temperature (excluding WLP, soldering 10s) +300 $^\circ C$
 Soldering Temperature (reflow)
 Lead(Pb)-Free Packages +260 $^\circ C$
 Packages Containing Lead(Pb) +240 $^\circ C$

Stresses beyond those listed under "Absolute Maximum Ratings" may cause permanent damage to the device. These are stress ratings only, and functional operation of the device at these or any other conditions beyond those indicated in the operational sections of the specifications is not implied. Exposure to absolute maximum rating conditions for extended periods may affect device reliability.

ELECTRICAL CHARACTERISTICS

($V_{DD} = 1.8V$ to $5.5V$, $V_{SS} = 0V$, $V_{CM} = 0V$, $V_{OUT} = V_{DD} / 2$, $R_L = \infty$ connected to $V_{DD} / 2$, $\overline{SHDN}_- = V_{DD}$, $T_A = +25^\circ C$, unless otherwise noted.) (Note 1)

| PARAMETER | SYMBOL | CONDITIONS | MIN | TYP | MAX | UNITS |
|-------------------------------|-----------------------------|--|--------------------|----------|----------------|------------|
| Supply Voltage Range | V_{DD} | Guaranteed by PSRR test | 1.8 | | 5.5 | V |
| Supply Current | I_{DD} | MAX9910/MAX9911 | $V_{DD} = 1.8V$ | 4 | | μA |
| | | | $V_{DD} = 5.5V$ | 4 | 5.0 | |
| | | MAX9912/MAX9913 | $V_{DD} = 1.8V$ | 7 | | |
| | | | $V_{DD} = 5.5V$ | 7 | 9 | |
| Shutdown Supply Current | $I_{DD}(\overline{SHDN}_-)$ | $\overline{SHDN}_- = GND$, MAX9911/MAX9913 | 0.001 | 0.5 | | μA |
| Input Offset Voltage | V_{OS} | | ± 0.2 | ± 1 | | mV |
| Input-Offset-Voltage Matching | | MAX9912/MAX9913 | ± 250 | | | μV |
| Input Bias Current | I_B | (Note 2) | ± 1 | ± 10 | | pA |
| Input Offset Current | I_{OS} | (Note 2) | ± 1 | ± 10 | | pA |
| Input Resistance | R_{IN} | Common mode | | 1 | | G Ω |
| | | Differential mode, $-1mV < V_{IN} < +1mV$ | | 10 | | |
| Input Common-Mode Range | V_{CM} | Guaranteed by CMRR test | $V_{SS} - 0.1$ | | $V_{DD} + 0.1$ | V |
| Common-Mode Rejection Ratio | CMRR | $-0.1V < V_{CM} < V_{DD} + 0.1V$, $V_{DD} = 5.5V$ | 70 | 80 | | dB |
| Power-Supply Rejection Ratio | PSRR | $1.8V < V_{DD} < 5.5V$ | 65 | 95 | | dB |
| Open-Loop Gain | A_{VOL} | $25mV < V_{OUT} < V_{DD} - 25mV$, $R_L = 100k\Omega$, $V_{DD} = 5.5V$ | 95 | 120 | | dB |
| | | $100mV < V_{OUT} < V_{DD} - 100mV$, $R_L = 5k\Omega$, $V_{DD} = 5.5V$ | 95 | 110 | | |
| Output-Voltage-Swing High | V_{OH} | $V_{DD} - V_{OUT}$ | $R_L = 100k\Omega$ | 2.5 | 5 | mV |
| | | | $R_L = 5k\Omega$ | 50 | 70 | |
| | | | $R_L = 1k\Omega$ | 250 | | |
| Output-Voltage-Swing Low | V_{OL} | $V_{OUT} - V_{SS}$ | $R_L = 100k\Omega$ | 2.5 | 5 | mV |
| | | | $R_L = 5k\Omega$ | 50 | 70 | |
| | | | $R_L = 1k\Omega$ | 250 | | |
| Channel-to-Channel Isolation | CH_{ISO} | Specified at DC, MAX9912/MAX9913 | 100 | | | dB |
| Output Short-Circuit Current | $I_{OUT(SC)}$ | | ± 15 | | | mA |

200kHz, 4μA, Rail-to-Rail I/O Op Amps with Shutdown

MAX9910-MAX9913

ELECTRICAL CHARACTERISTICS (continued)

($V_{DD} = 1.8V$ to $5.5V$, $V_{SS} = 0V$, $V_{CM} = 0V$, $V_{OUT} = V_{DD} / 2$, $R_L = \infty$ connected to $V_{DD} / 2$, $\overline{SHDN}_- = V_{DD}$, $T_A = +25^\circ C$, unless otherwise noted.) (Note 1)

| PARAMETER | SYMBOL | CONDITIONS | MIN | TYP | MAX | UNITS |
|---|------------------------------|--|-------------------------------------|-------|-----|--------|
| \overline{SHDN}_- Logic Low | V_{IL} | $V_{DD} = 1.8V$ to $3.6V$, MAX9911/MAX9913 | | | 0.4 | V |
| | | $V_{DD} = 3.6V$ to $5.5V$, MAX9911/MAX9913 | | | 0.8 | |
| \overline{SHDN}_- Logic High | V_{IH} | $V_{DD} = 1.8V$ to $3.6V$, MAX9911/MAX9913 | 1.4 | | | V |
| | | $V_{DD} = 3.6V$ to $5.5V$, MAX9911/MAX9913 | 2 | | | |
| \overline{SHDN}_- Input Bias Current | I_{IL} | $\overline{SHDN}_- = V_{SS}$, MAX9911/MAX9913 (Note 2) | | | 1 | nA |
| | I_{IH} | $\overline{SHDN}_- = V_{DD}$, MAX9911/MAX9913 | | | 500 | |
| Output Leakage in Shutdown | $I_{OUT}(\overline{SHDN}_-)$ | $\overline{SHDN}_- = V_{SS}$, $V_{OUT} = 0V$ to V_{DD} , MAX9911/MAX9913 | | 1 | 500 | nA |
| Gain-Bandwidth Product | | | | 200 | | kHz |
| Slew Rate | | | | 0.1 | | V/μs |
| Capacitive-Load Stability (See the <i>Driving Capacitive Loads</i> Section) | C_{LOAD} | No sustained oscillations | $A_V = 1V/V$ | | 30 | pF |
| | | | $A_V = 10V/V$ | | 250 | |
| | | | $R_L = 5k\Omega$, $A_V = 1V/V$ | | 200 | |
| | | | $R_{ISO} = 1k\Omega$, $A_V = 1V/V$ | | 100 | |
| Input Voltage-Noise Density | | $f = 1kHz$ | | 400 | | nV/√Hz |
| Input Current-Noise Density | | $f = 1kHz$ | | 0.001 | | pA/√Hz |
| Settling Time | | To 0.1%, $V_{OUT} = 2V$ step, $A_V = -1V/V$ | | 18 | | μs |
| Delay Time to Shutdown | t_{SH} | $I_{DD} = 5\%$ of normal operation, $V_{DD} = 5.5V$, $V_{\overline{SHDN}_-} = 5.5V$ to 0 step | | 2 | | μs |
| Delay Time to Enable | t_{EN} | $V_{OUT} = 2.7V$, V_{OUT} settles to 0.1%, $V_{DD} = 5.5V$, $V_{\overline{SHDN}_-} = 0$ to 5.5V step | | 30 | | μs |
| Power-Up Time | | $V_{DD} = 0$ to 5.5V step | | 5 | | μs |

ELECTRICAL CHARACTERISTICS

($V_{DD} = 1.8V$ to $5.5V$, $V_{SS} = 0V$, $V_{CM} = 0V$, $V_{OUT} = V_{DD} / 2$, $R_L = \infty$ connected to $V_{DD} / 2$, $\overline{SHDN}_- = V_{DD}$, $T_A = -40^\circ C$ to $+85^\circ C$, unless otherwise noted.) (Note 1)

| PARAMETER | SYMBOL | CONDITIONS | MIN | TYP | MAX | UNITS |
|--|-----------------------------|---|-----|-----|-----|-------|
| Supply Voltage Range | V_{DD} | Guaranteed by PSRR test | 1.8 | | 5.5 | V |
| Supply Current | I_{DD} | MAX9910/MAX9911 | | | 5.5 | μA |
| | | MAX9912/MAX9913 | | | 11 | |
| Shutdown Supply Current | $I_{DD}(\overline{SHDN}_-)$ | $\overline{SHDN}_- = GND$, MAX9911/MAX9913 | | | 1 | μA |
| Input Offset Voltage | V_{OS} | | | | ±5 | mV |
| Input-Offset-Voltage Temperature Coefficient | TC_{VOS} | | | ±5 | | μV/°C |

200kHz, 4μA, Rail-to-Rail I/O Op Amps with Shutdown

ELECTRICAL CHARACTERISTICS (continued)

($V_{DD} = 1.8V$ to $5.5V$, $V_{SS} = 0V$, $V_{CM} = 0V$, $V_{OUT} = V_{DD} / 2$, $R_L = \infty$ connected to $V_{DD} / 2$, $\overline{SHDN}_- = V_{DD}$, $T_A = -40^\circ C$ to $+85^\circ C$, unless otherwise noted.) (Note 1)

| PARAMETER | SYMBOL | CONDITIONS | MIN | TYP | MAX | UNITS |
|--|------------------------------|--|--------------------|-----|-----------------|-------|
| Input Bias Current | I_B | | | | ±30 | pA |
| Input Offset Current | I_{OS} | | | | ±20 | pA |
| Input Common-Mode Range | V_{CM} | Guaranteed by CMRR test | $V_{SS} - 0.05$ | | $V_{DD} + 0.05$ | V |
| Common-Mode Rejection Ratio | CMRR | $-0.05V < V_{CM} < V_{DD} + 0.05V$, $V_{DD} = 5.5V$ | 60 | | | dB |
| Power-Supply Rejection Ratio | PSRR | $1.8V < V_{DD} < 5.5V$ | 59 | | | dB |
| Open-Loop Gain | A_{VOL} | $25mV < V_{OUT} < V_{DD} - 25mV$, $R_L = 100k\Omega$, $V_{DD} = 5.5V$ | 85 | | | dB |
| | | $150mV < V_{OUT} < V_{DD} - 150mV$, $R_L = 5k\Omega$, $V_{DD} = 5.5V$ | 80 | | | |
| Output-Voltage-Swing High | V_{OH} | $V_{DD} - V_{OUT}$ | $R_L = 100k\Omega$ | | 5 | mV |
| | | | $R_L = 5k\Omega$ | | 90 | |
| Output-Voltage-Swing Low | V_{OL} | $V_{OUT} - V_{SS}$ | $R_L = 100k\Omega$ | | 5 | mV |
| | | | $R_L = 5k\Omega$ | | 90 | |
| \overline{SHDN}_- Logic Low | V_{IL} | $V_{DD} = 1.8V$ to $3.6V$ | | | 0.4 | V |
| | | $V_{DD} = 3.6V$ to $5.5V$ | | | 0.8 | |
| \overline{SHDN}_- Logic High | V_{IH} | $V_{DD} = 1.8V$ to $3.6V$, MAX9911/MAX9913 | 1.4 | | | V |
| | | $V_{DD} = 3.6V$ to $5.5V$, MAX9911/MAX9913 | 2 | | | |
| \overline{SHDN}_- Input-Bias Current | I_{IL} | $\overline{SHDN}_- = V_{SS}$, MAX9911/MAX9913 | | | 5 | nA |
| | I_{IH} | $\overline{SHDN}_- = V_{DD}$, MAX9911/MAX9913 | | | 1000 | nA |
| Output Leakage in Shutdown | $I_{OUT(\overline{SHDN}_-)}$ | $\overline{SHDN}_- = V_{SS}$, $V_{OUT} = 0V$ to V_{DD} , MAX9911/MAX9913 | | | 1000 | nA |

Note 1: Specifications are 100% tested at $T_A = +25^\circ C$ (exceptions noted). All temperature limits are guaranteed by design.

Note 2: Guaranteed by design, not production tested.

200kHz, 4 μ A, Rail-to-Rail I/O Op Amps with Shutdown

Typical Operating Characteristics

($V_{DD} = 3V$, $V_{SS} = V_{CM} = 0V$, R_L to $V_{DD} / 2$, $T_A = +25^\circ C$, unless otherwise noted.)

MAX9910-MAX9913

SUPPLY CURRENT vs. SUPPLY VOLTAGE

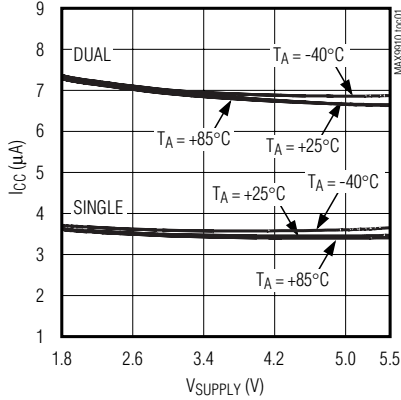

SHUTDOWN SUPPLY CURRENT vs. TEMPERATURE

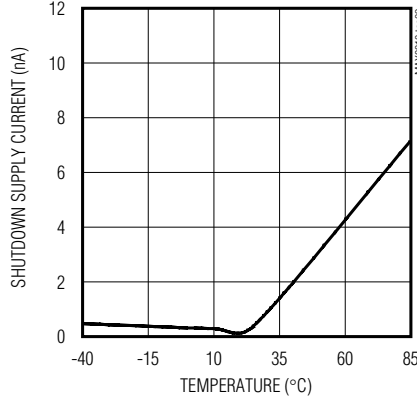

INPUT OFFSET VOLTAGE vs. INPUT COMMON-MODE VOLTAGE

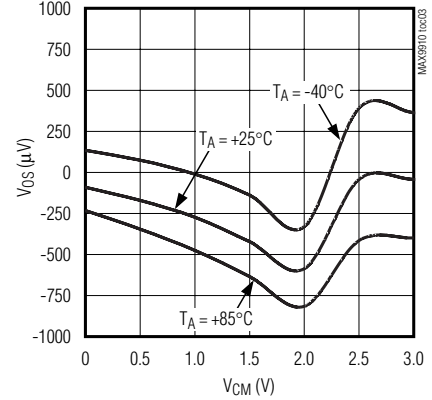

INPUT OFFSET VOLTAGE vs. TEMPERATURE

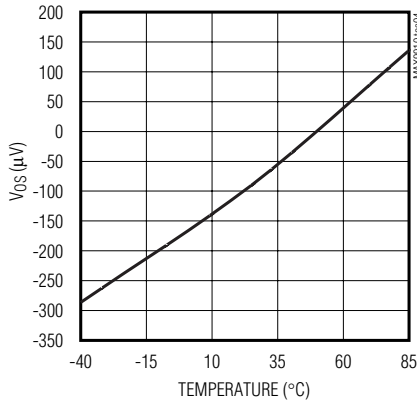

INPUT BIAS CURRENT vs. TEMPERATURE

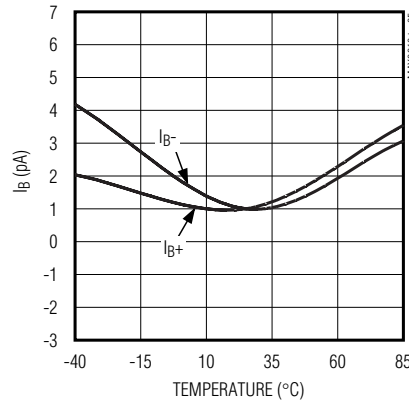

INPUT BIAS CURRENT vs. INPUT COMMON-MODE VOLTAGE

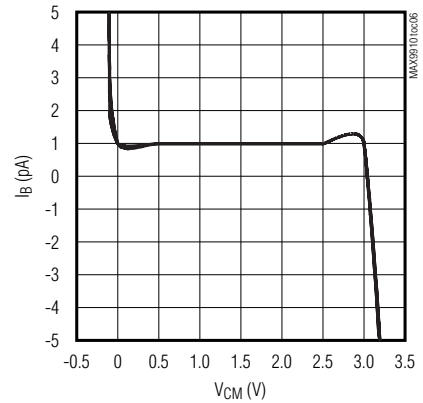

POWER-SUPPLY REJECTION RATIO vs. FREQUENCY

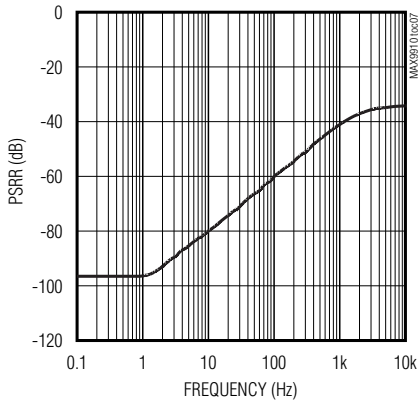

COMMON-MODE REJECTION RATIO vs. TEMPERATURE

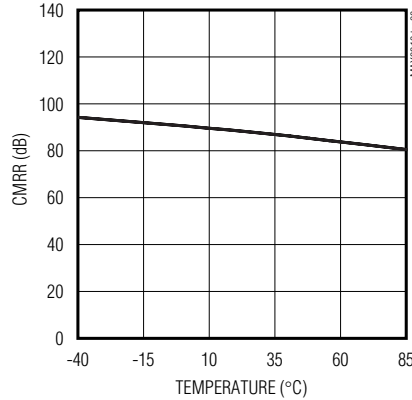

COMMON-MODE REJECTION RATIO vs. FREQUENCY

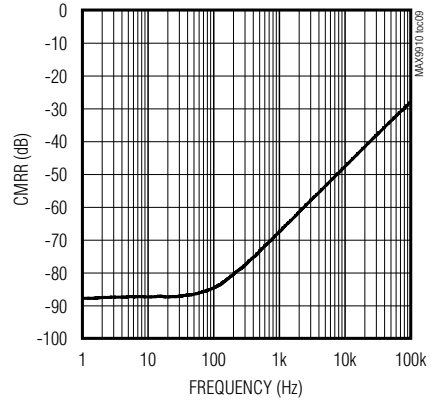

200kHz, 4μA, Rail-to-Rail I/O Op Amps with Shutdown

Typical Operating Characteristics (continued)

($V_{DD} = 3V$, $V_{SS} = V_{CM} = 0V$, R_L to $V_{DD} / 2$, $T_A = +25^\circ C$, unless otherwise noted.)

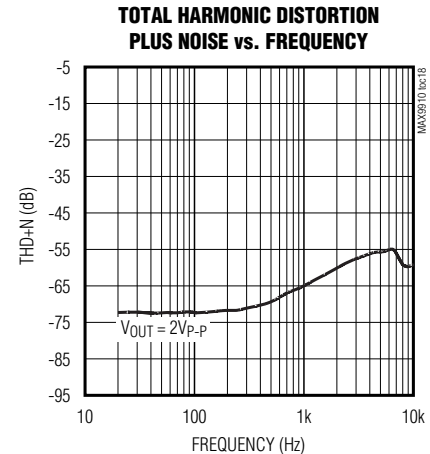
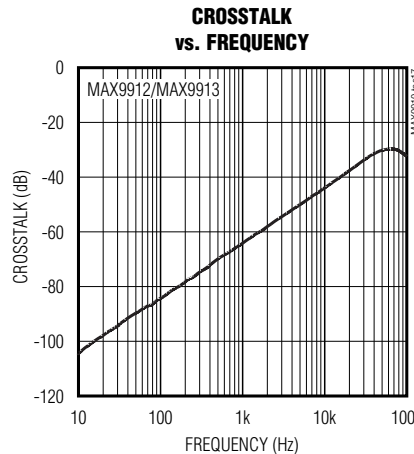
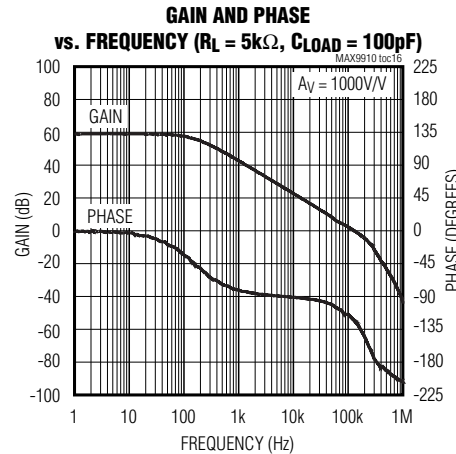
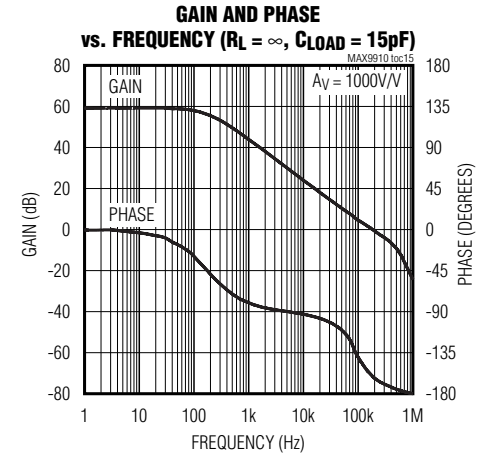
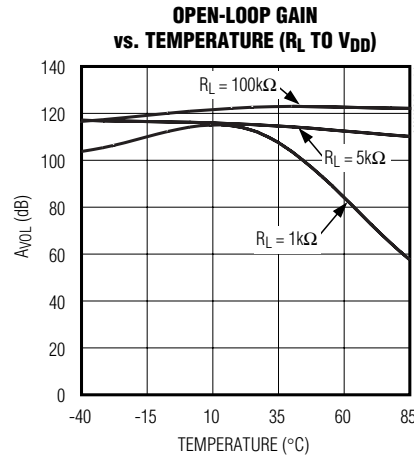
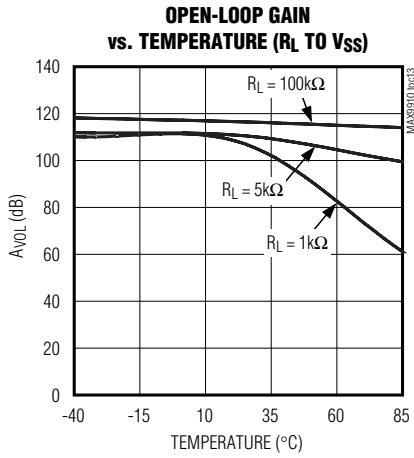
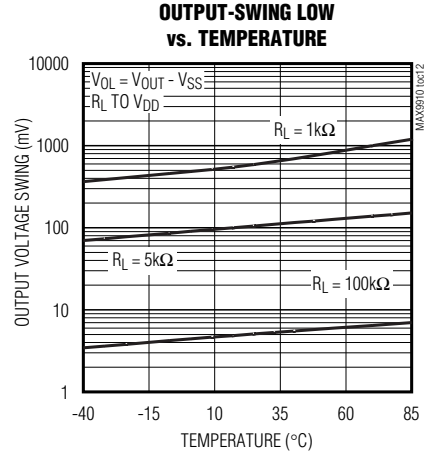
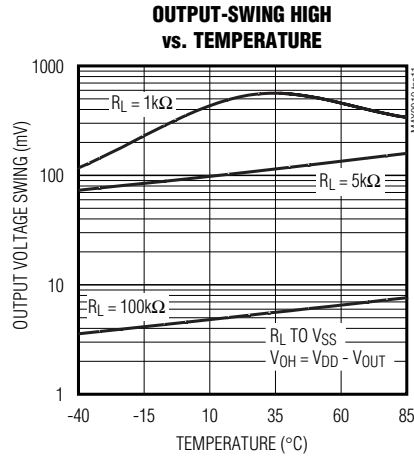
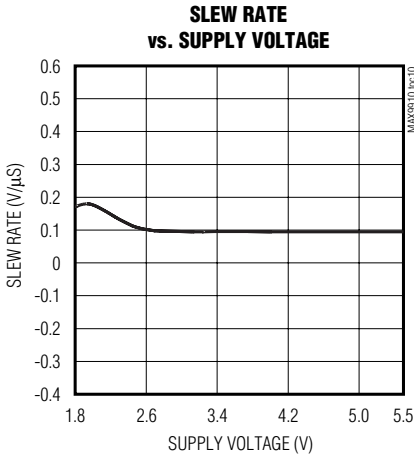

200kHz, 4μA, Rail-to-Rail I/O Op Amps with Shutdown

Typical Operating Characteristics (continued)

($V_{DD} = 3V$, $V_{SS} = V_{CM} = 0V$, R_L to $V_{DD} / 2$, $T_A = +25^\circ C$, unless otherwise noted.)

MAX9910-MAX9913

VOLTAGE-NOISE DENSITY vs. FREQUENCY

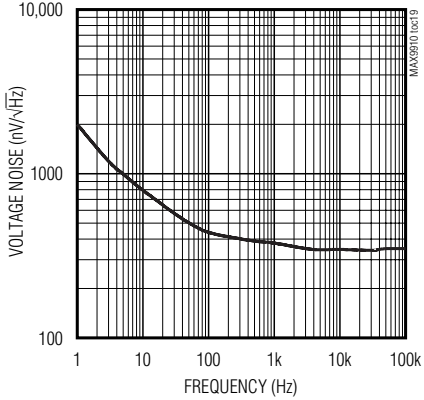

RESISTOR ISOLATION vs. CAPACITIVE LOAD

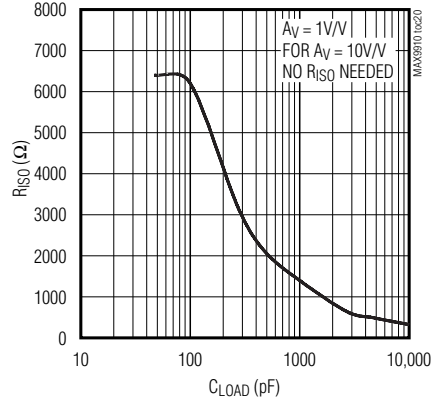

POWER-UP SETTLING TIME

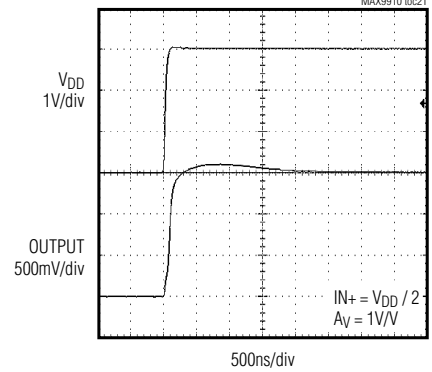

SHUTDOWN RESPONSE

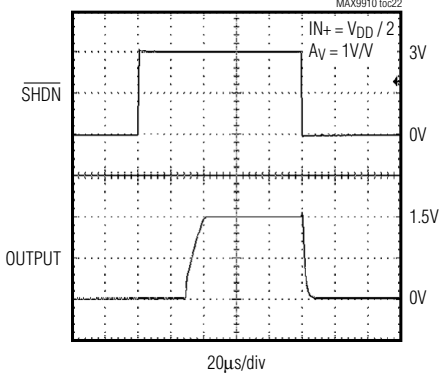

SMALL-SIGNAL PULSE RESPONSE (CLOAD = 15pF)

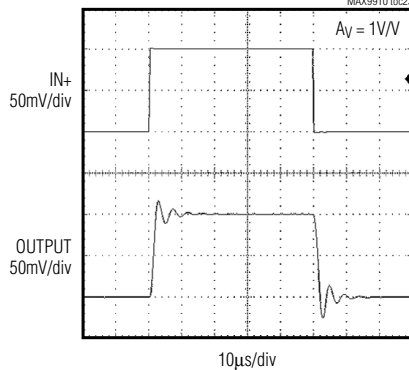

SMALL-SIGNAL PULSE RESPONSE (CLOAD = 100pF)

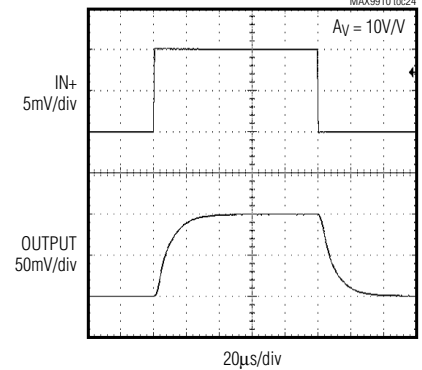

LARGE-SIGNAL PULSE RESPONSE (CLOAD = 15pF)

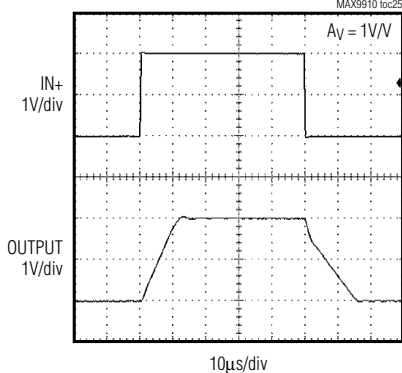

LARGE-SIGNAL PULSE RESPONSE (CLOAD = 100pF)

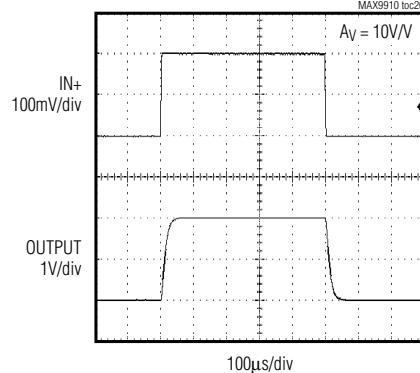

200kHz, 4μA, Rail-to-Rail I/O Op Amps with Shutdown

Typical Operating Characteristics (continued)

($V_{DD} = 3V$, $V_{SS} = V_{CM} = 0V$, R_L to $V_{DD} / 2$, $T_A = +25^\circ C$, unless otherwise noted.)

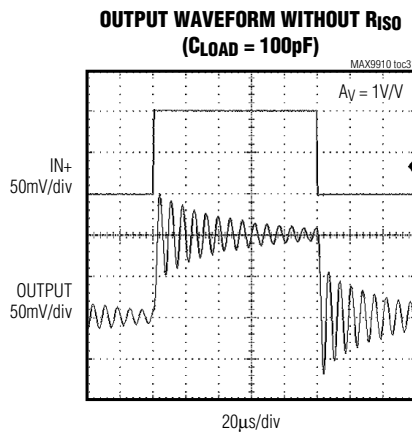
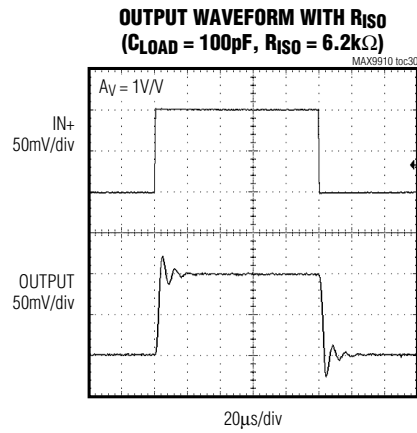
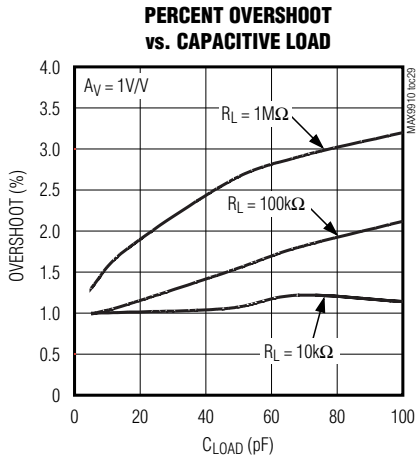
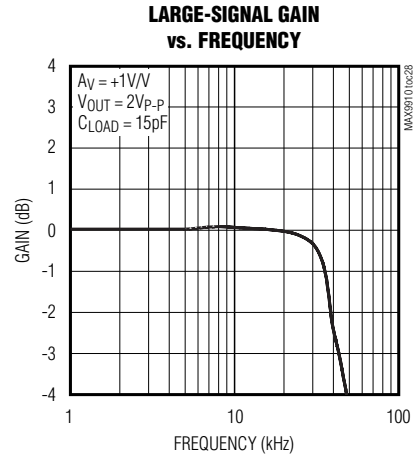
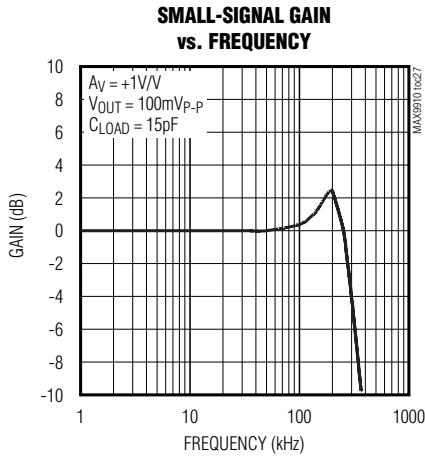

200kHz, 4 μ A, Rail-to-Rail I/O Op Amps with Shutdown

Pin Description

| PIN | | | | | NAME | FUNCTION |
|---------------|---------|----------------|---------|---------|---------------------------|--|
| MAX9911 (WLP) | MAX9910 | MAX9911 (SC70) | MAX9912 | MAX9913 | | |
| A1 | 1 | 1 | — | — | IN+ | Noninverting Amplifier Input |
| A2 | 2 | 2 | 4 | 4 | V _{SS} | Negative Supply Voltage |
| B1 | 3 | 3 | — | — | IN- | Inverting Amplifier Input |
| C1 | 4 | 4 | — | — | OUT | Amplifier Output |
| B2 | 5 | 6 | 8 | 10 | V _{DD} | Positive Supply Voltage |
| C2 | — | 5 | — | — | $\overline{\text{SHDN}}$ | Shutdown |
| — | — | — | 1 | 1 | OUTA | Amplifier Output Channel A |
| — | — | — | 2 | 2 | INA- | Inverting Amplifier Input Channel A |
| — | — | — | 3 | 3 | INA+ | Noninverting Amplifier Input Channel A |
| — | — | — | — | 5 | $\overline{\text{SHDNA}}$ | Shutdown Channel A |
| — | — | — | — | 6 | $\overline{\text{SHDNB}}$ | Shutdown Channel B |
| — | — | — | 5 | 7 | INB+ | Noninverting Amplifier Input Channel B |
| — | — | — | 6 | 8 | INB- | Inverting Amplifier Input Channel B |
| — | — | — | 7 | 9 | OUTB | Amplifier Output Channel B |

MAX9910–MAX9913

Detailed Description

Featuring a maximized ratio of GBW to supply current, low operating supply voltage, low input bias current, and rail-to-rail inputs and outputs, the MAX9910–MAX9913 are an excellent choice for precision or general-purpose, low-current, low-voltage, battery-powered applications. These CMOS devices consume an ultra-low 4 μ A (typ) supply current and a 200 μ V (typ) offset voltage. For additional power conservation, the MAX9911/MAX9913 feature a low-power shutdown mode that reduces supply current to 1nA (typ), and puts the amplifiers' output in a high-impedance state. These devices are unity-gain stable with a 200kHz GBW product, driving capacitive loads up to 30pF. The capacitive load can be increased to 250pF when the amplifier is configured for a 10V/V gain.

Rail-to-Rail Inputs and Outputs

All of the MAX9910–MAX9913 amplifiers have a parallel-connected n- and p-channel differential input stage that allows an input common-mode voltage range that extends 100mV beyond the positive and negative supply rails, with excellent common-mode rejection.

The MAX9910–MAX9913 are capable of driving the output to within 5mV of both supply rails with a 100k Ω

load. These devices can drive a 5k Ω load with swings to within 60mV of the rails. Figure 1 shows the output voltage swing of the MAX9910–MAX9913 configured as a unity-gain buffer powered from a single 3V supply.

Low Input Bias Current

The MAX9910–MAX9913 feature ultra-low 1pA (typ) input bias current. The variation in the input bias current is minimal with changes in the input voltage due to very high input impedance (in the order of 1G Ω).

Applications Information

Driving Capacitive Loads

The MAX9910–MAX9913 amplifiers are unity-gain stable for loads up to 30pF. However, the capacitive load can be increased to 250pF when the amplifier is configured for a minimum gain of 10V/V. Applications that require greater capacitive-drive capability should use an isolation resistor between the output and the capacitive load (Figure 2). Also, in unity-gain applications with relatively small R_L (approximately 5k Ω), the capacitive load can be increased up to 200pF.

Power-Supply Considerations

The MAX9910–MAX9913 are optimized for single 1.8V to 5.5V supply operation. A high amplifier power-supply

200kHz, 4μA, Rail-to-Rail I/O Op Amps with Shutdown

rejection ratio of 95dB (typ) allows the devices to be powered directly from a battery, simplifying design and extending battery life.

Power-Up Settling Time

The MAX9910-MAX9913 typically require 5μs after power-up. Supply settling time depends on the supply voltage, the value of the bypass capacitor, the output impedance of the incoming supply, and any lead resistance or inductance between components. Op-amp settling time depends primarily on the output voltage and is slew-rate limited. Figure 3 shows the MAX991_ in a noninverting voltage follower configuration with the input held at midsupply. The output settles in approximately 18μs for V_{DD} = 3V (see the *Typical Operating Characteristics* for power-up settling time).

Shutdown Mode

The MAX9911/MAX9913 feature active-low shutdown inputs. The MAX9911/MAX9913 enter shutdown in 2μs (typ) and exit in 30μs (typ). The amplifiers' outputs are in a high-impedance state in shutdown mode. Drive $\overline{\text{SHDN}}$ low to enter shutdown. Drive $\overline{\text{SHDN}}$ high to enable the amplifier. The MAX9913 dual-amplifier features separate shutdown inputs. Shut down both amplifiers for the lowest quiescent current.

Power-Supply Bypassing and Layout

To minimize noise, bypass V_{DD} with a 0.1μF capacitor to ground, as close to the pin as possible.

Good layout techniques optimize performance by decreasing the amount of stray capacitance and inductance to the op amps' inputs and outputs. Minimize stray capacitance and inductance by placing external components close to the IC.

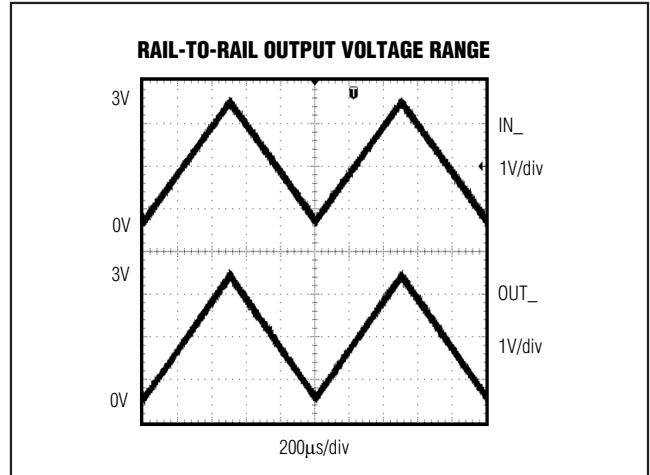

Figure 1. Rail-to-Rail Output Voltage Range

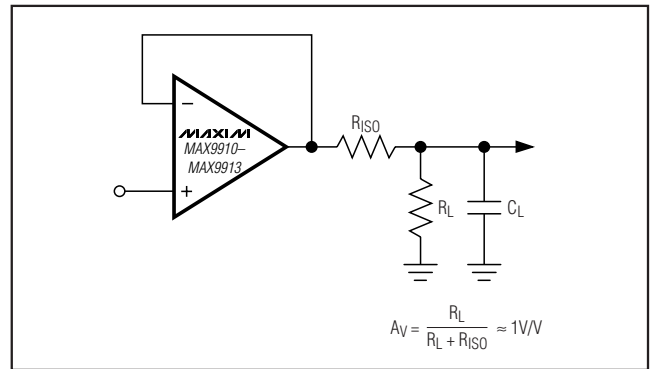

Figure 2. Using a Resistor to Isolate a Capacitive Load from the Op Amp

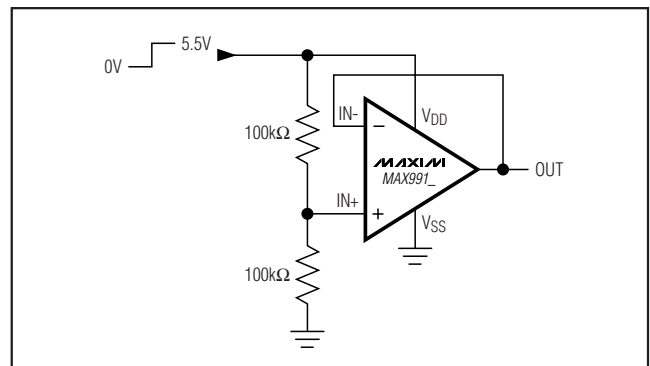
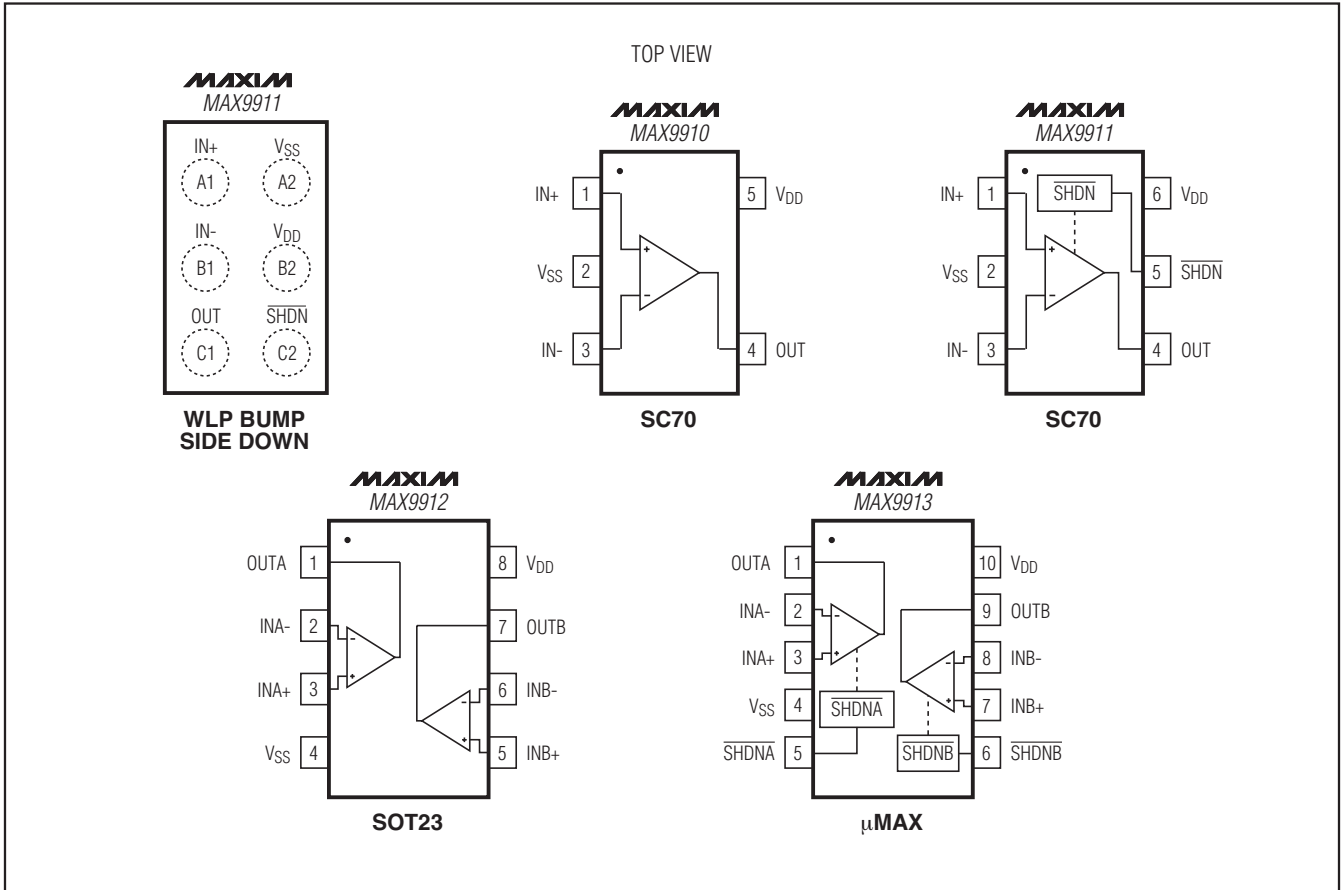

Figure 3. Power-Up Test Configuration

200kHz, 4 μ A, Rail-to-Rail I/O Op Amps with Shutdown

Pin Configurations

MAX9910-MAX9913



Chip Information

PROCESS: BiCMOS

200kHz, 4μA, Rail-to-Rail I/O Op Amps with Shutdown

Package Information

For the latest package outline information and land patterns, go to www.maxim-ic.com/packages. Note that a "+", "#", or "-" in the package code indicates RoHS status only. Package drawings may show a different suffix character, but the drawing pertains to the package regardless of RoHS status.

| PACKAGE TYPE | PACKAGE CODE | OUTLINE NO. | LAND PATTERN NO. |
|--------------|--------------|-------------------------|-------------------------|
| 5 SC70 | X5+1 | 21-0076 | 90-0188 |
| 6 SC70 | X6SN+1 | 21-0077 | 90-0189 |
| 6 WLP | W61B1+1 | 21-0217 | — |
| 8 SOT23 | K8+5 | 21-0078 | 90-0176 |
| 10 μMAX | U10+2 | 21-0061 | 90-0330 |

| SYMBOL | MIN | NOM | MAX |
|-----------|------------|------|------|
| A | 0.80 | 0.95 | 1.10 |
| A1 | 0.00 | 0.07 | 0.10 |
| A2 | 0.80 | 0.90 | 1.00 |
| b | 0.15 | 0.22 | 0.30 |
| c | 0.10 | 0.14 | 0.18 |
| D | 1.80 | 2.00 | 2.20 |
| e | 0.65 BSC. | | |
| E | 1.15 | 1.25 | 1.35 |
| HE | 1.80 | 2.20 | 2.40 |
| L | 0.26 | 0.34 | 0.46 |
| L1 | 0.425 TYP. | | |
| Q1 | 0.10 | 0.25 | 0.40 |
| PKG. CODE | X5-1 | | |

NOTES:

- ALL DIMENSIONS ARE IN MILLIMETERS.
- DIMENSIONS ARE INCLUSIVE OF PLATING.
- DIMENSIONS ARE EXCLUSIVE OF MOLD FLASH & METAL BURR.
- COMPLY TO JEITA SC-88A EXCEPT FOR DIMENSION "L". ALL DIMENSIONS COMPLY TO JEDEC MO-203.
- COPLANARITY 4 MILS. MAX.
- FOOT LENGTH MEASURED AT INTERCEPT POINT BETWEEN DATUM "A" AND LEAD SURFACE.
- MARKING IS FOR PACKAGE ORIENTATION REFERENCE ONLY.
- LEAD CENTERLINES TO BE AT TRUE POSITION AS DEFINED BY BASIC DIMENSION "e", ±0.05.

-DRAWING NOT TO SCALE-

| | |
|---------------------------------|------------------------------|
| | |
| TITLE: PACKAGE OUTLINE, 5L SC70 | |
| APPROVAL: | JUDGMENT CONTROL NO. 21-0076 |
| REV. E | 1/1 |

SC70, 5LEPS

200kHz, 4μA, Rail-to-Rail I/O Op Amps with Shutdown

Package Information (continued)

For the latest package outline information and land patterns, go to www.maxim-ic.com/packages. Note that a "+", "#", or "-" in the package code indicates RoHS status only. Package drawings may show a different suffix character, but the drawing pertains to the package regardless of RoHS status.

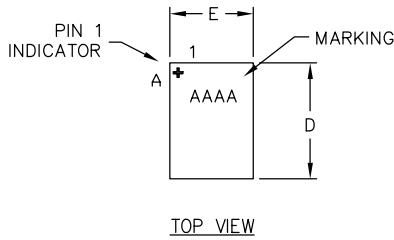

TOP VIEW

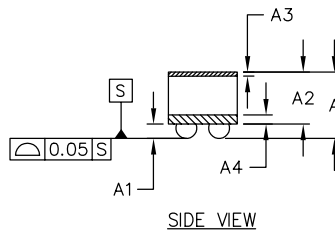

SIDE VIEW

| COMMON DIMENSIONS | |
|-------------------|-------------|
| A | 0.64±0.05 |
| A1 | 0.19±0.03 |
| A2 | 0.45 REF |
| A3 | 0.025 BASIC |
| A4 | 0.07 BASIC |
| b | ∅0.27±0.03 |
| D1 | 0.80 BASIC |
| E1 | 0.40 BASIC |
| e | 0.40 BASIC |
| SD | 0.00 BASIC |
| SE | 0.20 BASIC |

| PKG. CODE | E | | D | | DEPOPULATED BUMPS |
|-----------|------|------|------|------|-------------------|
| | MIN | MAX | MIN | MAX | |
| W61B1+1 | 0.76 | 0.97 | 1.17 | 1.37 | NONE |
| W61D1+1 | 0.95 | 1.02 | 1.36 | 1.42 | NONE |

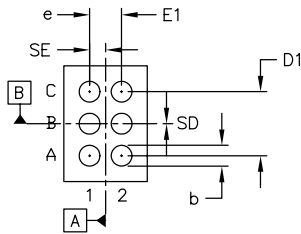

BOTTOM VIEW

NOTES:

1. Terminal pitch is defined by terminal center to center value.
2. Outer dimension is defined by center lines between scribe lines.
3. All dimensions in millimeters.
4. Marking shown is for package orientation reference only.
5. Tolerance is ± 0.02mm unless specified otherwise.
6. All dimensions apply to PbFree (+) package codes only.

-DRAWING NOT TO SCALE-

| | | | |
|--|---------------------------------|-----------|-----|
| MAXIM | | | |
| TITLE: PACKAGE OUTLINE 6 BUMPS, WLP PKG. 0.4mm PITCH | | | |
| APPROVAL | DOCUMENT CONTROL NO. 21-0217 | REV. B | 1/1 |

200kHz, 4 μ A, Rail-to-Rail I/O Op Amps with Shutdown

Package Information (continued)

For the latest package outline information and land patterns, go to www.maxim-ic.com/packages. Note that a "+", "#", or "-" in the package code indicates RoHS status only. Package drawings may show a different suffix character, but the drawing pertains to the package regardless of RoHS status.

MAX9910-MAX9913

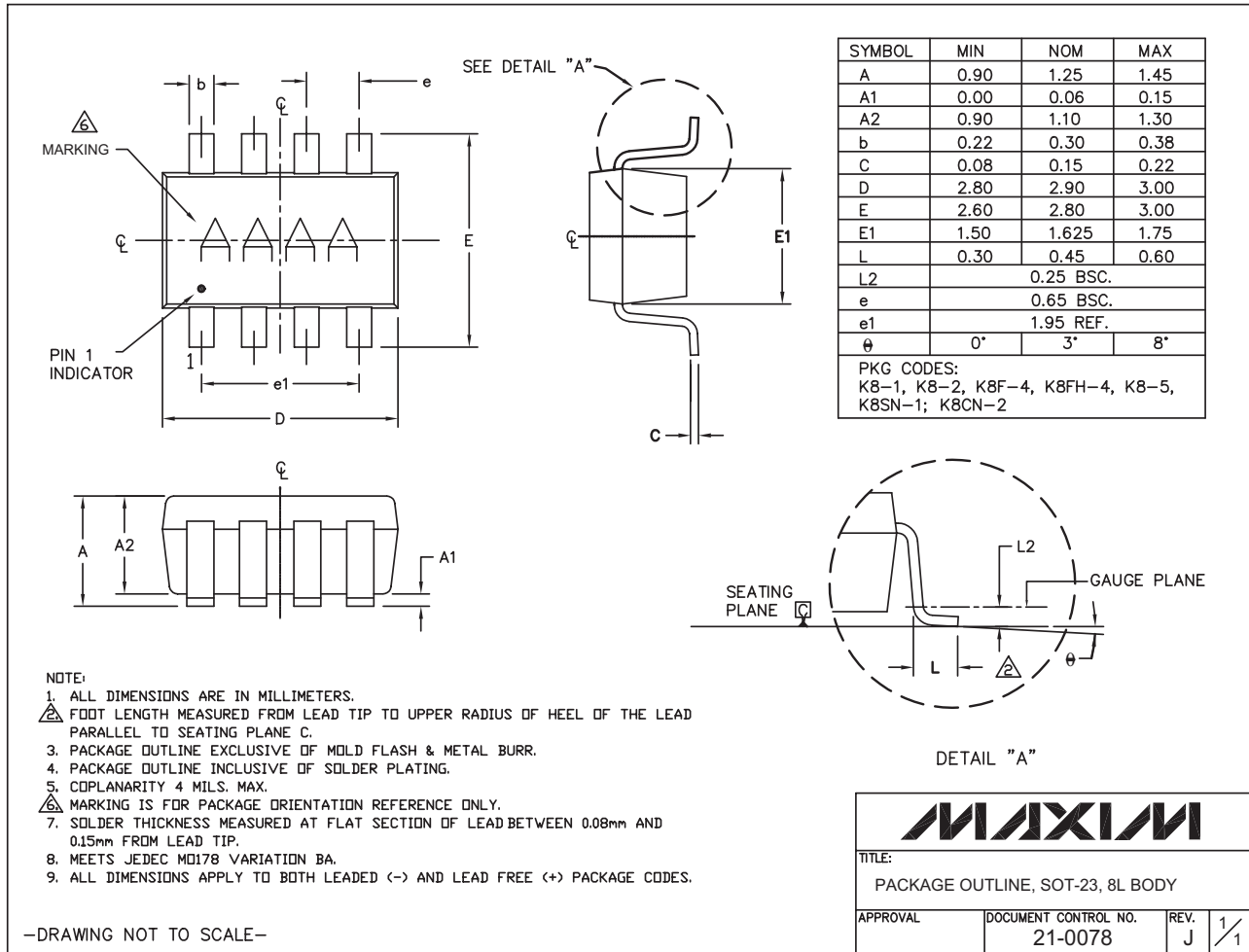

-DRAWING NOT TO SCALE-

| | | |
|--|---------------------------------|------------|
| MAXIM | | |
| TITLE: PACKAGE OUTLINE, SOT-23, 8L BODY | | |
| APPROVAL | DOCUMENT CONTROL NO. 21-0078 | REV. J 1/1 |

200kHz, 4μA, Rail-to-Rail I/O Op Amps with Shutdown

Package Information (continued)

For the latest package outline information and land patterns, go to www.maxim-ic.com/packages. Note that a "+", "#", or "-" in the package code indicates RoHS status only. Package drawings may show a different suffix character, but the drawing pertains to the package regardless of RoHS status.

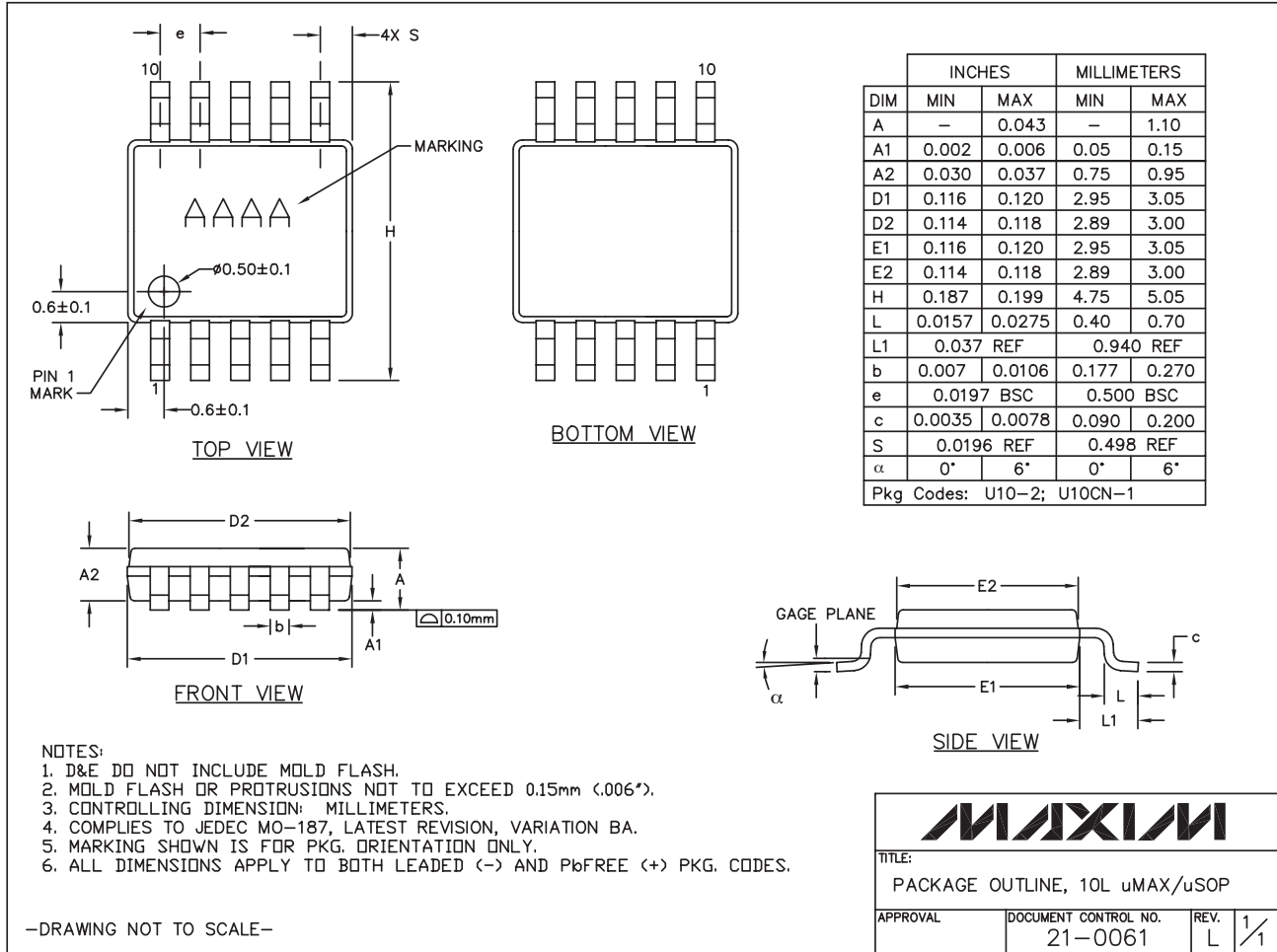

10LMAX.EPS

200kHz, 4 μ A, Rail-to-Rail I/O Op Amps with Shutdown

Revision History

| REVISION NUMBER | REVISION DATE | DESCRIPTION | PAGES CHANGED |
|-----------------|---------------|-------------------|---------------|
| 2 | 10/10 | Added WLP package | 1, 2, 9, 11 |

MAX9910-MAX9913

Maxim cannot assume responsibility for use of any circuitry other than circuitry entirely embodied in a Maxim product. No circuit patent licenses are implied. Maxim reserves the right to change the circuitry and specifications without notice at any time.

Maxim Integrated Products, 120 San Gabriel Drive, Sunnyvale, CA 94086 408-737-7600 _____ 17