



# MAX8770/MAX8771/MAX8772 Dual-Phase, Quick-PWM Controller for IMVP-6+ CPU Core Power Supplies

MAX8770/MAX8771/MAX8772

## General Description

The MAX8770/MAX8771/MAX8772 are 2/1-phase interleaved Quick-PWM™ step-down VID power-supply controllers for notebook CPUs. True out-of-phase operation reduces input ripple current requirements and output voltage ripple while easing component selection and layout difficulties. The Quick-PWM control provides instantaneous response to fast load current steps. Active voltage positioning reduces power dissipation and bulk output capacitance requirements and allows ideal positioning compensation for tantalum, polymer, or ceramic bulk output capacitors.

The MAX8770/MAX8771/MAX8772 are intended for two different notebook CPU core applications: either bucking down the battery directly to create the core voltage, or else bucking down the +5V system supply. The single-stage conversion method allows this device to directly step down high-voltage batteries for the highest possible efficiency. Alternatively, 2-stage conversion (stepping down the +5V system supply instead of the battery) at higher switching frequency provides the minimum possible physical size.

A slew-rate controller allows controlled transitions between VID codes, controlled soft-start and shutdown, and controlled exit from suspend. A thermistor-based temperature sensor provides a programmable thermal-fault output (VRHOT). A power-monitor output (POUT) provides an analog voltage output proportional to the power consumed by the CPU. The MAX8770/MAX8771/MAX8772 include output undervoltage protection (UVP) and thermal protection, and the MAX8770/MAX8771 also include overvoltage protection (OVP). When any of these protection features detect a fault, the controller shuts down. A voltage-regulator power-OK (PWRGD) output indicates the output is in regulation. A clock enable (CLKEN) output provides proper system startup sequencing. Additionally, the MAX8771 has a phase-good (PHASEGD) output, and the MAX8770/MAX8772 includes true differential current sense.

The MAX8770/MAX8771/MAX8772 implement the Intel IMVP-6+ code set and the required IMVP-6+ control signals. The MAX8770/MAX8771/MAX8772 are available in a 40-pin TQFN package.

## Applications

- IMVP-6+ Core Supply
- Multiphase CPU Core Supply
- Voltage-Positioned, Step-Down Converters
- Notebook/Desktop Computers
- Blade Servers

Intel is a registered trademark of Intel, Corp.

Quick-PWM is a trademark of Maxim Integrated Products, Inc.



## Features

- ◆ Single/Dual-Phase, Quick-PWM Controller
- ◆ ±0.4% V<sub>OUT</sub> Accuracy Over Line, Load, and Temperature
- ◆ 7-Bit On-Board DAC: 0 to +1.5000V Output Adjust Range
- ◆ Dynamic Phase Selection Optimizes Active/Sleep Efficiency
- ◆ Transient Phase Overlap Reduces Output Capacitance
- ◆ Integrated Boost Switches
- ◆ Active Voltage Positioning with Adjustable Gain
- ◆ Programmable 200kHz to 600kHz Switching Frequency
- ◆ Accurate Current Balance and Current Limit
- ◆ Adjustable Slew-Rate Control
- ◆ Power-Good (PWRGD), Clock Enable (CLKEN), Power Monitor (POUT) and Thermal Fault (VRHOT) Outputs
- ◆ Phase Fault (PHASEGD) Output (MAX8771)
- ◆ Drives Large Synchronous Rectifier MOSFETs
- ◆ 4V to 26V Battery-Input-Voltage Range
- ◆ Output OV Protection (MAX8770/MAX8771)
- ◆ UV and Thermal-Fault Protection
- ◆ Power Sequencing and Timing
- ◆ Soft-Startup and Soft-Shutdown

## Ordering Information

PART	TEMP	PIN-PACKAGE
MAX8770GTL+	-40°C to +105°C	40 Thin QFN 6mm x 6mm
MAX8771GTL+	-40°C to +105°C	40 Thin QFN 6mm x 6mm
MAX8772GTL+	-40°C to +105°C	40 Thin QFN 6mm x 6mm

+Denotes lead-free package.

Pin Configuration appears at end of data sheet.

# MAX8770/MAX8771/MAX8772 Dual-Phase, Quick-PWM Controller for IMVP-6+ CPU Core Power Supplies

## ABSOLUTE MAXIMUM RATINGS

V <sub>CC</sub> , V <sub>DD</sub> to GND .....	-0.3V to +6V	BST <sub>-</sub> to GND .....	-0.3V to +36V
D0–D6, CSP <sub>-</sub> to GND .....	-0.3V to +6V	LX <sub>-</sub> to BST <sub>-</sub> .....	-6V to +0.3V
CSN12 (MAX8771) to GND .....	-0.3V to +6V	BST <sub>-</sub> to V <sub>DD</sub> .....	-0.3V to +30V
CSN <sub>-</sub> (MAX8770/MAX8772) to GND .....	-0.3V to +6V	DH <sub>-</sub> to LX <sub>-</sub> .....	-0.3V to V <sub>BST-</sub> +0.3V
PHASEGD (MAX8771) to GND .....	-0.3V to +6V	REF Short Circuit to GND .....	Continuous
THRM, VRHOT, CLKEN to GND .....	-0.3V to +6V	Continuous Power Dissipation	
TIME, PWRGD, POUT to GND .....	-0.3V to V <sub>CC</sub> + 0.3V	40-Pin 6mm x 6mm Thin QFN	
REF, FB, CCV, CCI to GND .....	-0.3V to V <sub>CC</sub> + 0.3V	(derate 23.2mW/°C above +70°C) .....	2051mW
SHDN to GND (Note 1) .....	-0.3V to +14V	Operating Temperature Range .....	-40°C to +105°C
TON to GND .....	-0.3V to +30V	Junction Temperature .....	+150°C
DPRSLPVR, DPRSTP, PSI to GND .....	-0.3V to +6V	Storage Temperature Range .....	-65°C to +165°C
GNDS, PGND <sub>-</sub> to GND .....	-0.3V to +0.3V	Lead Temperature (soldering, 10s) .....	+300°C
DL <sub>-</sub> to PGND <sub>-</sub> .....	-0.3V to V <sub>DD</sub> + 0.3V		

**Note 1:** SHDN may be forced to 12V for the purpose of debugging prototype boards using the no-fault test mode, which disables fault protection and disables overlapping operation.

Stresses beyond those listed under “Absolute Maximum Ratings” may cause permanent damage to the device. These are stress ratings only, and functional operation of the device at these or any other conditions beyond those indicated in the operational sections of the specifications is not implied. Exposure to absolute maximum rating conditions for extended periods may affect device reliability.

## ELECTRICAL CHARACTERISTICS

(Circuit of Figure 1. V<sub>DD</sub> = V<sub>CC</sub> = V<sub>SHDN</sub> = V<sub>PSI</sub> = V<sub>DPRSTP</sub> = 5V, DPRSLPVR = GNDS = PGND<sub>-</sub> = GND, V<sub>FB</sub> = V<sub>CCI</sub> = V<sub>CSP-</sub> = V<sub>CSN-</sub> = 1.200V, D0–D6 set for 1.20V (D0–D6 = 0001100). **T<sub>A</sub> = 0°C to +85°C**, unless otherwise specified. Typical values are at T<sub>A</sub> = +25°C.)

PARAMETER	SYMBOL	CONDITIONS	MIN	TYP	MAX	UNITS	
<b>PWM CONTROLLER</b>							
Input Voltage Range		V <sub>CC</sub> , V <sub>DD</sub>	4.5		5.5	V	
DC Output-Voltage Accuracy	V <sub>OUT</sub>	Includes load-regulation error (Note 2)	DAC codes from 0.8375V to 1.500V	-0.4		+0.4	%
			DAC codes from 0.500V to 0.825V	-4		+4	mV
			DAC codes below 0.4875V	-10		+10	
Boot Voltage	V <sub>BOOT</sub>		1.19	1.20	1.21	V	
GNDS Input Range	V <sub>GNDS</sub>		-200		+200	mV	
GNDS Gain	A <sub>GNDS</sub>	ΔV <sub>OUT</sub> /ΔV <sub>GNDS</sub> , -200mV ≤ V <sub>GNDS</sub> ≤ +200mV	0.95	1.00	1.05	V/V	
GNDS Input Bias Current	I <sub>GNDS</sub>		-25	-15	+2	μA	
FB Input Bias Current	I <sub>FB</sub>	CSP <sub>-</sub> = CSN <sub>-</sub> for both enabled phases	-2		+2	μA	
On-Time Accuracy (Note 3)	t <sub>ON</sub>	V <sub>IN</sub> = 12V V <sub>FB</sub> = V <sub>CCI</sub> = 1.2V	R <sub>TON</sub> = 96.75kΩ	142	167	192	ns
			R <sub>TON</sub> = 200kΩ	300	333	366	
			R <sub>TON</sub> = 303.25kΩ	425	500	575	
TON Shutdown Input Current		SHDN = 0, V <sub>IN</sub> = 26V, V <sub>CC</sub> = V <sub>DD</sub> = 0 or 5V		0.01	0.1	μA	
Minimum FB and CCI Voltages for Pseudo-Fixed-Frequency Operation		Switching frequency is reduced if FB and/or CCI are less than this value		0.2	0.25	V	
Minimum Off-Time	t <sub>OFF(MIN)</sub>	(Note 3)		300	375	ns	

# MAX8770/MAX8771/MAX8772 Dual-Phase, Quick-PWM Controller for IMVP-6+ CPU Core Power Supplies

## ELECTRICAL CHARACTERISTICS (continued)

(Circuit of Figure 1.  $V_{DD} = V_{CC} = \overline{VSHDN} = \overline{VPSI} = \overline{VDPRSTP} = 5V$ ,  $DPRSLPVR = GNDS = PGND_{-} = GND$ ,  $V_{FB} = V_{CCI} = V_{CSP_{-}} = V_{CSN_{-}} = 1.200V$ ,  $D0-D6$  set for 1.20V ( $D0-D6 = 0001100$ ).  $T_A = 0^{\circ}C$  to  $+85^{\circ}C$ , unless otherwise specified. Typical values are at  $T_A = +25^{\circ}C$ .)

PARAMETER	SYMBOL	CONDITIONS	MIN	TYP	MAX	UNITS	
TIME Slew-Rate Accuracy		$R_{TIME} = 71.5k\Omega$ (12.5mV/ $\mu$ s nominal)	-10		+10	%	
		$R_{TIME} = 35.7k\Omega$ (25mV/ $\mu$ s nominal) to 178k $\Omega$ (5mV/ $\mu$ s nominal)	-15		+15		
		$\overline{DPRSTP} = \text{high}$ , $DPRSLPVR = \text{high}$ , $R_{TIME} = 35.7k\Omega$ to 178k $\Omega$ , $SR = 6.25mV/\mu$ s nominal to 1.25mV/ $\mu$ s nominal	-20		+20		
		Startup and shutdown, $R_{TIME} = 35.7k\Omega$ (3.125mV/ $\mu$ s nominal) to 178k $\Omega$ (0.625mV/ $\mu$ s nominal)	-20		+20		
<b>BIAS AND REFERENCE</b>							
Quiescent Supply Current ( $V_{CC}$ )	$I_{CC}$	Measured at $V_{CC}$ , FB forced above the regulation point, $DPRSLPVR = V_{CC}$		5	10	mA	
Quiescent Supply Current ( $V_{DD}$ )	$I_{DD}$	Measured at $V_{DD}$ , FB forced above the regulation point, $DPRSLPVR = V_{CC}$		0.01	1	$\mu$ A	
Shutdown Supply Current ( $V_{CC}$ )	$I_{CC(SHDN)}$	Measured at $V_{CC}$ , $\overline{SHDN} = GND$		0.01	1	$\mu$ A	
Shutdown Supply Current ( $V_{DD}$ )	$I_{DD(SHDN)}$	Measured at $V_{DD}$ , $\overline{SHDN} = GND$		0.01	1	$\mu$ A	
Reference Voltage	$V_{REF}$	$V_{CC} = 4.5V$ to $5.5V$ , $I_{REF} = 0$	1.986	2.000	2.014	V	
Reference Load Regulation	$\Delta V_{REF}$	$I_{REF} = 0$ to $500\mu$ A	-2	-0.2		mV	
		$I_{REF} = -100\mu$ A to 0		0.21	6.2		
<b>FAULT PROTECTION</b>							
Output Overvoltage Protection Threshold (MAX8770/MAX8771 Only)	$V_{OVP}$	Measured at FB with respect to unloaded output voltage; rising edge; PWM mode or skip mode after output reaches the regulation voltage	250	300	350	mV	
		Measured at FB; rising edge	Skip mode and output have not reached the regulation voltage	1.75	1.80	1.85	V
			Minimum OVP threshold		0.8		
Output Overvoltage-Propagation Delay (MAX8770/MAX8771 Only)	$t_{OVP}$	FB forced 25mV above trip threshold		10		$\mu$ s	
Output Undervoltage Protection Threshold	$V_{UVP}$	Measured at FB with respect to unloaded output voltage	-450	-400	-350	mV	
Output Undervoltage Propagation Delay	$t_{UVP}$	FB forced 25mV below trip threshold		10		$\mu$ s	
$\overline{CLKEN}$ Startup Delay (Boot Time Period)	$t_{BOOT}$	Measured from the time when FB reaches the boot target voltage based on the slew rate set by $R_{TIME}$	20	60	100	$\mu$ s	

MAX8770/MAX8771/MAX8772

# MAX8770/MAX8771/MAX8772 Dual-Phase, Quick-PWM Controller for IMVP-6+ CPU Core Power Supplies

MAX8770/MAX8771/MAX8772

## ELECTRICAL CHARACTERISTICS (continued)

(Circuit of Figure 1.  $V_{DD} = V_{CC} = \overline{VSHDN} = \overline{VPSI} = \overline{VDPRSTP} = 5V$ ,  $DPRSLPVR = GNDS = PGND_{-} = GND$ ,  $V_{FB} = V_{CCI} = V_{CSP_{-}} = V_{CSN_{-}} = 1.200V$ , D0–D6 set for 1.20V (D0–D6 = 0001100).  $T_A = 0^{\circ}C$  to  $+85^{\circ}C$ , unless otherwise specified. Typical values are at  $T_A = +25^{\circ}C$ .)

PARAMETER	SYMBOL	CONDITIONS		MIN	TYP	MAX	UNITS
PWRGD, PHASEGD Startup Delay	$t_{PWRGD}$	Measured at startup from the time when $\overline{CLKEN}$ goes low		3	5	8	ms
$\overline{CLKEN}$ , PWRGD Threshold		Measured at FB with respect to unloaded output voltage	Lower threshold, falling edge (undervoltage)	-350	-300	-250	mV
		15mV hysteresis (typ)	Upper threshold, rising edge (overvoltage)	+150	+200	+250	
$\overline{CLKEN}$ , PWRGD, PHASEGD Delay		FB forced 25mV outside the PWRGD trip thresholds			10		$\mu s$
$\overline{CLKEN}$ , PWRGD, PHASEGD Transition Blanking Time	$t_{BLANK}$	Measured from the time when FB reaches the target voltage based on the slew rate set by RTIME			20		$\mu s$
PHASEGD Transition Blanking Time	$t_{PHASEGD}$	Number of DH2 pulses from when phase 2 is enabled			32		Cycles
PHASEGD Window Comparator Thresholds		$V_{CCI}$ , FB), $0.4V \leq V_{FB} \leq 1.5V$	Lower threshold, $0.6V_{FB}$ nominal	-20		+20	mV
		15mV hysteresis (typ)	Upper threshold, $1.4V_{FB}$ nominal	-20		+20	
$\overline{CLKEN}$ , PWRGD, PHASEGD Output Low Voltage		$I_{SINK} = 3mA$				0.4	V
$\overline{CLKEN}$ , PWRGD, PHASEGD Leakage Current		High state, $\overline{CLKEN}$ , PWRGD, PHASEGD forced to 5V				1	$\mu A$
$\overline{VRHOT}$ Trip Threshold		Measured at THRM, with respect to $V_{CC}$ ; falling edge, 115mV hysteresis (typ)		29.5	30	30.5	%
$\overline{VRHOT}$ Delay	$t_{\overline{VRHOT}}$	THRM forced 25mV below the $\overline{VRHOT}$ trip threshold; falling edge			10		$\mu s$
$\overline{VRHOT}$ Output On-Resistance	$R_{\overline{VRHOT}}$	Low state			3.5	11	$\Omega$
$\overline{VRHOT}$ Leakage Current		High state. $\overline{VRHOT}$ forced to 5V				1	$\mu A$
THRM Input Leakage				-100		+100	nA
$V_{CC}$ Undervoltage Lockout Threshold	$V_{UVLO(VCC)}$	Rising edge, 50mV hysteresis, $DL_{-}$ pulled low below this level		4.1	4.25	4.45	V
$V_{CC}$ Power-On Reset Threshold		Falling edge, typical hysteresis = 1.1V, faults cleared and $DL_{-}$ forced high when $V_{CC}$ falls below this level			1.8		V
Thermal Shutdown Threshold	$T_{SHDN}$	Hysteresis = $15^{\circ}C$			160		$^{\circ}C$

# MAX8770/MAX8771/MAX8772 Dual-Phase, Quick-PWM Controller for IMVP-6+ CPU Core Power Supplies

## ELECTRICAL CHARACTERISTICS (continued)

(Circuit of Figure 1.  $V_{DD} = V_{CC} = \overline{VSHDN} = \overline{VPSI} = \overline{VDPRSTP} = 5V$ ,  $DPRSLPVR = GNDS = PGND_{-} = GND$ ,  $V_{FB} = V_{CCI} = V_{CSP_{-}} = V_{CSN_{-}} = 1.200V$ ,  $D0-D6$  set for 1.20V ( $D0-D6 = 0001100$ ).  $T_A = 0^{\circ}C$  to  $+85^{\circ}C$ , unless otherwise specified. Typical values are at  $T_A = +25^{\circ}C$ .)

PARAMETER	SYMBOL	CONDITIONS	MIN	TYP	MAX	UNITS
<b>DROOP AND BALANCE</b>						
DC Droop Amplifier Offset			-1.0		+1.0	mV
DC Droop Amplifier Transconductance	$G_{m(FB)}$	$\Delta I_{FB}/(\Sigma \Delta V_{CS})$ , $V_{FB} = V_{CSN_{-}} = 1.2V$ , $V_{CSP_{-}} - V_{CSN_{-}} = 0$ to $+60mV$	590	600	610	$\mu S$
Current-Balance Preamplifier Offset		$[V(CSP1, CSN_{-}) - V(CSP2, CSN_{-})]$ at $I_{CCI} = 0$	-1.0		+1.0	mV
Current-Balance Amplifier Transconductance	$G_{m(CCI)}$	$\Delta I_{CCI}/\Delta [V(CSP1, CSN_{-}), V(CSP2, CSN_{-})]$ $CCI = FB = CSN_{-} = 0.45V$ to $1.5V$ , and $V(CSP_{-}, CSN_{-}) = -10mV$ to $+10mV$		200		$\mu S$
<b>CURRENT LIMIT</b>						
Valley Current-Limit Threshold (Positive)	$V_{LIMIT}$	$CSP_{-} - CSN_{-}$	19.5	22.5	25.5	mV
Valley Current-Limit Threshold (Negative)		$CSP_{-}, CSN_{-}$	-35	-30	-25	mV
Zero Crossing Threshold	$V_{ZX}$	$PGND1 - LX1$ , $DPRSLPVR = high$ (skip mode)		2.5		mV
Current-Sense Input Current		$CSP_{-}$	-0.2		+0.2	$\mu A$
		$CSN_{-}$	-0.2		+0.2	
		$CSN12$ (MAX8771)	-0.4		+0.4	
Common-Sense Common-Mode Input Range		$CSP_{-} - CSN_{-}$		0	2	V
Phase 2 Disable Threshold Gate Drivers		$CSP2$	3	$V_{CC} - 1$	$V_{CC} - 0.4$	
<b>GATE DRIVERS</b>						
DH_ Gate Driver On-Resistance	$R_{ON(DH_{-})}$	BST_ -LX_ forced to 5V	High state (pullup)	0.9	2.5	$\Omega$
			Low state (pulldown)	0.7	2.5	
DL_ Gate Driver On-Resistance	$R_{ON(DL_{-})}$		High state (pullup)	0.7	2.0	$\Omega$
			Low state (pulldown)	0.25	0.5	
DH_ Gate Driver Source/Sink Current	$I_{DH}$	DH_ forced to 2.5V, BST_ - LX_ forced to 5V		2.2		A
DL_ Gate Driver Source Current	$I_{DL(SOURCE)}$	DL_ forced to 2.5V		2.7		A
DL_ Gate Driver Sink Current	$I_{DL(SINK)}$	DL_ forced to 2.5V		8		A
Driver Propagation Delay		DH_ low to DL_ high	18	25		ns
		DL_ low to DH_ high	9	20		
DL_ Transition Time		DL_ falling, $C_{DL_{-}} = 3nF$		20		ns
		DL_ rising, $C_{DL_{-}} = 3nF$		20		
DH_ Transition Time		DH_ falling, $C_{DH_{-}} = 3nF$		20		ns
		DH_ rising, $C_{DH_{-}} = 3nF$		20		

# MAX8770/MAX8771/MAX8772 Dual-Phase, Quick-PWM Controller for IMVP-6+ CPU Core Power Supplies

MAX8770/MAX8771/MAX8772

## ELECTRICAL CHARACTERISTICS (continued)

(Circuit of Figure 1.  $V_{DD} = V_{CC} = \overline{V_{SHDN}} = \overline{V_{PSI}} = \overline{V_{DPRSTP}} = 5V$ ,  $DPRSLPVR = GND_S = PGND\_ = GND$ ,  $V_{FB} = V_{CCI} = V_{CSP\_} = V_{CSN\_} = 1.200V$ , D0–D6 set for 1.20V (D0–D6 = 0001100).  $T_A = 0^{\circ}C$  to  $+85^{\circ}C$ , unless otherwise specified. Typical values are at  $T_A = +25^{\circ}C$ .)

PARAMETER	SYMBOL	CONDITIONS	MIN	TYP	MAX	UNITS
Internal Boost Charging Switch On-Resistance		$V_{DD}$ to $BST\_$		10	20	$\Omega$
<b>POWER MONITOR</b>						
Power-Monitor Output Voltage for Typical HFM Conditions		$V_{FB} - V_{GND_S} = 1.200V$ , $\Sigma\Delta V_{CS} = 30mV$	2.08	2.16	2.24	V
Power-Monitor Gain Referred to Feedback Voltage		$\Sigma\Delta V_{CS} = 30mV$	1.72	1.80	1.88	V/V
Power-Monitor Gain Referred to $\Sigma V$ (CSP_, CSN)		$V_{FB} - V_{GND_S} = 1.200V$ , $T_A = +25^{\circ}C$ to $+85^{\circ}C$	70.5	72	73.5	V/V
Power-Monitor Load Regulation		Sourcing: $I_{POUT} = 0$ to $500\mu A$	-6			$\mu V/\mu A$
		Sinking: $I_{POUT} = 0$ to $100\mu A$	50			mV
<b>LOGIC AND I/O</b>						
Logic Input High Voltage	$V_{IH}$	$\overline{SHDN}$ , $DPRSLPVR$ , rising edge, hysteresis = $200mV$	1.2	1.7	2.3	V
$\overline{SHDN}$ No-Fault Level		To enable no-fault mode	11		13	V
Low-Voltage Logic Input High Voltage	$V_{IHLV}$	D0–D6, $\overline{PSI}$ , $\overline{DRPSTP}$	0.67			V
Low-Voltage Logic Input Low Voltage	$V_{ILLV}$	D0–D6, $\overline{PSI}$ , $\overline{DRPSTP}$			0.33	V
Logic Input Current		$\overline{SHDN}$ , $\overline{PSI}$ , $DPRSLPVR$ , D0–D6 = 0 to 5V	-1		+1	$\mu A$

# MAX8770/MAX8771/MAX8772 Dual-Phase, Quick-PWM Controller for IMVP-6+ CPU Core Power Supplies

## ELECTRICAL CHARACTERISTICS

(Circuit of Figure 1.  $V_{DD} = V_{CC} = \overline{VSHDN} = \overline{VPSI} = \overline{VDPRSTP} = 5V$ ,  $DPRSLPVR = GNDS = PGND_{-} = GND$ ,  $V_{FB} = V_{CCI} = V_{CSP_{-}} = V_{CSN_{-}} = 1.200V$ , D0–D6 set for 1.20V (D0–D6 = 0001100).  $T_A = -40^{\circ}C$  to  $+105^{\circ}C$ , unless otherwise specified. Typical values are at  $T_A = +25^{\circ}C$ .) (Note 4)

PARAMETER	SYMBOL	CONDITIONS		MIN	TYP	MAX	UNITS
<b>PWM CONTROLLER</b>							
Input Voltage Range		$V_{CC}, V_{DD}$		4.5		5.5	V
DC Output Voltage Accuracy	$V_{OUT}$	Includes load-regulation error (Note 2)	DAC codes from 0.8375V to 1.500V	-0.6		+0.6	%
			DAC codes from 0.500V to 0.825V	-6		+6	mV
			DAC codes below 0.4875V	-15		+15	
Boot Voltage	$V_{BOOT}$			1.182		1.218	V
GNDS Input Range	$V_{GNDS}$			-200		+200	mV
GNDS Gain	$A_{GNDS}$	$\Delta V_{OUT}/\Delta V_{GNDS}$ , $-200mV \leq V_{GNDS} \leq +200mV$		0.95		1.05	V/V
On-Time Accuracy (Note 3)	$t_{ON}$	$V_{IN} = 12V$ $V_{FB} = V_{CCI} = 1.2V$	$R_{TON} = 96.75k\Omega$	142		192	ns
			$R_{TON} = 200k\Omega$	300		366	
			$R_{TON} = 303.25k\Omega$	425		575	
Minimum FB and CCI Voltages for Pseudo-Fixed-Frequency Operation		Switching frequency is reduced if FB and/or CCI are less than this value				0.25	V
Minimum Off-Time	$t_{OFF(MIN)}$	(Note 3)				375	ns
TIME Slew-Rate Accuracy		$R_{TIME} = 71.5k\Omega$ (12.5mV/ $\mu s$ nominal)		-10		+10	%
		$R_{TIME} = 35.7k\Omega$ (25mV/ $\mu s$ nominal) to 178k $\Omega$ (5mV/ $\mu s$ nominal)		-15		+15	
		DPRSTP = high, DPRSLPVR = high, $R_{TIME} = 35.7k\Omega$ to 178k $\Omega$ , SR = 6.25mV/ $\mu s$ nominal to 1.25mV/ $\mu s$ nominal		-20		+20	
		Startup and shutdown, $R_{TIME} = 35.7k\Omega$ (3.125mV/ $\mu s$ nominal) to 178k $\Omega$ (0.625mV/ $\mu s$ nominal)		-20		+20	
<b>BIAS AND REFERENCE</b>							
Quiescent Supply Current ( $V_{CC}$ )	$I_{CC}$	Measured at $V_{CC}$ , FB forced above the regulation point, DPRSLPVR = $V_{CC}$				10	mA
Quiescent Supply Current ( $V_{DD}$ )	$I_{DD}$	Measured at $V_{DD}$ , FB forced above the regulation point, DPRSLPVR = $V_{CC}$				1	$\mu A$
Shutdown Supply Current ( $V_{CC}$ )	$I_{CC(SHDN)}$	Measured at $V_{CC}$ , SHDN = GND				1	$\mu A$
Shutdown Supply Current ( $V_{DD}$ )	$I_{DD(SHDN)}$	Measured at $V_{DD}$ , SHDN = GND				1	$\mu A$
Reference Voltage	$V_{REF}$	$V_{CC} = 4.5V$ to $5.5V$ , $I_{REF} = 0$		1.98		2.02	V
Reference Load Regulation	$\Delta V_{REF}$	$I_{REF} = 0$ to $500\mu A$		-2			mV
		$I_{REF} = -100\mu A$ to 0				6.2	

MAX8770/MAX8771/MAX8772



# MAX8770/MAX8771/MAX8772 Dual-Phase, Quick-PWM Controller for IMVP-6+ CPU Core Power Supplies

MAX8770/MAX8771/MAX8772

## ELECTRICAL CHARACTERISTICS (continued)

(Circuit of Figure 1.  $V_{DD} = V_{CC} = V_{SHDN} = V_{PS1} = V_{DPRSTP} = 5V$ ,  $DPRSLPVR = GNDS = PGND_{-} = GND$ ,  $V_{FB} = V_{CCI} = V_{CSP_{-}} = V_{CSN_{-}} = 1.200V$ , D0–D6 set for 1.20V (D0–D6 = 0001100).  $T_A = -40^{\circ}C$  to  $+105^{\circ}C$ , unless otherwise specified. Typical values are at  $T_A = +25^{\circ}C$ .) (Note 4)

PARAMETER	SYMBOL	CONDITIONS		MIN	TYP	MAX	UNITS
<b>FAULT PROTECTION</b>							
Output Overvoltage Protection Threshold (MAX8770/MAX8771 Only)	V <sub>OVP</sub>	Measured at FB with respect to unloaded output voltage, rising edge, PWM mode, or skip mode after output reaches the regulation voltage		250		350	mV
		Measured at FB, rising edge	Skip mode and output have not reached the regulation voltage	1.75		1.85	V
Output Undervoltage Protection Threshold	V <sub>UVP</sub>	Measured at FB with respect to unloaded output voltage		-450		-350	mV
CLKEN Startup Delay (Boot Time Period)	t <sub>BOOT</sub>	Measured from the time when FB reaches the boot target voltage based on the slew rate set by R <sub>TIME</sub>		20		100	μs
PWRGD, PHASEGD Startup Delay	t <sub>PWRGD</sub>	Measured at startup from the time when CLKEN goes low		3		8	ms
CLKEN, PWRGD Threshold		Measured at FB with respect to unloaded output voltage	Lower threshold, falling edge (undervoltage)	-350		-250	mV
		15mV hysteresis (typ)	Upper threshold, rising edge (overvoltage)	+150		+250	
PHASEGD Window Comparator Thresholds		V(CCI,FB), 0.4V ≤ V(FB) ≤ 1.5V	Lower threshold, 0.6V <sub>FB</sub> nominal	-20		+20	mV
		15mV hysteresis (typ)	Upper threshold, 1.4V <sub>FB</sub> nominal	-20		+20	
CLKEN, PWRGD, PHASEGD Output Low Voltage		I <sub>SINK</sub> = 3mA				0.4	V
VRHOT Trip Threshold	V <sub>HOT</sub>	Measured at THRM, with respect to V <sub>CC</sub> , falling edge, 115mV hysteresis (typ)		29.5		30.5	%
VRHOT Output On-Resistance	R <sub>VRHOT</sub>	Low state				11	Ω
V <sub>CC</sub> Undervoltage Lockout Threshold	V <sub>UVLO(VCC)</sub>	Rising edge, 50mV hysteresis, DL <sub>-</sub> pulled low below this level		4.1		4.45	V
<b>DROOP AND BALANCE</b>							
DC Droop Amplifier Offset				-1.5		+1.5	mV
DC Droop Amplifier Transconductance	G <sub>m(FB)</sub>	ΔI <sub>FB</sub> /(ΣΔV <sub>CS</sub> ), V <sub>FB</sub> = V <sub>CSN<sub>-</sub></sub> = 1.2V, V <sub>CSP<sub>-</sub></sub> - V <sub>CSN<sub>-</sub></sub> = 0 to +60mV		580		620	μs
Current-Balance Preampifier Offsets		[V(CSPI, CSN <sub>-</sub> ) - V(CPS2, CSN <sub>-</sub> )] at I <sub>CCI</sub> = 0		-1.5		+1.5	mV



# MAX8770/MAX8771/MAX8772 Dual-Phase, Quick-PWM Controller for IMVP-6+ CPU Core Power Supplies

## ELECTRICAL CHARACTERISTICS (continued)

(Circuit of Figure 1.  $V_{DD} = V_{CC} = V_{SHDN} = V_{PSI} = V_{DPRSTP} = 5V$ ,  $DPRSLPVR = GNDS = PGND_{-} = GND$ ,  $V_{FB} = V_{CCI} = V_{CSP_{-}} = V_{CSN_{-}} = 1.200V$ ,  $D0-D6$  set for 1.20V ( $D0-D6 = 0001100$ ).  $T_A = -40^{\circ}C$  to  $+105^{\circ}C$ , unless otherwise specified. Typical values are at  $T_A = +25^{\circ}C$ .) (Note 4)

PARAMETER	SYMBOL	CONDITIONS	MIN	TYP	MAX	UNITS
<b>CURRENT LIMIT</b>						
Valley Current-Limit Threshold (Positive)	$V_{LIMIT}$	$CSP_{-} - CSN_{-}$	18.5		26.5	mV
Valley Current-Limit Threshold (Negative)		$CSP_{-} - CSN_{-}$	-36		-24	mV
Current-Sense Common-Mode Input Range		$CSP_{-}, CSN_{-}$	0		2	V
Phase 2 Disable Threshold		CSP2	3		$V_{CC} - 0.4$	V
<b>GATE DRIVERS</b>						
DH_ Gate Driver On-Resistance	$R_{ON(DH_{-})}$	BST_ – LX_ forced to 5V	High state (pullup)		2.5	$\Omega$
			Low state (pulldown)		2.5	
DL_ Gate Driver On-Resistance	$R_{ON(DL_{-})}$	High state (pullup)		2.0	$\Omega$	
		Low state (pulldown)		0.5		
Driver Propagation Delay		DH_ Low to DL_ High	15		ns	
		DL_ Low to DH_ High	9			
Internal Boost Charging Switch On-Resistance		$V_{DD}$ to BST_			20	$\Omega$
<b>POWER MONITOR</b>						
Power-Monitor Output Voltage for Typical HFM Conditions		$V_{FB} - V_{GNDS} = 1.200V$ , $\Sigma\Delta V_{CS} = 30mV$	2.04		2.28	V
Power-Monitor Gain Referred to Feedback Voltage		$\Sigma\Delta V_{CS} = 30mV$	1.70		1.90	V/V
Power-Monitor Gain Referred to $\Sigma V(CSP_{-}, CSN_{-})$		$V_{FB} - V_{GNDS} = 1.200V$	70		74	V/V
Power-Monitor Load Regulation		Sourcing: $I_{POUT} = 0$ to $500\mu A$	-6			$\mu V/\mu A$
<b>LOGIC AND I/O</b>						
Logic-Input High Voltage	$V_{IH}$	$\overline{SHDN}$ , $\overline{DPRSLPVR}$ , rising edge, hysteresis = 200mV	1.2		2.3	V
Low-Voltage Logic-Input High	$V_{IHLV}$	$D0-D6$ , $\overline{PSI}$ , $\overline{DRPSTP}$	0.67			V
Low-Voltage Logic-Input Low	$V_{ILLV}$	$D0-D6$ , $\overline{PSI}$ , $\overline{DRPSTP}$			0.33	V

**Note 2:** DC output accuracy specifications refer to the trip level of the error amplifier. The output voltage has a DC regulation higher than the trip level by 50% of the output ripple. When pulse skipping, the output rises by approximately 1.5% when transitioning from continuous conduction to no load.

**Note 3:** On-time and minimum off-time specifications are measured from 50% to 50% at the  $DH_{-}$  and  $DH_{-}$  pins, with  $LX_{-}$  forced to GND,  $BST_{-}$  forced to 5V, and a 500pF capacitor from  $DH_{-}$  to  $LX_{-}$  to simulate external MOSFET gate capacitance. Actual in-circuit times may be different due to MOSFET switching speeds.

**Note 4:** Specifications to  $T_A = -40^{\circ}C$  and  $+105^{\circ}C$  are guaranteed by design and are not production tested.

# MAX8770/MAX8771/MAX8772 Dual-Phase, Quick-PWM Controller for IMVP-6+ CPU Core Power Supplies

## Typical Operating Characteristics

(Circuit of Figure 1.  $V_{IN} = 12V$ ,  $V_{CC} = V_{DD}$ ,  $SHDN = \overline{PSI} = 5V$ ,  $DPRSLPVR = GND$ ,  $D0-D6$  set for 1.1500V,  $T_A = 25^\circ C$ , unless otherwise specified.)

MAX8770/MAX8771/MAX8772

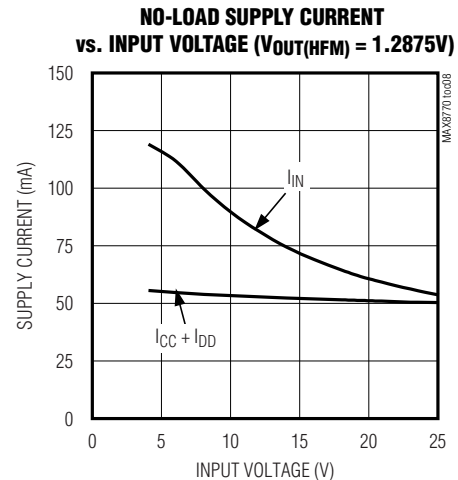
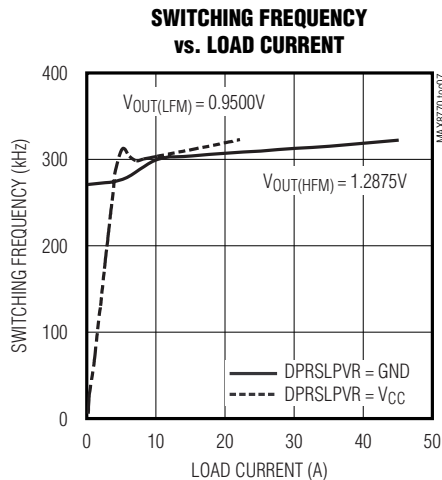
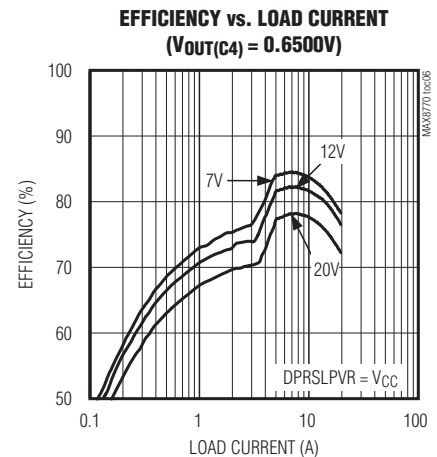
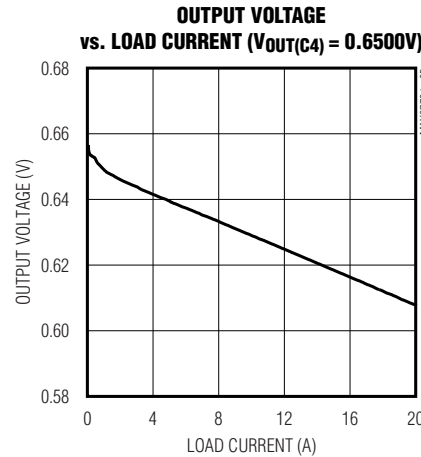
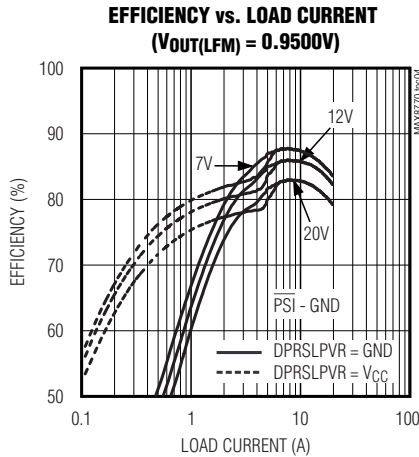
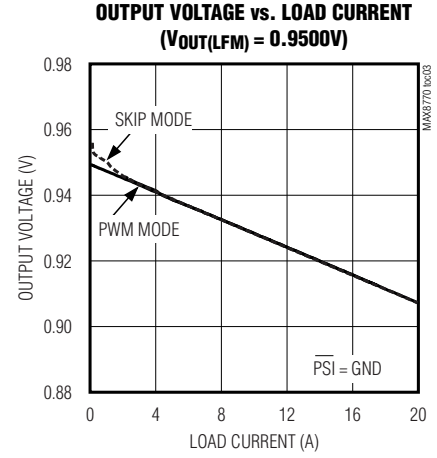
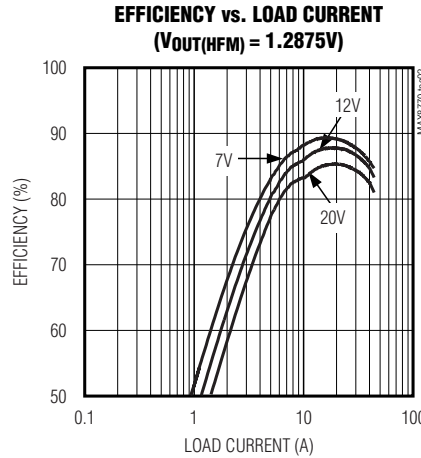
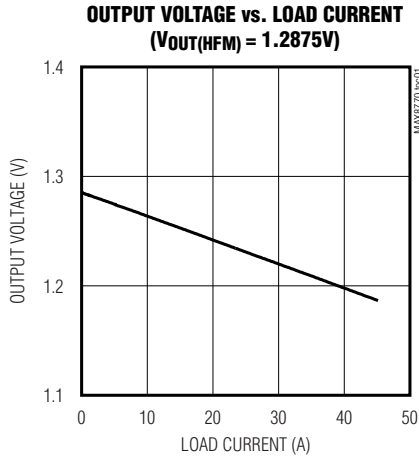

# MAX8770/MAX8771/MAX8772 Dual-Phase, Quick-PWM Controller for IMVP-6+ CPU Core Power Supplies

## Typical Operating Characteristics (continued)

(Circuit of Figure 1.  $V_{IN} = 12V$ ,  $V_{CC} = V_{DD}$ ,  $\overline{SHDN} = \overline{PSI} = 5V$ ,  $DPRSLPVR = GND$ ,  $D0-D6$  set for 1.1500V,  $T_A = 25^\circ C$ , unless otherwise specified.)

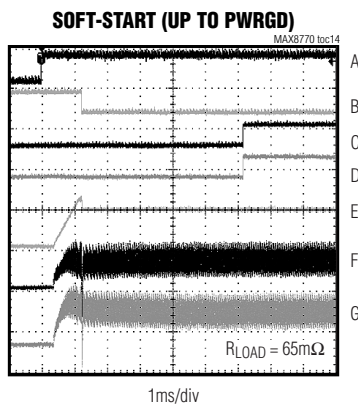
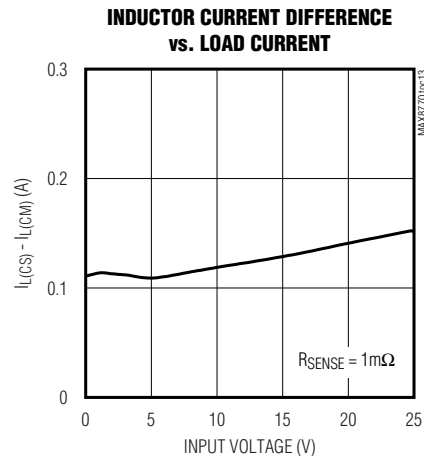
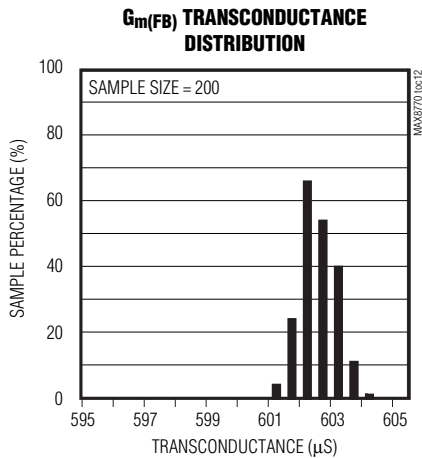
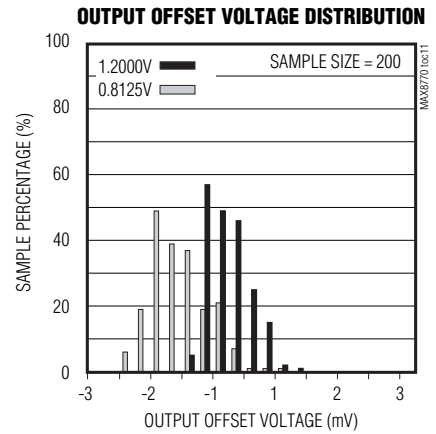
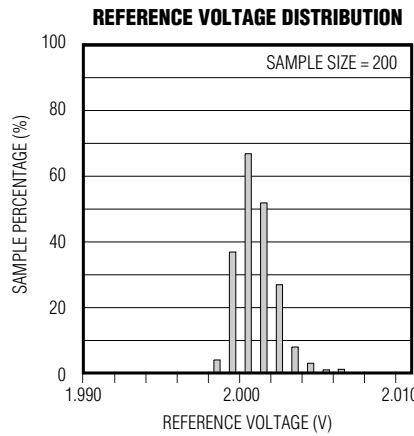
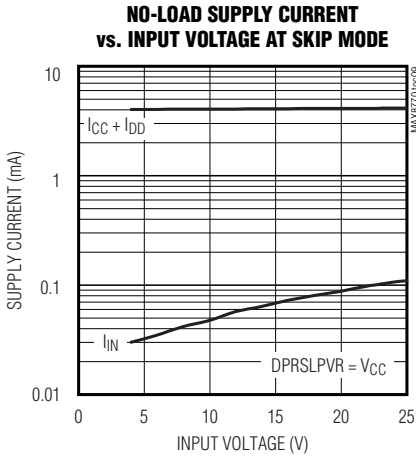

A.  $\overline{SHDN}$ , 5V/div  
B.  $\overline{CLKEN}$ , 10V/div  
C.  $\overline{PWRGD}$ , 10V/div  
D.  $\overline{PHASEGD}$ , 10V/div  
E.  $V_{OUT}$ , 1V/div  
F.  $I_{LX1}$ , 10A/div  
G.  $I_{LX2}$ , 10V/div

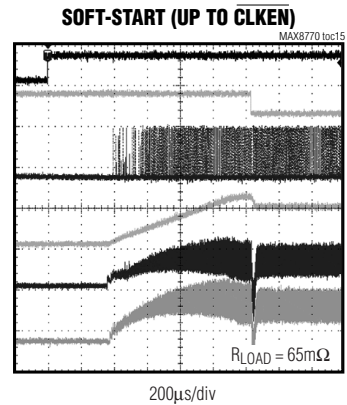

A.  $\overline{SHDN}$ , 5V/div  
B.  $\overline{CLKEN}$ , 10V/div  
C.  $I_{LX1}$ , 10V/div  
D.  $V_{OUT}$ , 1V/div  
E.  $I_{LX1}$ , 10A/div  
F.  $I_{LX2}$ , 10V/div

# MAX8770/MAX8771/MAX8772 Dual-Phase, Quick-PWM Controller for IMVP-6+ CPU Core Power Supplies

## Typical Operating Characteristics (continued)

(Circuit of Figure 1.  $V_{IN} = 12V$ ,  $V_{CC} = V_{DD}$ ,  $\overline{SHDN} = \overline{PSI} = 5V$ ,  $DPRSLPVR = GND$ , D0–D6 set for 1.1500V,  $T_A = 25^\circ C$ , unless otherwise specified.)

**SHUTDOWN WAVEFORMS**

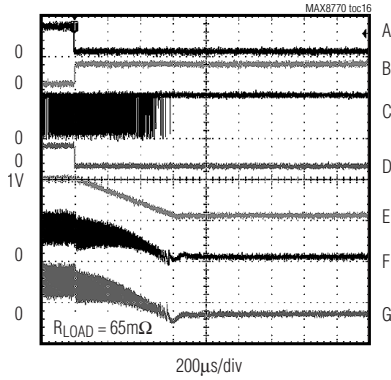

A.  $\overline{SHDN}$ , 5V/div  
 B. CLKEN, 10V/div  
 C. DL1, 10V/div  
 D. PWRGD, 10V/div  
 E.  $V_{OUT}$ , 1V/div  
 F.  $I_{LX1}$ , 10A/div  
 G.  $I_{LX2}$ , 10V/div

**HFM LOAD TRANSIENT**  
**( $V_{OUT(HFM)} = 1.2875V$ )**

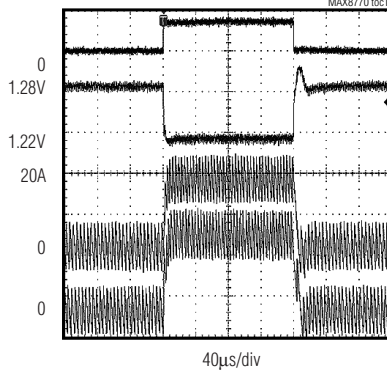

A.  $I_{OUT} = 5A$  TO  $36A$ , 10A/div  
 B.  $V_{OUT}$ , 50mV/div  
 C.  $I_{LX1}$ , 10A/div  
 D.  $I_{LX2}$ , 10A/div

**LFM LOAD TRANSIENT**  
**( $V_{OUT(LFM)} = 0.9500V$ )**

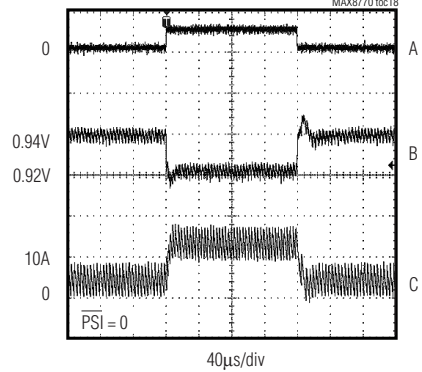

A.  $I_{OUT} = 5A$  TO  $15A$ , 10A/div  
 B.  $V_{OUT}$ , 50mV/div  
 C.  $I_{LX1}$ , 10A/div  
 D.  $I_{LX2}$ , 10A/div

**ENTERING DEEPER SLEEP**  
**EXITING TO LFM**

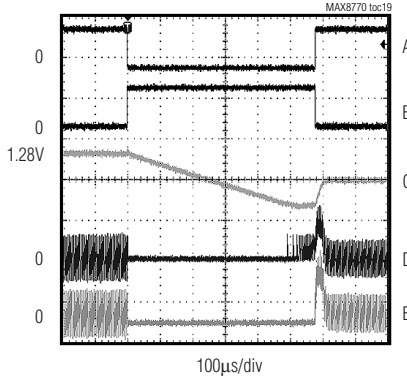

A.  $\overline{DPRSTP}$ , 5V/div  
 B.  $\overline{DPRSLPVR}$ , 5V/div  
 C.  $V_{OUT}$ , 500mV/div  
 $I_{OUT} = 2A$   
 D.  $I_{LX1}$ , 10A/div  
 E.  $I_{LX2}$ , 10A/div

**ENTERING DEEPER SLEEP**  
**EXITING TO NEAREST VID**

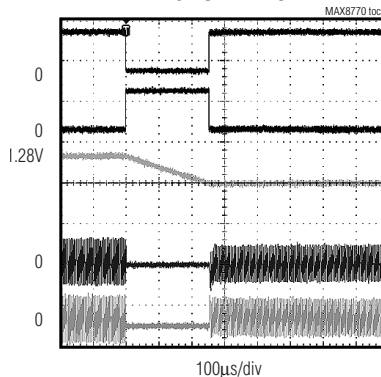

A.  $\overline{DPRSTP}$ , 5V/div  
 B.  $\overline{DPRSLPVR}$ , 5V/div  
 C.  $V_{OUT}$ , 500mV/div  
 $I_{OUT} = 2A$   
 D.  $I_{LX1}$ , 10A/div  
 E.  $I_{LX2}$ , 10A/div

**ENTERING DEEPER SLEEP**  
**EXITING TO LFM**

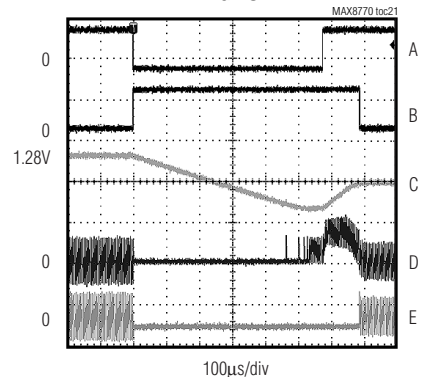

A.  $\overline{DPRSTP}$ , 5V/div  
 B.  $\overline{DPRSLPVR}$ , 5V/div  
 C.  $V_{OUT}$ , 500mV/div  
 $I_{OUT} = 2A$   
 D.  $I_{LX1}$ , 10A/div  
 E.  $I_{LX2}$ , 10A/div

MAX8770/MAX8771/MAX8772

# MAX8770/MAX8771/MAX8772 Dual-Phase, Quick-PWM Controller for IMVP-6+ CPU Core Power Supplies

## Typical Operating Characteristics (continued)

(Circuit of Figure 1.  $V_{IN} = 12V$ ,  $V_{CC} = V_{DD}$ ,  $SHDN = \overline{PSI} = 5V$ ,  $DPRSLPVR = GND$ ,  $D0-D6$  set for 1.1500V,  $T_A = 25^\circ C$ , unless otherwise specified.)

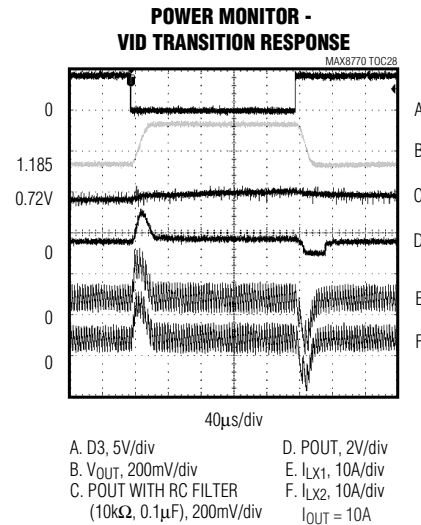
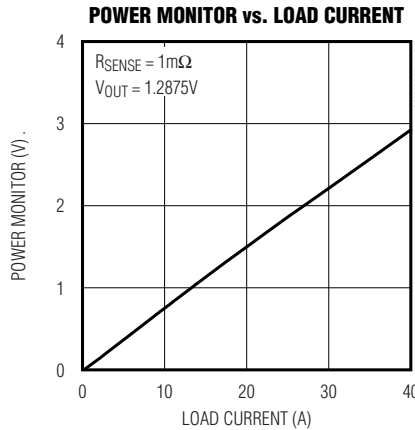
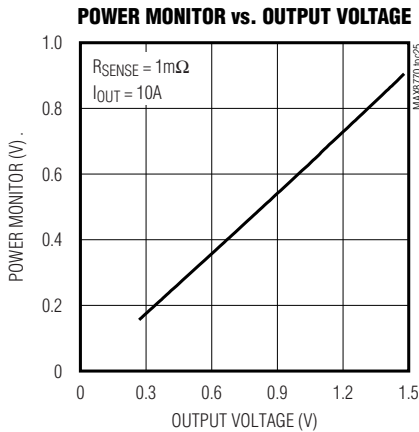
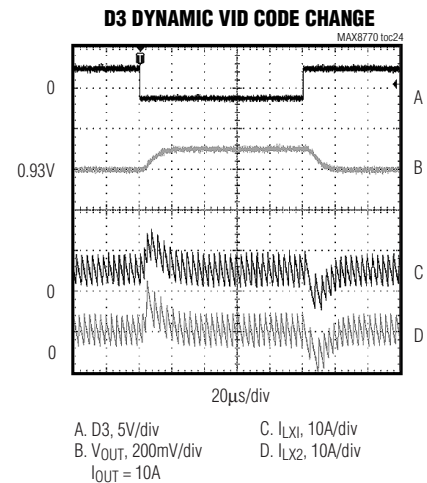
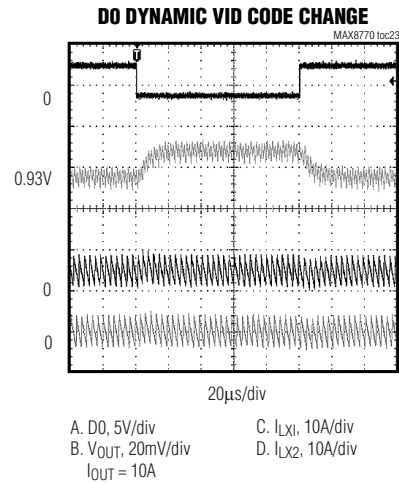
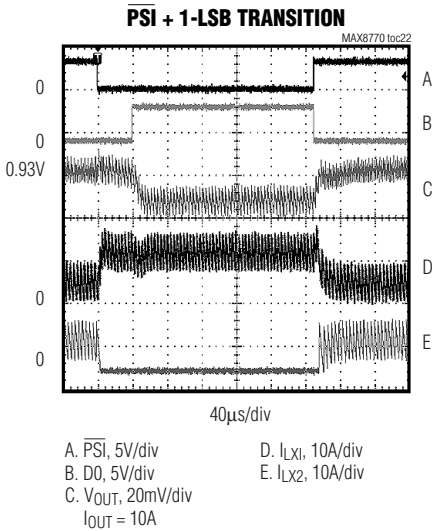

# MAX8770/MAX8771/MAX8772 Dual-Phase, Quick-PWM Controller for IMVP-6+ CPU Core Power Supplies

## Pin Description

MAX8770/MAX8771/MAX8772

PIN	NAME	FUNCTION															
1	$\overline{\text{CLKEN}}$	Clock-Enable Logic Output. This inverted logic output indicates when the output voltage sensed at FB is in regulation. $\overline{\text{CLKEN}}$ is forced low during VID transitions. Except during startup, $\overline{\text{CLKEN}}$ is the inverse of PWRGD. See the <i>Startup Timing Diagram</i> (Figure 9). When in pulse-skipping mode (DPRSLPVR high), the upper $\overline{\text{CLKEN}}$ threshold is disabled.															
2	PWRGD	Open-Drain, Power-Good Output. After output-voltage transitions, except during power-up and power-down, if FB is in regulation then PWRGD is high impedance. During startup, PWRGD is held low and continues to be low while the part is in boot mode and until 5ms (typ) after $\overline{\text{CLKEN}}$ goes low. PWRGD is forced low in shutdown. PWRGD is forced high impedance whenever the slew-rate controller is active (output-voltage transitions). When in pulse-skipping mode (DPRSLPVR high), the upper PWRGD threshold comparator is blanked. A pullup resistor on PWRGD causes additional finite shutdown current.															
3	$\overline{\text{PSI}}$	Logic Input to Indicate Power Usage. $\overline{\text{PSI}}$ and DPRSLPVR together determine the operating mode as shown in the truth table below. Blank the PWRGD upper threshold when the part is in skip mode. <b>The part is forced into full-phase PWM mode during startup, while in boot mode, during the transition from boot mode to VID mode and during shutdown:</b> <table border="1"> <thead> <tr> <th>DPRSLPVR</th> <th><math>\overline{\text{PSI}}</math></th> <th>Mode</th> </tr> </thead> <tbody> <tr> <td>1</td> <td>0</td> <td>Very low current (1-phase skip)</td> </tr> <tr> <td>1</td> <td>1</td> <td>Low current (approximately 3A) (1-phase skip)</td> </tr> <tr> <td>0</td> <td>0</td> <td>Intermediate power potential (1-phase PWM)</td> </tr> <tr> <td>0</td> <td>1</td> <td>Max power potential (2- or 1-phase PWM as configured at CSP2)</td> </tr> </tbody> </table>	DPRSLPVR	$\overline{\text{PSI}}$	Mode	1	0	Very low current (1-phase skip)	1	1	Low current (approximately 3A) (1-phase skip)	0	0	Intermediate power potential (1-phase PWM)	0	1	Max power potential (2- or 1-phase PWM as configured at CSP2)
DPRSLPVR	$\overline{\text{PSI}}$	Mode															
1	0	Very low current (1-phase skip)															
1	1	Low current (approximately 3A) (1-phase skip)															
0	0	Intermediate power potential (1-phase PWM)															
0	1	Max power potential (2- or 1-phase PWM as configured at CSP2)															
4	POUT	Power-Monitor Output: $V_{\text{POUT}} = K_{\text{PWR}} \times V(\text{CSN}_{\text{pm}}, \text{GNDS}) \times \Sigma V(\text{CSP}_{-}, \text{CSN}_{-})$ , where $K_{\text{PWR}}$ is the power monitor scale factor: $\text{CSN}_{\text{pm}} = \text{CSN}_{12}$ for MAX8771. $\text{CSN}_{\text{pm}} = \text{CSN}_{2}$ for MAX8770/MAX8772. POUT is zero in shutdown.															
5	$\overline{\text{VRHOT}}$	Open-Drain Output of Internal Comparator. $\overline{\text{VRHOT}}$ is pulled low when the voltage at THRM goes below 1.5V (30% of $V_{\text{CC}}$ ). $\overline{\text{VRHOT}}$ is high impedance in shutdown.															
6	THRM	Input of Internal Comparator. Connect the output of a resistor- and thermistor-divider (between $V_{\text{CC}}$ and GND) to THRM. Select the components such that the voltage at THRM falls below 1.5V (30% of $V_{\text{CC}}$ ) at the desired high temperature.															
7	TIME	Slew-Rate Adjustment Pin. Connect a resistor $R_{\text{TIME}}$ from TIME to GND to set the internal slew rate: $\text{Slew rate} = (12.5\text{mV}/\mu\text{s}) \times (71.5\text{k}\Omega / R_{\text{TIME}})$ where $R_{\text{TIME}}$ is between 35.7k $\Omega$ and 178k $\Omega$ . This slew rate applies to transitions into and out of the low-power pulse-skipping modes (and to the transition from boot mode to VID mode). The slew rate for startup and shutdown is 1/8 this value. If the VID DAC inputs are clocked, the slew rate for all other VID transitions is set by the rate at which they are clocked, up to a maximum slew rate equal to the one set by $R_{\text{TIME}}$ as defined above.															
8	TON	Switching-Frequency Setting Input. An external resistor between the input power source and TON sets the switching period ( $T_{\text{SW}} = 1/f_{\text{SW}}$ ) per phase according to the following equation: $T_{\text{SW}} = C_{\text{TON}} (R_{\text{TON}} + 6.5\text{k}\Omega)$ where $C_{\text{TON}} = 16.26\text{pF}$ . TON is high impedance in shutdown.															
9	CCV	Integrator Capacitor Connection. Connect a $470\text{pF} \times (2/\eta_{\text{TOTAL}}) \times 300\text{kHz}/f_{\text{SW}}$ capacitor from CCV to GND to set the integration time constant. The integrator is internally disabled when the part is in skip mode and the output is above regulation.															

# MAX8770/MAX8771/MAX8772 Dual-Phase, Quick-PWM Controller for IMVP-6+ CPU Core Power Supplies

## Pin Description (continued)

PIN	NAME	FUNCTION
10	CCI	Current-Balance Compensation. Connect a 470pF capacitor between CCI and the positive side of the feedback remote sense (or between CCI and GND). CCI is internally forced low in shutdown.
11	REF	2.0V Reference Output. Bypass to GND with a 1µF <b>maximum</b> low-ESR (ceramic) capacitor. Can source 500µA for external loads. Loading REF degrades OUT accuracy, according to the REF load-regulation error.
12	FB	Output of the DC-Voltage Positioning Transconductance Amplifier. Connect a resistor R <sub>FB</sub> between FB and the positive side of the feedback remote sense to set the DC steady-state droop based on the voltage-positioning gain requirement: $R_{FB} = R_{DROOP} / (R_{SENSE} \times G_{m(FB)})$ where R <sub>DROOP</sub> is the desired voltage-positioning slope and G <sub>m(FB)</sub> = 600µS (typ). R <sub>SENSE</sub> is the value of the current-sense resistors that are used to provide the (CSP <sub>-</sub> , CSN <sub>-</sub> ) current-sense voltages. If lossless sensing is used, R <sub>SENSE</sub> = R <sub>L</sub> . In this case, consider making R <sub>FB</sub> a resistor network that includes an NTC thermistor to minimize the temperature dependence of the voltage-positioning slope. DC droop can be disabled by shorting FB to the positive remote-sense point. FB is high impedance in shutdown.
13	GNDS	Feedback Remote-Sense Input, Negative Side. Normally connected to GND directly at the load. GNDS internally connects to a transconductance amplifier that fine tunes the output voltage— compensating for voltage drops from the regulator ground to the load ground.
14	CSP2	Positive Input of the Output Current Sense of Phase 2. This pin should be connected to the positive side of the output current-sensing resistor or the filtering capacitor if the DC resistance of the output inductor is utilized for current sensing. Tie this pin to V <sub>CC</sub> for 1-phase operation.
15	CSN12 (MAX8771)	Combined Negative Current-Sense Input for Phases 1 and 2. The negative current-sense signals of the two phases (taken from the negative sides of the output current-sensing resistors or the filtering capacitors if the DC resistances of the output inductors are utilized for current sensing) are resistively averaged, and the resulting signal is connected to this pin. Pay special attention to board layout to maximize current-sensing accuracy; either place the sense elements (inductors for lossless sensing or sense resistors) close to each other, or equalize the layout paths and PC board trace resistances between the sense elements and the remote load. CSN12 is also used as the voltage input to the power monitor.
	CSN2 (MAX8770 /MAX8772)	Negative Input of the Output Current Sense of Phase 2. This pin should be connected to the negative side of the output current-sensing resistor or the filtering capacitor if the DC resistance of the output inductor is utilized for current sensing. CSN2 is also used as the voltage input to the power monitor.
16	CSP1 (MAX8771)	Positive Input of the Output Current Sense of Phase 1. This pin should be connected to the positive side of the output current-sensing resistor or the filtering capacitor if the DC resistance of the output inductor is utilized for current sensing.
	CSN1 (MAX8770/ MAX8772)	Negative Input of the Output Current Sense of Phase 1. This pin should be connected to the negative side of the output current-sensing resistor or the filtering capacitor if the DC resistance of the output inductor is utilized for current sensing.

MAX8770/MAX8771/MAX8772



# MAX8770/MAX8771/MAX8772 Dual-Phase, Quick-PWM Controller for IMVP-6+ CPU Core Power Supplies

## Pin Description (continued)

PIN	NAME	FUNCTION
17	PHASEGD (MAX8771)	Open-Drain, Phase-Good Output. Used to signal the system that one of the two phases either has a fault condition or is not matched with the other. Detection is done by identifying the need for a large on-time difference between phases in order to achieve or move towards current balance. PHASEGD is low in shutdown. PHASEGD is forced high impedance whenever the slew-rate controller is active (output-voltage transitions). PHASEGD is forced high impedance while in 1-phase operation (DPRSLPVR = high or $\overline{PST}$ = low).
	CSP1 (MAX8770 MAX8772)	Positive Input of the Output Current Sense of Phase 1. This pin should be connected to the positive side of the output current-sensing resistor or the filtering capacitor if the DC resistance of the output inductor is utilized for current sensing.
18	GND	Analog Ground. Connect to the exposed backside pad and low-current analog ground terminations.
19	V <sub>CC</sub>	Controller Supply Voltage. Connect to a 4.5V to 5.5V source. Bypass to GND with 1μF minimum.
20	BST2	Boost Flying-Capacitor Connection for the DH2 high-side gate driver. An internal switch between V <sub>DD</sub> and BST2 charges the flying capacitor during the time the low-side FET is on.
21	DH2	Phase-2, High-Side Gate-Driver Output. DH2 swings from LX2 to BST2. Low in shutdown.
22	LX2	Phase-2 Inductor Connection. LX2 is the internal lower supply rail for the DH2 high-side gate driver. Also used as an input to the phase 2's zero-crossing comparator.
23	PGND2	Power Ground for Phase 2. Ground connection for the DL2 driver. Also used as an input to phase 2's zero crossing comparator.
24	DL2	Phase-2, Low-Side Gate-Driver Output. DL2 swings from PGND2 to V <sub>DD</sub> . DL2 is forced high in shutdown. DL2 is also forced high when an output overvoltage fault is detected, overriding any negative current-limit condition that may be present. DL2 is forced low in skip mode (DPRSLPVR high) after an inductor current zero crossing (PGND2 - LX2) is detected. DL2 is forced low in 1-phase mode (TWO - PH = low).
25	V <sub>DD</sub>	Supply Voltage Input for the DL1 and DL2 Drivers. V <sub>DD</sub> is also the supply voltage used to internally recharge the BST1, BST2 flying capacitors during the off-times of the respective phases. Connect V <sub>DD</sub> to the 4.5V to 5.5V system supply voltage. Bypass V <sub>DD</sub> to PGND1 and PGND2 with a 1μF each or greater ceramic capacitors.
26	DL1	Phase 1, Low-Side Gate-Driver Output. DL1 swings from PGND1 to V <sub>DD</sub> . DL1 is forced high in shutdown. DL1 is also forced high when an output overvoltage fault is detected, overriding any negative current-limit condition that may be present. DL1 is forced low in skip mode (DPRSLPVR high) whenever an inductor current zero crossing (PGND1 - LX1) is detected.
27	PGND1	Power Ground for Phase 1. Ground connection for the DL1 driver. Also used as an input to the phase 1's zero crossing comparator.
28	LX1	Phase 1 Inductor Connection. LX1 is the internal lower supply rail for the DH1 high-side gate driver. Also used as an input to the phase-1's zero-crossing comparator.
29	DH1	Phase 1 High-Side Gate-Driver Output. DH1 swings from LX1 to BST1. Low in shutdown.
30	BST1	Boost Flying Capacitor Connection for the DH1 High-Side Gate Driver. An internal switch between V <sub>DD</sub> and BST1 charges the flying capacitor during the time the low-side FET is on.

MAX8770/MAX8771/MAX8772

# MAX8770/MAX8771/MAX8772 Dual-Phase, Quick-PWM Controller for IMVP-6+ CPU Core Power Supplies

## Pin Description (continued)

PIN	NAME	FUNCTION															
31–37	D0–D6	Low-Voltage VID DAC Code Input. The D0–D6 inputs do not have internal pullups. These 1.0V logic inputs are designed to interface directly with the CPU. The output voltage is set by the VID code indicated by the logic-level voltages on D0–D6 (see Table 4).															
38	$\overline{\text{SHDN}}$	Shutdown Control Input. This input cannot withstand the battery voltage. Connect to V <sub>CC</sub> for normal operation. Connect to ground to put the IC into its 1μA max shutdown state. During startup, the output voltage is ramped up to the boot voltage slowly at a slew rate that is 1/8 the slew rate set by the TIME resistor. During the transition from normal operation to shutdown, the output voltage is ramped down at the same slow slew rate. Forcing $\overline{\text{SHDN}}$ to 11V~13V disables both OVP and UVP protection circuits, clears the fault latch, disables transient phase overlap, and disables the BST_ charging switches. Do not connect $\overline{\text{SHDN}}$ to > 13V.															
39	DPRSLPVR	Logic Input to Indicate Power Usage. $\overline{\text{PSI}}$ and DPRSLPVR together determine the operating mode as shown in the truth table below. The PWRGD upper threshold is blanked when the part is in skip mode. <b>The part is forced into full-phase PWM mode during startup, while in boot mode, during the transition from boot mode to VID mode, and during shutdown.</b> <table border="1" style="margin-left: 20px;"> <thead> <tr> <th>DPRSLPVR</th> <th><math>\overline{\text{PSI}}</math></th> <th>Mode</th> </tr> </thead> <tbody> <tr> <td>1</td> <td>0</td> <td>Very low current (1-phase skip)</td> </tr> <tr> <td>1</td> <td>1</td> <td>Low current (approximately 3A) (1-phase skip)</td> </tr> <tr> <td>0</td> <td>0</td> <td>Intermediate power potential (1-phase PWM)</td> </tr> <tr> <td>0</td> <td>1</td> <td>Max power potential (full-phase PWM: number of phases by CSP2)</td> </tr> </tbody> </table>	DPRSLPVR	$\overline{\text{PSI}}$	Mode	1	0	Very low current (1-phase skip)	1	1	Low current (approximately 3A) (1-phase skip)	0	0	Intermediate power potential (1-phase PWM)	0	1	Max power potential (full-phase PWM: number of phases by CSP2)
DPRSLPVR	$\overline{\text{PSI}}$	Mode															
1	0	Very low current (1-phase skip)															
1	1	Low current (approximately 3A) (1-phase skip)															
0	0	Intermediate power potential (1-phase PWM)															
0	1	Max power potential (full-phase PWM: number of phases by CSP2)															
40	$\overline{\text{DPRSTP}}$	1.0V Logic-Input Signal. This signal from the system is usually the logical complement of the DPRSLPVR signal. However, there is a special condition during C4 exit when both $\overline{\text{DPRSTP}}$ and DPRSLPVR could temporarily be simultaneously high. If this happens, the slew rate reduces to 1/4 of the normal (R <sub>TIME</sub> -based) slew rate for the duration of this condition. The slew rate returns to normal when this condition is exited. Note that only DPRSLPVR and $\overline{\text{PSI}}$ (but <u>not</u> $\overline{\text{DPRSTP}}$ ) determine the mode of operation (PWM vs. skip) and the number of active phases: <table border="1" style="margin-left: 20px;"> <thead> <tr> <th>DPRSLPVR</th> <th><math>\overline{\text{DPRSTP}}</math></th> <th>Functionality</th> </tr> </thead> <tbody> <tr> <td>0</td> <td>0</td> <td>Normal slew rate, number of phases set by <math>\overline{\text{PSI}}</math> and CSP2 (DPRSLPVR low → <math>\overline{\text{DPRSTP}}</math> is ignored)</td> </tr> <tr> <td>0</td> <td>1</td> <td>Normal slew rate, number of phases set by <math>\overline{\text{PSI}}</math> and CSP2 (DPRSLPVR low → <math>\overline{\text{DPRSTP}}</math> is ignored)</td> </tr> <tr> <td>1</td> <td>0</td> <td>Normal slew rate, 1-phase skip mode</td> </tr> <tr> <td>1</td> <td>1</td> <td>Slew rate reduced to 1/4 of normal, 1-phase skip mode</td> </tr> </tbody> </table>	DPRSLPVR	$\overline{\text{DPRSTP}}$	Functionality	0	0	Normal slew rate, number of phases set by $\overline{\text{PSI}}$ and CSP2 (DPRSLPVR low → $\overline{\text{DPRSTP}}$ is ignored)	0	1	Normal slew rate, number of phases set by $\overline{\text{PSI}}$ and CSP2 (DPRSLPVR low → $\overline{\text{DPRSTP}}$ is ignored)	1	0	Normal slew rate, 1-phase skip mode	1	1	Slew rate reduced to 1/4 of normal, 1-phase skip mode
DPRSLPVR	$\overline{\text{DPRSTP}}$	Functionality															
0	0	Normal slew rate, number of phases set by $\overline{\text{PSI}}$ and CSP2 (DPRSLPVR low → $\overline{\text{DPRSTP}}$ is ignored)															
0	1	Normal slew rate, number of phases set by $\overline{\text{PSI}}$ and CSP2 (DPRSLPVR low → $\overline{\text{DPRSTP}}$ is ignored)															
1	0	Normal slew rate, 1-phase skip mode															
1	1	Slew rate reduced to 1/4 of normal, 1-phase skip mode															
EP	EP	Exposed Backside Pad. Connect the exposed backside pad to AGND.															

MAX8770/MAX8771/MAX8772

# MAX8770/MAX8771/MAX8772 Dual-Phase, Quick-PWM Controller for IMVP-6+ CPU Core Power Supplies

MAX8770/MAX8771/MAX8772

**Table 1. Component Selection for Standard Applications**

DESIGNATION	1.2875V/36A COMPONENTS (FIGURE 1)	1.1500V/44A COMPONENTS (FIGURE 1)	0.9000V/9A COMPONENTS (FIGURE 12)
Input Voltage Range	7V to 24V	7V to 24V	7V to 24V
VID Output Voltage (D6–D0)	1.2875V (D6–D0 = 0010001)	1.1500V (D6–D0 = 0011100)	0.9000V (D6–D0 = 0110000)
Load Line	-2.1mV/A	-2.1mV/A	-5.1mV/A
Maximum Load Current	36A	44A	9A
Inductor (per Phase)	0.36μH, 0.8mΩ NEC/Tokin MPC1055LR36	0.33μH, 0.82mΩ Panasonic ETQP5LR33XFC	0.56μH, 1.3mΩ NEC/Tokin MPC1040LR56
Switching Frequency	300kHz (R <sub>TON</sub> = 200kΩ)	300kHz (R <sub>TON</sub> = 200kΩ)	300kHz (R <sub>TON</sub> = 200kΩ)
High-Side MOSFET (N <sub>H</sub> , per Phase)	Siliconix (1) Si7892ADP	Siliconix (1) Si7892ADP	Siliconix (1) Si7892ADP
Low-Side MOSFET (N <sub>L</sub> , per Phase)	Siliconix (2) Si7336ADP	Siliconix (2) Si7336ADP	Siliconix (1) Si7336ADP
Total Input Capacitance (C <sub>IN</sub> )	(4) 10μF, 25V Taiyo Yuden TMK432BJ106KM or TDK C4532X5R1E106M	(4) 10μF, 25V Taiyo Yuden TMK432BJ106KM or TDK C4532X5R1E106M	(2) 10μF, 25V Taiyo Yuden TMK432BJ106KM or TDK C4532X5R1E106M
Total Output Capacitance (C <sub>OUT</sub> )	(4) 330μF, 2.5V, 6mΩ Panasonic EEFSX0D0D331XR	(4) 330μF, 2.5V, 6mΩ Panasonic EEFSX0D0D331XR	(2) 330μF, 2.5V, 6mΩ Panasonic EEFSX0D0D331XR
Current-Sense Resistor (R <sub>CS</sub> , per Phase)	1.0mΩ Panasonic ERJM1WTJ1M0U	1.0mΩ Panasonic ERJM1WTJ1M0U	2.0mΩ Panasonic ERJM1WTJ2M0U

**Table 2. Component Suppliers**

MANUFACTURER	WEBSITE	MANUFACTURER	WEBSITE
AVX	www.avxcorp.com	Pulse	www.pulseeng.com
BI Technologies	www.bitechnologies.com	Renesas	www.renesas.com
Central Semiconductor	www.centralsemi.com	Sanyo	www.secc.co.jp
Fairchild Semiconductor	www.fairchildsemi.com	Siliconix (Vishay)	www.vishay.com
International Rectifier	www.irf.com	Sumida	www.sumida.com
Kemet	www.kemet.com	Taiyo Yuden	www.t-yuden.com
NEC/Tokin	www.nec-tokin.com	TDK	www.component.tdk.com
Panasonic	www.panasonic.com	TOKO	www.tokoam.com

# MAX8770/MAX8771/MAX8772 Dual-Phase, Quick-PWM Controller for IMVP-6+ CPU Core Power Supplies

MAX8770/MAX8771/MAX8772

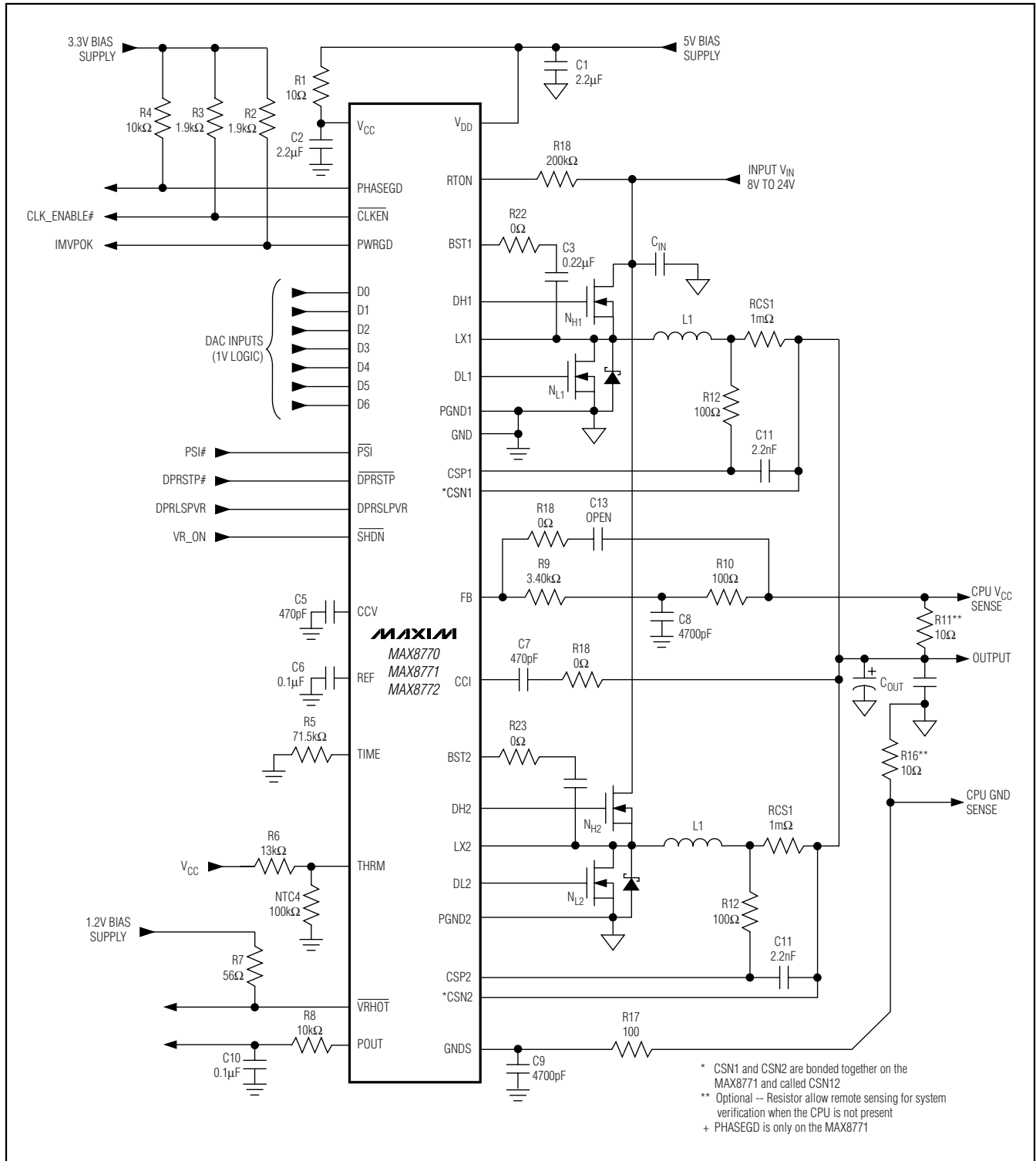

Figure 1. Standard 2-Phase IMVP-6 44A Application Circuit

# MAX8770/MAX8771/MAX8772 Dual-Phase, Quick-PWM Controller for IMVP-6+ CPU Core Power Supplies

## MAX8770/MAX8771/MAX8772 Detailed Description

### Free-Running, Constant On-Time PWM Controller with Input Feed-Forward

The Quick-PWM control architecture is a pseudo-fixed-frequency, constant-on-time, current-mode regulator with voltage feed-forward (Figure 2). This architecture relies on the output filter capacitor's ESR to act as the current-sense resistor, so the output ripple voltage pro-

vides the PWM ramp signal. The control algorithm is simple: the high-side switch on-time is determined solely by a one-shot whose period is inversely proportional to input voltage, and directly proportional to output voltage or the difference between the main and secondary inductor currents (see the *On-Time One-Shot* section). Another one-shot sets a minimum off-time. The on-time one-shot triggers when the error comparator goes low, the inductor current of the selected phase is below the valley current-limit threshold, and the minimum off-time one-shot times out. The controller maintains 180° out-of-

MAX8770/MAX8771/MAX8772

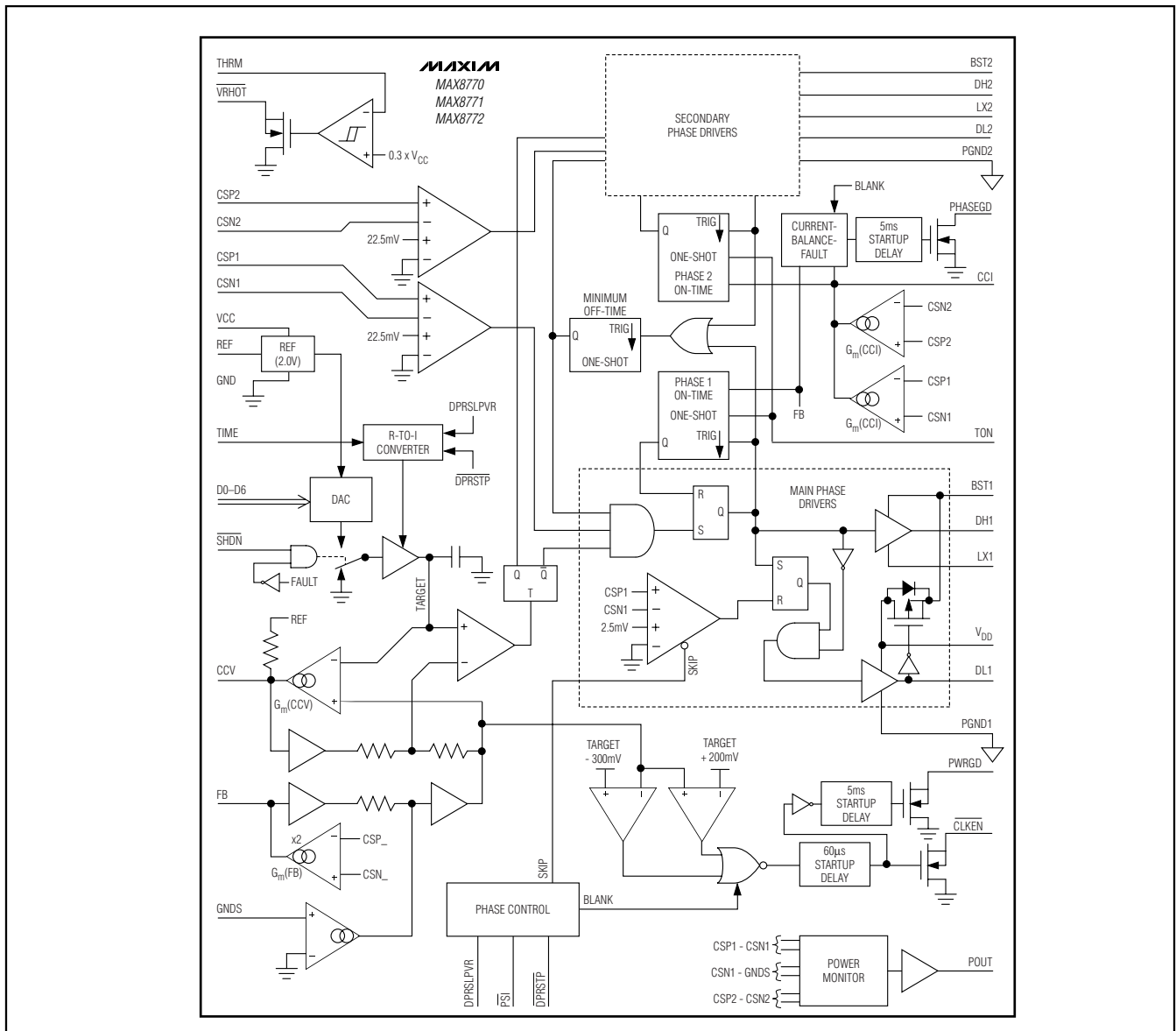

Figure 2. Functional Block Diagram

# MAX8770/MAX8771/MAX8772 Dual-Phase, Quick-PWM Controller for IMVP-6+ CPU Core Power Supplies

MAX8770/MAX8771/MAX8772

phase operation by alternately triggering the main and secondary phases after the error comparator drops below the output voltage set point.

### Dual 180° Out-of-Phase Operation

The two phases in the MAX8770/MAX8771/MAX8772 operate 180° out-of-phase to minimize input and output filtering requirements, reduce electromagnetic interference (EMI), and improve efficiency. This effectively lowers component count—reducing cost, board space, and component power requirements—making the MAX8770/MAX8771/MAX8772 ideal for high-power, cost-sensitive applications.

Typically, switching regulators provide power using only 1 phase instead of dividing the power among several phases. In these applications, the input capacitors must support high instantaneous current requirements. The high RMS ripple current can lower efficiency due to I<sup>2</sup>R power loss associated with the input capacitor's effective series resistance (ESR). Therefore, the system typically requires several low-ESR input capacitors in parallel to minimize input voltage ripple, to reduce ESR-related power losses, and to meet the necessary RMS ripple current rating.

With the MAX8770/MAX8771/MAX8772, the controller shares the current between two phases that operate 180° out-of-phase, so the high-side MOSFETs never turn on simultaneously during normal operation. The instantaneous input current of either phase is effectively halved, resulting in reduced input voltage ripple, ESR power loss, and RMS ripple current (see the *Input Capacitor Selection* section). Therefore, the same performance may be achieved with fewer or less-expensive input capacitors.

### +5V Bias Supply (V<sub>CC</sub> and V<sub>DD</sub>)

The Quick-PWM controller requires an external +5V bias supply in addition to the battery. Typically, this +5V bias supply is the notebook's 95% efficient +5V system supply. Keeping the bias supply external to the IC improves efficiency and eliminates the cost associated with the +5V linear regulator that would otherwise be needed to supply the PWM circuit and gate drivers. If stand-alone capability is needed, the +5V bias supply can be generated with an external linear regulator.

The +5V bias supply must provide V<sub>CC</sub> (PWM controller) and V<sub>DD</sub> (gate-drive power), so the maximum current drawn is:

$$I_{BIAS} = I_{CC} - f_{SW} (Q_{G(LOW)} + Q_{G(HIGH)})$$

where I<sub>CC</sub> is provided in the *Electrical Characteristics* Table, f<sub>SW</sub> is the switching frequency, and Q<sub>G(LOW)</sub> and Q<sub>G(HIGH)</sub> are the MOSFET data sheet's total gate-charge specification limits at V<sub>GS</sub> = 5V.

V<sub>IN</sub> and V<sub>DD</sub> can be tied together if the input power source is a fixed +4.5V to +5.5V supply. If the +5V bias supply is powered up prior to the battery supply, the enable signal (SHDN going from low to high) must be delayed until the battery voltage is present to ensure startup.

### Switching Frequency (TON)

Connect a resistor (R<sub>TON</sub>) between TON and V<sub>IN</sub> to set the switching period T<sub>SW</sub> = 1/f<sub>SW</sub>, per phase:

$$T_{SW} = C_{TON} (R_{TON} + 6.5k\Omega)$$

where C<sub>TON</sub> = 16.26pF.

A 96.75kΩ to 303.25kΩ corresponds to switching periods of 167ns (600kHz) to 500ns (200kHz), respectively. High-frequency (600kHz) operation optimizes the application for the smallest component size, trading off efficiency due to higher switching losses. This may be acceptable in ultra-portable devices where the load currents are lower and the controller is powered from a lower voltage supply. Low-frequency (200kHz) operation offers the best overall efficiency at the expense of component size and board space.

### On-Time One-Shot

The core of each phase contains a fast, low-jitter, adjustable one-shot that sets the high-side MOSFETs on-time. The one-shot for the main phase varies the on-time in response to the input and feedback voltages. The main high-side switch on-time is inversely proportional to the input voltage (V<sub>IN</sub>), and proportional to the feedback voltage (V<sub>FB</sub>):

$$t_{ON(MAIN)} = \frac{T_{SW} (V_{FB} + 0.075V)}{V_{IN}}$$

where the switching period (T<sub>SW</sub> = 1/f<sub>SW</sub>) is set by the resistor at the TON pin, and 0.075V is an approximation to accommodate the expected drop across the low-side MOSFET switch.

The one-shot for the secondary phase varies the on-time in response to the input voltage and the difference between the main and secondary inductor currents. Two identical transconductance amplifiers integrate the difference between the master and slave current-sense signals. The summed output is internally connected to

I<sup>2</sup>R is a registered trademark of instruments for Research and Industry, Inc.



# MAX8770/MAX8771/MAX8772 Dual-Phase, Quick-PWM Controller for IMVP-6+ CPU Core Power Supplies

MAX8770/MAX8771/MAX8772

CCI, allowing adjustment of the integration time constant with a compensation network connected between CCI and FB. The resulting compensation current and voltage are determined by the following equations:

$$I_{CCI} = G_M (V_{CMP} - V_{CMN}) - G_M (V_{CSP} - V_{CSN})$$

$$V_{CCI} = V_{FB} + I_{CCI} Z_{CCI}$$

where  $Z_{CCI}$  is the impedance at the CCI output. The secondary on-time one-shot uses this integrated signal ( $V_{CCI}$ ) to set the secondary high-side MOSFETs on-time. When the main and secondary current-sense signals ( $V_{CM} = V_{CMP} - V_{CMN}$  and  $V_{CS} = V_{CSP} - V_{CSN}$ ) become unbalanced, the transconductance amplifiers adjust the secondary on-time, which increases or decreases the secondary inductor current until the current-sense signals are properly balanced:

$$t_{ON(SEC)} = T_{SW} \left( \frac{V_{CCI} + 0.075V}{V_{IN}} \right)$$

$$= T_{SW} \left( \frac{V_{FB} + 0.075V}{V_{IN}} \right) + T_{SW} \left( \frac{I_{CCI} Z_{CCI}}{V_{IN}} \right)$$

$$= (\text{Main On-Time})$$

$$+ (\text{Secondary Current Balance Correction})$$

This algorithm results in a nearly constant switching frequency and balanced inductor currents, despite the lack of a fixed-frequency clock generator. The benefits of a constant switching frequency are twofold: first, the frequency can be selected to avoid noise-sensitive regions such as the 455kHz IF band; second, the inductor ripple-current operating point remains relatively constant, resulting in easy design methodology and predictable output voltage ripple. The on-time one-shots have good accuracy at the operating points specified in the *Electrical Characteristics* table. On-times at operating points far removed from the conditions specified in the *Electrical Characteristics* table can vary over a wider range. For example, the 600kHz setting typically runs about 5% slower, with inputs much greater than +12V due to the very short on-times required.

On-times translate only roughly to switching frequencies. The on-times guaranteed in the *Electrical Characteristics* table are influenced by switching delays in the external high-side MOSFET. Resistive losses, including the inductor, both MOSFETs, output capacitor ESR, and PC board copper losses in the output and ground tend to raise the switching frequency at higher output currents. Also, the dead-time effect increases the effective on-time, reducing the switching frequency. It occurs only during forced-PWM operation and dynamic output-voltage transitions when the induc-

tor current reverses at light or negative load currents. With reversed inductor current, the inductor's EMF causes LX to go high earlier than normal, extending the on-time by a period equal to the DH-rising dead time. For loads above the critical conduction point, where the dead-time effect is no longer a factor, the actual switching frequency (per phase) is:

$$f_{SW} = \frac{(V_{OUT} + V_{DIS})}{t_{ON}(V_{IN} + V_{DIS} - V_{CHG})}$$

where  $V_{DIS}$  is the sum of the parasitic voltage drops in the inductor discharge path, including synchronous rectifier, inductor, and PC board resistances;  $V_{CHG}$  is the sum of the parasitic voltage drops in the inductor charge path, including high-side switch, inductor, and PC board resistances; and  $t_{ON}$  is the on-time as determined above.

## Current Sense

The output current of each phase is sensed. Low-offset amplifiers are used for current balance, voltage-positioning gain, and current limit. Sensing the current at the output of each phase offers advantages, including less noise sensitivity, more accurate current sharing between phases, and the flexibility of using either a current-sense resistor or the DC resistance of the output inductor.

Using the DC resistance ( $R_{DCR}$ ) of the output inductor allows higher efficiency. In this configuration, the initial tolerance and temperature coefficient of the inductor's DCR must be accounted for in the output-voltage droop-error budget and power monitor. This current-sense method uses an RC filtering network to extract the current information from the output inductor (see Figure 3). The resistive divider used should provide a current-sense resistance ( $R_{CS}$ ) low enough to meet the current-limit requirements, and the time constant of the RC network should match the inductor's time constant ( $L/R_{CS}$ ):

$$R_{CS} = \left( \frac{R_2}{R_1 + R_2} \right) R_{DCR} \quad \text{and}$$

$$R_{CS} = \frac{L}{C_{EQ}} \left[ \frac{1}{R_1} + \frac{1}{R_2} \right]$$

where  $R_{CS}$  is the required current-sense resistance, and  $R_{DCR}$  is the inductor's series DC resistance. Use the worst-case inductance and  $R_{DCR}$  values provided by the inductor manufacturer, adding some margin for the inductance drop over temperature and load. To



# MAX8770/MAX8771/MAX8772 Dual-Phase, Quick-PWM Controller for IMVP-6+ CPU Core Power Supplies

MAX8770/MAX8771/MAX8772

minimize the current-sense error due to the current-sense inputs' bias current ( $I_{CSP\_}$  and  $I_{CSN\_}$ ), choose  $R1||R2$  to be less than  $2k\Omega$  and use the above equation to determine the sense capacitance ( $C_{EQ}$ ). Choose capacitors with 5% tolerance and resistors with 1% tolerance specifications. Temperature compensation is recommended for this current-sense method. See the *Voltage Positioning and the Loop Compensation* section for detailed information.

When using a current-sense resistor for accurate output-voltage positioning, the circuit requires a differential RC filter to eliminate the AC voltage step cause by the equivalent series inductance ( $L_{ESL}$ ) of the current-sense resistor (see Figure 3). The ESL-induced voltage step does not affect the average current-sense voltage,

but results in a significant peak current-sense voltage error that results in unwanted offsets in the regulation voltage and results in early current-limit detection. Similar to the inductor DCR sensing method above, the RC filter's time constant should match the L/R time constant formed by the current-sense resistor's parasitic inductance:

$$\frac{L_{ESL}}{R_{SENSE}} = C_{EQ}R1$$

where  $L_{ESL}$  is the equivalent series inductance of the current-sense resistor,  $R_{SENSE}$  is current-sense resistance value, and  $C_{EQ}$  and  $R_{EQ}$  are the time-constant matching components.

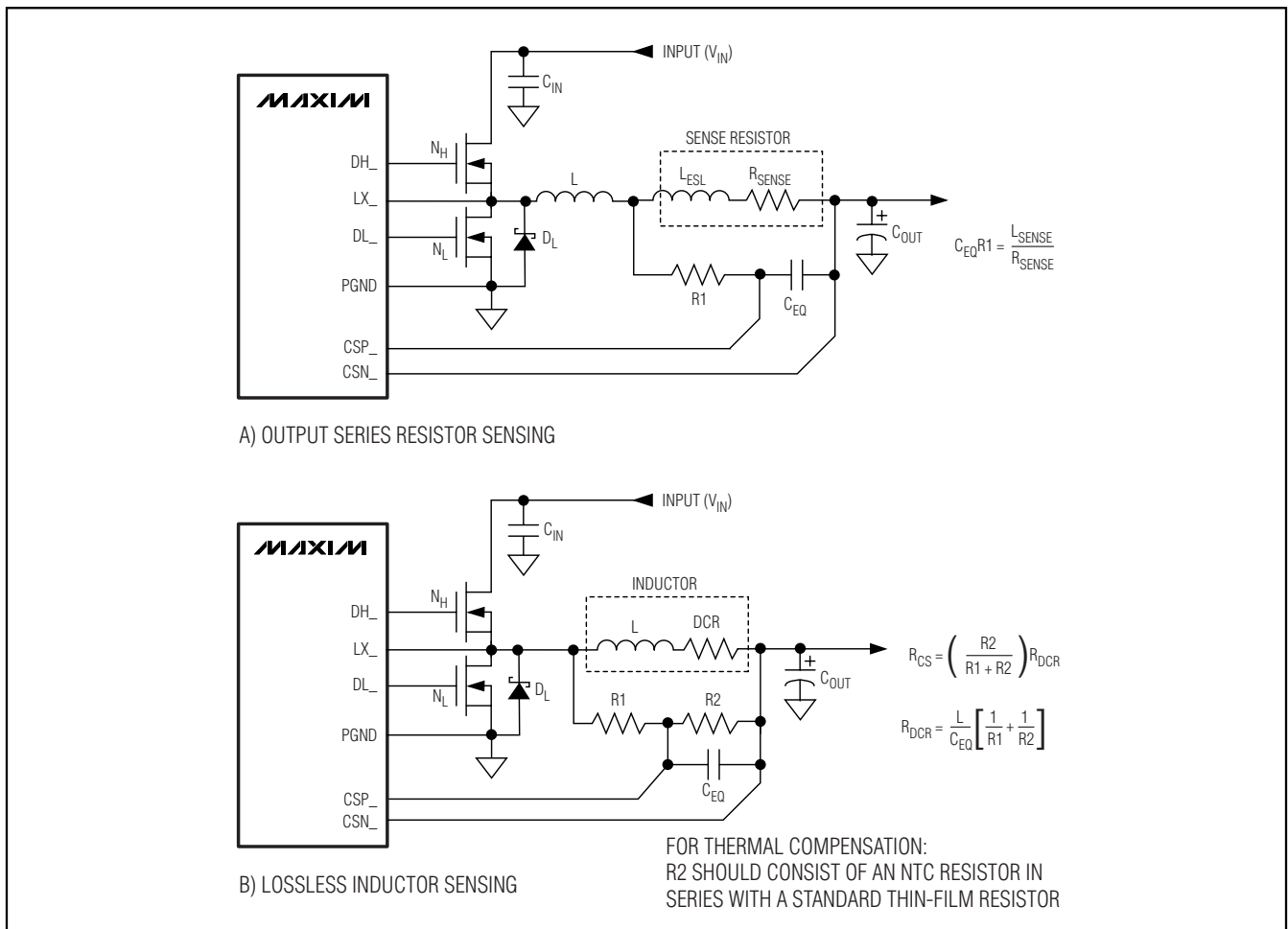

Figure 3. Current-Sense Methods

# MAX8770/MAX8771/MAX8772 Dual-Phase, Quick-PWM Controller for IMVP-6+ CPU Core Power Supplies

## Current Balance

Without active current-balance circuitry, the current matching between phases depends on the MOSFETs' on-resistance ( $R_{DS(ON)}$ ), thermal ballasting, on/off-time matching, and inductance matching. For example, variation in the low-side MOSFET on-resistance (ignoring thermal effects) results in a current mismatch that is proportional to the on-resistance difference:

$$I_{MAIN} - I_{SEC} = I_{MAIN} \left[ 1 - \left( \frac{R_{MAIN}}{R_{SEC}} \right) \right]$$

However, mismatches between on-times, off-times, and inductor values increase the worst-case current imbalance, making it impossible to passively guarantee accurate current balancing.

The MAX8770/MAX8771/MAX8772 integrate the difference between the current-sense voltages and adjust the on-time of the secondary phase to maintain current balance. The current balance now relies on the accuracy of the current-sense resistors instead of the inaccurate, thermally sensitive on-resistance of the low-side MOSFETs. With active current balancing, the current mismatch is determined by the current-sense resistor values and the offset voltage of the transconductance amplifiers:

$$I_{OS(IBAL)} = I_{LMAIN} - I_{LSEC} = \frac{V_{OS(IBAL)}}{R_{SENSE}}$$

where  $R_{SENSE} = R_{CM} = R_{CS}$  and  $V_{OS(IBAL)}$  is the current-balance offset specification in the *Electrical Characteristics* table.

The worst-case current mismatch occurs immediately after a load transient due to inductor value mismatches resulting in different  $di/dt$  for the two phases. The time it takes the current-balance loop to correct the transient imbalance depends on the mismatch between the inductor values and switching frequency.

## Current Limit

The current-limit circuit employs a unique “valley” current-sensing algorithm that uses current-sense resistors between the current-sense inputs (CSP\_ to CSN12 for MAX8771, CSP\_ to CSN\_ for MAX8770/MAX8772) as the current-sensing elements. If the current-sense signal of the selected phase is above the current-limit threshold, the PWM controller does not initiate a new cycle until the inductor current of the selected phase drops below the valley current-limit threshold. When either phase trips the current limit, both phases are effectively current limited since the interleaved controller does not initiate a cycle with either phase.

Since only the valley current is actively limited, the actual peak current is greater than the current-limit threshold by an amount equal to the inductor ripple current. Therefore, the exact current-limit characteristic and maximum load capability are a function of the current-sense resistance, inductor value, and battery voltage. When combined with the UVP circuit, this current-limit method is effective in almost every circumstance.

The positive current-limit threshold is fixed internally at 22.5mV. There is also a negative current limit that prevents excessive reverse inductor currents when  $V_{OUT}$  is sinking current. The negative current-limit threshold is set at -30mV. When a phase drops below the negative current limit, the controller immediately activates an on-time pulse—DL turns off, and DH turns on—allowing the inductor current to remain above the negative current threshold.

Carefully observe the PC board layout guidelines to ensure that noise and DC errors do not corrupt the current-sense signals seen by the current-sense inputs (CSP\_, CSN\_). For the MAX8771, where the negative current-sense returns are to a common pin, it is recommended that the current-sense elements (sense resistor or inductor DCR) be placed close to each other to minimize any voltage differences that might arise due to trace impedance between the two common nodes.

## Feedback Adjustment Amplifiers

### Voltage-Positioning Amplifier (Steady-State Droop)

The MAX8770/MAX8771/MAX8772 include a transconductance amplifier for adding gain to the voltage-positioning sense path. The amplifier's input is generated by summing the current-sense inputs, which differentially sense the voltage across either current-sense resistors or the inductor's DCR. The amplifier's output connects directly to the regulator's voltage-positioned feedback input (FB), so the resistance between FB and the output-voltage sense point determines the voltage-positioning gain:

$$V_{OUT} = V_{TARGET} - R_{FB} I_{FB}$$

where the target voltage ( $V_{TARGET}$ ) is defined in the *Nominal Output Voltage Selection* section, and the FB amplifier's output current ( $I_{FB}$ ) is determined by the sum of the current-sense voltages:

$$I_{FB} = G_{m(FB)} \sum_{X=1}^{\eta_{PH}} V_{CSX}$$

where  $V_{CS} = V_{CSP} - V_{CSN}$  is the differential current-sense voltage, and  $G_{m(FB)}$  is typically 600 $\mu$ S as defined in the *Electrical Characteristics* table.

# MAX8770/MAX8771/MAX8772 Dual-Phase, Quick-PWM Controller for IMVP-6+ CPU Core Power Supplies

MAX8770/MAX8771/MAX8772

### Differential Remote Sense

The MAX8770/MAX8771/MAX8772 include differential, remote-sense inputs to eliminate the effects of voltage drops along the PC board traces and through the processor's power pins. The feedback-sense node connects to the voltage-positioning resistor ( $R_{FB}$ ). The ground-sense (GNDS) input connects to an amplifier that adds an offset directly to the target voltage, effectively adjusting the output voltage to counteract the voltage drop in the ground path. Connect the voltage-positioning resistor ( $R_{FB}$ ), and ground sense (GNDS) input directly to the processor's remote-sense outputs as shown in Figure 1.

### Integrator Amplifier

An integrator amplifier forces the DC average of the FB voltage to equal the target voltage. This transconductance amplifier integrates the feedback voltage and provides a fine adjustment to the regulation voltage (Figure 2), allowing accurate DC output-voltage regulation regardless of the output ripple voltage. The integrator amplifier has the ability to shift the output voltage by  $\pm 60\text{mV}$  (typ), including DC offset and AC ripple. The integration time constant can be set easily with an external compensation capacitor at the CCV pin. Use a  $470\text{pF} \times (2/\eta_{\text{TOTAL}}) \times 300\text{kHz}/f_{\text{SW}}$  or greater ceramic capacitor.

The MAX8770/MAX8771/MAX8772 disable the integrator by connecting the amplifier inputs together at the beginning of all VID transitions done in pulse-skipping mode (DPRSLPVR = high). The integrator remains disabled until  $20\mu\text{s}$  after the transition is completed (the internal target settles) and the output is in regulation (edge detected on the error comparator).

### Transient-Overlap Operation

When a transient occurs, the response time of the controller depends on how quickly it can slew the inductor current. Multiphase controllers that remain  $180^\circ$  out-of-phase when a transient occurs actually respond slower than an equivalent single-phase controller. In order to provide fast transient response, the MAX8770/MAX8771/MAX8772 support a phase-overlap mode that allows the dual regulators to operate in-phase when

heavy load transients are detected, effectively reducing the response time. After either high-side MOSFET turns off, if the output voltage does not exceed the regulation voltage when the minimum off-time expires, the controller simultaneously turns on both high-side MOSFETs during the next on-time cycle. This maximizes the total inductor current slew rate. The phases remain overlapped until the output voltage exceeds the regulation voltage after the minimum off-time expires.

After the phase-overlap mode ends, the controller automatically begins with the opposite phase. For example, if the secondary phase provided the last on-time pulse before overlap operation began, the controller starts switching with the main phase when overlap operation ends.

### Nominal Output-Voltage Selection

The nominal no-load output voltage ( $V_{\text{TARGET}}$ ) is defined by the selected voltage reference (VID DAC) plus the remote ground-sense adjustment ( $V_{\text{GNDS}}$ ), as defined in the following equation:

$$V_{\text{TARGET}} = V_{\text{FB}} = V_{\text{DAC}} + V_{\text{GNDS}}$$

where  $V_{\text{DAC}}$  is the selected VID voltage. On startup, the MAX8770/MAX8771/MAX8772 slew the target voltage from ground to the preset boot voltage.

### DAC Inputs (D0–D6)

The digital-to-analog converter (DAC) programs the output voltage using the D0–D6 inputs. D0–D6 are low-voltage (1.0V) logic inputs, designed to interface directly with the CPU. Do not leave D0–D6 unconnected. Changing D0–D6 initiates a transition to a new output-voltage level. Change D0–D6 together, avoiding greater than 20ns skew between bits. Otherwise, incorrect DAC readings may cause a partial transition to the wrong voltage level followed by the intended transition to the correct voltage level, lengthening the overall transition time. The available DAC codes and resulting output voltages are compatible with the IMVP-6 (Table 4) specifications.

# MAX8770/MAX8771/MAX8772 Dual-Phase, Quick-PWM Controller for IMVP-6+ CPU Core Power Supplies

MAX8770/MAX8771/MAX8772

Table 3. Operating Mode Truth Table

INPUTS				PHASE OPERATION*	OPERATING MODE
SHDN	DPRSTP	DPRSLPVR	PSI		
Low	X	X	X	DISABLED	Low-Power Shutdown Mode. DL1 and DL2 forced high, and the controller is disabled. The supply current drops to 1µA (max).
Rising	X	X	X	Multiphase forced PWM 1/8 RTIME slew rate	Startup/Boot. When SHDN is pulled high, the MAX8770/MAX8771/MAX8772 begin the startup sequence. Once the REF is above 1.84V, the controller enables the PWM controller and ramps the output voltage up to the boot voltage. See Figure 9.
High	X	Low	High	Multiphase forced PWM; normal RTIME slew rate	Full Power. The no-load output voltage is determined by the selected VID DAC code (D0–D6, Table 4).
High	X	Low	Low	1-phase forced PWM; normal RTIME slew rate	Intermediate Power. The no-load output voltage is determined by the selected VID DAC code (D0–D6, Table 4). When PSI is pulled low, the MAX8770/MAX8771/MAX8772 immediately disable phase 2—DH2, and DL2 pulled low.
High	Low	High	X	1-phase pulse skipping, normal RTIME slew rate	Deeper Sleep Mode. The no-load output voltage is determined by the selected VID DAC code (D0–D6, Table 4). When DPRSLPVR is pulled high, the MAX8770/MAX8771/MAX8772 immediately enter 1-phase pulse-skipping operation allowing automatic PWM/PFM switchover under light loads. The PWRGD and CLKEN upper thresholds are blanked. DH2 and DL2 are pulled low.
High	High	High	X	1-phase pulse skipping, 1/4 RTIME slew rate	Deeper Sleep Slow-Exit Mode. The no-load output voltage is determined by the selected VID DAC code (D0–D6, Table 4). When DPRSTP is pulled high while DPRSLPVR is already high, the MAX8770/MAX8771/MAX8772 remain in 1-phase pulse-skipping operation, allowing automatic PWM/PFM switchover under light loads. The PWRGD and CLKEN upper thresholds are blanked. DH2 and DL2 are pulled low.
Falling	X	X	X	Multiphase forced-PWM, 1/8 RTIME slew rate	Shutdown. When SHDN is pulled low, the MAX8770/MAX8771/MAX8772 immediately pull PWRGD and PHASEGD low, CLKEN becomes high impedance, all enabled phases are activated, and the output voltage is ramped down to ground. Once the output reaches zero, the controller enters the low-power shutdown state. See Figure 9.
High	X	X	X	DISABLED	Fault Mode. The fault latch has been set by the MAX8770/MAX8771/MAX8772 UVP or thermal shutdown protection, or by the MAX8771 OVP protection. The controller remains in FAULT mode until VCC power is cycled or SHDN toggled.

\*Multiphase operation = All enabled phases active.

## MAX8770/MAX8771/MAX8772 Dual-Phase, Quick-PWM Controller for IMVP-6+ CPU Core Power Supplies

Table 4. IMVP-6 Output Voltage VID DAC Codes

D6	D5	D4	D3	D2	D1	D0	OUTPUT VOLTAGE (V)	D6	D5	D4	D3	D2	D1	D0	OUTPUT VOLTAGE (V)
0	0	0	0	0	0	0	1.5000	1	0	0	0	0	0	0	0.7000
0	0	0	0	0	0	1	1.4875	1	0	0	0	0	0	1	0.6875
0	0	0	0	0	1	0	1.4750	1	0	0	0	0	1	0	0.6750
0	0	0	0	0	1	1	1.4625	1	0	0	0	0	1	1	0.6625
0	0	0	0	1	0	0	1.4500	1	0	0	0	1	0	0	0.6500
0	0	0	0	1	0	1	1.4375	1	0	0	0	1	0	1	0.6375
0	0	0	0	1	1	0	1.4250	1	0	0	0	1	1	0	0.6250
0	0	0	0	1	1	1	1.4125	1	0	0	0	1	1	1	0.6125
0	0	0	1	0	0	0	1.4000	1	0	0	1	0	0	0	0.6000
0	0	0	1	0	0	1	1.3875	1	0	0	1	0	0	1	0.5875
0	0	0	1	0	1	0	1.3750	1	0	0	1	0	1	0	0.5750
0	0	0	1	0	1	1	1.3625	1	0	0	1	0	1	1	0.5625
0	0	0	1	1	0	0	1.3500	1	0	0	1	1	0	0	0.5500
0	0	0	1	1	0	1	1.3375	1	0	0	1	1	0	1	0.5375
0	0	0	1	1	1	0	1.3250	1	0	0	1	1	1	0	0.5250
0	0	0	1	1	1	1	1.3125	1	0	0	1	1	1	1	0.5125
0	0	1	0	0	0	0	1.3000	1	0	1	0	0	0	0	0.5000
0	0	1	0	0	0	1	1.2875	1	0	1	0	0	0	1	0.4875
0	0	1	0	0	1	0	1.2750	1	0	1	0	0	1	0	0.4750
0	0	1	0	0	1	1	1.2625	1	0	1	0	0	1	1	0.4625
0	0	1	0	1	0	0	1.2500	1	0	1	0	1	0	0	0.4500
0	0	1	0	1	0	1	1.2375	1	0	1	0	1	0	1	0.4375
0	0	1	0	1	1	0	1.2250	1	0	1	0	1	1	0	0.4250
0	0	1	0	1	1	1	1.2125	1	0	1	0	1	1	1	0.4125
0	0	1	1	0	0	0	1.2000	1	0	1	1	0	0	0	0.4000
0	0	1	1	0	0	1	1.1875	1	0	1	1	0	0	1	0.3875
0	0	1	1	0	1	0	1.1750	1	0	1	1	0	1	0	0.3750
0	0	1	1	0	1	1	1.1625	1	0	1	1	0	1	1	0.3625
0	0	1	1	1	0	0	1.1500	1	0	1	1	1	0	0	0.3500
0	0	1	1	1	0	1	1.1375	1	0	1	1	1	0	1	0.3375
0	0	1	1	1	1	0	1.1250	1	0	1	1	1	1	0	0.3250
0	0	1	1	1	1	1	1.1125	1	0	1	1	1	1	1	0.3125

MAX8770/MAX8771/MAX8772

## MAX8770/MAX8771/MAX8772 Dual-Phase, Quick-PWM Controller for IMVP-6+ CPU Core Power Supplies

MAX8770/MAX8771/MAX8772

Table 4. IMVP-6 Output Voltage VID DAC Codes (continued)

D6	D5	D4	D3	D2	D1	D0	OUTPUT VOLTAGE (V)	D6	D5	D4	D3	D2	D1	D0	OUTPUT VOLTAGE (V)
0	1	0	0	0	0	0	1.1000	1	1	0	0	0	0	0	0.3000
0	1	0	0	0	0	1	1.0875	1	1	0	0	0	0	1	0.2875
0	1	0	0	0	1	0	1.0750	1	1	0	0	0	1	0	0.2750
0	1	0	0	0	1	1	1.0625	1	1	0	0	0	1	1	0.2625
0	1	0	0	1	0	0	1.0500	1	1	0	0	1	0	0	0.2500
0	1	0	0	1	0	1	1.0375	1	1	0	0	1	0	1	0.2375
0	1	0	0	1	1	0	1.0250	1	1	0	0	1	1	0	0.2250
0	1	0	0	1	1	1	1.0125	1	1	0	0	1	1	1	0.2125
0	1	0	1	0	0	0	1.0000	1	1	0	1	0	0	0	0.2000
0	1	0	1	0	0	1	0.9875	1	1	0	1	0	0	1	0.1875
0	1	0	1	0	1	0	0.9750	1	1	0	1	0	1	0	0.1750
0	1	0	1	0	1	1	0.9625	1	1	0	1	0	1	1	0.1625
0	1	0	1	1	0	0	0.9500	1	1	0	1	1	0	0	0.1500
0	1	0	1	1	0	1	0.9375	1	1	0	1	1	0	1	0.1375
0	1	0	1	1	1	0	0.9250	1	1	0	1	1	1	0	0.1250
0	1	0	1	1	1	1	0.9125	1	1	0	1	1	1	1	0.1125
0	1	1	0	0	0	0	0.9000	1	1	1	0	0	0	0	0.1000
0	1	1	0	0	0	1	0.8875	1	1	1	0	0	0	1	0.0875
0	1	1	0	0	1	0	0.8750	1	1	1	0	0	1	0	0.0750
0	1	1	0	0	1	1	0.8625	1	1	1	0	0	1	1	0.0625
0	1	1	0	1	0	0	0.8500	1	1	1	0	1	0	0	0.0500
0	1	1	0	1	0	1	0.8375	1	1	1	0	1	0	1	0.0375
0	1	1	0	1	1	0	0.8250	1	1	1	0	1	1	0	0.0250
0	1	1	0	1	1	1	0.8125	1	1	1	0	1	1	1	0.0125
0	1	1	1	0	0	0	0.8000	1	1	1	1	0	0	0	0
0	1	1	1	0	0	1	0.7875	1	1	1	1	0	0	1	0
0	1	1	1	0	1	0	0.7750	1	1	1	1	0	1	0	0
0	1	1	1	0	1	1	0.7625	1	1	1	1	0	1	1	0
0	1	1	1	1	0	0	0.7500	1	1	1	1	1	0	0	0
0	1	1	1	1	0	1	0.7375	1	1	1	1	1	0	1	0
0	1	1	1	1	1	0	0.7250	1	1	1	1	1	1	0	0
0	1	1	1	1	1	1	0.7125	1	1	1	1	1	1	1	0



# MAX8770/MAX8771/MAX8772 Dual-Phase, Quick-PWM Controller for IMVP-6+ CPU Core Power Supplies

## Suspend Mode

When the processor enters low-power deeper sleep mode, the IMVP-6 CPU sets the VID DAC code to a lower output voltage and drives DPRSLPVR high. The MAX8770/MAX8771/MAX8772 respond by slewing the internal target voltage to the new DAC code, switching to single-phase operation, and letting the output voltage gradually drift down to the deeper sleep voltage. During the transition, the MAX8770/MAX8771/MAX8772 blank both the upper and lower PWRGD and CLKEN thresholds until 20μs after the internal target reaches the deeper sleep voltage. Once the 20μs timer expires, the MAX8770/MAX8771/MAX8772 reenables the lower PWRGD and CLKEN threshold, but keep the upper threshold blanked. PHASEGD remains blanked high impedance while DPRSLPVR is high.

## Output-Voltage Transition Timing

The MAX8770/MAX8771/MAX8772 perform mode transitions in a controlled manner, automatically minimizing input surge currents. This feature allows the circuit designer to achieve nearly ideal transitions, guaranteeing just-in-time arrival at the new output-voltage level with the lowest possible peak currents for a given output capacitance.

At the beginning of an output-voltage transition, the MAX8770/MAX8771/MAX8772 blank PHASEGD, CLKEN, and PWRGD upper and lower thresholds, preventing the open-drain outputs from changing states during the transition. The controller enables the lower CLKEN and PWRGD threshold approximately 20μs after the slew-rate controller reaches the target output voltage, but the upper CLKEN and PWRGD threshold is enabled only if the controller remains in forced-PWM operation. If the controller enters pulse-skipping operation, the upper CLKEN and PWRGD threshold remains blanked. The slew rate (set by resistor R<sub>TIME</sub>) must be set fast enough to ensure that the transition may be completed within the maximum allotted time.

The MAX8770/MAX8771/MAX8772 automatically control the current to the minimum level required to complete the transition in the calculated time. The slew-rate controller uses an internal capacitor and current source programmed by R<sub>TIME</sub> to transition the output voltage. The total transition time depends on R<sub>TIME</sub>, the voltage difference, and the accuracy of the slew-rate controller (CSLEW accuracy). The slew rate is not dependent on the total output capacitance, as long as the surge current is less than the current limit. For all dynamic VID

transitions, the transition time (t<sub>TRAN</sub>) is given by:

$$t_{\text{TRAN}} = \frac{|V_{\text{NEW}} - V_{\text{OLD}}|}{(dV_{\text{TARGET}}/dt)}$$

where  $dV_{\text{TARGET}}/dt = 12.5\text{mV}/\mu\text{s} \times 71.5\text{k}\Omega / R_{\text{TIME}}$  is the slew rate,  $V_{\text{OLD}}$  is the original output voltage, and  $V_{\text{NEW}}$  is the new target voltage. See TIME Slew Rate Accuracy in *Electrical Characteristics* for slew-rate limits. For soft-start and shutdown, the controller automatically reduces the slew rate to 1/8.

The output voltage tracks the slewed target voltage, making the transitions relatively smooth. The average inductor current per phase required to make an output voltage transition is:

$$I_L \cong \frac{C_{\text{OUT}}}{\eta_{\text{TOTAL}}} \times (dV_{\text{TARGET}}/dt)$$

where  $dV_{\text{TARGET}}/dt$  is the required slew rate,  $C_{\text{OUT}}$  is the total output capacitance, and  $\eta_{\text{TOTAL}}$  is the number of active phases.

## Deeper Sleep Transitions

When DPRSLPVR goes high, the MAX8770/MAX8771/MAX8772 immediately disable phase 2 (DH2 and DL2 forced low), blank PHASEGD high impedance (MAX8771 only), and enter pulse-skipping operation (see Figures 4 and 5). If the VIDs are set to a lower voltage setting, the output drops at a rate determined by the load and the output capacitance. The internal target still ramps as before, and CLKEN and PWRGD upper and lower thresholds remain blanked until 20μs after the internal target reaches the programmed VID code. Once this time expires, PWRGD monitors only the lower threshold:

- **Fast C4E Deeper Sleep Exit:** When exiting deeper sleep (DPRSLPVR pulled low) while the output voltage still exceeds the deeper sleep voltage, the MAX8770/MAX8771/MAX8772 quickly slew (50mV/μs min regardless of R<sub>TIME</sub> setting) the internal target voltage to the DAC code provided by the processor as long as the output voltage is above the new target. The controller remains in skip mode until the output voltage equals the internal target. Once the internal target reaches the output voltage, phase 2 is enabled. The controller blanks PWRGD, PHASEGD, and CLKEN (forced high impedance) until 20μs after the transition is completed. See Figure 4.



# MAX8770/MAX8771/MAX8772 Dual-Phase, Quick-PWM Controller for IMVP-6+ CPU Core Power Supplies

MAX8770/MAX8771/MAX8772

- Standard C4 Deeper Sleep Exit:** When exiting deeper sleep (DPRSLPVR pulled low) while the output voltage is regulating to the deeper sleep voltage, the MAX8770/MAX8771/MAX8772 immediately activate all enabled phases and ramp the output voltage to the LFM DAC code provided by the processor at the slew rate set by  $R_{TIME}$ . The controller blanks PWRGD, PHASEGD, and  $\overline{CLKEN}$  (forced high impedance) until  $20\mu s$  after the transition is completed. See Figure 5.
- Slow C4 Deeper Sleep Exit:** When exiting deeper sleep (DPRSLPVR high,  $\overline{DPRSTP}$  pulled high) while the output voltage is regulating to the deeper sleep voltage, the MAX8770/MAX8771/MAX8772 remain in 1-phase skip mode and ramp the output voltage to the LFM DAC code provided by the processor at  $1/4$  the slew-rate set by  $R_{TIME}$ . The controller blanks PWRGD, PHASEGD, and  $\overline{CLKEN}$  (forced high impedance) until  $20\mu s$  after the transition is completed. See Figure 6.

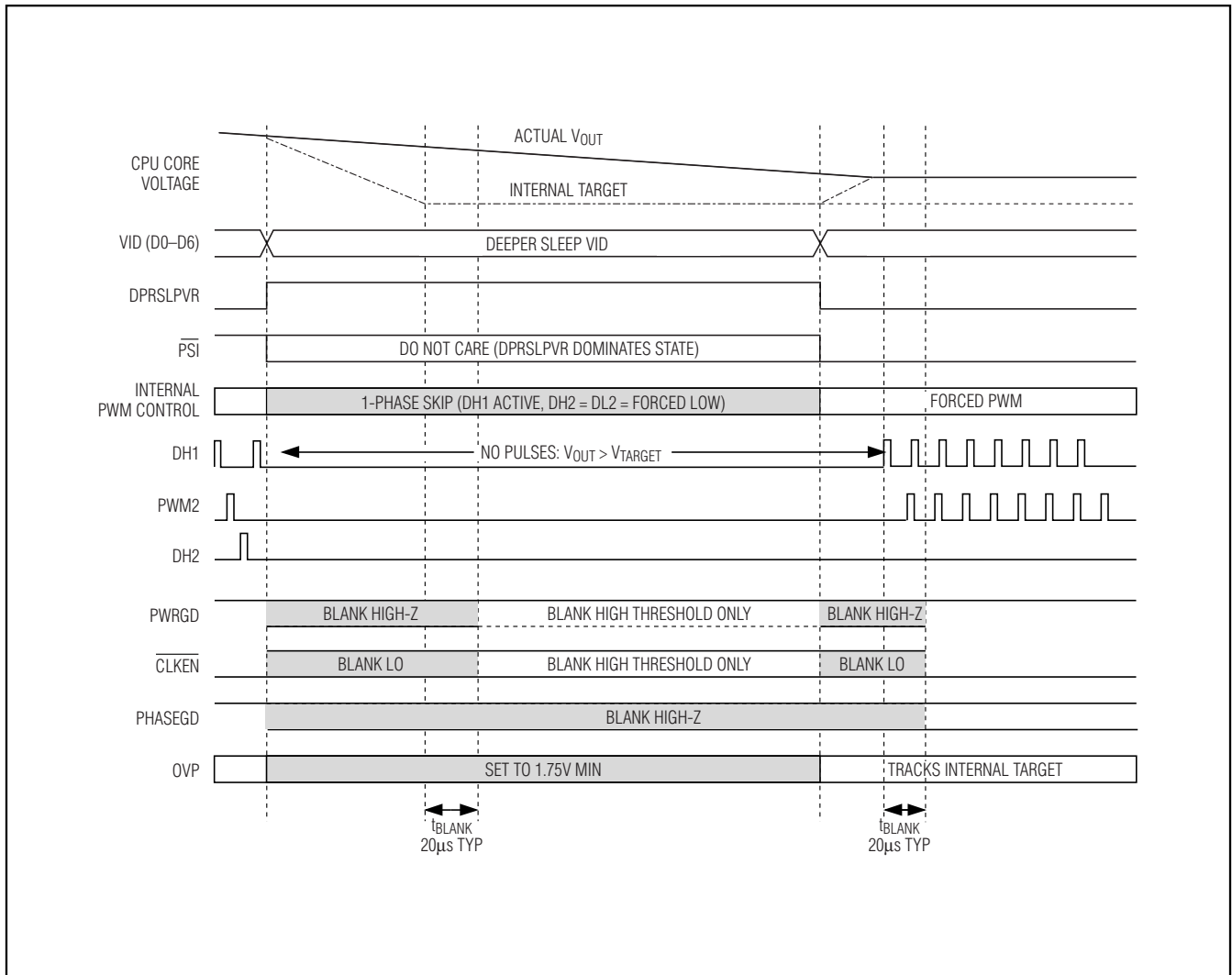

Figure 4. C4E (C4 Early Exit) Transition

# MAX8770/MAX8771/MAX8772 Dual-Phase, Quick-PWM Controller for IMVP-6+ CPU Core Power Supplies

MAX8770/MAX8771/MAX8772

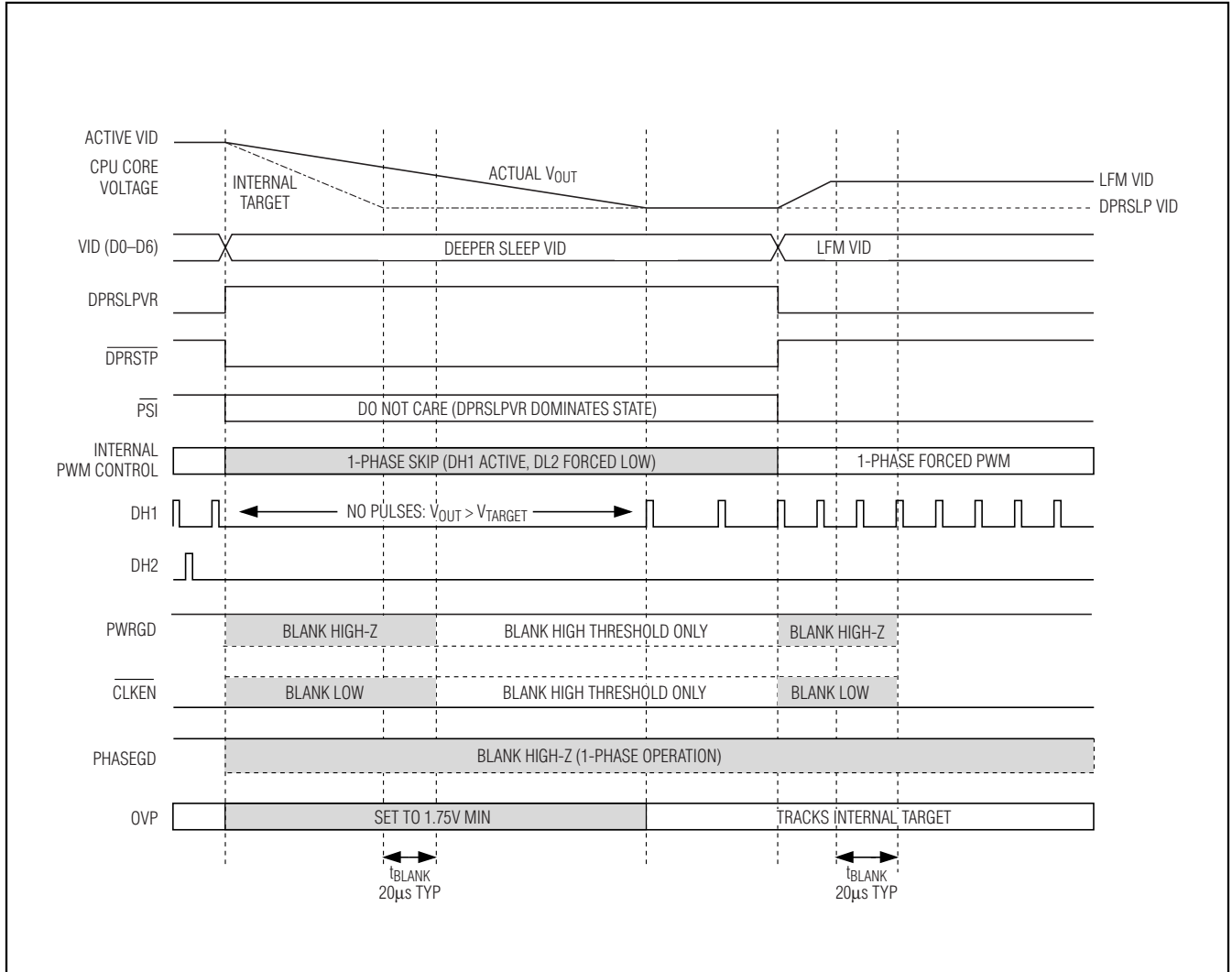

Figure 5. Standard C4 Transition

# MAX8770/MAX8771/MAX8772 Dual-Phase, Quick-PWM Controller for IMVP-6+ CPU Core Power Supplies

MAX8770/MAX8771/MAX8772

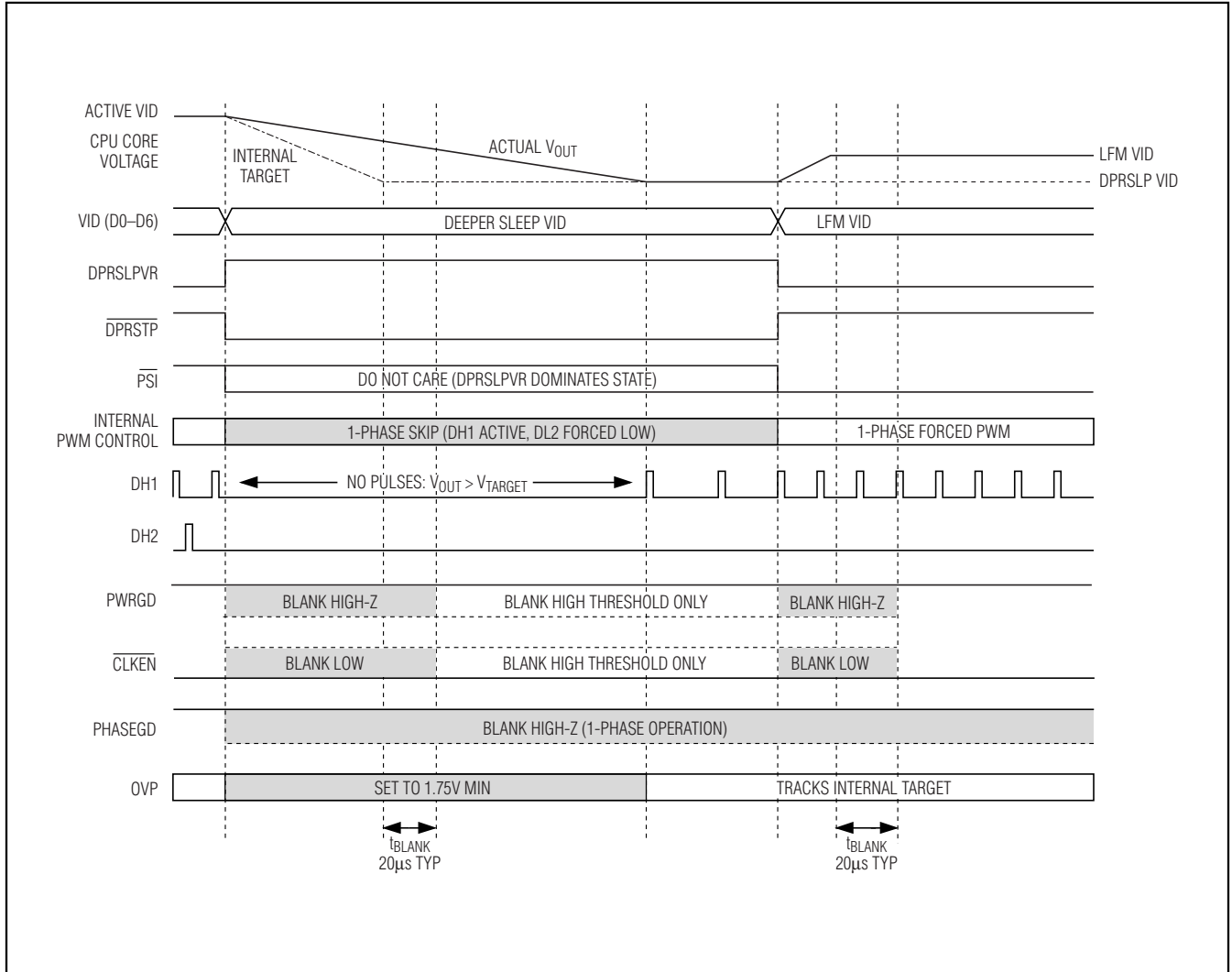

Figure 6. Slow C4 Transition

# MAX8770/MAX8771/MAX8772 Dual-Phase, Quick-PWM Controller for IMVP-6+ CPU Core Power Supplies

## PSI Transitions

When  $\overline{\text{PSI}}$  is pulled low, the MAX8770/MAX8771/MAX8772 immediately disable phase 2 (DH2 and DL2 forced low), blank PHASEGD high impedance, and enter single-phase PWM operation (see Figure 7). When  $\overline{\text{PSI}}$  is pulled high, the MAX8770/MAX8771/MAX8772 enable

phase 2. PHASEGD is blanked high impedance for 32 switching cycles on DH2, allowing sufficient time/cycles for phase 1 and 2 to achieve current balance. In a typical IMVP-6 application, the VID is reduced by 1 LSB (12.5mV) when  $\overline{\text{PSI}}$  is pulled low, and increased by 1 LSB when  $\overline{\text{PSI}}$  is pulled high.

MAX8770/MAX8771/MAX8772

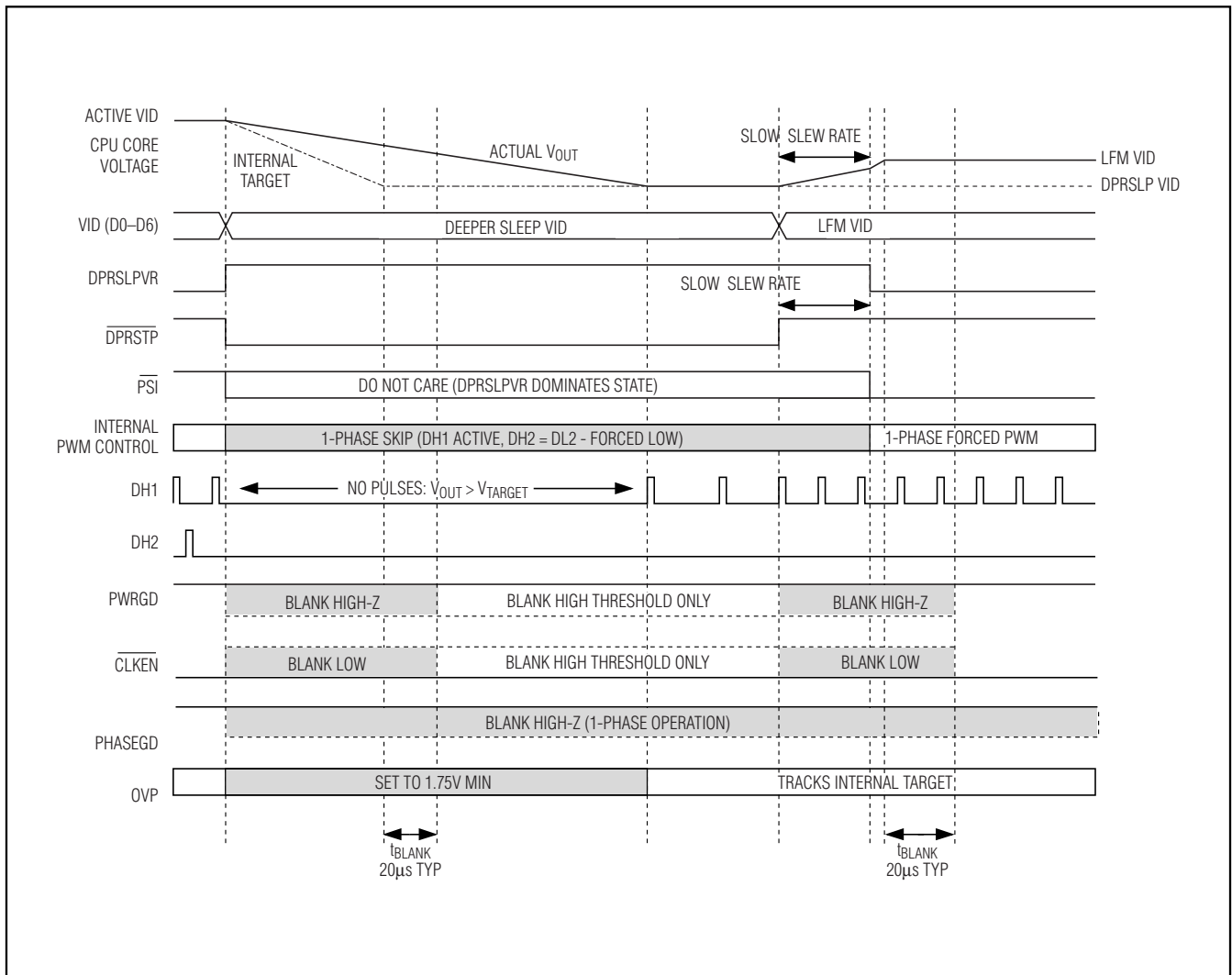

Figure 7.  $\overline{\text{PSI}}$  Transition

# MAX8770/MAX8771/MAX8772 Dual-Phase, Quick-PWM Controller for IMVP-6+ CPU Core Power Supplies

MAX8770/MAX8771/MAX8772

## Forced-PWM Operation (Normal Mode)

During soft-start, soft-shutdown, and normal operation—when the CPU is actively running (DPRSLPVR = low, Table 5)—the MAX8770/MAX8771/MAX8772 operate with the low-noise, forced-PWM control scheme. Forced-PWM operation disables the zero-crossing comparators of all active phases, forcing the low-side gate-drive waveforms to be constantly the complement of the high-side gate-drive waveforms. This keeps the switching frequency constant and allows the inductor current to reverse under light loads, providing fast, accurate negative-output-voltage transitions by quickly discharging the output capacitors.

Forced-PWM operation comes at a cost; the no-load +5V bias supply current remains between 10mA to 50mA per phase, depending on the external MOSFETs and switching frequency. To maintain high efficiency under light-load conditions, the processor may switch the controller to a low-power, pulse-skipping control scheme after entering suspend mode.

$\overline{\text{PSI}}$  determines how many phases are active when operating in forced-PWM mode (DPRSLPVR = low). When  $\overline{\text{PSI}}$  is pulled low, the main phase remains active but the secondary phase is disabled (DH2 and DL2 forced low).

## Light-Load Pulse-Skipping Operation (Deeper Sleep)

When DPRSLPVR is pulled high, the MAX8770/MAX8771/MAX8772 operate with a single-phase, pulse-skipping mode. The pulse-skipping mode enables the driver's zero-crossing comparator, so the controller pulls DL1 low when its current-sense inputs detect "zero" inductor current. This keeps the inductor from discharging the output capacitors and forces the controller to skip pulses under light-load conditions to avoid overcharging the output.

When pulse skipping, the controller blanks the upper PWRGD and  $\overline{\text{CLKEN}}$  thresholds, and also blanks PHASEGD high impedance for the MAX8771. Upon entering pulse-skipping operation, the controller temporarily sets the OVP threshold to 1.80V, preventing false OVP faults when the transition to pulse-skipping operation coincides with a downward VID code change. Once the error amplifier detects that the output voltage is in regulation, the OVP threshold tracks the selected VID DAC code. The MAX8770/MAX8771/MAX8772 automatically use forced-PWM operation during soft-start and soft-shutdown, regardless of the DPRSLPVR and  $\overline{\text{PSI}}$  configuration.

## Automatic Pulse-Skipping Switchover

In skip mode (DPRSLPVR = high), an inherent automatic switchover to PFM takes place at light loads (Figure 8). This switchover is affected by a comparator that truncates the low-side switch on-time at the inductor current's zero crossing. The zero-crossing comparator senses the inductor current across the low-side MOSFETs. Once  $V_{LX}$  drops below the zero crossing comparator threshold (see the *Electrical Characteristics* table), the comparator forces DL low (Figure 2). This mechanism causes the threshold between pulse-skipping PFM and nonskipping PWM operation to coincide with the boundary between continuous and discontinuous inductor-current operation. The PFM/PWM crossover occurs when the load current of each phase is equal to 1/2 the peak-to-peak ripple current, which is a function of the inductor value (Figure 8). For a battery-input 7V to 20V range, this threshold is relatively constant, with only a minor dependence on the input voltage due to the typically low duty cycles. The total load current at the PFM/PWM crossover threshold ( $I_{\text{LOAD(SKIP)}}$ ) is approximately:

$$I_{\text{LOAD(SKIP)}} = \eta_{\text{TOTAL}} \left( \frac{T_{\text{SW}} V_{\text{OUT}}}{L} \right) \left( \frac{V_{\text{IN}} - V_{\text{OUT}}}{V_{\text{IN}}} \right)$$

where  $\eta_{\text{TOTAL}}$  is the number of active phases.

The switching waveforms may appear noisy and asynchronous when light loading activates pulse-skipping operation, but this is a normal operating condition that results in high light-load efficiency. Trade-offs between PFM noise and light-load efficiency are made by vary-

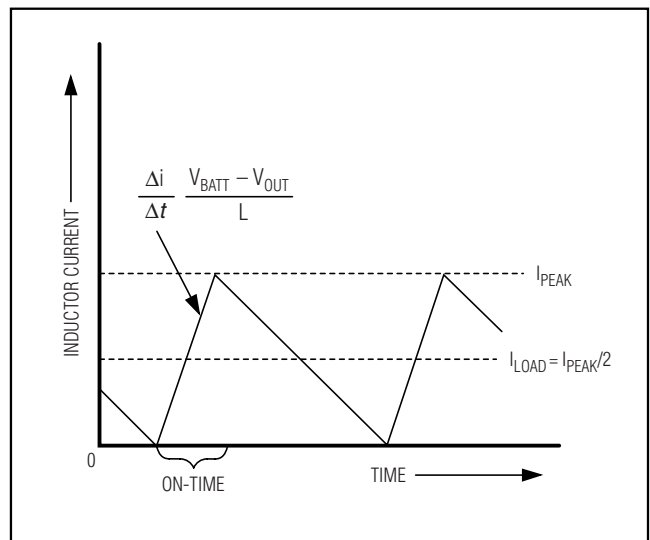

Figure 8. Pulse-Skipping/Discontinuous Crossover Point

# MAX8770/MAX8771/MAX8772 Dual-Phase, Quick-PWM Controller for IMVP-6+ CPU Core Power Supplies

ing the inductor value. Generally, low inductor values produce a broader efficiency vs. load curve, while higher values result in higher full-load efficiency (assuming that the coil resistance remains fixed) and less output-voltage ripple. Penalties for using higher inductor values include larger physical size and degraded load-transient response, especially at low input-voltage levels.

### Power-Up Sequence (POR, UVLO)

The MAX8770/MAX8771/MAX8772 are enabled when SHDN is driven high (Figure 9). The reference powers up first. Once the reference exceeds its UVLO threshold, the internal analog blocks are turned on and masked by a 150µs one-shot delay. The PWM controller then begins switching.

Power-on reset (POR) occurs when VCC rises above approximately 2V, resetting the fault latch and preparing the controller for operation. The VCC UVLO circuitry

MAX8770/MAX8771/MAX8772

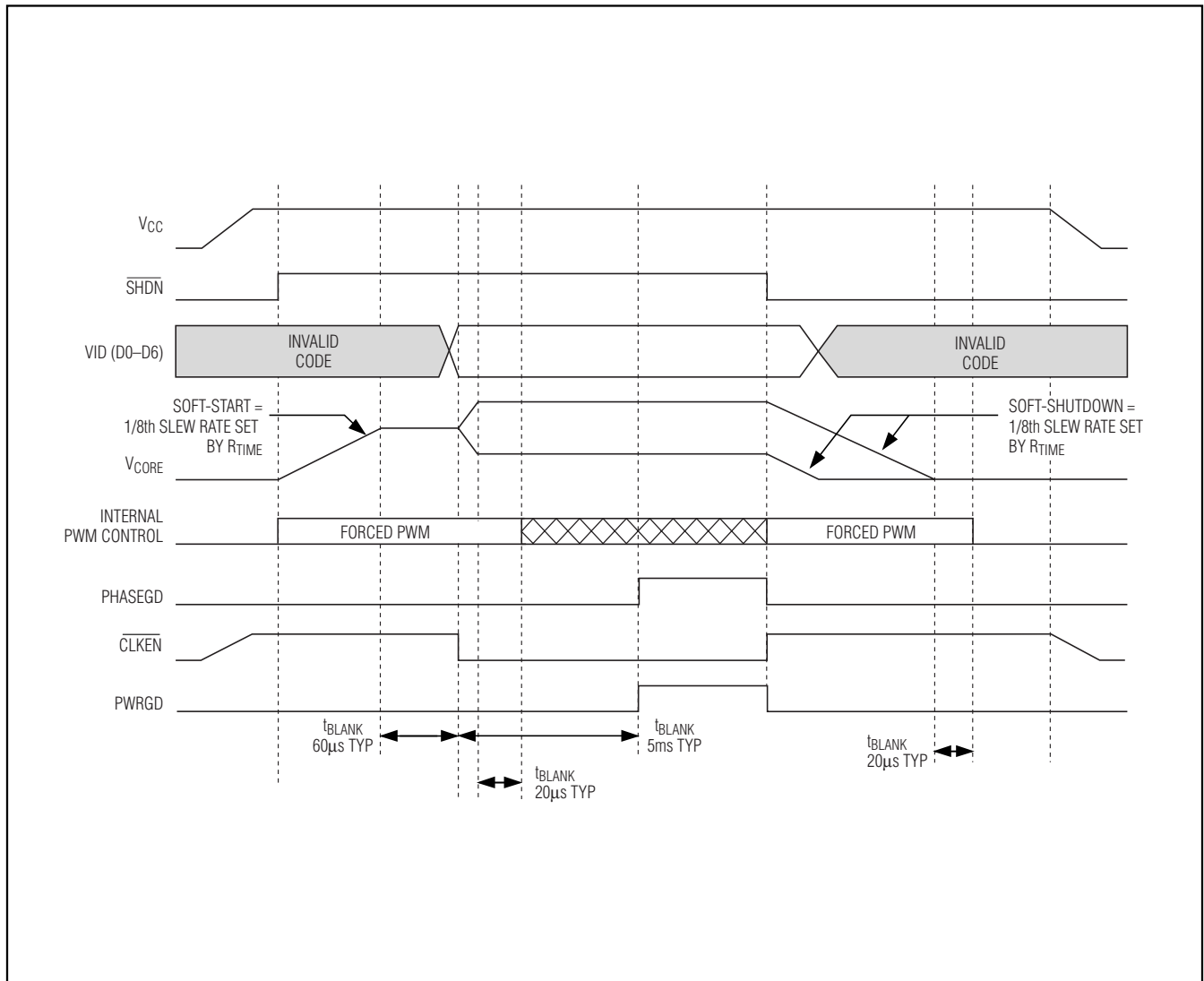

Figure 9. Power-Up and Shutdown Sequence Timing Diagram

# MAX8770/MAX8771/MAX8772 Dual-Phase, Quick-PWM Controller for IMVP-6+ CPU Core Power Supplies

MAX8770/MAX8771/MAX8772

inhibits switching until  $V_{CC}$  rises above 4.25V. The controller powers up the reference once the system enables the controller,  $V_{CC}$  above 4.25V and  $\overline{SHDN}$  driven high. With the reference in regulation, the controller ramps the output voltage to the 1.20V boot voltage at 1/8 the slew rate set by  $R_{TIME}$ :

$$t_{TRAN(START)} = \frac{8V_{BOOT}}{(dV_{TARGET}/dt)}$$

where  $dV_{TARGET}/dt = 12.5mV/\mu s \times 71.5k\Omega / R_{TIME}$  is the slew rate. The soft-start circuitry does not use a variable current limit, so full output current is available immediately.  $\overline{CLKEN}$  is pulled low approximately 60 $\mu s$  after the MAX8770/MAX8771/MAX8772 reach the boot voltage. At the same time, the MAX8770/MAX8771/MAX8772 slew the output to the voltage set at the VID inputs at the programmed slew rate.  $PWRGD$  and  $PHASEGD$  become high impedance approximately 5ms after  $\overline{CLKEN}$  is pulled low. The MAX8770/MAX8771/MAX8772 automatically use forced-PWM operation during soft-start and soft-shutdown, regardless of the  $DPRSLPVR$  and  $\overline{PSI}$  configuration.

For automatic startup, the battery voltage should be present before  $V_{CC}$ . If the controller attempts to bring the output into regulation without the battery-voltage present, the fault latch trips. The controller remains shut down until the fault latch is cleared by toggling  $\overline{SHDN}$  or cycling the  $V_{CC}$  power supply below 0.5V.

If the  $V_{CC}$  voltage drops below 4.25V, the controller assumes that there is not enough supply voltage to make valid decisions. To protect the output from over-voltage faults, the controller shuts down immediately and forces a high-impedance output.

### Shutdown

When  $\overline{SHDN}$  goes low, the MAX8770/MAX8771/MAX8772 enter low-power shutdown mode.  $\overline{CLKEN}$  is pulled high and  $PWRGD$  is pulled low immediately, and the output voltage ramps down at 1/8 the slew rate set by  $R_{TIME}$ :

$$t_{TRAN(SHDN)} = \frac{8V_{OUT}}{(dV_{TARGET}/dt)}$$

where  $dV_{TARGET}/dt = 12.5mV/\mu s \times 71.5k\Omega / R_{TIME}$  is the slew rate. Slowly discharging the output capacitors by slewing the output over a long period of time keeps the average negative inductor current low (damped response), thereby eliminating the negative output-voltage excursion that occurs when the controller discharges the output quickly by permanently turning on the low-side MOSFET (underdamped response). This

eliminates the need for the Schottky diode normally connected between the output and ground to clamp the negative output-voltage excursion. After the controller reaches the zero target, the MAX8770/MAX8771/MAX8772 shut down completely—the drivers are disabled ( $DL1$  and  $DL2$  driven high)—the reference turns off, and the supply currents drop to about 1 $\mu A$  (max) 20 $\mu s$ .

When a fault condition—output UVLO or thermal shutdown—activates the shutdown sequence, the protection circuitry sets the fault latch to prevent the controller from restarting. To clear the fault latch and reactivate the controller, toggle  $\overline{SHDN}$  or cycle  $V_{CC}$  power below 0.5V.

### Power Monitor (POUT)

The MAX8770/MAX8771/MAX8772 include a single-quadrant multiplier used to determine the actual output power based on the inductor current (sum of the differential CS inputs) and output voltage ( $CSN_{pm}$  to  $GNDS$ , when  $CSN_{pm} = CSN12$  for MAX8771,  $CSN_{pm} = CSN2$  for MAX8770/MAX8772). The buffered output of this multiplier is connected to  $POUT$  and provides a voltage relative to the output power dissipation:

$$V_{PWR} = \frac{(V_{CSN_{pm}} - V_{GNDS})(I_{LOAD}R_{SENSE})}{K_{PWR}}$$

where the power-monitor scale factor ( $K_{PWR}$ ) is typically 16.67mV. The power monitor allows the system to accurately monitor the CPU's power dissipation and quickly predict if the system is about to overheat before the significantly slower temperature sensor signals an overtemperature alert.

### Phase Fault (PHASEGD, MAX8771 Only)

The MAX8771 includes a phase-fault output that signals the system that one of the two phases either has a fault condition or is not matched with the other. Detection is done by identifying the need for a large on-time difference between phases in order to achieve or move towards current balance.  $PHASEGD$  is forced low when  $V_{CCI}$  is below  $0.6 \times V_{FB}$  or above  $1.4 \times V_{FB}$ .

$PHASEGD$  is high impedance when the MAX8771 is set to run in 1-phase operation ( $DPRSLPVR$  high, or  $\overline{PSI}$  low and  $DPRSLPVR$  low). On exit to the 2-phase mode,  $PHASEGD$  is forced high impedance for 32 switching cycles on  $DH2$ .

$PHASEGD$  is low in shutdown.  $PHASEGD$  is forced high impedance whenever the slew rate controller is active (output voltage transitions).



# MAX8770/MAX8771/MAX8772 Dual-Phase, Quick-PWM Controller for IMVP-6+ CPU Core Power Supplies

## Temperature Comparator ( $\overline{VRHOT}$ )

The MAX8770/MAX8771/MAX8772 also feature an independent comparator with an accurate threshold ( $V_{HOT}$ ) that tracks the analog supply voltage ( $V_{HOT} = 0.3V_{CC}$ ). This makes the thermal trip threshold independent of the  $V_{CC}$  supply voltage tolerance. Use a resistor- and thermistor-divider between  $V_{CC}$  and GND to generate a voltage-regulator overtemperature monitor. Place the thermistor as close to the MOSFETs and inductors as possible.

## Fault Protection (Latched)

### Output Overvoltage Protection (MAX8770/MAX8771 Only)

The OVP circuit is designed to protect the CPU against a shorted high-side MOSFET by drawing high current and blowing the battery fuse. The MAX8770/MAX8771 continuously monitor the output for an overvoltage fault. The controller detects an OVP fault if the output voltage exceeds the set VID DAC voltage by more than 300mV, regardless of the operating state. During pulse-skipping operation (DPRSLPVR = high), the OVP threshold is set at 1.8V once a downward VID transition occurs, and reverts to track the VID DAC voltage when the output reaches the set VID code.

When the OVP circuit detects an overvoltage fault while in multiphase mode (DPRSLPVR = low,  $\overline{PSI}$  = high), the MAX8770/MAX8771 immediately force DL1 and DL2 high and pull DH1 and DH2 low. This action turns on the synchronous-rectifier MOSFETs with 100% duty and, in turn, rapidly discharges the output filter capacitor and forces the output low. If the condition that caused the overvoltage (such as a shorted high-side MOSFET) persists, the battery fuse blows. Toggle  $\overline{SHDN}$  or cycle the  $V_{CC}$  power supply below 0.5V to clear the fault latch and reactivate the controller.

When an overvoltage fault occurs while in 1-phase operation (DPRSLPVR = high, or  $\overline{PSI}$  = low), the MAX8770/MAX8771 immediately force DL1 high and pull DH1 low. DL2 and DH2 remain low as phase 2 was disabled. DL2 is forced high only when the output falls below the UV threshold. Overvoltage protection can be disabled through the no-fault test mode (see the *No-Fault Test Mode* section).

### Output Undervoltage Protection

The output UVP function is similar to foldback current limiting, but employs a timer rather than a variable current limit. If the MAX8770/MAX8771/MAX8772 output voltage is 400mV below the target voltage, the controller activates the shutdown sequence and sets the fault latch. Once the controller ramps down to zero, it

forces the DL1 and DL2 high and pulls DH1 and DH2 low. Toggle  $\overline{SHDN}$  or cycle the  $V_{CC}$  power supply below 0.5V to clear the fault latch and reactivate the controller.

UVP can be disabled through the no-fault test mode (see the *No-Fault Test Mode* section).

### Thermal-Fault Protection

The MAX8770/MAX8771/MAX8772 feature a thermal-fault-protection circuit. When the junction temperature rises above +160°C, a thermal sensor sets the fault latch and activates the soft-shutdown sequence. Once the controller ramps down to zero, it forces the DL1 and DL2 high and pulls DH1 and DH2 low. Toggle  $\overline{SHDN}$  or cycle the  $V_{CC}$  power supply below 0.5V to clear the fault latch and reactivate the controller after the junction temperature cools by 15°C.

Thermal shutdown can be disabled through the no-fault test mode (see the *No-Fault Test Mode* section).

### No-Fault Test Mode

The latched fault-protection features can complicate the process of debugging prototype breadboards since there are (at most) a few milliseconds in which to determine what went wrong. Therefore, a “no-fault” test mode is provided to disable the fault protection—overvoltage protection, undervoltage protection, and thermal shutdown. Additionally, the test mode clears the fault latch if it has been set. The no-fault test mode is entered by forcing 11V to 13V on  $\overline{SHDN}$ .

### MOSFET Gate Drivers

The DH and DL drivers are optimized for driving moderate-sized high-side and larger low-side power MOSFETs. This is consistent with the low duty factor seen in notebook applications where a large  $V_{IN} - V_{OUT}$  differential exists. The high-side gate drivers (DH) source and sink 2.2A, and the low-side gate drivers (DL) source 2.7A and sink 8A. This ensures robust gate drive for high-current applications. The DH\_ floating high-side MOSFET drivers are powered by internal boost switch charge pumps at  $BST_+$ , while the DL\_ synchronous-rectifier drivers are powered directly by the 5V bias supply ( $V_{DD}$ ).

Adaptive dead-time circuits monitor the DL and DH drivers and prevent either FET from turning on until the other is fully off. The adaptive driver dead time allows operation without shoot-through with a wide range of MOSFETs, minimizing delays and maintaining efficiency.

There must be a low-resistance, low-inductance path from the DL and DH drivers to the MOSFET gates for the adaptive dead-time circuits to work properly; otherwise, the sense circuitry in the MAX8770/

# MAX8770/MAX8771/MAX8772 Dual-Phase, Quick-PWM Controller for IMVP-6+ CPU Core Power Supplies

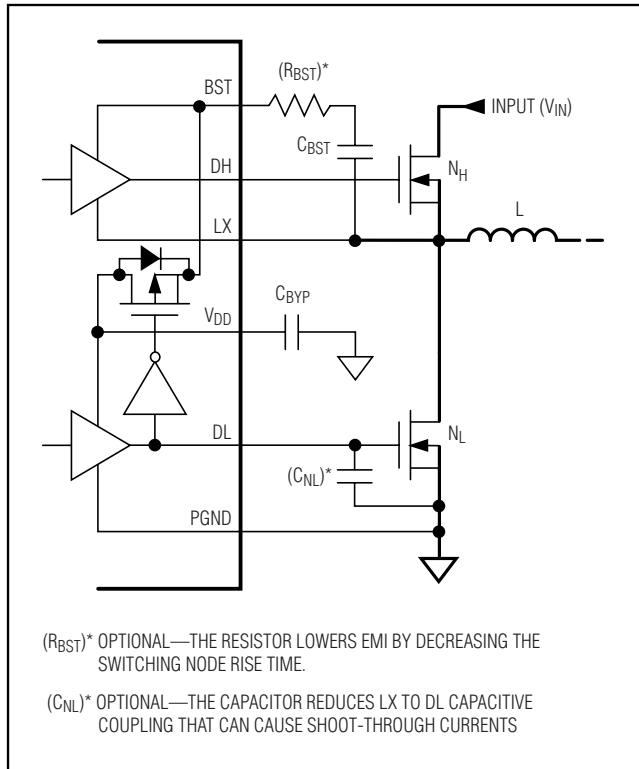

Figure 10. Gate Drive Circuit

MAX8771/MAX8772 interprets the MOSFET gates as “off” while charge actually remains. Use very short, wide traces (50 mils to 100 mils wide if the MOSFET is 1in from the driver).

The internal pulldown transistor that drives DL low is robust, with a 0.25Ω (typ) on-resistance. This helps prevent DL from being pulled up due to capacitive coupling from the drain to the gate of the low-side MOSFETs when the inductor node (LX) quickly switches from ground to V<sub>IN</sub>. Applications with high-input voltages and long inductive driver traces may require rising LX edges that do not pull up the low-side MOSFETs’ gate, causing shoot-through currents. The capacitive coupling between LX and DL created by the MOSFET’s gate-to-drain capacitance (C<sub>RSS</sub>), gate-to-source capacitance (C<sub>ISS</sub> - C<sub>RSS</sub>), and additional board parasitics should not exceed the following minimum threshold:

$$V_{GS(TH)} > V_{IN} \left( \frac{C_{RSS}}{C_{ISS}} \right)$$

Typically, adding a 4700pF between DL and power ground (C<sub>NL</sub> in Figure 10), close to the low-side

MOSFETs, greatly reduces coupling. Do not exceed 22nF of total gate capacitance to prevent excessive turn-off delays.

Alternatively, shoot-through currents may be caused by a combination of fast high-side MOSFETs and slow low-side MOSFETs. If the turn-off delay time of the low-side MOSFET is too long, the high-side MOSFETs can turn on before the low-side MOSFETs have actually turned off. Adding a resistor less than 5Ω in series with BST slows down the high-side MOSFET turn-on time, eliminating the shoot-through currents without degrading the turn-off time (R<sub>BST</sub> in Figure 10). Slowing down the high-side MOSFET also reduces the LX node rise time, thereby reducing EMI and high-frequency coupling responsible for switching noise.

## Multiphase Quick-PWM Design Procedure

Firmly establish the input voltage range and maximum load current before choosing a switching frequency and inductor operating point (ripple-current ratio). The primary design trade-off lies in choosing a good switching frequency and inductor operating point, and the following four factors dictate the rest of the design:

- **Input voltage range:** The maximum value (V<sub>IN(MAX)</sub>) must accommodate the worst-case high-AC adapter voltage. The minimum value (V<sub>IN(MIN)</sub>) must account for the lowest input voltage after drops due to connectors, fuses, and battery selector switches. If there is a choice at all, lower input voltages result in better efficiency.
- **Maximum load current:** There are two values to consider. The peak load current (I<sub>LOAD(MAX)</sub>) determines the instantaneous component stresses and filtering requirements, and thus drives output capacitor selection, inductor saturation rating, and the design of the current-limit circuit. The continuous load current (I<sub>LOAD</sub>) determines the thermal stresses and thus drives the selection of input capacitors, MOSFETs, and other critical heat-contributing components. Modern notebook CPUs generally exhibit I<sub>LOAD</sub> = I<sub>LOAD(MAX)</sub> × 80%.

For multiphase systems, each phase supports a fraction of the load, depending on the current balancing. When properly balanced, the load current is evenly distributed among each phase:

$$I_{LOAD(PHASE)} = \frac{I_{LOAD}}{\eta_{TOTAL}}$$

where η<sub>TOTAL</sub> is the total number of active phases.

# MAX8770/MAX8771/MAX8772 Dual-Phase, Quick-PWM Controller for IMVP-6+ CPU Core Power Supplies

MAX8770/MAX8771/MAX8772

- **Switching frequency:** This choice determines the basic trade-off between size and efficiency. The optimal frequency is largely a function of maximum input voltage due to MOSFET switching losses that are proportional to frequency and  $V_{IN}^2$ . The optimum frequency is also a moving target, due to rapid improvements in MOSFET technology that are making higher frequencies more practical.
- **Inductor operating point:** This choice provides trade-offs between size vs. efficiency and transient response vs. output noise. Low inductor values provide better transient response and smaller physical size, but also result in lower efficiency and higher output noise due to increased ripple current. The minimum practical inductor value is one that causes the circuit to operate at the edge of critical conduction (where the inductor current just touches zero with every cycle at maximum load). Inductor values lower than this grant no further size-reduction benefit. The optimum operating point is usually found between 20% and 50% ripple current.

### Inductor Selection

The switching frequency and operating point (% ripple current or LIR) determine the inductor value as follows:

$$L = \eta_{TOTAL} \left( \frac{V_{IN} - V_{OUT}}{f_{SW} I_{LOAD(MAX)} LIR} \right) \left( \frac{V_{OUT}}{V_{IN}} \right)$$

where  $\eta_{TOTAL}$  is the total number of phases.

Find a low-loss inductor having the lowest possible DC resistance that fits in the allotted dimensions. Ferrite cores are often the best choice, although powdered iron is inexpensive and can work well at 200kHz. The core must be large enough not to saturate at the peak inductor current ( $I_{PEAK}$ ):

$$I_{PEAK} = \left( \frac{I_{LOAD(MAX)}}{\eta_{TOTAL}} \right) \left( 1 + \frac{LIR}{2} \right)$$

### Transient Response

The inductor ripple current impacts transient-response performance, especially at low  $V_{IN} - V_{OUT}$  differentials. Low inductor values allow the inductor current to slew faster, replenishing charge removed from the output filter capacitors by a sudden load step. The amount of output sag is also a function of the maximum duty factor, which can be calculated from the on-time and minimum off-time. For a dual-phase controller, the worst-case output sag voltage may be determined by:

$$V_{SAG} = \frac{L(\Delta I_{LOAD(MAX)})^2 \left[ \left( \frac{V_{OUT} T_{SW}}{V_{IN}} \right) + t_{OFF(MIN)} \right]}{2C_{OUT} V_{OUT} \left[ \left( \frac{(V_{IN} - 2V_{OUT}) T_{SW}}{V_{IN}} \right) - 2t_{OFF(MIN)} \right]} + \frac{\Delta I_{LOAD(MAX)}}{2C_{OUT}} \left[ \left( \frac{V_{OUT} T_{SW}}{V_{IN}} \right) + t_{OFF(MIN)} \right]$$

where  $t_{OFF(MIN)}$  is the minimum off-time (see the *Electrical Characteristics* table).

The amount of overshoot due to stored inductor energy can be calculated as:

$$V_{SOAR} \approx \frac{(\Delta I_{LOAD(MAX)})^2 L}{2\eta_{TOTAL} C_{OUT} V_{OUT}}$$

where  $\eta_{TOTAL}$  is the total number of active phases.

### Setting the Current Limit

The minimum current-limit threshold must be high enough to support the maximum load current when the current limit is at the minimum tolerance value. The valley of the inductor current occurs at  $I_{LOAD(MAX)}$  minus half the ripple current; therefore:

$$I_{LIMIT(LOW)} > \left( \frac{I_{LOAD(MAX)}}{\eta_{TOTAL}} \right) \left( 1 - \frac{LIR}{2} \right)$$

where  $\eta_{TOTAL}$  is the total number of active phases, and  $I_{LIMIT(LOW)}$  equals the minimum current-limit threshold voltage divided by the current-sense resistor ( $R_{SENSE}$ ). For the 22.5mV default setting, the minimum current-limit threshold is 19.5mV.

# MAX8770/MAX8771/MAX8772 Dual-Phase, Quick-PWM Controller for IMVP-6+ CPU Core Power Supplies

MAX8770/MAX8771/MAX8772

## Output Capacitor Selection

The output filter capacitor must have low enough ESR to meet output ripple and load-transient requirements, yet have high enough ESR to satisfy stability requirements.

In CPU V<sub>CORE</sub> converters and other applications where the output is subject to large load transients, the output capacitor's size typically depends on how much ESR is needed to prevent the output from dipping too low under a load transient. Ignoring the sag due to finite capacitance:

$$(R_{ESR} + R_{PCB}) \leq \frac{V_{STEP}}{\Delta I_{LOAD(MAX)}}$$

In non-CPU applications, the output capacitor's size often depends on how much ESR is needed to maintain an acceptable level of output ripple voltage. The output ripple voltage of a step-down controller equals the total inductor ripple current multiplied by the output capacitor's ESR. When operating multiphase systems out-of-phase, the peak inductor currents of each phase are staggered, resulting in lower output ripple voltage by reducing the total inductor ripple current. For multiphase operation, the maximum ESR to meet ripple requirements is:

$$R_{ESR} \leq \left[ \frac{V_{IN} f_{SW} L}{(V_{IN} - \eta_{TOTAL} V_{OUT}) V_{OUT}} \right] V_{RIPPLE}$$

where  $\eta_{TOTAL}$  is the total number of active phases and  $f_{SW}$  is the switching frequency per phase. The actual capacitance value required relates to the physical size needed to achieve low ESR, as well as to the chemistry of the capacitor technology. Thus, the capacitor is usually selected by ESR and voltage rating rather than by capacitance value (this is true of polymer types).

When using low-capacity ceramic filter capacitors, capacitor size is usually determined by the capacity needed to prevent  $V_{SAG}$  and  $V_{SOAR}$  from causing problems during load transients. Generally, once enough capacitance is added to meet the overshoot requirement, undershoot at the rising load edge is no longer a problem (see the  $V_{SAG}$  and  $V_{SOAR}$  equations in the *Transient Response* section).

## Output Capacitor Stability Considerations

For Quick-PWM controllers, stability is determined by the value of the ESR zero relative to the switching frequency. The boundary of instability is given by the following equation:

$$f_{ESR} \leq \frac{f_{SW}}{\pi}$$

where:

$$f_{ESR} = \frac{1}{2\pi R_{EFF} C_{OUT}} \text{ and}$$

$$R_{EFF} = R_{ESR} + R_{DROOP} + R_{PCB}$$

where  $C_{OUT}$  is the total output capacitance,  $R_{ESR}$  is the total ESR,  $R_{SENSE}$  is the current-sense resistance ( $R_{CM} = R_{CS}$ ),  $R_{DROOP}$  is the voltage-positioning gain, and  $R_{PCB}$  is the parasitic board resistance between the output capacitors and sense resistors.

For a standard 300kHz application, the ESR zero frequency must be well below 95kHz, preferably below 50kHz. Tantalum, Sanyo POSCAP, and Panasonic SP capacitors in widespread use at the time of publication have typical ESR zero frequencies below 50kHz. In the standard application circuit, the ESR needed to support a 30mV<sub>P-P</sub> ripple is  $30mV / (40A \times 0.3) = 2.5m\Omega$ . Four 330μF/2.5V Panasonic SP (type SX) capacitors in parallel provide 1.5mΩ (max) ESR. With a 2mΩ droop and 0.5mΩ PC board resistance, the typical combined ESR results in a zero at 30kHz.

Ceramic capacitors have a high ESR zero frequency, but applications with significant voltage positioning can take advantage of their size and low ESR. Do not put high-value ceramic capacitors directly across the output without verifying that the circuit contains enough voltage positioning and series PC board resistance to ensure stability. When only using ceramic output capacitors, output overshoot ( $V_{SOAR}$ ) typically determines the minimum output capacitance requirement. Their relatively low capacitance value can cause output overshoot when stepping from full-load to no-load conditions, unless a small inductor value is used (high switching frequency) to minimize the energy transferred from inductor to capacitor during load-step recovery. The efficiency penalty for operating at 600kHz is approximately 5% when compared to the 300kHz circuit, primarily due to the high-side MOSFET switching losses.



# MAX8770/MAX8771/MAX8772 Dual-Phase, Quick-PWM Controller for IMVP-6+ CPU Core Power Supplies

MAX8770/MAX8771/MAX8772

Unstable operation manifests itself in two related but distinctly different ways: double-pulsing and feed-back loop instability. Double pulsing occurs due to noise on the output or because the ESR is so low that there is not enough voltage ramp in the output voltage signal. This “fools” the error comparator into triggering a new cycle immediately after the minimum off-time period has expired. Double pulsing is more annoying than harmful, resulting in nothing worse than increased output ripple. However, it can indicate the possible presence of loop instability due to insufficient ESR. Loop instability can result in oscillations at the output after line or load steps. Such perturbations are usually damped, but can cause the output voltage to rise above or fall below the tolerance limits.

The easiest method for checking stability is to apply a very fast zero-to-max load transient and carefully observe the output voltage ripple envelope for overshoot and ringing. It can help to simultaneously monitor the inductor current with an AC current probe. Do not allow more than one cycle of ringing after the initial step-response under/overshoot.

### Input Capacitor Selection

The input capacitor must meet the ripple current requirement ( $I_{RMS}$ ) imposed by the switching currents. The multiphase Quick-PWM controllers operate out-of-phase while the Quick-PWM slave controllers provide selectable out-of-phase or in-phase on-time triggering. Out-of-phase operation reduces the RMS input current by dividing the input current between several staggered stages. For duty cycles less than 100%/ $\eta_{OUTPH}$  per phase, the  $I_{RMS}$  requirements may be determined by the following equation:

$$I_{RMS} = \left( \frac{I_{LOAD}}{\eta_{TOTAL} V_{IN}} \right) \sqrt{\eta_{TOTAL} V_{OUT} (V_{IN} - \eta_{TOTAL} V_{OUT})}$$

where  $\eta_{TOTAL}$  is the total number of out-of-phase switching regulators. The worst-case RMS current requirement occurs when operating with  $V_{IN} = 2\eta_{TOTAL} V_{OUT}$ . At this point, the above equation simplifies to  $I_{RMS} = 0.5 \times I_{LOAD} / \eta_{TOTAL}$ .

For most applications, nontantalum chemistries (ceramic, aluminum, or OS-CON) are preferred due to their resistance to inrush surge currents typical of systems with a mechanical switch or connector in series with the input. If the Quick-PWM controller is operated as the second stage of a two-stage power-conversion system, tantalum input capacitors are acceptable. In either configuration, choose an input capacitor that exhibits less than +10°C temperature rise at the RMS input current for optimal circuit longevity.

### Power MOSFET Selection

Most of the following MOSFET guidelines focus on the challenge of obtaining high load-current capability when using high-voltage (>20V) AC adapters. Low-current applications usually require less attention.

The high-side MOSFET ( $N_H$ ) must be able to dissipate the resistive losses plus the switching losses at both  $V_{IN(MIN)}$  and  $V_{IN(MAX)}$ . Calculate both of these sums. Ideally, the losses at  $V_{IN(MIN)}$  should be roughly equal to losses at  $V_{IN(MAX)}$ , with lower losses in between. If the losses at  $V_{IN(MIN)}$  are significantly higher than the losses at  $V_{IN(MAX)}$ , consider increasing the size of  $N_H$  (reducing  $R_{DS(ON)}$  but with higher  $C_{GATE}$ ). Conversely, if the losses at  $V_{IN(MAX)}$  are significantly higher than the losses at  $V_{IN(MIN)}$ , consider reducing the size of  $N_H$  (increasing  $R_{DS(ON)}$  to lower  $C_{GATE}$ ). If  $V_{IN}$  does not vary over a wide range, the minimum power dissipation occurs where the resistive losses equal the switching losses.

Choose a low-side MOSFET that has the lowest possible on-resistance ( $R_{DS(ON)}$ ), comes in a moderate-sized package (i.e., one or two 8-pin SOs, DPAK, or D<sup>2</sup>PAK), and is reasonably priced. Make sure that the DL gate driver can supply sufficient current to support the gate charge and the current injected into the parasitic gate-to-drain capacitor caused by the high-side MOSFET turning on; otherwise, cross-conduction problems may occur (see the *MOSFET Gate Driver* section).

### MOSFET Power Dissipation

Worst-case conduction losses occur at the duty factor extremes. For the high-side MOSFET ( $N_H$ ), the worst-case power dissipation due to resistance occurs at the minimum input voltage:

$$PD (N_H \text{ Resistive}) = \left( \frac{V_{OUT}}{V_{IN}} \right) \left( \frac{I_{LOAD}}{\eta_{TOTAL}} \right)^2 R_{DS(ON)}$$

where  $\eta_{TOTAL}$  is the total number of phases.

Generally, a small high-side MOSFET is desired to reduce switching losses at high input voltages. However, the  $R_{DS(ON)}$  required to stay within package power dissipation often limits how small the MOSFET can be. Again, the optimum occurs when the switching losses equal the conduction ( $R_{DS(ON)}$ ) losses. High-side switching losses do not usually become an issue until the input is greater than approximately 15V.

Calculating the power dissipation in high-side MOSFET ( $N_H$ ) due to switching losses is difficult since it must allow for difficult quantifying factors that influence the turn-on and turn-off times. These factors include the internal gate resistance, gate charge, threshold volt-

## MAX8770/MAX8771/MAX8772 Dual-Phase, Quick-PWM Controller for IMVP-6+ CPU Core Power Supplies

age, source inductance, and PC board layout characteristics. The following switching-loss calculation provides only a very rough estimate and is no substitute for breadboard evaluation, preferably including verification using a thermocouple mounted on  $N_H$ :

$$PD(N_H \text{ SWITCHING}) = \left( \frac{V_{IN(MAX)} I_{LOAD} f_{SW}}{\eta_{TOTAL}} \right) \left( \frac{Q_{G(SW)}}{I_{GATE}} \right) + \frac{C_{OSS} V_{IN}^2 f_{SW}}{2}$$

where  $C_{OSS}$  is the  $N_H$  MOSFET's output capacitance,  $Q_{G(SW)}$  is the charge needed to turn on the  $N_H$  MOSFET, and  $I_{GATE}$  is the peak gate-drive source/sink current (2.2A typ).

Switching losses in the high-side MOSFET can become an insidious heat problem when maximum AC adapter voltages are applied due to the squared term in the  $C \times V_{IN}^2 \times f_{SW}$  switching-loss equation. If the high-side MOSFET chosen for adequate  $R_{DS(ON)}$  at low battery voltages becomes extraordinarily hot when biased from  $V_{IN(MAX)}$ , consider choosing another MOSFET with lower parasitic capacitance.

For the low-side MOSFET ( $N_L$ ), the worst-case power dissipation always occurs at maximum input voltage:

$$PD(N_L \text{ RESISTIVE}) = \left[ 1 - \left( \frac{V_{OUT}}{V_{IN(MAX)}} \right) \right] \left( \frac{I_{LOAD}}{\eta_{TOTAL}} \right)^2 R_{DS(ON)}$$

The worst case for MOSFET power dissipation occurs under heavy overloads that are greater than  $I_{LOAD(MAX)}$ , but are not quite high enough to exceed the current limit and cause the fault latch to trip. To protect against this possibility, you can “overdesign” the circuit to tolerate:

$$I_{LOAD} = \eta_{TOTAL} \left( I_{VALLEY(MAX)} + \frac{\Delta I_{INDUCTOR}}{2} \right)$$

$$= \eta_{TOTAL} I_{VALLEY(MAX)} + \left( \frac{I_{LOAD(MAX)} L_{IR}}{2} \right)$$

where  $I_{VALLEY(MAX)}$  is the maximum valley current allowed by the current-limit circuit, including threshold tolerance and on-resistance variation. The MOSFETs must have a good size heatsink to handle the overload power dissipation.

Choose a Schottky diode ( $D_L$ ) with a forward voltage low enough to prevent the low-side MOSFET body diode from turning on during the dead time. Select a diode that can handle the load current per phase during the dead times. This diode is optional and can be removed if efficiency is not critical.

### Boost Capacitors

The boost capacitors ( $C_{BST}$ ) must be selected large enough to handle the gate-charging requirements of the high-side MOSFETs. Typically, 0.1 $\mu$ F ceramic capacitors work well for low-power applications driving medium-sized MOSFETs. However, high-current applications driving large, high-side MOSFETs require boost capacitors larger than 0.1 $\mu$ F. For these applications, select the boost capacitors to avoid discharging the capacitor more than 200mV while charging the high side MOSFETs' gates:

$$C_{BST} = \frac{N \times Q_{GATE}}{200mV}$$

where  $N$  is the number of high side MOSFETs used for one regulator, and  $Q_{GATE}$  is the gate charge specified in the MOSFET's data sheet. For example, assume (2) IRF7811W n-channel MOSFETs are used on the high side. According to the manufacturer's data sheet, a single IRF7811W has a maximum gate charge of 24nC ( $V_{GS} = 5V$ ). Using the above equation, the required boost capacitance would be:

$$C_{BST} = \frac{2 \times 24nC}{200mV} = 0.24\mu F$$

Selecting the closest standard value, this example requires a 0.22 $\mu$ F ceramic capacitor.

### Current-Balance Compensation (CCI)

The current-balance compensation capacitor ( $C_{CCI}$ ) integrates the difference between the main and secondary current-sense voltages. The internal compensation resistor ( $R_{CCI} = 200k\Omega$ ) improves transient response by increasing the phase margin. This allows the dynamics of the current-balance loop to be optimized. Excessively large capacitor values increase the integration time constant, resulting in larger current differences between the phases during transients. Excessively small capacitor values allow the current loop to respond cycle-by-cycle, but can result in small DC current variations between the phases. Likewise, excessively large resistor values can also cause DC current variations between the phases. Small resistor values reduce the phase margin, resulting in marginal

# MAX8770/MAX8771/MAX8772 Dual-Phase, Quick-PWM Controller for IMVP-6+ CPU Core Power Supplies

MAX8770/MAX8771/MAX8772

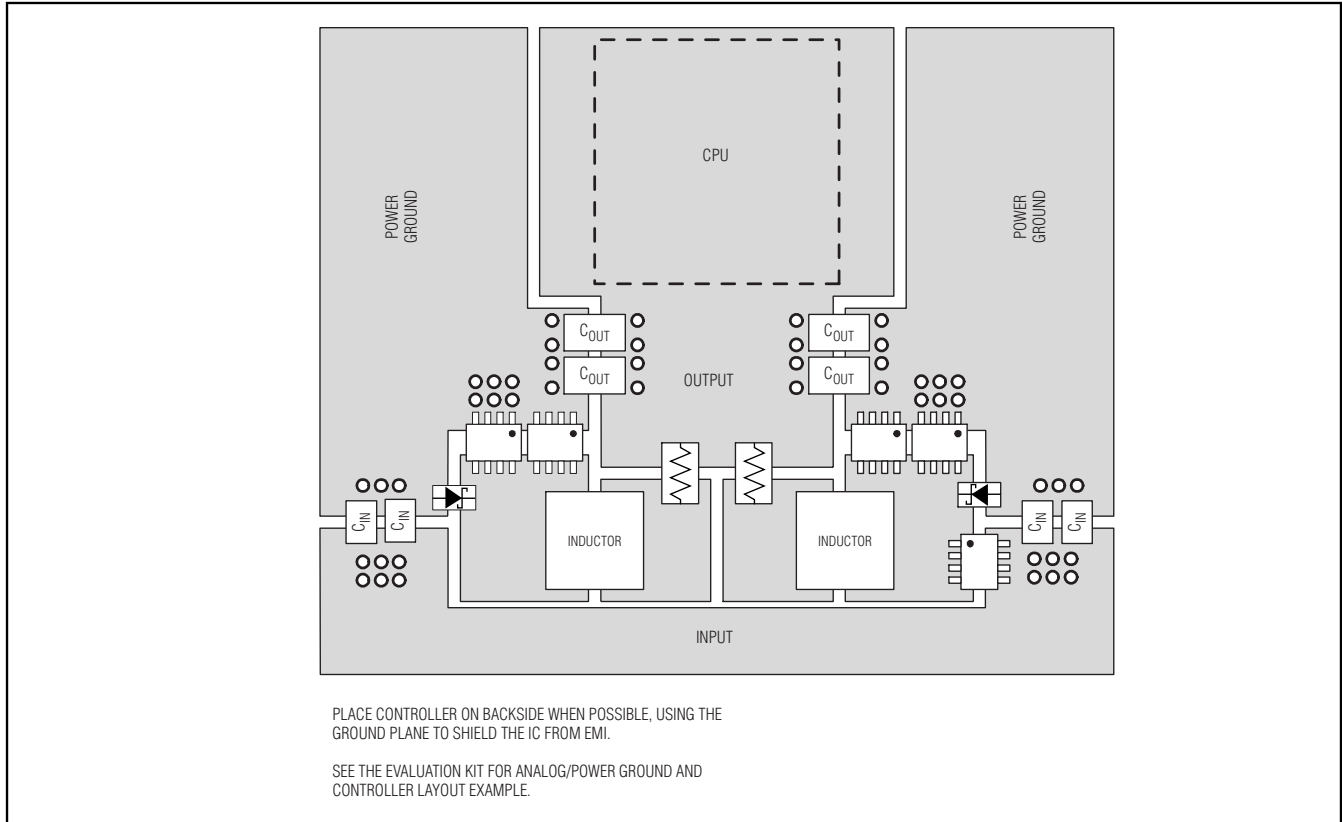

Figure 11. PC Board Layout Example

stability in the current-balance loop. For most applications, a 470pF capacitor from CCI to the switching regulator's output works well.

Connecting the compensation network to the output (V<sub>OUT</sub>) allows the controller to feed-forward the output-voltage signal, especially during transients. To reduce noise pickup in applications that have a widely distributed layout, it is sometimes helpful to connect the compensation network to the quiet analog ground rather than V<sub>OUT</sub>.

### Voltage Positioning and Loop Compensation

Voltage positioning dynamically lowers the output voltage in response to the load current, reducing the output capacitance and processor's power-dissipation requirements. The controller uses a transconductance amplifier to set the transient and DC output voltage droop (Figure 2) as a function of the load. This adjustability allows flexibility in the selected current-sense resistor value or inductor DCR, and allows smaller cur-

rent-sense resistance to be used, reducing the overall power dissipated.

#### Steady-State Voltage Positioning

Connect a resistor (R<sub>FB</sub>) between FB and V<sub>OUT</sub> to set the DC steady-state droop (load line) based on the required voltage-positioning slope (R<sub>DROOP</sub>):

$$R_{FB} = \frac{R_{DROOP}}{R_{SENSE}G_{m(FB)}}$$

where the effective current-sense resistance (R<sub>SENSE</sub>) depends on the current-sense method (see the *Current Sense* section), and the voltage-positioning amplifier's transconductance (G<sub>m(FB)</sub>) is typically 600μS, as defined in the *Electrical Characteristics* table. The controller sums together the input signals of the current-sense inputs (CSP<sub>-</sub>, CSN<sub>-</sub>).

When the inductors' DCR is used as the current-sense element (R<sub>SENSE</sub> = R<sub>DCR</sub>), each current-sense input should include an NTC thermistor to minimize the temperature dependence of the voltage-positioning slope.



# MAX8770/MAX8771/MAX8772 Dual-Phase, Quick-PWM Controller for IMVP-6+ CPU Core Power Supplies

MAX8770/MAX8771/MAX8772

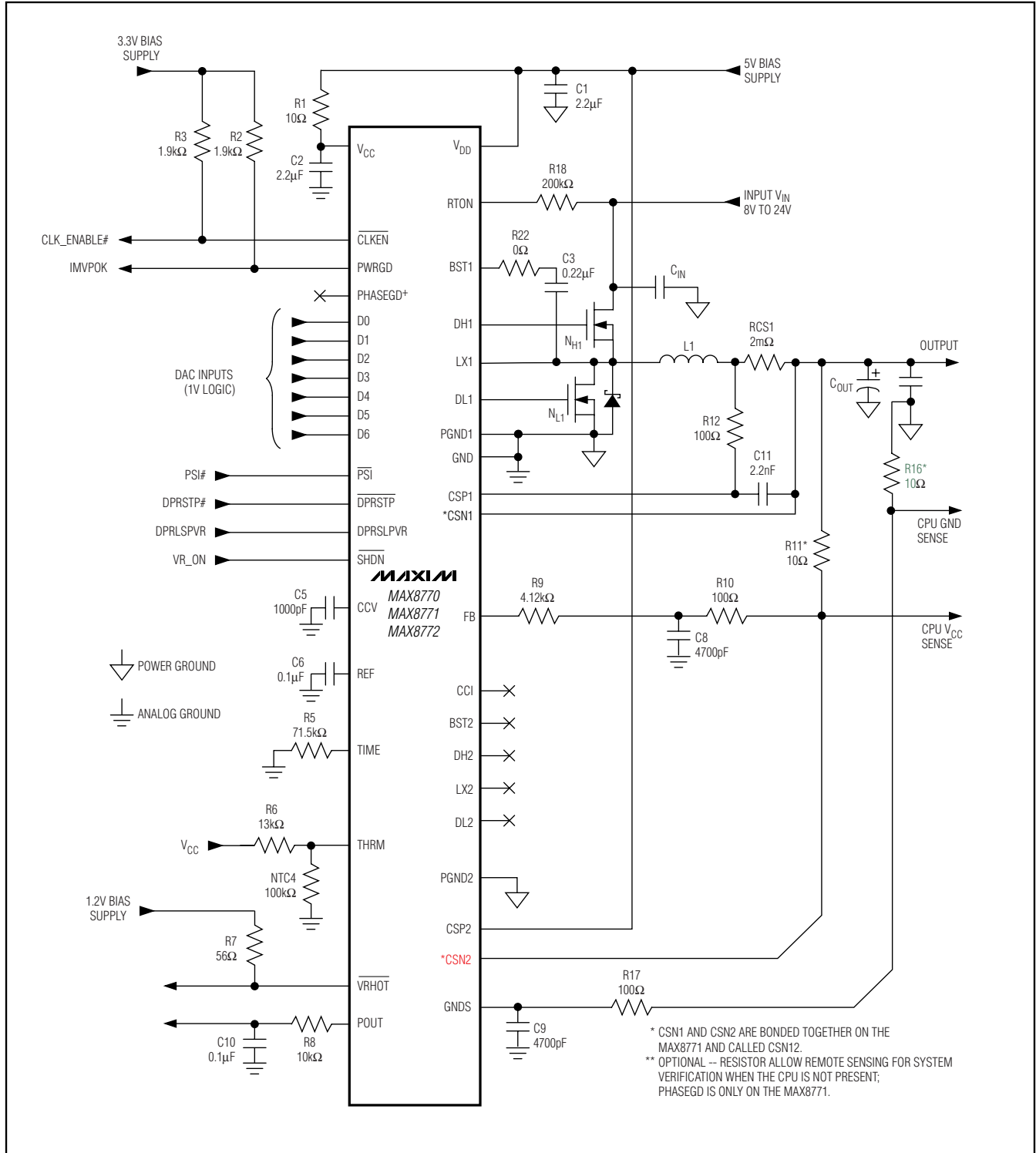

Figure 12. Single-Phase ULV Design

# MAX8770/MAX8771/MAX8772 Dual-Phase, Quick-PWM Controller for IMVP-6+ CPU Core Power Supplies

MAX8770/MAX8771/MAX8772

## Minimum Input-Voltage Requirements and Dropout Performance

The output voltage-adjustable range for continuous-conduction operation is restricted by the nonadjustable minimum off-time one-shot and the number of phases. For best dropout performance, use the slower (200kHz) on-time settings. When working with low input voltages, the duty-factor limit must be calculated using worst-case values for on- and off-times.

Manufacturing tolerances and internal propagation delays introduce an error to the on-times. This error is greater at higher frequencies. Also, keep in mind that transient response performance of buck regulators operated too close to dropout is poor, and bulk output capacitance must often be added (see the  $V_{SAG}$  equation in the *Design Procedure* section).

The absolute point of dropout is when the inductor current ramps down during the minimum off-time ( $\Delta I_{DOWN}$ ) as much as it ramps up during the on-time ( $\Delta I_{UP}$ ). The ratio  $h = \Delta I_{UP}/\Delta I_{DOWN}$  is an indicator of the ability to slew the inductor current higher in response to increased load, and must always be greater than 1. As  $h$  approaches 1, the absolute minimum dropout point, the inductor current cannot increase as much during each switching cycle and  $V_{SAG}$  greatly increases unless additional output capacitance is used.

A reasonable minimum value for  $h$  is 1.5, but adjusting this up or down allows tradeoffs between  $V_{SAG}$ , output capacitance, and minimum operating voltage. For a given value of  $h$ , the minimum operating voltage can be calculated as:

$$V_{IN(MIN)} = \left[ \frac{V_{VID} - V_{DROOP} + V_{CHG}}{1 - h \times t_{OFF(MIN)} f_{SW}} \right]$$

where  $V_{DROOP}$  is the voltage-positioning droop,  $V_{CHG}$  is the parasitic voltage drops in the charge path (see the *On-Time One-Shot* section) and  $t_{OFF(MIN)}$  is from the *Electrical Characteristics* table. The absolute minimum input voltage is calculated with  $h = 1$ .

If the calculated  $V_{IN(MIN)}$  is greater than the required minimum input voltage, then reduce the operating frequency or add output capacitance to obtain an acceptable  $V_{SAG}$ . If operation near dropout is anticipated, calculate  $V_{SAG}$  to be sure of adequate transient response.

Dropout design example:

$$V_{VID} = 1.15V$$

$$f_{SW} = 300kHz$$

$$t_{OFF(MIN)} = 375ns$$

$$V_{DROOP} = 2.1mV/A \times 44A = 92.4mV$$

$$V_{CHG} = 150mV \text{ (44A Load)}$$

$$h = 1.5$$

$$V_{IN(MIN)} = \left[ \frac{1.15V - 92.4mV + 150mV}{1 - (0.375\mu s \times 1.5 \times 300kHz)} \right] = 1.45V$$

Calculating again with  $h = 1$  gives the absolute limit of dropout:

$$V_{IN(MIN)} = \left[ \frac{1.15V - 92.4mV + 150mV}{1 - (0.375\mu s \times 1.0 \times 300kHz)} \right] = 1.36V$$

Therefore,  $V_{IN}$  must be greater than 4.1V, even with very large output capacitance, and a practical input voltage with reasonable output capacitance would be 5.0V.

## Applications Information

### PC Board Layout Guidelines

Careful PC board layout is critical to achieve low switching losses and clean, stable operation. The switching power stage requires particular attention (Figure 11). If possible, mount all the power components on the top side of the board with their ground terminals flush against one another. Follow these guidelines for good PC board layout:

- 1) Keep the high-current paths short, especially at the ground terminals. This is essential for stable, jitter-free operation.
- 2) Connect all analog grounds to a separate solid copper plane, which connects to the GND pin of the Quick-PWM controller. This includes the  $V_{CC}$  bypass capacitor, REF and GNDS bypass capacitors, and compensation (CCV) components.
- 3) Keep the power traces and load connections short. This is essential for high efficiency. The use of thick copper PC boards (2oz vs. 1oz) can enhance full-load efficiency by 1% or more. Correctly routing PC board traces is a difficult task that must be approached in terms of fractions of centimeters, where a single  $m\Omega$  of excess trace resistance causes a measurable efficiency penalty.
- 4) Keep the high-current, gate-driver traces (DL, DH, LX, and BST) short and wide to minimize trace resistance and inductance. This is essential for high-

# MAX8770/MAX8771/MAX8772 Dual-Phase, Quick-PWM Controller for IMVP-6+ CPU Core Power Supplies

power MOSFETs that require low-impedance gate drivers to avoid shoot-through currents.

- 5) CSP\_ and CSN\_ connections for current limiting and voltage positioning must be made using Kelvin-sense connections to guarantee the current-sense accuracy.
- 6) When trade-offs in trace lengths must be made, it is preferable to allow the inductor charging path to be made longer than the discharge path. For example, it is better to allow some extra distance between the input capacitors and the high-side MOSFET than to allow distance between the inductor and the low-side MOSFET or between the inductor and the output filter capacitor.
- 7) Route high-speed switching nodes away from sensitive analog areas (REF, CCV, CCI, FB, CSP\_, CSN\_, etc.).

### Layout Procedure

Place the power components first, with ground terminals adjacent (low-side MOSFET source, C<sub>IN</sub>, C<sub>OUT</sub>, and D1 anode). If possible, make all these connections on the top layer with wide, copper-filled areas:

Mount the controller IC adjacent to the low-side MOSFET. The DL gate traces must be short and wide (50 mils to 100 mils wide if the MOSFET is 1in from the controller IC). Group the gate-drive components (BST capacitors, V<sub>DD</sub> bypass capacitor) together near the controller IC.

Make the DC-DC controller ground connections as shown in the *Standard Application Circuits*. This diagram can be viewed as having four separate ground planes: input/output ground, where all the high-power components go; the power ground plane, where the PGND pin and V<sub>DD</sub> bypass capacitor go; the master's analog ground plane where sensitive analog components, the master's GND pin, and V<sub>CC</sub> bypass capacitor go; and the slave's analog ground plane where the slave's GND pin and V<sub>CC</sub> bypass capacitor go. The master's GND plane must meet the PGND plane only at a single point directly beneath the IC. Similarly, the slave's GND plane must meet the PGND plane only at a single point directly beneath the IC. The respective master and slave ground planes should connect to the high-power output ground with a short metal trace from PGND to the source of the low-side MOSFET (the middle of the star ground). This point must also be very close to the output capacitor ground terminal.

Connect the output power planes (V<sub>CORE</sub> and system ground planes) directly to the output filter capacitor positive and negative terminals with multiple vias. Place the entire DC-DC converter circuit as close to the CPU as is practical.

### Chip Information

TRANSISTOR COUNT: 8990  
PROCESS: BiCMOS

### Pin Configurations

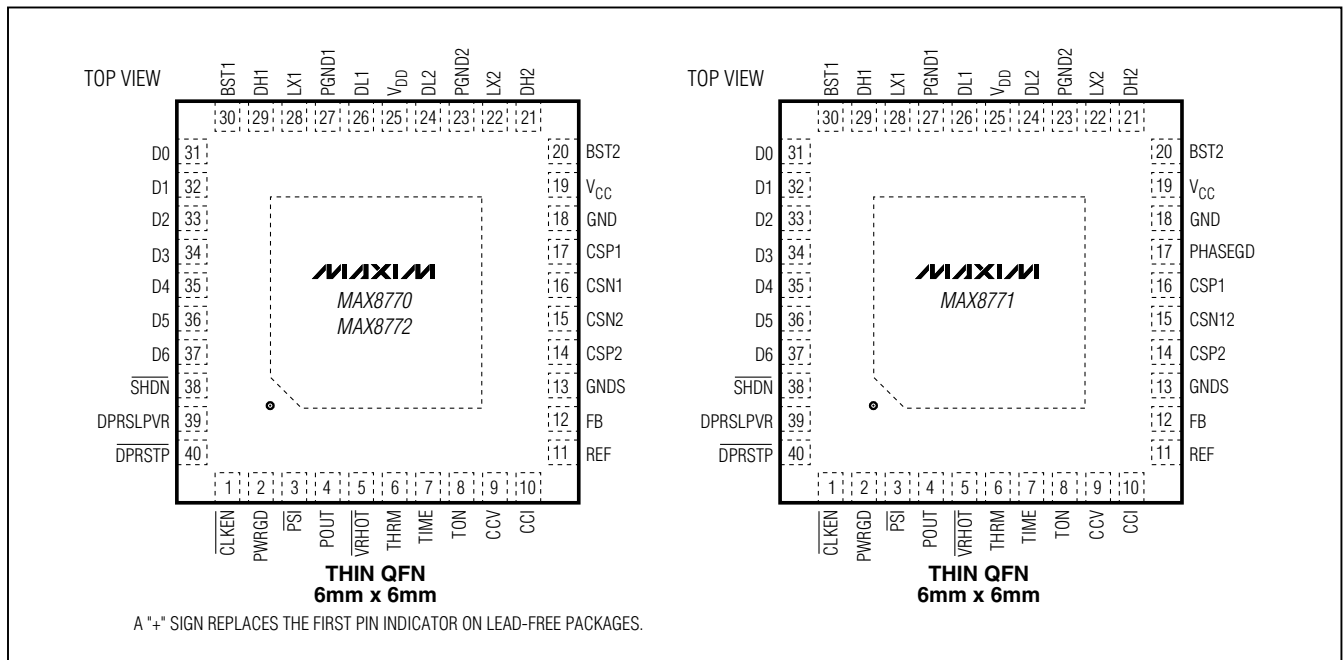

# MAX8770/MAX8771/MAX8772 Dual-Phase, Quick-PWM Controller for IMVP-6+ CPU Core Power Supplies

## Package Information

(The package drawing(s) in this data sheet may not reflect the most current specifications. For the latest package outline information, go to [www.maxim-ic.com/packages](http://www.maxim-ic.com/packages).)

MAX8770/MAX8771/MAX8772

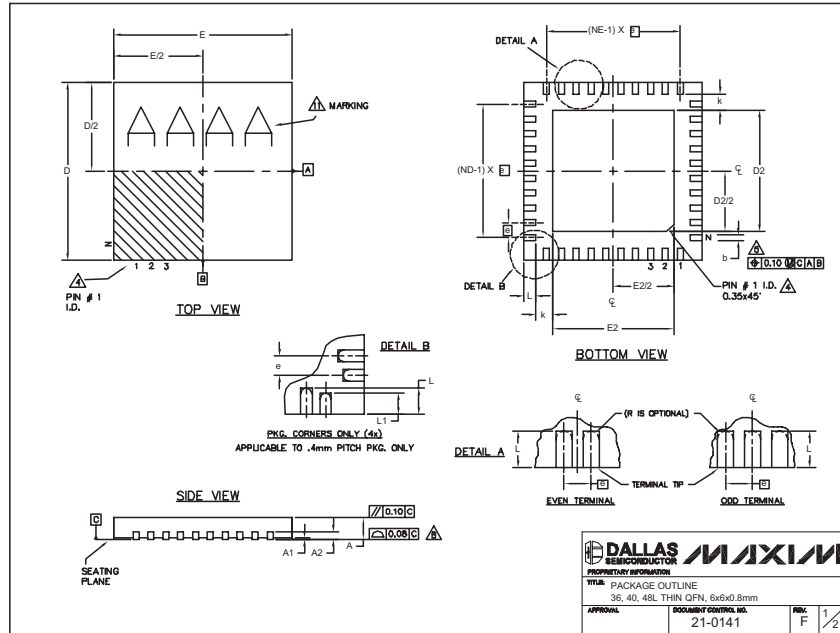

COMMON DIMENSIONS									
PKG. SYMBOL	36L 6x6			40L 6x6			48L 6x6		
	MIN.	NOM.	MAX.	MIN.	NOM.	MAX.	MIN.	NOM.	MAX.
A	0.70	0.75	0.80	0.70	0.75	0.80	0.70	0.75	0.80
A1	0	0.02	0.05	0	0.02	0.05	0	—	0.05
A2	0.20 REF.			0.20 REF.			0.20 REF.		
b	0.20	0.25	0.30	0.20	0.25	0.30	0.15	0.20	0.25
D	5.90	6.00	6.10	5.90	6.00	6.10	5.90	6.00	6.10
E	5.90	6.00	6.10	5.90	6.00	6.10	5.90	6.00	6.10
e	0.50 BSC.			0.50 BSC.			0.40 BSC.		
k	0.25	—	—	0.25	—	—	0.25	0.35	0.45
L	0.45	0.55	0.65	0.30	0.40	0.50	0.40	0.50	0.60
L1	—	—	—	—	—	—	0.30	0.40	0.50
N	36			40			48		
ND	9			10			12		
NE	9			10			12		
JEDEC	WJJD-1			WJJD-2			—		

PKG. CODES	DZ			E2			DOWN BONDS ALLOWED
	MIN.	NOM.	MAX.	MIN.	NOM.	MAX.	
T3666-2	3.60	3.70	3.80	3.60	3.70	3.80	YES
T3666-3	3.60	3.70	3.80	3.60	3.70	3.80	NO
T3666N-1	3.60	3.70	3.80	3.60	3.70	3.80	NO
T4066-2	4.00	4.10	4.20	4.00	4.10	4.20	YES
T4066-3	4.00	4.10	4.20	4.00	4.10	4.20	YES
T4066-4	4.00	4.10	4.20	4.00	4.10	4.20	NO
T4066-5	4.00	4.10	4.20	4.00	4.10	4.20	NO
T4866-1	4.20	4.30	4.40	4.20	4.30	4.40	YES

NOTES:

1. DIMENSIONING & TOLERANCING CONFORM TO ASME Y14.5M-1994.
2. ALL DIMENSIONS ARE IN MILLIMETERS; ANGLES ARE IN DEGREES.
3. N IS THE TOTAL NUMBER OF TERMINALS.
4. THE TERMINAL #1 IDENTIFIER AND TERMINAL NUMBERING CONVENTION SHALL CONFORM TO JESD 95-1 SPP-012. DETAILS OF TERMINAL #1 IDENTIFIER ARE OPTIONAL, BUT MUST BE LOCATED WITHIN THE ZONE INDICATED. THE TERMINAL #1 IDENTIFIER MAY BE EITHER A MOLD OR MARKED FEATURE.
5. DIMENSION b APPLIES TO METALLIZED TERMINAL AND IS MEASURED BETWEEN 0.25 mm AND 0.30 mm FROM TERMINAL TIP.
6. ND AND NE REFER TO THE NUMBER OF TERMINALS ON EACH D AND E SIDE RESPECTIVELY.
7. DEPOPULATION IS POSSIBLE IN A SYMMETRICAL FASHION.
8. COPLANARITY APPLIES TO THE EXPOSED HEAT SINK SLUG AS WELL AS THE TERMINALS.
9. DRAWING CONFORMS TO JEDEC MO220, EXCEPT FOR 0.4mm LEAD PITCH PACKAGE T4866-1.
10. WARPAGE SHALL NOT EXCEED 0.10 mm.
11. MARKING IS FOR PACKAGE ORIENTATION REFERENCE ONLY.
12. NUMBER OF LEADS SHOWN FOR REFERENCE ONLY.

DALLAS SEMICONDUCTOR		MAXIM	
PROPRIETARY INFORMATION			
TITLE: PACKAGE OUTLINE			
36, 40, 48L THIN QFN, 6x6x0.8mm			
APPROVAL:	DOCUMENT CONTROL NO.:	REV.:	2/2
	21-0141	F	

Maxim cannot assume responsibility for use of any circuitry other than circuitry entirely embodied in a Maxim product. No circuit patent licenses are implied. Maxim reserves the right to change the circuitry and specifications without notice at any time.