



# Ultra-Low-Noise, High PSRR, Low-Dropout, 120mA Linear Regulators

## General Description

The MAX8510/MAX8511/MAX8512 ultra-low-noise, low-dropout (LDO) linear regulators are designed to deliver up to 120mA continuous output current. These regulators achieve a low 120mV dropout for 120mA load current. The MAX8510 uses an advanced architecture to achieve ultra-low output voltage noise of 11 $\mu$ V<sub>RMS</sub> and PSRR of 54dB at 100kHz.

The MAX8511 does not require a bypass capacitor, hence achieving the smallest PC board area. The MAX8512's output voltage can be adjusted with an external divider.

The MAX8510/MAX8511 are preset to a variety of voltages in the 1.5V to 4.5V range. Designed with a P-channel MOSFET series pass transistor, the MAX8510/MAX8511/MAX8512 maintain very low ground current (40 $\mu$ A).

The regulators are designed and optimized to work with low-value, low-cost ceramic capacitors. The MAX8510 requires only 1 $\mu$ F (typ) of output capacitance for stability with any load. When disabled, current consumption drops to below 1 $\mu$ A.

Package options include a 5-pin SC70 and a tiny 2mm x 2mm x 0.8mm TDFN package.

## Applications

Cellular and Cordless Phones  
PDA and Palmtop Computers  
Base Stations  
Bluetooth Portable Radios and Accessories  
Wireless LANs  
Digital Cameras  
Personal Stereos  
Portable and Battery-Powered Equipment

*Output Voltage Selector Guide appears at end of data sheet.*

## Features

- ◆ Space-Saving SC70 and TDFN (2mm x 2mm) Packages
- ◆ 11 $\mu$ V<sub>RMS</sub> Output Noise at 100Hz to 100kHz Bandwidth (MAX8510)
- ◆ 78dB PSRR at 1kHz (MAX8510)
- ◆ 120mV Dropout at 120mA Load
- ◆ Stable with 1 $\mu$ F Ceramic Capacitor for Any Load
- ◆ Guaranteed 120mA Output
- ◆ Only Need Input and Output Capacitors (MAX8511)
- ◆ Output Voltages: 1.5V, 1.8V, 2.5V, 2.6V, 2.7V, 2.8V, 2.85V, 3V, 3.3V, 4.5V (MAX8510/MAX8511) and Adjustable (MAX8512)
- ◆ Low 40 $\mu$ A Ground Current
- ◆ Excellent Load/Line Transient
- ◆ Overcurrent and Thermal Protection

## Ordering Information

PART*	TEMP RANGE	PIN-PACKAGE
MAX8510EXKxy+T	-40°C to +85°C	5 SC70-5

\*xy is the output voltage code (see Output Voltage Selector Guide). Other versions between 1.5V and 4.5V are available in 100mV increments. Contact factory for other versions.

+ Denotes a lead(Pb)-free/RoHS-compliant package.

T = Tape and reel.

Ordering Information continued at end of data sheet.

## Typical Operating Circuits

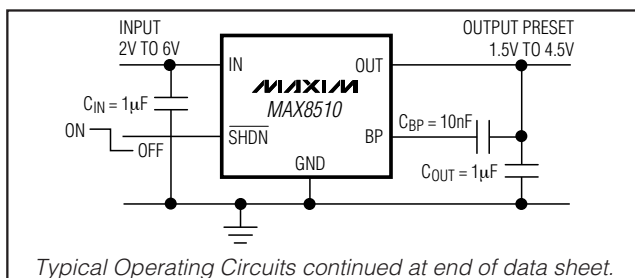

## Pin Configuration

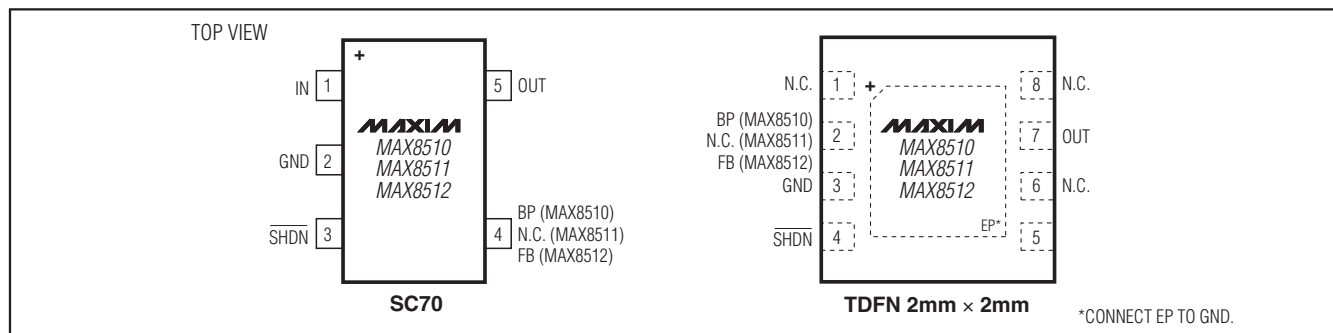

# Ultra-Low-Noise, High PSRR, Low-Dropout, 120mA Linear Regulators

## ABSOLUTE MAXIMUM RATINGS

IN to GND	-0.3V to +7V	Operating Temperature Range	-40°C to +85°C
Output Short-Circuit Duration	Infinite	Junction Temperature	+150°C
OUT, SHDN to GND	-0.3V to (IN + 0.3V)	Storage Temperature Range	-65°C to +150°C
FB, BP, N.C. to GND	-0.3V to (OUT + 0.3V)	Lead Temperature (soldering, 10s)	+300°C
Continuous Power Dissipation (T <sub>A</sub> = +70°C)		Soldering Temperature (reflow)	+260°C
5-Pin SC70 (derate 3.1mW/°C above +70°C)	0.247W		
8-Pin TDFN (derate 11.9mW/°C above = 70°C)	0.953W		

Stresses beyond those listed under "Absolute Maximum Ratings" may cause permanent damage to the device. These are stress ratings only, and functional operation of the device at these or any other conditions beyond those indicated in the operational sections of the specifications is not implied. Exposure to absolute maximum rating conditions for extended periods may affect device reliability.

## PACKAGE THERMAL CHARACTERISTICS (Note 1)

SC70	Junction-to-Ambient Thermal Resistance (θ <sub>JA</sub> )	324°C/W	TDFN	Junction-to-Ambient Thermal Resistance (θ <sub>JA</sub> )	83.9°C/W
	Junction-to-Case Thermal Resistance (θ <sub>JC</sub> )	115°C/W		Junction-to-Case Thermal Resistance (θ <sub>JC</sub> )	37°C/W

**Note 1:** Package thermal resistances were obtained using the method described in JEDEC specification JESD51-7, using a four-layer board. For detailed information on package thermal considerations, refer to [www.maxim-ic.com/thermal-tutorial](http://www.maxim-ic.com/thermal-tutorial).

## ELECTRICAL CHARACTERISTICS

(V<sub>IN</sub> = V<sub>OUT</sub> + 0.5V, T<sub>A</sub> = -40°C to +85°C, unless otherwise noted. C<sub>IN</sub> = 1μF, C<sub>OUT</sub> = 1μF, C<sub>BP</sub> = 10nF. Typical values are at +25°C; the MAX8512 is tested with 2.45V output, unless otherwise noted.) (Note 2)

PARAMETER	SYMBOL	CONDITIONS	MIN	TYP	MAX	UNITS
Input Voltage Range	V <sub>IN</sub>		2		6	V
Output Voltage Accuracy		I <sub>OUT</sub> = 1mA, T <sub>A</sub> = +25°C	-1		+1	%
		I <sub>OUT</sub> = 100μA to 80mA, T <sub>A</sub> = +25°C	-2		+2	
		I <sub>OUT</sub> = 100μA to 80mA	-3		+3	
Maximum Output Current	I <sub>OUT</sub>		120			mA
Current Limit	I <sub>LIM</sub>	V <sub>OUT</sub> = 90% of nominal value	130	200	300	mA
Dropout Voltage (Note 3)		V <sub>OUT</sub> ≥ 3V, I <sub>OUT</sub> = 80mA		80	170	mV
		V <sub>OUT</sub> ≥ 3V, I <sub>OUT</sub> = 120mA		120		
		2.5V ≤ V <sub>OUT</sub> < 3V, I <sub>OUT</sub> = 80mA		90	200	
		2.5V ≤ V <sub>OUT</sub> < 3V, I <sub>OUT</sub> = 120mA		135		
		2V ≤ V <sub>OUT</sub> < 2.5V, I <sub>OUT</sub> = 80mA		120	250	
		2V ≤ V <sub>OUT</sub> < 2.5V, I <sub>OUT</sub> = 120mA		180		
Ground Current	I <sub>Q</sub>	I <sub>OUT</sub> = 0.05mA		40	90	μA
		V <sub>IN</sub> = V <sub>OUT</sub> (nom) - 0.1V, I <sub>OUT</sub> = 0mA		220	500	
Line Regulation	V <sub>LNR</sub>	V <sub>IN</sub> = (V <sub>OUT</sub> + 0.5V) to 6V, I <sub>OUT</sub> = 0.1mA		0.001		%/V
Load Regulation	V <sub>LDR</sub>	I <sub>OUT</sub> = 1mA to 80mA		0.003		%/mA
Shutdown Supply Current	I <sub>SHDN</sub>	V <sub>SHDN</sub> = 0V	T <sub>A</sub> = +25°C	0.003	1	μA
			T <sub>A</sub> = +85°C	0.05		
Ripple Rejection	PSRR	f = 1kHz, I <sub>OUT</sub> = 10mA	MAX8510	78		dB
			MAX8511/MAX8512	72		
		f = 10kHz, I <sub>OUT</sub> = 10mA	MAX8510	75		
			MAX8511/MAX8512	65		
		f = 100kHz, I <sub>OUT</sub> = 10mA	MAX8510	54		
			MAX8511/MAX8512	46		

# Ultra-Low-Noise, High PSRR, Low-Dropout, 120mA Linear Regulators

MAX8510/MAX8511/MAX8512

## ELECTRICAL CHARACTERISTICS (continued)

( $V_{IN} = V_{OUT} + 0.5V$ ,  $T_A = -40^{\circ}C$  to  $+85^{\circ}C$ , unless otherwise noted.  $C_{IN} = 1\mu F$ ,  $C_{OUT} = 1\mu F$ ,  $C_{BP} = 10nF$ . Typical values are at  $+25^{\circ}C$ ; the MAX8512 is tested with 2.45V output, unless otherwise noted.) (Note 2)

PARAMETER	SYMBOL	CONDITIONS	MIN	TYP	MAX	UNITS
Output Noise Voltage (RMS)		f = 100Hz to 100kHz, $I_{LOAD} = 10mA$	MAX8510	11		$\mu V$
			MAX8511/MAX8512	230		
		f = 100Hz to 100kHz, $I_{LOAD} = 80mA$	MAX8510	13		
			MAX8511/MAX8512	230		
Shutdown Exit Delay		$R_{LOAD} = 50\Omega$ (Note 4)			300	$\mu s$
SHDN Logic Low Level		$V_{IN} = 2V$ to $6V$			0.4	V
SHDN Logic High Level		$V_{IN} = 2V$ to $6V$	1.5			V
SHDN Input Bias Current		$V_{IN} = 6V$ , $V_{SHDN} = 0V$ or $6V$	$T_A = +25^{\circ}C$			$\mu A$
			$T_A = +85^{\circ}C$	0.01		
FB Input Bias Current (MAX8512)		$V_{IN} = 6V$ , $V_{FB} = 1.3V$	$T_A = +25^{\circ}C$	0.006	0.1	$\mu A$
			$T_A = +85^{\circ}C$	0.01		
Thermal Shutdown				160		$^{\circ}C$
Thermal-Shutdown Hysteresis				10		$^{\circ}C$

**Note 2:** Limits are 100% tested at  $+25^{\circ}C$ . Limits over operating temperature range are guaranteed by design.

**Note 3:** Dropout is defined as  $V_{IN} - V_{OUT}$  when  $V_{OUT}$  is 100mV below the value of  $V_{OUT}$  for  $V_{IN} = V_{OUT} + 0.5V$ .

**Note 4:** Time needed for  $V_{OUT}$  to reach 90% of final value.

## Typical Operating Characteristics

( $V_{IN} = V_{OUT} + 0.5V$ ,  $C_{IN} = 1\mu F$ ,  $C_{OUT} = 1\mu F$ ,  $C_{BP} = 10nF$ ,  $T_A = +25^{\circ}C$ , unless otherwise noted.)

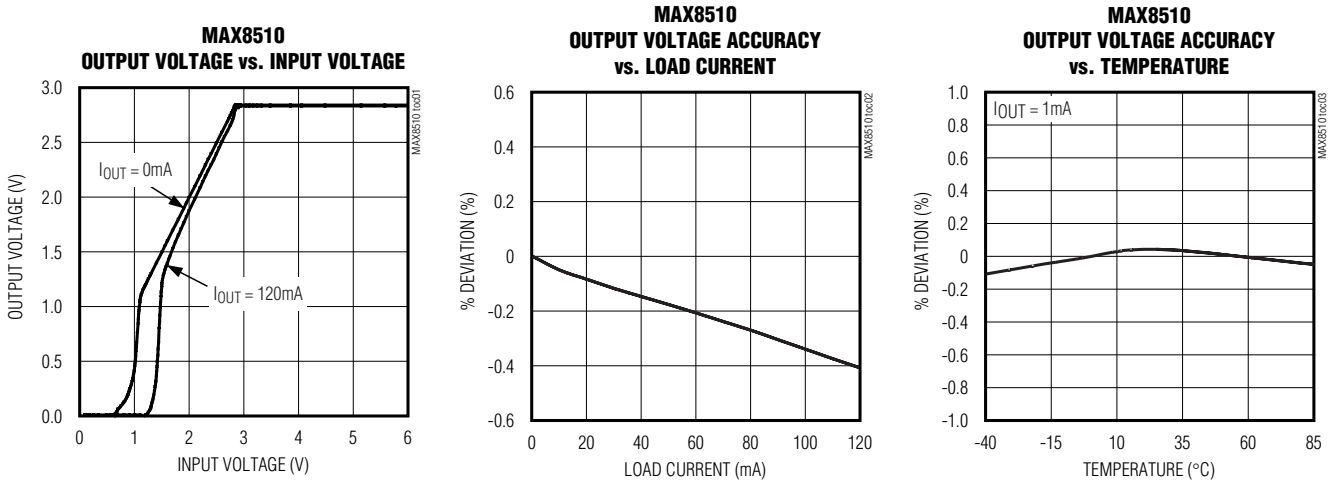

# Ultra-Low-Noise, High PSRR, Low-Dropout, 120mA Linear Regulators

## Typical Operating Characteristics (continued)

( $V_{IN} = V_{OUT} + 0.5V$ ,  $C_{IN} = 1\mu F$ ,  $C_{OUT} = 1\mu F$ ,  $C_{BP} = 10nF$ ,  $T_A = +25^\circ C$ , unless otherwise noted.)

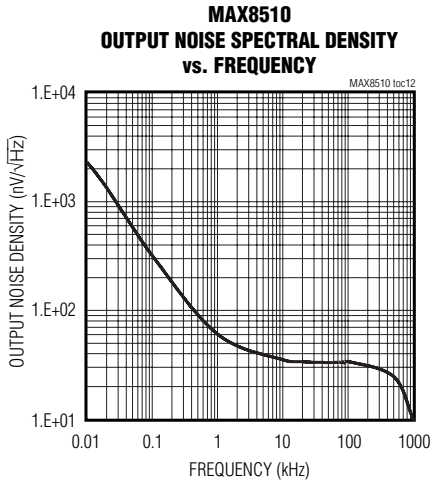
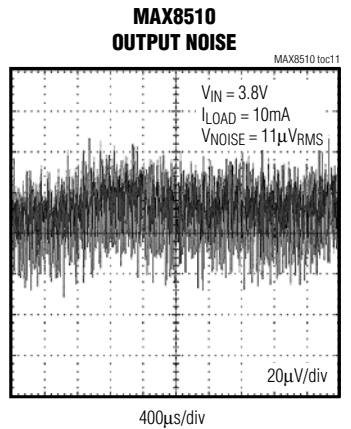
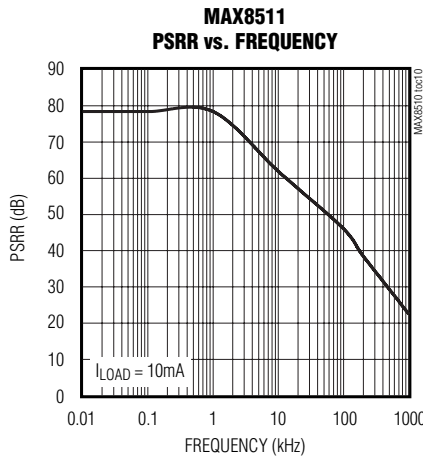
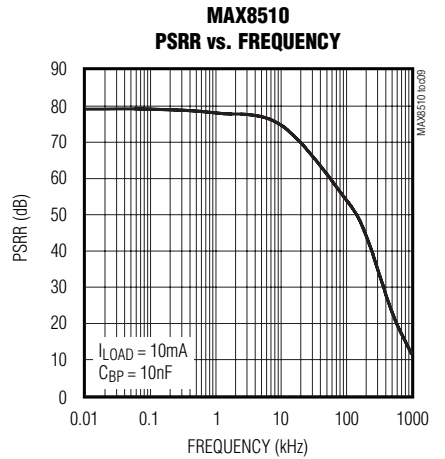
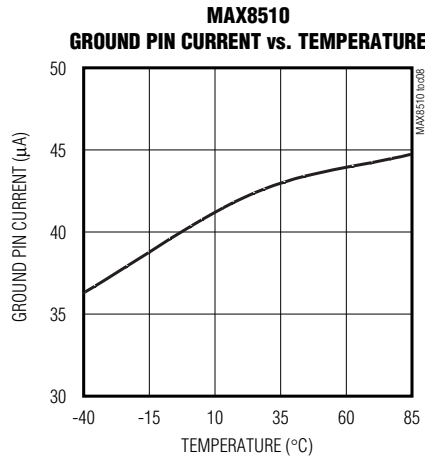
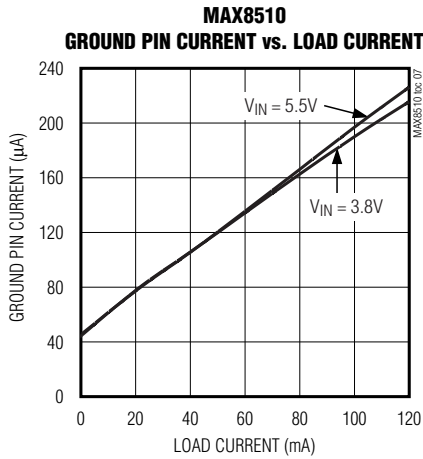
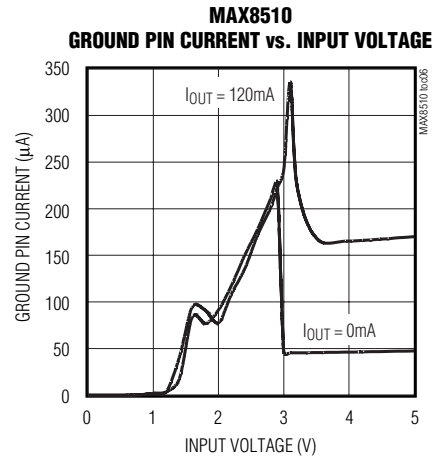
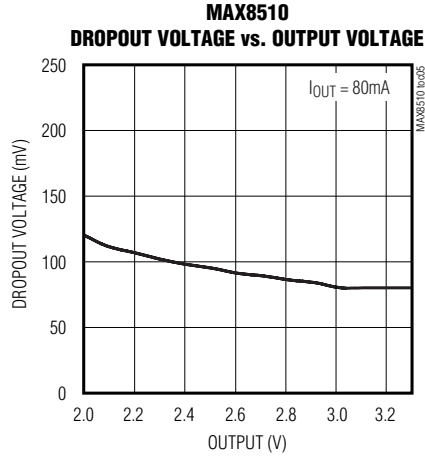
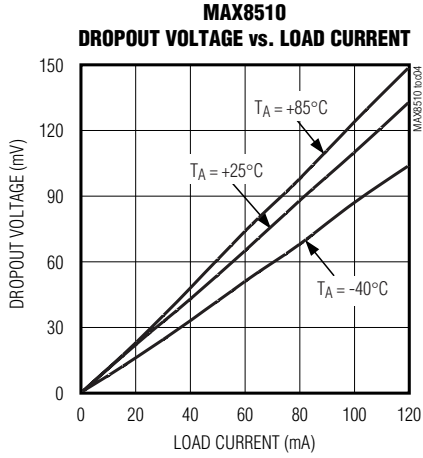

# Ultra-Low-Noise, High PSRR, Low-Dropout, 120mA Linear Regulators

## Typical Operating Characteristics (continued)

( $V_{IN} = V_{OUT} + 0.5V$ ,  $C_{IN} = 1\mu F$ ,  $C_{OUT} = 1\mu F$ ,  $C_{BP} = 10nF$ ,  $T_A = +25^\circ C$ , unless otherwise noted.)

MAX8510/MAX8511/MAX8512

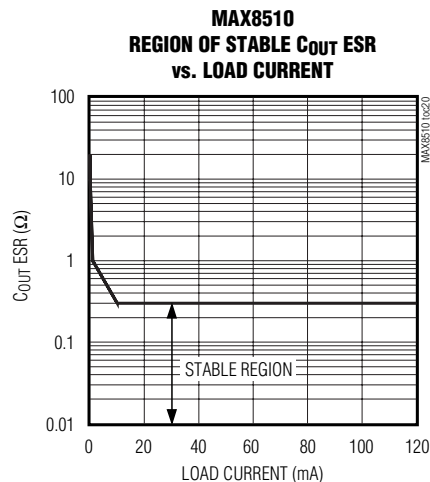
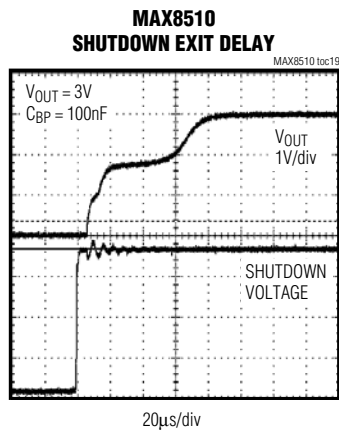
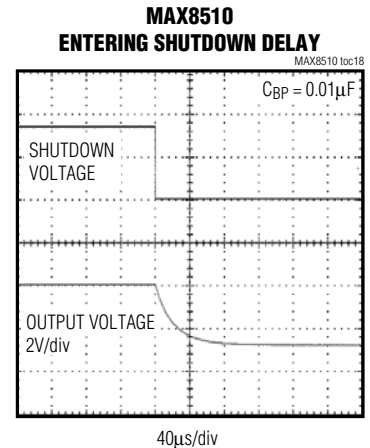
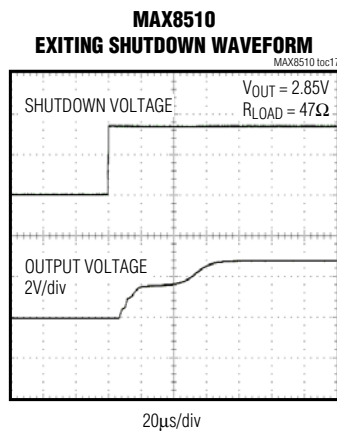
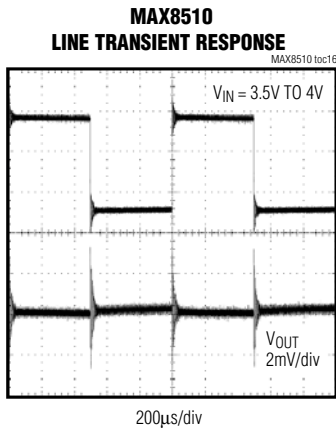
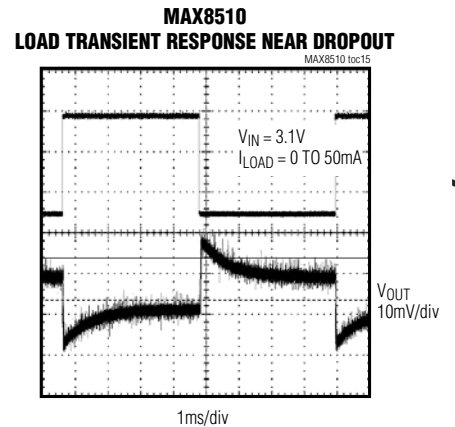
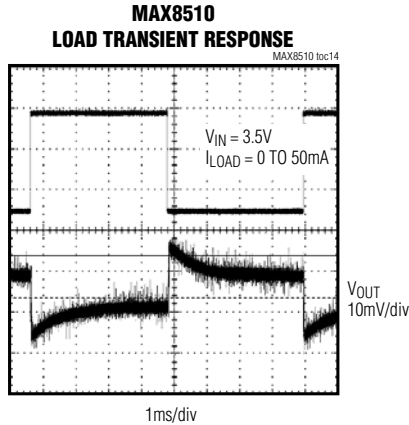
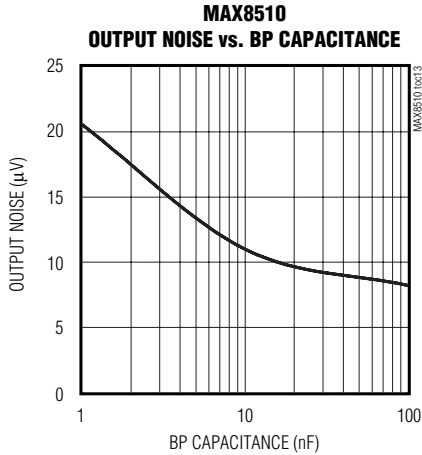

# Ultra-Low-Noise, High PSRR, Low-Dropout, 120mA Linear Regulators

## Pin Description

PIN						NAME	FUNCTION
MAX8510		MAX8511		MAX8512			
SC70	TDFN -EP	SC70	TDFN -EP	SC70	TDFN -EP		
1	5	1	5	1	5	IN	Unregulated Input Supply
2	3	2	3	2	3	GND	Ground
3	4	3	4	3	4	SHDN	Shutdown. Pull low to disable the regulator.
4	2	—	—	—	—	BP	Noise Bypass for Low-Noise Operation. Connect a 10nF capacitor from BP to OUT. BP is shorted to OUT in shutdown mode.
—	—	—	—	4	2	FB	Adjustable Output Feedback Point
5	7	5	7	5	7	OUT	Regulated Output Voltage. Bypass with a capacitor to GND. See the <i>Capacitor Selection and Regulator Stability</i> section for more details.
—	1, 6, 8	4	1, 2, 6,	—	1, 6, 8	N.C.	No connection. Not internally connected.
—	—	—	—	—	—	EP	Exposed Pad (TDFN Only). Internally connected to GND. Connect to a large ground plane to maximize thermal performance. Not intended as an electrical connection point.

## Detailed Description

The MAX8510/MAX8511/MAX8512 are ultra-low-noise, low-dropout, low-quiescent current linear regulators designed for space-restricted applications. The parts are available with preset output voltages ranging from 1.5V to 4.5V in 100mV increments. These devices can supply loads up to 120mA. As shown in the *Functional Diagram*, the MAX8510/MAX8511 consist of an innovative bandgap core and noise bypass circuit, error amplifier, P-channel pass transistor, and internal feedback voltage-divider. The MAX8512 allows for adjustable output with an external feedback network.

The 1.225V bandgap reference is connected to the error amplifier's inverting input. The error amplifier compares this reference with the feedback voltage and amplifies the difference. If the feedback voltage is lower than the reference voltage, the pass-transistor gate is pulled low. This allows more current to pass to the output and increases the output voltage. If the feedback voltage is too high, the pass transistor gate is pulled high, allowing less current to pass to the output. The output voltage is fed back through an internal resistor voltage-divider connected to the OUT pin.

An external bypass capacitor connected to BP (MAX8510) reduces noise at the output. Additional blocks include a current limiter, thermal sensor, and shutdown logic.

## Internal P-Channel Pass Transistor

The MAX8510/MAX8511/MAX8512 feature a 1Ω (typ) P-channel MOSFET pass transistor. This provides several advantages over similar designs using a PNP pass transistor, including longer battery life. The P-channel MOSFET requires no base drive, which considerably reduces quiescent current. PNP-based regulators waste considerable current in dropout when the pass transistor saturates. They also use high base-drive current under heavy loads. The MAX8510/MAX8511/MAX8512 do not suffer from these problems and consume only 40μA of quiescent current in light load and 220μA in dropout (see the *Typical Operating Characteristics*).

## Output Voltage Selection

The MAX8510/MAX8511 are supplied with factory-set output voltages from 1.5V to 4.5V, in 100mV increments (see *Ordering Information*). The MAX8512 features a user-adjustable output through an external feedback network (see the *Typical Operating Circuits*).

To set the output of the MAX8512, use the following equation:

$$R1 = R2 \times \left( \frac{V_{OUT}}{V_{REF}} - 1 \right)$$

where R2 is chosen to be less than 240kΩ and V<sub>REF</sub> = 1.225V. Use 1% or better resistors.



# Ultra-Low-Noise, High PSRR, Low-Dropout, 120mA Linear Regulators

MAX8510/MAX8511/MAX8512

## Shutdown

The MAX8510/MAX8511/MAX8512 feature a low-power shutdown mode that reduces quiescent current less than 1 $\mu$ A. Driving  $\overline{\text{SHDN}}$  low disables the voltage reference, error amplifier, gate-drive circuitry, and pass transistor (see the *Functional Diagram*), and the device output enters a high-impedance state. Connect  $\overline{\text{SHDN}}$  to IN for normal operation.

## Current Limit

The MAX8510/MAX8511/MAX8512 include a current limiter, which monitors and controls the pass transistor's gate voltage, limiting the output current to 200mA. For design purposes, consider the current limit to be 130mA (min) to 300mA (max). The output can be shorted to ground for an indefinite amount of time without damaging the part.

## Thermal-Overload Protection

Thermal-overload protection limits total power dissipation in the MAX8510/MAX8511/MAX8512. When the junction temperature exceeds  $T_J = +160^\circ\text{C}$ , the thermal sensor signals the shutdown logic, turning off the pass transistor and allowing the IC to cool down. The thermal sensor turns the pass transistor on again after the IC's junction temperature drops by  $10^\circ\text{C}$ , resulting in a pulsed output during continuous thermal-overload conditions.

Thermal-overload protection is designed to protect the MAX8510/MAX8511/MAX8512 in the event of a fault condition. For continual operation, do not exceed the absolute maximum junction temperature rating of  $T_J = +150^\circ\text{C}$ .

## Operating Region and Power Dissipation

The MAX8510/MAX8511/MAX8512 maximum power dissipation depends on the thermal resistance of the case and circuit board, the temperature difference between the die junction and ambient, and the rate of airflow. The power dissipation across the device is:

$$P = I_{\text{OUT}} (V_{\text{IN}} - V_{\text{OUT}})$$

The maximum power dissipation is:

$$P_{\text{MAX}} = (T_J - T_A) / (\theta_{\text{JC}} + \theta_{\text{CA}})$$

where  $T_J - T_A$  is the temperature difference between the MAX8510/MAX8511/MAX8512 die junction and the surrounding air,  $\theta_{\text{JC}}$  is the thermal resistance of the package, and  $\theta_{\text{CA}}$  is the thermal resistance through the PC board, copper traces, and other materials to the surrounding air.

The GND pin of the MAX8510/MAX8511/MAX8512 performs the dual function of providing an electrical connection to ground and channeling heat away. Connect the GND pin to ground using a large pad or ground plane.

## Noise Reduction

For the MAX8510, an external 0.01 $\mu$ F bypass capacitor between BP and OUT with innovative noise bypass scheme reduces output noises dramatically, exhibiting 11 $\mu$ V<sub>RMS</sub> of output voltage noise with  $C_{\text{BP}} = 0.01\mu\text{F}$  and  $C_{\text{OUT}} = 1\mu\text{F}$ . Startup time is minimized by a power-on circuit that precharges the bypass capacitor.

## Applications Information

### Capacitor Selection and Regulator Stability

Use a 1 $\mu$ F capacitor on the MAX8510/MAX8511/MAX8512 input and a 1 $\mu$ F capacitor on the output. Larger input capacitor values and lower ESRs provide better noise rejection and line-transient response. Reduce output noise and improve load-transient response, stability, and power-supply rejection by using large output capacitors. Note that some ceramic dielectrics exhibit large capacitance and ESR variation with temperature. With dielectrics such as Z5U and Y5V, it may be necessary to use a 2.2 $\mu$ F or larger output capacitor to ensure stability at temperatures below  $-10^\circ\text{C}$ . With X7R or X5R dielectrics, 1 $\mu$ F is sufficient at all operating temperatures. A graph of the region of stable  $C_{\text{OUT}}$  ESR vs. load current is shown in the *Typical Operating Characteristics*.

Use a 0.01 $\mu$ F bypass capacitor at BP (MAX8510) for low-output voltage noise. The leakage current going into the BP pin should be less than 10nA. Increasing the capacitance slightly decreases the output noise. Values above 0.1 $\mu$ F and below 0.001 $\mu$ F are not recommended.

### Noise, PSRR, and Transient Response

The MAX8510/MAX8511/MAX8512 are designed to deliver ultra-low noise and high PSRR, as well as low dropout and low quiescent currents in battery-powered systems. The MAX8510 power-supply rejection is 78dB at 1kHz and 54dB at 100kHz. The MAX8511/MAX8512 PSRR is 72dB at 1kHz and 46dB at 100kHz (see the Power-Supply Rejection Ratio vs. Frequency graph in the *Typical Operating Characteristics*).

When operating from sources other than batteries, improved supply-noise rejection and transient response can be achieved by increasing the values of the input and output bypass capacitors, and through passive filtering techniques. The *Typical Operating Characteristics* show the MAX8510/MAX8511/MAX8512 line- and load-transient responses.

# Ultra-Low-Noise, High PSRR, Low-Dropout, 120mA Linear Regulators

## Dropout Voltage

A regulator's minimum dropout voltage determines the lowest usable supply voltage. In battery-powered systems, this determines the useful end-of-life battery voltage. Because the MAX8510/MAX8511/MAX8512 use a

P-channel MOSFET pass transistor, their dropout voltage is a function of drain-to-source on-resistance ( $R_{DS(ON)}$ ) multiplied by the load current (see the *Typical Operating Characteristics*).

## Functional Diagram

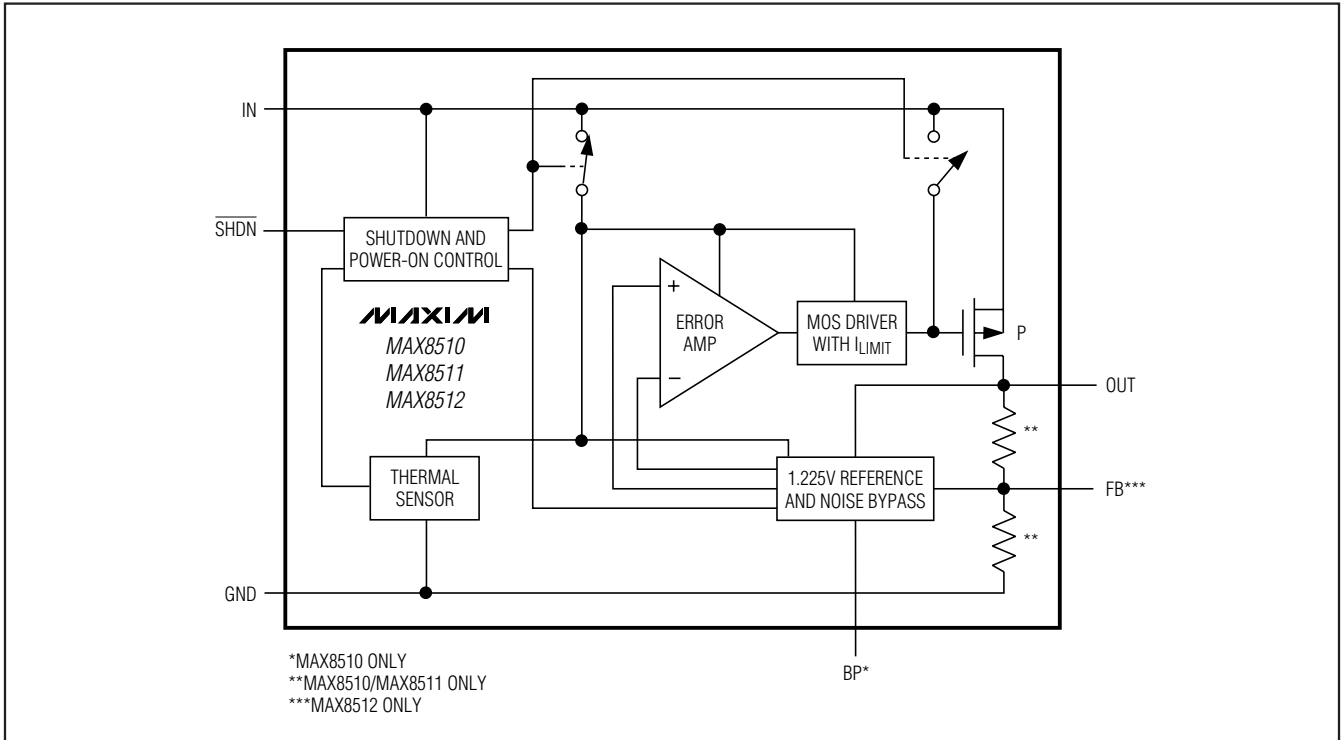



# Ultra-Low-Noise, High PSRR, Low-Dropout, 120mA Linear Regulators

MAX8510/MAX8511/MAX8512

## Ordering Information (continued)

PART*	TEMP RANGE	PIN-PACKAGE
MAX8510EXKxy+T	-40°C to +85°C	5 SC70
MAX8510ETAxy+T	-40°C to +85°C	8 TDFN-EP** 2mm x 2mm
MAX8511EXKxy+T	-40°C to +85°C	5 SC70
MAX8511ETAxy+T	-40°C to +85°C	8 TDFN-EP** 2mm x 2mm
MAX8512EXK+T	-40°C to +85°C	5 SC70
MAX8512ETA+T	-40°C to +85°C	8 TDFN-EP** 2mm x 2mm

\*xy is the output voltage code (see Output Voltage Selector Guide). Other versions between 1.5V and 4.5V are available in 100mV increments. Contact factory for other versions.

\*\*EP = Exposed pad.

+Denotes a lead(Pb)-free/RoHS-compliant package.

T = Tape and reel.

## Typical Operating Circuits (continued)

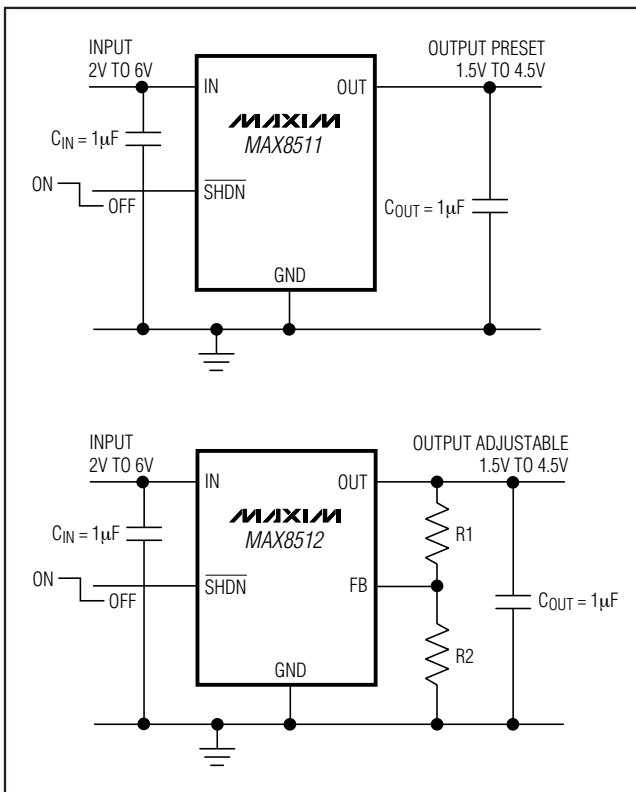

## Output Voltage Selector Guide

PART	V <sub>OUT</sub> (V)	TOP MARK
MAX8510EXK16+T	1.6	AEX
MAX8510EXK18+T	1.8	ATH
MAX8510ETA25+T	2.5	AAO
MAX8510EXK27+T	2.7	ATD
MAX8510ETA28+T	2.8	AAR
MAX8510EXK29+T	2.85	ADS
MAX8510ETA30+T	3	AAS
MAX8510ETA33+T	3.3	AAT
MAX8510ETA45+T	4.5	AAU
MAX8511EXK15+T	1.5	ADU
MAX8511ETA18+T	1.8	AAV
MAX8511ETA25+T	2.5	AAP
MAX8511ETA26+T	2.6	AAW
MAX8511EXK28+T	2.8	AFA
MAX8511ETA29+T	2.85	AAX
MAX8511EXK89+T	2.9	AEH
MAX8511EXK31+T	3.1	ARS
MAX8511ETA33+T	3.3	AAZ
MAX8511EXK45+T	4.5	AEJ
MAX8512ETA+T	Adjustable	AAQ

(Note: Standard output voltage options, shown in **bold**, are available. Contact the factory for other output voltages between 1.5V and 4.5V. Minimum order quantity is 15,000 units.)

## Chip Information

PROCESS: BiCMOS

## Package Information

For the latest package outline information and land patterns (footprints), go to [www.maxim-ic.com/packages](http://www.maxim-ic.com/packages). Note that a "+", "#", or "-" in the package code indicates RoHS status only. Package drawings may show a different suffix character, but the drawing pertains to the package regardless of RoHS status.

PACKAGE TYPE	PACKAGE CODE	OUTLINE NO.	LAND PATTERN NO.
8 TDFN	T822+1	<a href="#">21-0168</a>	<a href="#">90-0064</a>
5 SC70	X5+1	<a href="#">21-0076</a>	<a href="#">90-0188</a>

# **Ultra-Low-Noise, High PSRR, Low-Dropout, 120mA Linear Regulators**

## **Revision History**

<b>REVISION NUMBER</b>	<b>REVISION DATE</b>	<b>DESCRIPTION</b>	<b>PAGES CHANGED</b>
4	8/11	Corrected errors and added lead-free packages	1, 2, 3, 6, 9

*Maxim cannot assume responsibility for use of any circuitry other than circuitry entirely embodied in a Maxim product. No circuit patent licenses are implied. Maxim reserves the right to change the circuitry and specifications without notice at any time. The parametric values (min and max limits) shown in the Electrical Characteristics table are guaranteed. Other parametric values quoted in this data sheet are provided for guidance.*

**10** \_\_\_\_\_ **Maxim Integrated Products, 120 San Gabriel Drive, Sunnyvale, CA 94086 408-737-7600**