



# 1Gbps to 14Gbps, SFP+ Multirate Limiting Amplifier and VCSEL Driver

MAX3799

## General Description

The MAX3799 is a highly integrated limiting amplifier and VCSEL driver that operates up to 14Gbps, making it suitable for Ethernet and Fibre Channel applications. By providing a selectable data path with a noise-shaping filter, the MAX3799 enables a module with 10G optics to be fully compliant with both 1000BASE-SR and 10GBASE-SR specifications. Operating from a single +3.3V supply, this low-power integrated limiting amplifier and VCSEL driver IC enables a platform design for SFP MSA as well as for SFP+ MSA-based optical transceivers. The high-sensitivity limiting amplifier limits the differential input signal generated by a transimpedance amplifier into a CML-level differential output signal. The compact VCSEL driver provides a modulation and a bias current for a VCSEL diode. The optical average power is controlled by an average power control (APC) loop implemented by a controller that interfaces to the VCSEL driver through a 3-wire digital interface. All differential I/Os are optimally back-terminated for a 50Ω transmission line PCB design.

The use of a 3-wire digital interface reduces the pin count while enabling advanced Rx (rate selection, LOS threshold, LOS squelch, LOS polarity, CML output level, signal path polarity, deemphasis, and fast mode-select change time) and Tx settings (modulation current, bias current, polarity, and eye safety control) without the need for external components. The MAX3799 provides multiple current and voltage DACs to allow the use of low-cost controller ICs.

The MAX3799 is packaged in a lead-free, 5mm x 5mm, 32-pin TQFN package.

## Applications

1000BASE-SR/10GBASE-SR Multirate SFP+ Optical Transceiver

1x/2x/4x/8x/16x SFF/SFP/SFP+ MSA Fibre Channel (FC) Optical Transceiver

## Features

- ◆ Enables Single-Module Design Compliance with 1000BASE-SR and 10GBASE-SR Specifications
- ◆ -21.5dBm Optical Sensitivity at 1.25Gbps Using a 10.32Gbps ROSA (-19.7dBm OMA)
- ◆ Low Power Dissipation of 320mW at 3.3V Power Supply
- ◆ Typical Electrical Performance of 14.025Gbps on Rx/Tx (Non-Retimed 16x Fibre Channel Solution)
- ◆ 3mV<sub>p-p</sub> Receiver Sensitivity at 10.32Gbps
- ◆ 4psp-p DJ at Receiver Output at 8.5Gbps 8B/10B
- ◆ 4psp-p DJ at Receiver Output at 10.32Gbps 2<sup>31</sup> - 1 PRBS
- ◆ 26ps Rise and Fall Time at Rx/Tx Output
- ◆ Rate Select for 1Gbps Mode or 10Gbps Mode
- ◆ CML Output Squelch
- ◆ Polarity Select for Rx and Tx
- ◆ LOS Assert Level Adjustment
- ◆ LOS Polarity Select
- ◆ Modulation Current Up to 12mA Into 100Ω Differential Load
- ◆ Bias Current Up to 15mA
- ◆ Integrated Eye Safety Features
- ◆ 3-Wire Digital Interface
- ◆ Programmable Deemphasis at Tx Output

## Ordering Information

PART	TEMP RANGE	PIN-PACKAGE
MAX3799ETJ+	-40°C to +85°C	32 TQFN-EP*

+Denotes a lead(Pb)-free/RoHS-compliant package.

\*EP = Exposed pad.

Typical Application Circuit and Pin Configuration appear at end of data sheet.

# 1Gbps to 14Gbps, SFP+ Multirate Limiting Amplifier and VCSEL Driver

## ABSOLUTE MAXIMUM RATINGS

V <sub>CCR</sub> , V <sub>CCT</sub> , V <sub>CCD</sub> .....	-0.3V to +4.0V	Current Range into FAULT, LOS.....	-1mA to +5mA
Voltage Range at DISABLE, SDA, SCL, CSEL, RSEL, FAULT, BMON, LOS, CAZ2.....	-0.3V to (V <sub>CC</sub> + 0.3V)	Current Range into SDA.....	-1mA to +1mA
Voltage Range at ROUT+, ROUT- .....	(V <sub>CC</sub> - 1V) to (V <sub>CC</sub> + 0.3V)	Current into ROUT+, ROUT- .....	40mA
Voltage at TIN+, TIN-.....	(V <sub>CC</sub> - 2.5V) to (V <sub>CC</sub> - 0.5V)	Current into TOUT+, TOUT- .....	60mA
Voltage Range at TOUT+, TOUT- .....	(V <sub>CC</sub> - 2V) to (V <sub>CC</sub> + 0.3V)	Continuous Power Dissipation (T <sub>A</sub> = +70°C)	
Voltage at BIAS .....	0V to V <sub>CC</sub>	32-Pin TQFN (derate 34.5W/°C above +70°C) .....	2759mW
Voltage at RIN+, RIN-.....	(V <sub>CC</sub> - 2V) to (V <sub>CC</sub> - 0.2V)	Operating Junction Temperature Range .....	-55°C to +150°C
		Storage Temperature Range .....	-65°C to +160°C

Stresses beyond those listed under "Absolute Maximum Ratings" may cause permanent damage to the device. These are stress ratings only, and functional operation of the device at these or any other conditions beyond those indicated in the operational sections of the specifications is not implied. Exposure to absolute maximum rating conditions for extended periods may affect device reliability.

## ELECTRICAL CHARACTERISTICS

(V<sub>CC</sub> = 2.85V to 3.63V, T<sub>A</sub> = -40°C to +85°C, CML receiver output load is AC-coupled to differential 100Ω, C<sub>AZ</sub> = 1nF, transmitter output load is AC-coupled to differential 100Ω (see Figure 1), typical values are at +25°C, V<sub>CC</sub> = 3.3V, I<sub>BIAS</sub> = 6mA, I<sub>MOD</sub> = 6mA, unless otherwise specified. Registers are set to default values unless otherwise noted, and the 3-wire interface is static during measurements. For testing, the RATE\_SEL bit was used and the RSEL pin was left open.)

PARAMETER	SYMBOL	CONDITIONS	MIN	TYP	MAX	UNITS
<b>POWER SUPPLY</b>						
Power-Supply Current	I <sub>CC</sub>	Includes the CML output current; excludes I <sub>BIAS</sub> = 6mA, I <sub>MOD</sub> = 6mA, V <sub>DIFF_ROUT</sub> = 400mV <sub>P-P</sub> (Note 1)		97	150	mA
Power-Supply Voltage	V <sub>CC</sub>		2.85		3.63	V
<b>GENERAL</b>						
Input Data Rate			1.0625		10.32	Gbps
Input/Output SNR			14.1			
BER					10E-12	
<b>POWER-ON RESET</b>						
High POR Threshold				2.55	2.75	V
Low POR Threshold		I <sub>BIAS</sub> = I <sub>BIASOFF</sub> and I <sub>MOD</sub> = I <sub>MODOFF</sub>	2.3	2.45		V
<b>Rx INPUT SPECIFICATIONS</b>						
Differential Input Resistance RIN+/RIN-	RIN_DIFF		75	100	125	Ω
Input Sensitivity (Note 2)	V <sub>INMIN</sub>	RATE_SEL = 0 (1.25Gbps)		1	3	mV <sub>P-P</sub>
		RATE_SEL = 1 (10.32Gbps)		3	8	
Input Overload	V <sub>INMAX</sub>		1.2			V <sub>P-P</sub>
Input Return Loss	SDD11	DUT is powered on, f ≤ 5GHz		14		dB
		DUT is powered on, f ≤ 16GHz		7		
Input Return Loss	SCC11	DUT is powered on, 1GHz < f ≤ 5GHz		8		dB
		DUT is powered on, 1GHz < f ≤ 16GHz		8		
<b>Rx OUTPUT SPECIFICATIONS</b>						
Differential Output Resistance	ROUTDIFF		75	100	125	Ω

# 1Gbps to 14Gbps, SFP+ Multirate Limiting Amplifier and VCSEL Driver

MAX3799

## ELECTRICAL CHARACTERISTICS (continued)

( $V_{CC} = 2.85V$  to  $3.63V$ ,  $T_A = -40^{\circ}C$  to  $+85^{\circ}C$ , CML receiver output load is AC-coupled to differential  $100\Omega$ ,  $C_{AZ} = 1nF$ , transmitter output load is AC-coupled to differential  $100\Omega$  (see Figure 1), typical values are at  $+25^{\circ}C$ ,  $V_{CC} = 3.3V$ ,  $I_{BIAS} = 6mA$ ,  $I_{MOD} = 6mA$ , unless otherwise specified. Registers are set to default values unless otherwise noted, and the 3-wire interface is static during measurements. For testing, the RATE\_SEL bit was used and the RSEL pin was left open.)

PARAMETER	SYMBOL	CONDITIONS	MIN	TYP	MAX	UNITS
Output Return Loss	SDD22	DUT is powered on, $f \leq 5GHz$		11		dB
		DUT is powered on, $f \leq 16GHz$		5		
Output Return Loss	SCC22	DUT is powered on, $1GHz < f \leq 5GHz$		9		dB
		DUT is powered on, $1GHz < f \leq 16GHz$		7		
CML Differential Output Voltage High		$5mV_{P-P} \leq V_{IN} \leq 1200mV_{P-P}$ , SET_CML[162]	595	800	1005	mV <sub>P-P</sub>
CML Differential Output Voltage Medium		$10mV_{P-P} \leq V_{IN} \leq 1200mV_{P-P}$ , SET_CML[80]	300	400	515	mV <sub>P-P</sub>
CML Differential Output DAC Limit		SET_CML[7:0]			215	
Differential Output Signal When Disabled		Outputs AC-coupled, $V_{INMAX}$ applied to input $V_{DIFF\_ROUT} = 800mV_{P-P}$ at 8.5Gbps (Notes 2, 3)		6	15	mV <sub>P-P</sub>
Data Output Transition Time (20% to 80%) (Notes 2, 3, 4)	$t_R/t_F$	$10mV_{P-P} \leq V_{IN} \leq 1200mV_{P-P}$ , RATE_SEL = 1, $V_{DIFF\_ROUT} = 400mV_{P-P}$		26	35	ps
		$5mV_{P-P} \leq V_{IN} \leq 1200mV_{P-P}$ , RATE_SEL = 0, $V_{DIFF\_ROUT} = 800mV_{P-P}$		60	100	
<b>Rx TRANSFER CHARACTERISTICS</b>						
Deterministic Jitter (Notes 2, 3, 5)	DJ	$60mV_{P-P} \leq V_{IN} \leq 400mV_{P-P}$ at 10.32Gbps, RATE_SEL = 1, $V_{DIFF\_ROUT} = 400mV_{P-P}$		4	12	psp-p
		$10mV_{P-P} \leq V_{IN} \leq 1200mV_{P-P}$ at 8.5Gbps, RATE_SEL = 1, $V_{DIFF\_ROUT} = 400mV_{P-P}$		4	12	
		$5mV_{P-P} \leq V_{IN} \leq 1200mV_{P-P}$ at 1.25Gbps, RATE_SEL = 0, $V_{DIFF\_ROUT} = 800mV_{P-P}$		20		
Random Jitter (Notes 2, 3)	RJ	Input = $60mV_{P-P}$ at 1.25Gbps, RATE_SEL = 0, $V_{DIFF\_ROUT} = 800mV_{P-P}$		1.8	2.5	psRMS
		Input = $60mV_{P-P}$ at 8.5Gbps, RATE_SEL = 1, $V_{DIFF\_ROUT} = 400mV_{P-P}$		0.32	0.48	
Low-Frequency Cutoff		$C_{AZ} = 0.1\mu F$		2		kHz
		$C_{AZ} = \text{open}$		500		
<b>Rx LOS SPECIFICATIONS</b>						
LOS Assert Sensitivity Range			14		77	mV <sub>P-P</sub>
LOS Hysteresis		$10 \times \log(V_{DEASSERT}/V_{ASSERT})$ (Note 6)	1.25	2.1		dB
LOS Assert/Deassert Time		(Note 7)	2.3		80	$\mu s$
Low Assert Level		SET_LOS[7] (Notes 2, 6)	8	11	14	mV <sub>P-P</sub>
Low Deassert Level		SET_LOS[7] (Notes 2, 6)	14	18	21	mV <sub>P-P</sub>
Medium Assert Level		SET_LOS[32] (Notes 2, 6)	39	48	58	mV <sub>P-P</sub>
Medium Deassert Level		SET_LOS[32] (Notes 2, 6)	65	81	95	mV <sub>P-P</sub>
High Assert Level		SET_LOS[63] (Notes 2, 6)	77	94	112	mV <sub>P-P</sub>
High Deassert Level		SET_LOS[63] (Notes 2, 6)	127	158	182	mV <sub>P-P</sub>

# 1Gbps to 14Gbps, SFP+ Multirate Limiting Amplifier and VCSEL Driver

## ELECTRICAL CHARACTERISTICS (continued)

( $V_{CC} = 2.85V$  to  $3.63V$ ,  $T_A = -40^{\circ}C$  to  $+85^{\circ}C$ , CML receiver output load is AC-coupled to differential  $100\Omega$ ,  $C_{AZ} = 1nF$ , transmitter output load is AC-coupled to differential  $100\Omega$  (see Figure 1), typical values are at  $+25^{\circ}C$ ,  $V_{CC} = 3.3V$ ,  $I_{BIAS} = 6mA$ ,  $I_{MOD} = 6mA$ , unless otherwise specified. Registers are set to default values unless otherwise noted, and the 3-wire interface is static during measurements. For testing, the RATE\_SEL bit was used and the RSEL pin was left open.)

PARAMETER	SYMBOL	CONDITIONS	MIN	TYP	MAX	UNITS
<b>Tx INPUT SPECIFICATIONS</b>						
Differential Input Voltage	$V_{IN}$	Data rate = 1.0625Gbps	0.2		2.4	$V_{P-P}$
		Data rate = 10.32Gbps	0.075		0.8	
Common-Mode Input Voltage	$V_{INCM}$			2.75		V
Differential Input Resistance	$R_{IN}$		75	100	125	$\Omega$
Input Return Loss	SDD11	DUT is powered on, $f \leq 5GHz$		15		dB
		DUT is powered on, $f \leq 16GHz$		6		
Input Return Loss	SCC11	DUT is powered on, $1GHz < f \leq 5GHz$		9		dB
		DUT is powered on, $1GHz < f \leq 16GHz$		5		
<b>Tx LASER MODULATOR</b>						
Maximum Modulation-On Current into $100\Omega$ Differential Load	$I_{MODMAX}$	Outputs AC-coupled, $V_{CCTO} \geq 2.95V$	12			mA
Minimum Modulation-On Current into $100\Omega$ Differential Load	$I_{MODMIN}$	Outputs AC-coupled			2	mA
Modulation Current DAC Stability		$2mA \leq I_{MOD} \leq 12mA$ (Note 8)			4	%
Modulation Current Rise Time/Fall Time	$t_R/t_F$	$5mA \leq I_{MOD} \leq 10mA$ , 20% to 80%, SET_TXDE[3:0] = 10 (Notes 2, 4)		26	39	ps
Deterministic Jitter (Notes 2, 9)	DJ	$5mA \leq I_{MOD} \leq 12mA$ , at 10.32Gbps, $250mV_{P-P} \leq V_{IN} \leq 800mV_{P-P}$ , SET_TXDE[4:1] = 0		6	12	ps
		$5mA \leq I_{MOD} \leq 12mA$ , at 10.32Gbps, $250mV_{P-P} \leq V_{IN} \leq 800mV_{P-P}$ , SET_TXDE[4:1] = 10		6	13	
		$5mA \leq I_{MOD} \leq 12mA$ , at 8.5Gbps, $250mV_{P-P} \leq V_{IN} \leq 800mV_{P-P}$ , SET_TXDE[4:1] = 0		6	12	
		$5mA \leq I_{MOD} \leq 12mA$ , at 8.5Gbps, $250mV_{P-P} \leq V_{IN} \leq 800mV_{P-P}$ , SET_TXDE[4:1] = 10		6	12	
		$2mA \leq I_{MOD} \leq 12mA$ , at 4.25Gbps		5		
		$2mA \leq I_{MOD} \leq 12mA$ , at 1.0625Gbps		5		
Random Jitter		$5mA \leq I_{MOD} \leq 12mA$ , $250mV_{P-P} \leq V_{IN} \leq 800mV_{P-P}$		0.17	0.5	psRMS
Output Return Loss	SDD22	DUT is powered on, $f \leq 5GHz$		12		dB
		DUT is powered on, $f \leq 16GHz$		5		
<b>Tx BIAS GENERATOR</b>						
Maximum Bias-On Current	$I_{BIASMAX}$	Current into BIAS pin	15			mA
Minimum Bias-On Current	$I_{BIASMIN}$	Current into BIAS pin			2	mA

# 1Gbps to 14Gbps, SFP+ Multirate Limiting Amplifier and VCSEL Driver

MAX3799

## ELECTRICAL CHARACTERISTICS (continued)

( $V_{CC} = 2.85V$  to  $3.63V$ ,  $T_A = -40^{\circ}C$  to  $+85^{\circ}C$ , CML receiver output load is AC-coupled to differential  $100\Omega$ ,  $C_{AZ} = 1nF$ , transmitter output load is AC-coupled to differential  $100\Omega$  (see Figure 1), typical values are at  $+25^{\circ}C$ ,  $V_{CC} = 3.3V$ ,  $I_{BIAS} = 6mA$ ,  $I_{MOD} = 6mA$ , unless otherwise specified. Registers are set to default values unless otherwise noted, and the 3-wire interface is static during measurements. For testing, the RATE\_SEL bit was used and the RSEL pin was left open.)

PARAMETER	SYMBOL	CONDITIONS	MIN	TYP	MAX	UNITS
BIAS Current DAC Stability		$2mA \leq I_{BIAS} \leq 15mA$ (Notes 2, 10)			4	%
Compliance Voltage at BIAS	$V_{BIAS}$		0.9		2.1	V
BIAS Current Monitor Current Gain	$I_{BMON}$	External resistor to GND defines the voltage gain		16		mA/A
Compliance Voltage at BMON	$V_{BMON}$		0		1.8	V
BIAS Current Monitor Current Gain Stability	$I_{BMON}$	$2mA \leq I_{BIAS} \leq 15mA$ (Note 10)			5	%
<b>Tx SAFETY FEATURES</b>						
Excessive Voltage at BMON	$V_{BMON}$	Average voltage, FAULT warning always occurs for $V_{BMON} \geq V_{CC} - 0.55V$ , FAULT warning never occurs for $V_{BMON} \leq V_{CC} - 0.65V$	$V_{CC} - 0.65V$	$V_{CC} - 0.6V$	$V_{CC} - 0.55V$	V
Excessive Voltage at BIAS	$V_{BIAS}$	Average voltage, FAULT always occurs for $V_{BIAS} \leq 0.44V$ , FAULT never occurs for $V_{BIAS} \geq 0.65V$	0.44	0.48	0.65	V
Maximum VCSEL Current in Off State	$I_{OFF}$	FAULT or DISABLE, $V_{BIAS} = V_{CC}$			25	$\mu A$
<b>SFP TIMING REQUIREMENTS</b>						
DISABLE Assert Time	$t_{OFF}$	Time from rising edge of DISABLE input signal to $I_{BIAS} = I_{BIASOFF}$ and $I_{MOD} = I_{MODOFF}$			1	$\mu s$
DISABLE Negate Time	$t_{ON}$	Time from falling edge of DISABLE to $I_{BIAS}$ and $I_{MOD}$ at 90% of steady state when FAULT = 0 before reset			500	$\mu s$
FAULT Reset Time of Power-On Time	$t_{INIT}$	Time from power-on or negation of FAULT using DISABLE			100	ms
FAULT Reset Time	$t_{FAULT}$	Time from fault to FAULT on, $C_{FAULT} \leq 20pF$ , $R_{FAULT} = 4.7k\Omega$			10	$\mu s$
DISABLE to Reset		Time DISABLE must be held high to reset FAULT	5			$\mu s$
<b>OUTPUT_LEVEL VOLTAGE DAC (SET_CML)</b>						
Full-Scale Voltage	$V_{FS}$	$100\Omega$ differential resistive load		1200		mV <sub>P-P</sub>
Resolution				5		mV <sub>P-P</sub>
Integral Nonlinearity	INL	$5mA \leq I_{CML\_LEVEL} \leq 20mA$		$\pm 0.9$		LSB
<b>LOS THRESHOLD VOLTAGE DAC (SET_LOS)</b>						
Full-Scale Voltage	$V_{FS}$			94		mV <sub>P-P</sub>
Resolution				1.5		mV <sub>P-P</sub>
Integral Nonlinearity	INL	$11mV_{P-P} \leq V_{TH\_LOS} \leq 94mV_{P-P}$		$\pm 0.7$		LSB
<b>BIAS CURRENT DAC (SET_IBIAS)</b>						
Full-Scale Current	$I_{FS}$			21		mA

# 1Gbps to 14Gbps, SFP+ Multirate Limiting Amplifier and VCSEL Driver

## ELECTRICAL CHARACTERISTICS (continued)

( $V_{CC} = 2.85V$  to  $3.63V$ ,  $T_A = -40^{\circ}C$  to  $+85^{\circ}C$ , CML receiver output load is AC-coupled to differential  $100\Omega$ ,  $C_{AZ} = 1nF$ , transmitter output load is AC-coupled to differential  $100\Omega$  (see Figure 1), typical values are at  $+25^{\circ}C$ ,  $V_{CC} = 3.3V$ ,  $I_{BIAS} = 6mA$ ,  $I_{MOD} = 6mA$ , unless otherwise specified. Registers are set to default values unless otherwise noted, and the 3-wire interface is static during measurements. For testing, the RATE\_SEL bit was used and the RSEL pin was left open.)

PARAMETER	SYMBOL	CONDITIONS	MIN	TYP	MAX	UNITS
Resolution				40		$\mu A$
Integral Nonlinearity	INL	$1mA \leq I_{BIAS} \leq 15mA$		$\pm 1$		LSB
Differential Nonlinearity	DNL	$1mA \leq I_{BIAS} \leq 15mA$ , guaranteed monotonic at 8-bit resolution (SET_IBIAS[8:1])		$\pm 1$		LSB
<b>MODULATION CURRENT DAC (SET_IMOD)</b>						
Full-Scale Current	I <sub>FS</sub>			21		mA
Resolution				40		$\mu A$
Integral Nonlinearity	INL	$2mA \leq I_{MOD} \leq 12mA$		$\pm 1$		LSB
Differential Nonlinearity	DNL	$2mA \leq I_{MOD} \leq 12mA$ , guaranteed monotonic at 8-bit resolution (SET_IMOD[8:1])		$\pm 1$		LSB
<b>CONTROL I/O SPECIFICATIONS</b>						
RSEL Input Current	I <sub>IH</sub> , I <sub>IL</sub>				150	$\mu A$
RSEL Input High Voltage	V <sub>IH</sub>		1.8		V <sub>CC</sub>	V
RSEL Input Low Voltage	V <sub>IL</sub>		0		0.8	V
RSEL Input Impedance	R <sub>PULL</sub>	Internal pulldown resistor	40	75	110	k $\Omega$
DISABLE Input Current	I <sub>IH</sub>				12	$\mu A$
	I <sub>IL</sub>	Dependency on pullup resistance		420	800	
DISABLE Input High Voltage	V <sub>IH</sub>		1.8		V <sub>CC</sub>	V
DISABLE Input Low Voltage	V <sub>IL</sub>		0		0.8	V
DISABLE Input Impedance	R <sub>PULL</sub>	Internal pullup resistor	4.7	8	10	k $\Omega$
LOS, FAULT Output High Voltage	V <sub>OH</sub>	R <sub>LOS</sub> = 4.7k $\Omega$ - 10k $\Omega$ to V <sub>CC</sub> , R <sub>FAULT</sub> = 4.7k $\Omega$ - 10k $\Omega$ to V <sub>CC</sub>	V <sub>CC</sub> - 0.5		V <sub>CC</sub>	V
LOS, FAULT Output Low Voltage	V <sub>OL</sub>	R <sub>LOS</sub> = 4.7k $\Omega$ - 10k $\Omega$ to V <sub>CC</sub> , R <sub>FAULT</sub> = 4.7k $\Omega$ - 10k $\Omega$ to V <sub>CC</sub>	0		0.4	V
<b>3-WIRE DIGITAL I/O SPECIFICATIONS (SDA, CSEL, SCL)</b>						
Input High Voltage	V <sub>IH</sub>		2.0		V <sub>CC</sub>	V
Input Low Voltage	V <sub>IL</sub>				0.8	V
Input Hysteresis	V <sub>HYST</sub>			0.082		V
Input Leakage Current	I <sub>IL</sub> , I <sub>IH</sub>	V <sub>IN</sub> = 0V or V <sub>CC</sub> ; internal pullup or pulldown (75k $\Omega$ typ)			150	$\mu A$
Output High Voltage	V <sub>OH</sub>	External pullup of 4.7k $\Omega$ to V <sub>CC</sub>	V <sub>CC</sub> - 0.5			V
Output Low Voltage	V <sub>OL</sub>	External pullup of 4.7k $\Omega$ to V <sub>CC</sub>			0.4	V
<b>3-WIRE DIGITAL INTERFACE TIMING CHARACTERISTICS (See Figure 4)</b>						
SCL Clock Frequency	f <sub>SCL</sub>			400	1000	kHz
SCL Pulse-Width High	t <sub>CH</sub>		0.5			$\mu s$
SCL Pulse-Width Low	t <sub>CL</sub>		0.5			$\mu s$

# 1Gbps to 14Gbps, SFP+ Multirate Limiting Amplifier and VCSEL Driver

MAX3799

## ELECTRICAL CHARACTERISTICS (continued)

( $V_{CC} = 2.85V$  to  $3.63V$ ,  $T_A = -40^{\circ}C$  to  $+85^{\circ}C$ , CML receiver output load is AC-coupled to differential  $100\Omega$ ,  $C_{AZ} = 1nF$ , transmitter output load is AC-coupled to differential  $100\Omega$  (see Figure 1), typical values are at  $+25^{\circ}C$ ,  $V_{CC} = 3.3V$ ,  $I_{BIAS} = 6mA$ ,  $I_{MOD} = 6mA$ , unless otherwise specified. Registers are set to default values unless otherwise noted, and the 3-wire interface is static during measurements. For testing, the RATE\_SEL bit was used and the RSEL pin was left open.)

PARAMETER	SYMBOL	CONDITIONS	MIN	TYP	MAX	UNITS
SDA Setup Time	$t_{DS}$			100		ns
SDA Hold Time	$t_{DH}$			100		ns
SCL Rise to SDA Propagation Time	$t_D$			5		ns
CSEL Pulse-Width Low	$t_{CSW}$		500			ns
CSEL Leading Time Before the First SCL Edge	$t_L$			500		ns
CSEL Trailing Time After the Last SCL Edge	$t_T$			500		ns
SDA, SCL External Load	$C_B$	Total bus capacitance on one line with $4.7k\Omega$ pullup to $V_{CC}$			20	pF

**Note 1:** Supply current is measured with unterminated receiver CML output or with AC-coupled Rx output termination. The Tx output and the bias current output must be connected to a separate supply to remove the modulation/bias current portion from the supply current. BIAS must be connected to 2.0V. TOUT+/- must be connected through  $50\Omega$  load resistors to a separate supply voltage.

**Note 2:** Guaranteed by design and characterization,  $T_A = -40^{\circ}C$  to  $+95^{\circ}C$ .

**Note 3:** The data input transition time is controlled by a 4th-order Bessel filter with  $-3dB$  frequency =  $0.75 \times$  data rate. The deterministic jitter caused by this filter is not included in the DJ generation specifications.

**Note 4:** Test pattern is 00001111 at 1.25Gbps for RATE\_SEL = 0. Test pattern is 00001111 at 8.5Gbps for RATE\_SEL = 1.

**Note 5:** Receiver deterministic jitter is measured with a repeating  $2^{31} - 1$  PRBS equivalent pattern at 10.32Gbps. For 1.25Gbps to 8.5Gbps, a repeating K28.5 pattern [00111110101100000101] is used. Deterministic jitter is defined as the arithmetic sum of pulse-width distortion (PWD) and pattern-dependent jitter (PDJ).

**Note 6:** Measured with a k28.5 pattern from 1.0625Gbps to 8.5Gbps. Measured with  $2^{31} - 1$  PRBS at 10.32Gbps.

**Note 7:** Measurement includes an input AC-coupling capacitor of 100nF and  $C_{CAZ}$  of 100nF. The signal at the input is switched between two amplitudes: Signal\_ON and Signal\_OFF.

1) Receiver operates at sensitivity level plus 1dB power penalty.

a) Signal\_OFF = 0

Signal\_ON = (+8dB) +  $10\log(\text{min\_assert\_level})$

b) Signal\_ON = (+1dB) +  $10\log(\text{max\_deassert\_level})$

Signal\_OFF = 0

2) Receiver operates at overload.

Signal\_OFF = 0

Signal\_ON = 1.2V<sub>P-P</sub>

max\_deassert\_level and the min\_assert\_level are measured for one LOS\_THRESHOLD setting.

**Note 8:** Gain stability is defined as  $[(I_{\text{measured}}) - (I_{\text{reference}})] / (I_{\text{reference}})$  over the listed current range, temperature, and  $V_{CC}$  from +2.95V to +3.63V. Reference current measured at  $V_{CC} = +3.2V$ ,  $T_A = +25^{\circ}C$ .

**Note 9:** Transmitter deterministic jitter is measured with a repeating  $2^7 - 1$  PRBS, 72 0s,  $2^7 - 1$  PRBS, and 72 1s pattern at 10.32Gbps. For 1.0625Gbps to 8.5Gbps, a repeating K28.5 pattern [00111110101100000101] is used. Deterministic jitter is defined as the arithmetic sum of PWD and PDJ.

**Note 10:** Gain stability is defined as  $[(I_{\text{measured}}) - (I_{\text{reference}})] / (I_{\text{reference}})$  over the listed current range, temperature, and  $V_{CC}$  from +2.85V to +3.63V. Reference current measured at  $V_{CC} = +3.3V$ ,  $T_A = +25^{\circ}C$ .

# 1Gbps to 14Gbps, SFP+ Multirate Limiting Amplifier and VCSEL Driver

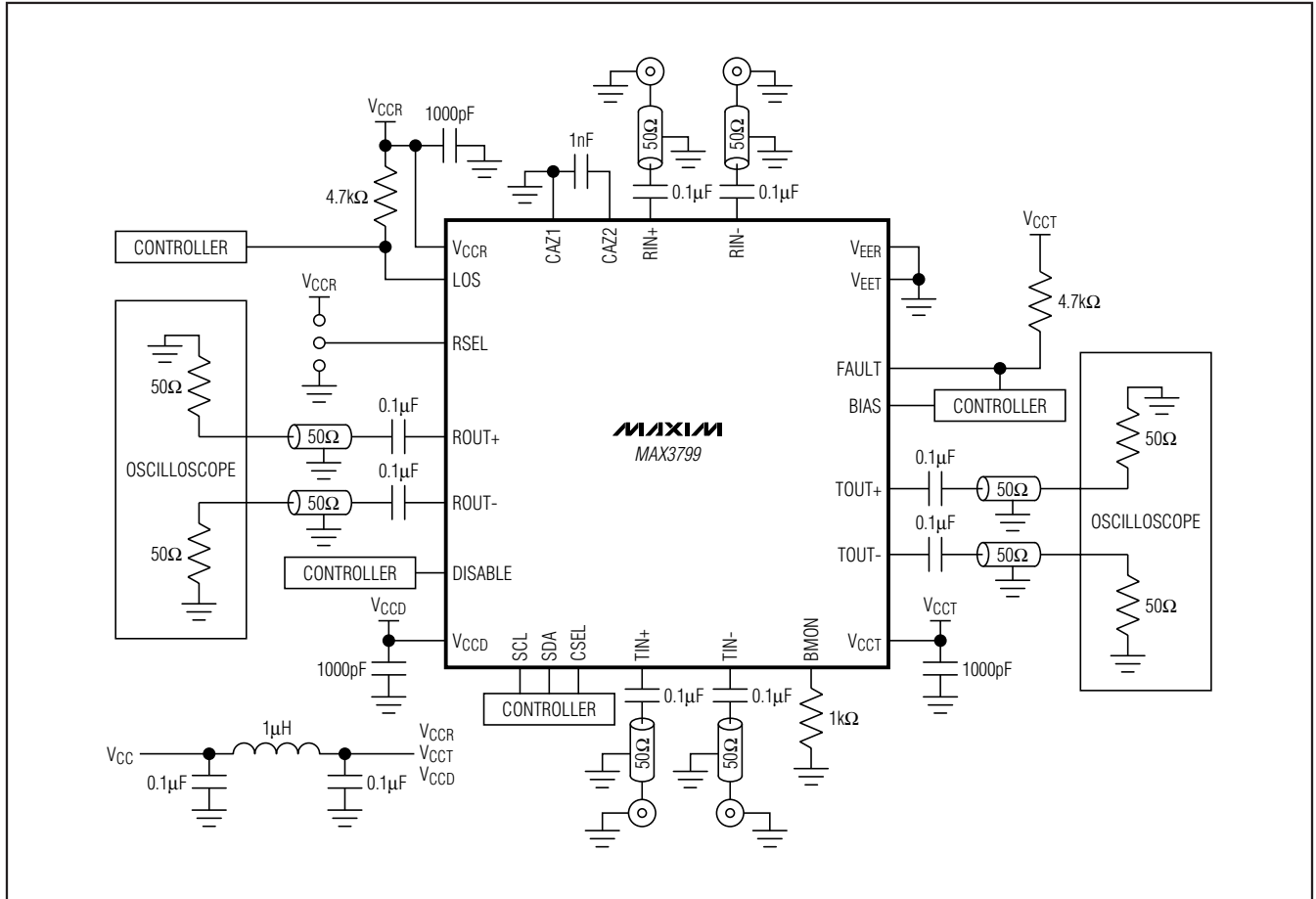

Figure 1. Test Circuit for VCSEL Driver Characterization



# 1Gbps to 14Gbps, SFP+ Multirate Limiting Amplifier and VCSEL Driver

MAX3799

## Typical Operating Characteristics—Limiting Amplifier

( $V_{CC} = 3.3V$ ,  $T_A = +25^\circ C$ , unless otherwise specified. Figure 1 shows the typical setup used for measurements. Registers are set to default values unless otherwise noted, and the 3-wire interface is static during measurements. For testing, the RATE\_SEL bit was used and the RSEL pin was left open.)

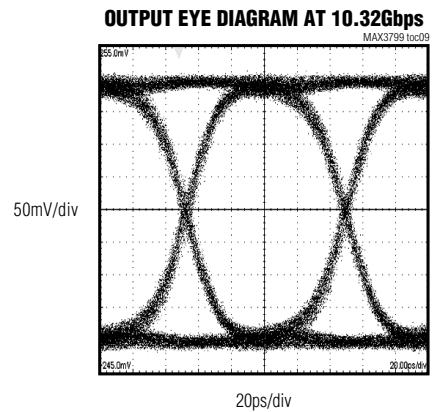
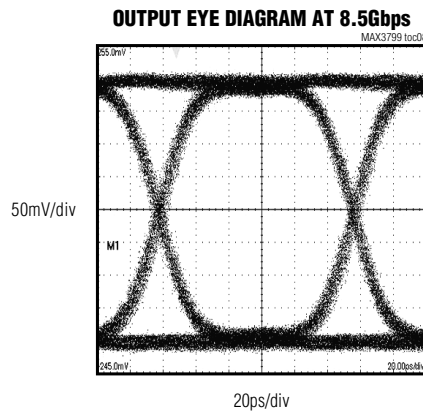
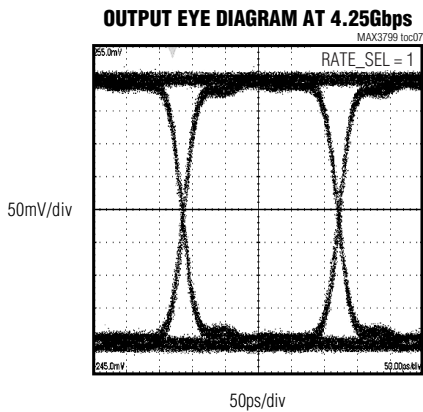
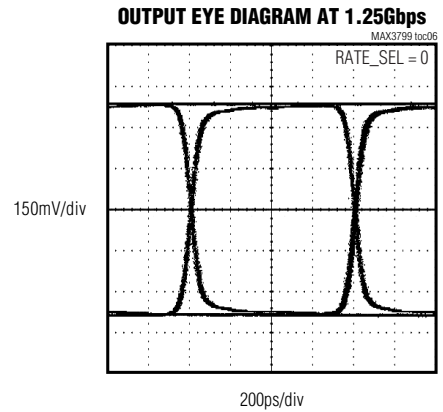
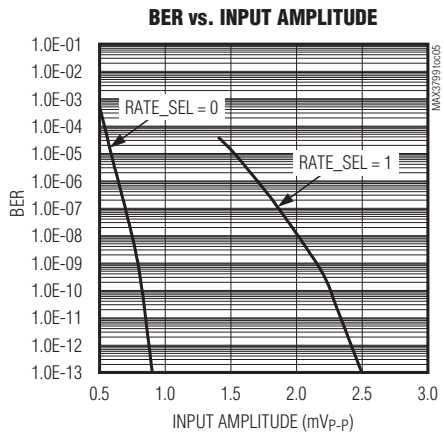
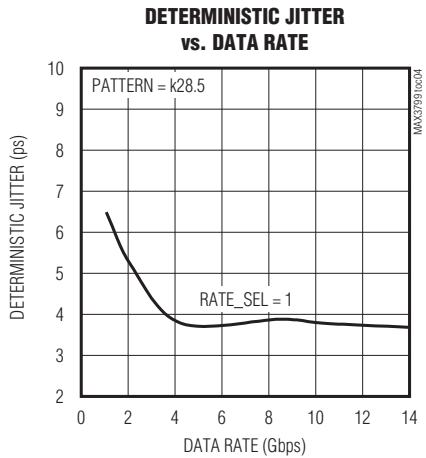
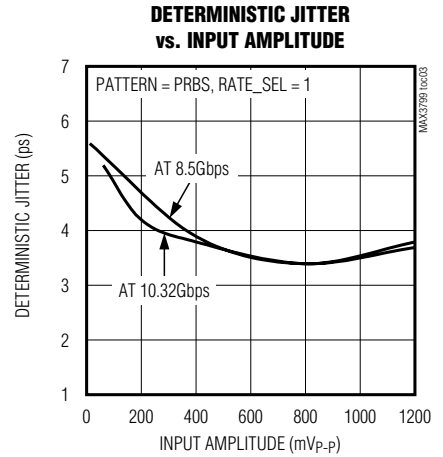
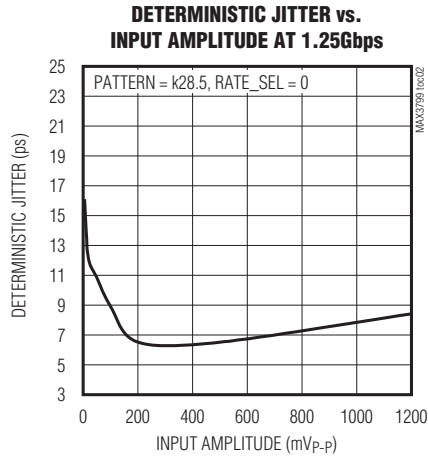
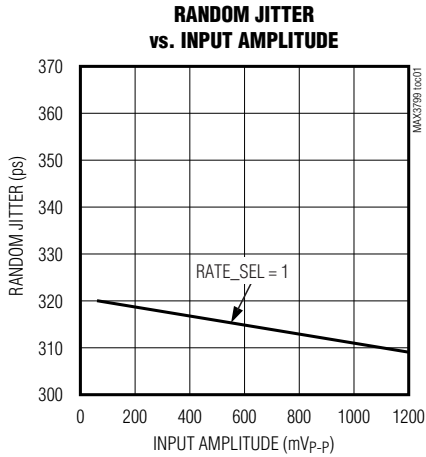

# 1Gbps to 14Gbps, SFP+ Multirate Limiting Amplifier and VCSEL Driver

## Typical Operating Characteristics—Limiting Amplifier (continued)

( $V_{CC} = 3.3V$ ,  $T_A = +25^\circ C$ , unless otherwise specified. Figure 1 shows the typical setup used for measurements. Registers are set to default values unless otherwise noted, and the 3-wire interface is static during measurements. For testing, the RATE\_SEL bit was used and the RSEL pin was left open.)

**OUTPUT EYE DIAGRAM AT 14.025Gbps**

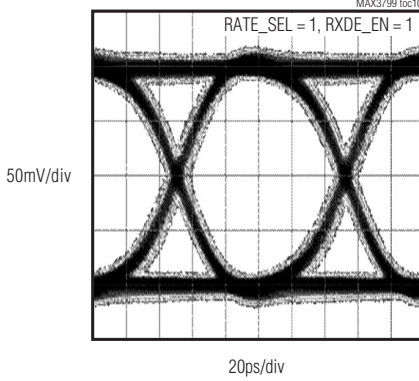

**TRANSITION TIME vs. INPUT AMPLITUDE**

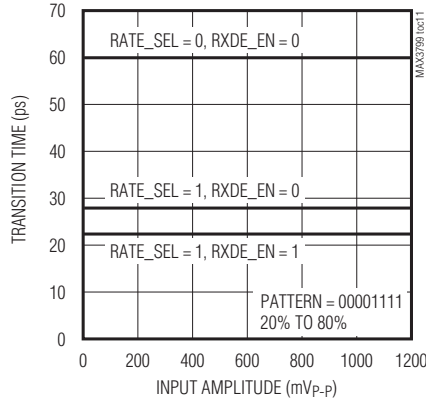

**LOS THRESHOLD vs. DAC SETTING**

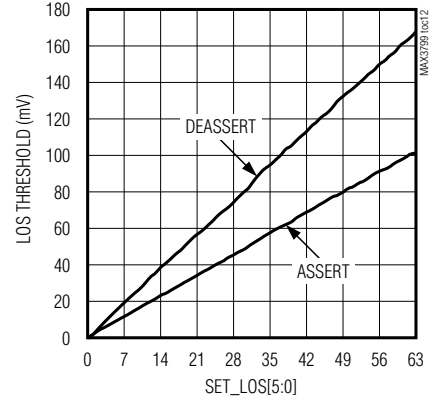

**SENSITIVITY vs. DATA RATE**

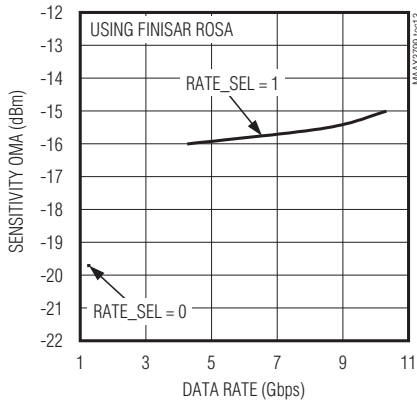

**Rx INPUT RETURN LOSS**

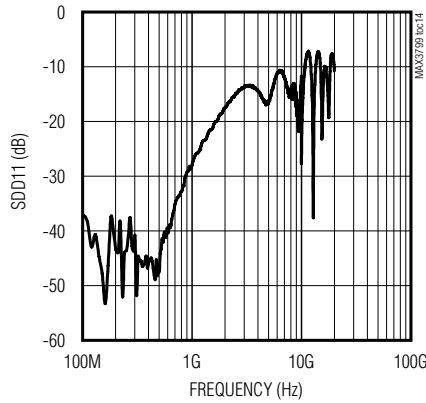

**Rx OUTPUT RETURN LOSS**

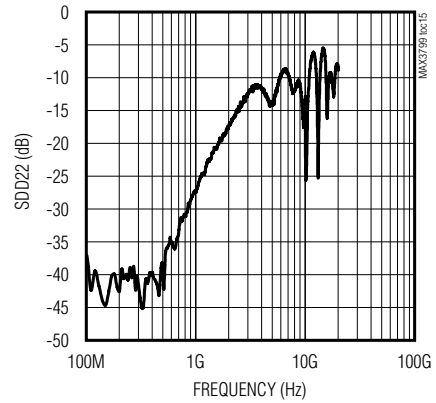

**CML OUTPUT AMPLITUDE vs. DAC SETTING**

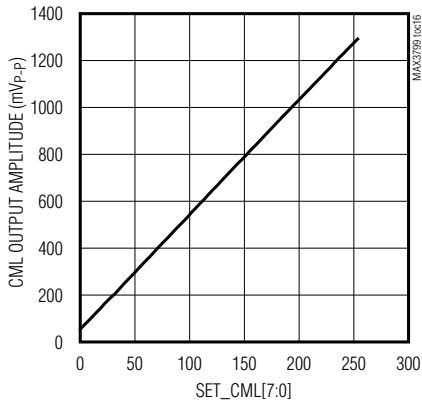

**TOTAL SUPPLY CURRENT vs. TEMPERATURE**

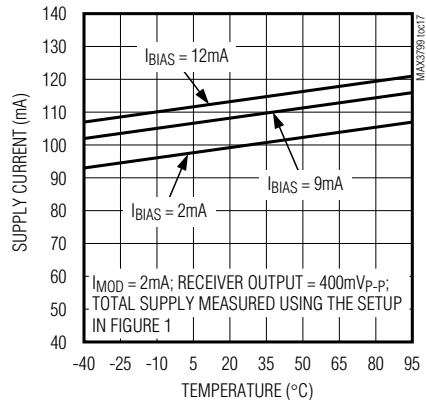

**TOTAL SUPPLY CURRENT vs. TEMPERATURE**

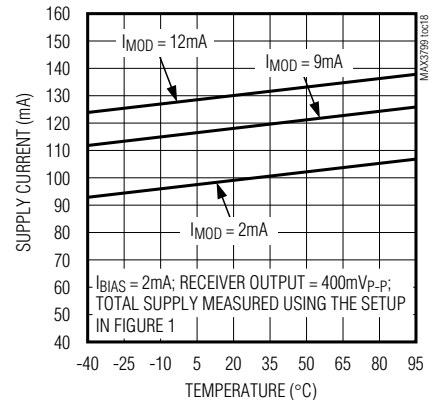

# 1Gbps to 14Gbps, SFP+ Multirate Limiting Amplifier and VCSEL Driver

MAX3799

## Typical Operating Characteristics—Limiting Amplifier (continued)

( $V_{CC} = 3.3V$ ,  $T_A = +25^\circ C$ , unless otherwise specified. Figure 1 shows the typical setup used for measurements. Registers are set to default values unless otherwise noted, and the 3-wire interface is static during measurements. For testing, the RATE\_SEL bit was used and the RSEL pin was left open.)

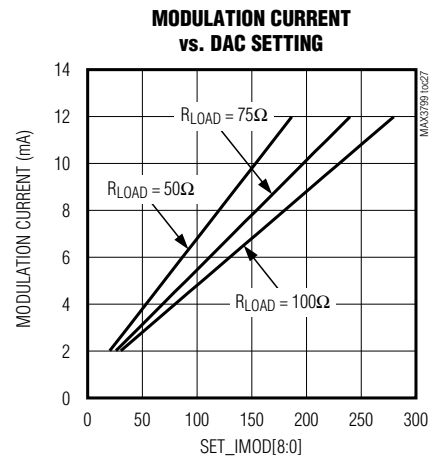
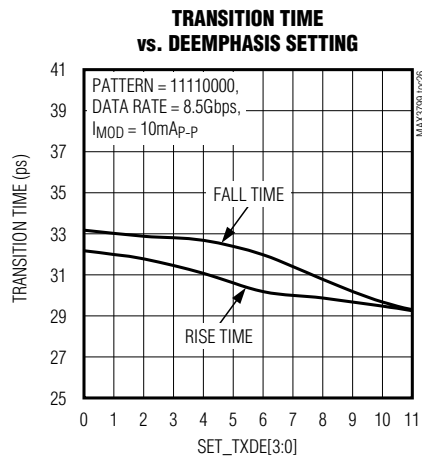
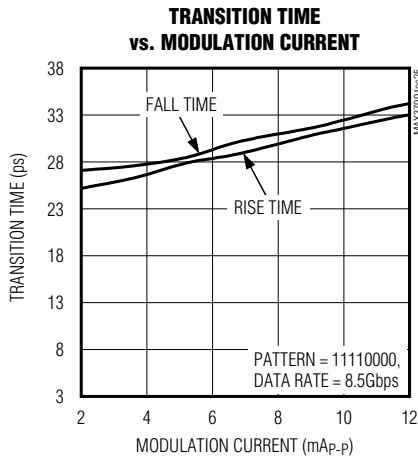
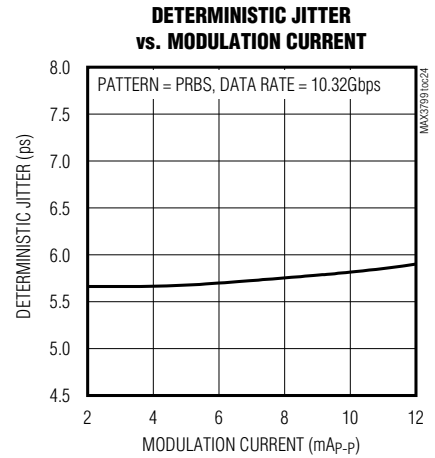
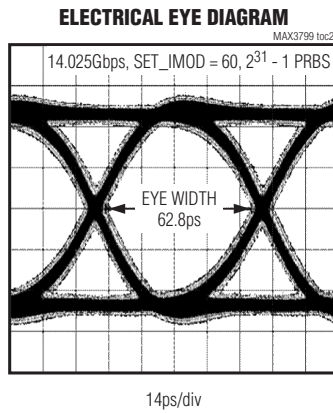
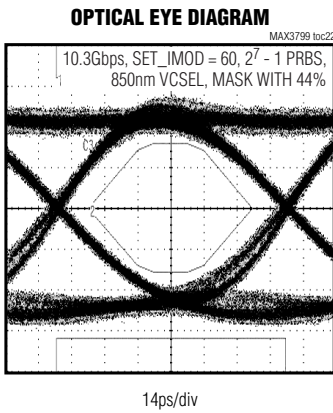
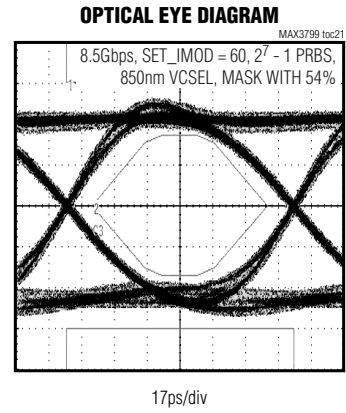
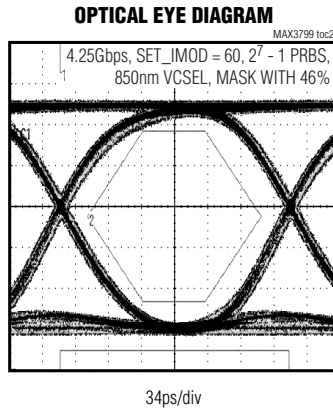
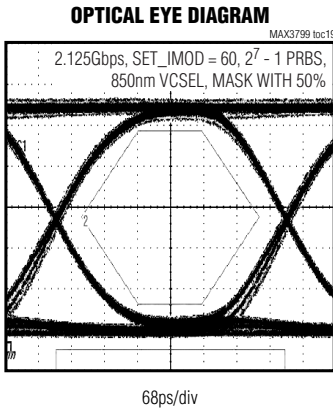

# 1Gbps to 14Gbps, SFP+ Multirate Limiting Amplifier and VCSEL Driver

## Typical Operating Characteristics—Limiting Amplifier (continued)

( $V_{CC} = 3.3V$ ,  $T_A = +25^\circ C$ , unless otherwise specified. Figure 1 shows the typical setup used for measurements. Registers are set to default values unless otherwise noted, and the 3-wire interface is static during measurements. For testing, the RATE\_SEL bit was used and the RSEL pin was left open.)

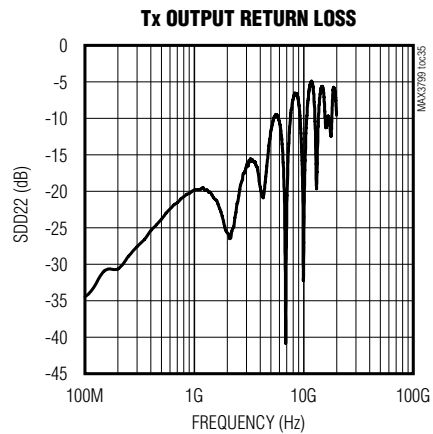
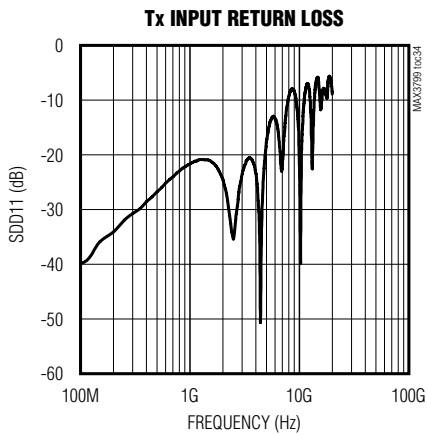
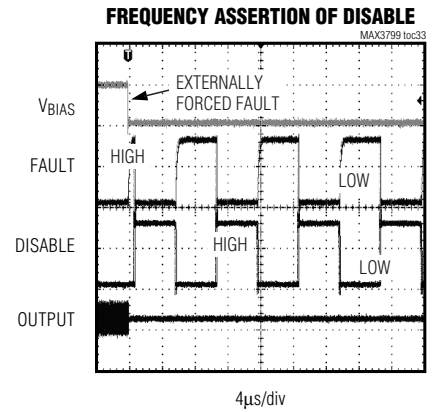
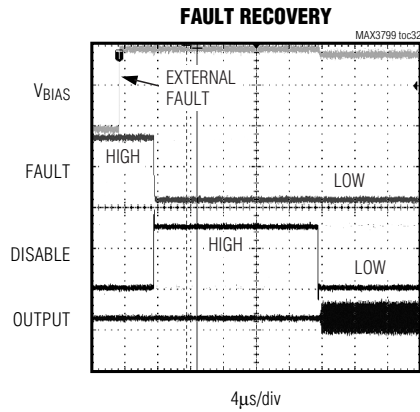
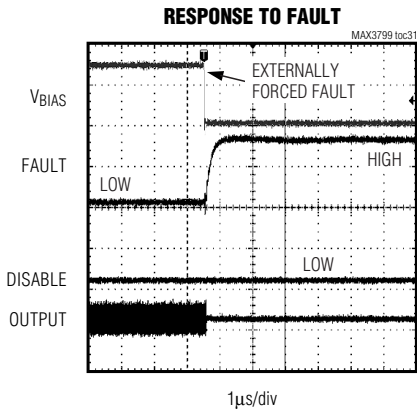
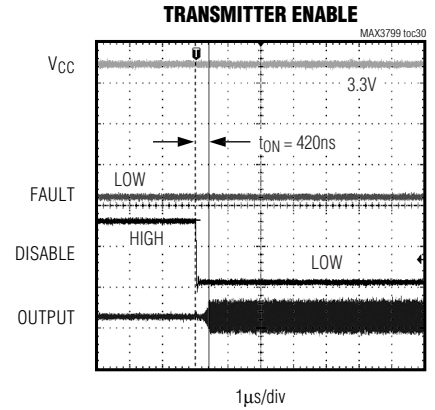
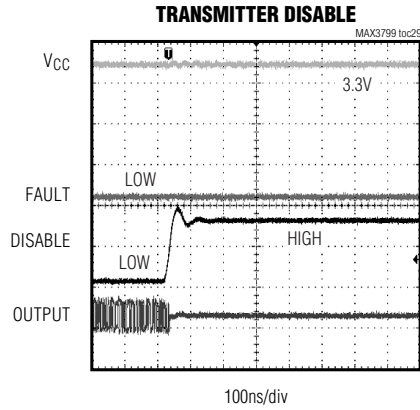
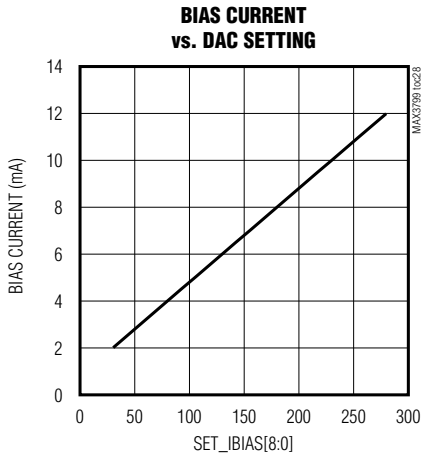

# 1Gbps to 14Gbps, SFP+ Multirate Limiting Amplifier and VCSEL Driver

MAX3799

## Typical Operating Characteristics—Limiting Amplifier (continued)

( $V_{CC} = 3.3V$ ,  $T_A = +25^\circ C$ , unless otherwise specified. Figure 1 shows the typical setup used for measurements. Registers are set to default values unless otherwise noted, and the 3-wire interface is static during measurements. For testing, the RATE\_SEL bit was used and the RSEL pin was left open.)

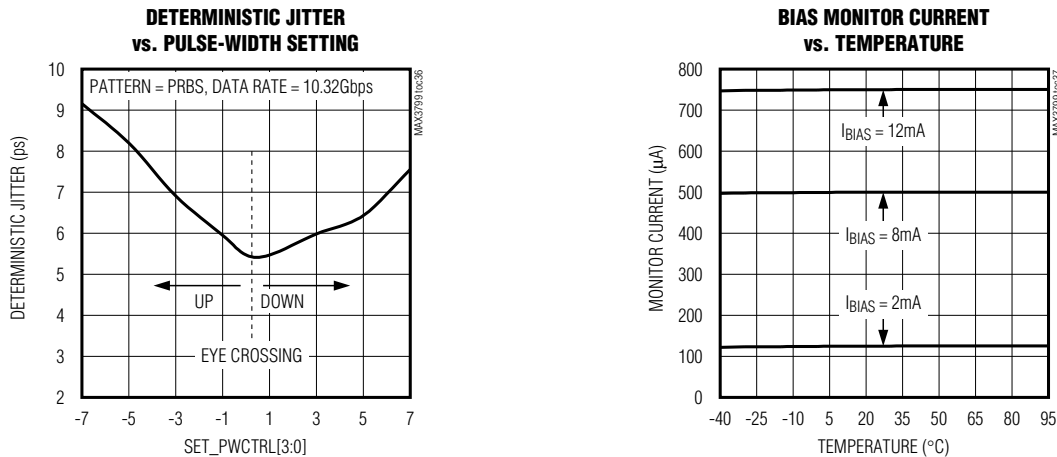

## Pin Description

PIN	NAME	FUNCTION
1	LOS	Loss-of-Signal Output, Open Drain. The default polarity of LOS is high when the level of the input signal is below the preset threshold set by the SET_LOS DAC. Polarity of the LOS function can be inverted by setting LOS_POL = 0. The LOS circuitry can be disabled by setting the bit LOS_EN = 0.
2	RSEL	Mode-Select Input, TTL/CMOS. Set the RSEL pin or RATE_SEL bit (set by the 3-wire digital interface) to logic-high for high-bandwidth mode. Setting RSEL and RATE_SEL logic-low for high-gain mode. The RSEL pin is internally pulled down by a 75k $\Omega$ resistor to ground.
3, 6, 27, 30	VCCR	Power Supply. Provides supply voltage to the receiver block.
4	ROUT+	Noninverted Receive Data Output, CML. Back-terminated for 50 $\Omega$ load.
5	ROUT-	Inverted Receive Data Output, CML. Back-terminated for 50 $\Omega$ load.
7	VCCD	Power Supply. Provides supply voltage for the digital block.
8	DISABLE	Transmitter Disable Input, TTL/CMOS. Set to logic-low for normal operation. Logic-high or open disables both the modulation and bias current. Internally pulled up by an 8k $\Omega$ resistor to V <sub>CC</sub> .
9	SCL	Serial-Clock Input, TTL/CMOS. This pin has a 75k $\Omega$ internal pulldown.
10	SDA	Serial-Data Bidirectional Input, TTL/CMOS. Open-drain output. This pin has a 75k $\Omega$ internal pullup, but it requires an external 4.7k $\Omega$ pullup resistor to meet the 3-wire digital timing specification. (Data line collision protection is implemented.)
11	CSEL	Chip-Select Input, TTL/CMOS. Setting CSEL to logic-high starts a cycle. Setting CSEL to logic-low ends the cycle and resets the control state machine. Internally pulled down by a 75k $\Omega$ resistor to ground.
12, 15, 18, 21, 24, 25	VCC <sub>T</sub>	Power Supply. Provides supply voltage to the transmitter block.
13	TIN+	Noninverted Transmit Data Input, CML

# 1Gbps to 14Gbps, SFP+ Multirate Limiting Amplifier and VCSEL Driver

## Pin Description (continued)

PIN	NAME	FUNCTION
14	TIN-	Inverted Transmit Data Input, CML
16	BMON	Bias Current Monitor Output. Current out of this pin develops a ground-referenced voltage across an external resistor that is proportional to the laser bias current.
17	VEET	Ground. Provides ground for the transmitter block.
19	TOUT-	Inverted Modulation Current Output. Back-termination of 50Ω to V <sub>CC</sub> T.
20	TOUT+	Noninverted Modulation Current Output. Back-termination of 50Ω to V <sub>CC</sub> T.
22	BIAS	VCSEL Bias Current Output
23	FAULT	Transmitter Fault Output, Open Drain. Logic-high indicates a fault condition. FAULT remains high even after the fault condition has been removed. A logic-low occurs when the fault condition has been removed and the fault latch has been cleared by the DISABLE signal.
26	VEER	Ground. Provides ground for the receiver block.
28	RIN-	Inverted Receive Data Input, CML
29	RIN+	Noninverted Receive Data Input, CML
31	CAZ2	Offset Correction Loop Capacitor. A capacitor connected between this pin and CAZ1 sets the time constant of the offset correction loop. The offset correction can be disabled through the digital interface by setting the bit AZ_EN = 0.
32	CAZ1	Offset Correction Loop Capacitor. Counterpart to CAZ2, internally connected to VEER.
—	EP	Exposed Pad. Ground. Must be soldered to circuit board ground for proper thermal and electrical performance (see the <i>Exposed-Pad Package</i> section).

### Detailed Description

The MAX3799 SFP+ transceiver combines a limiting amplifier receiver with loss-of-signal detection and a VCSEL laser driver transmitter with fault protection. Configuration of the advanced Rx and Tx settings of the MAX3799 is performed by a controller through the 3-wire interface. The MAX3799 provides multiple current and voltage DACs to allow the use of low-cost controller ICs.

### Limiting Amplifier Receiver

The limiting amplifier receiver inside the MAX3799 is designed to operate from 1.0625Gbps to 10.32Gbps. The receiver includes a dual path limiter, offset correction circuitry, CML output stage with deemphasis, and loss-of-signal circuitry. The functions of the receiver can be controlled through the on-chip 3-wire interface. The registers that control the receiver functionality are RXCTRL1, RXCTRL2, RXSTAT, MODECTRL, SET\_CML, and SET\_LOS.

# 1Gbps to 14Gbps, SFP+ Multirate Limiting Amplifier and VCSEL Driver

MAX3799

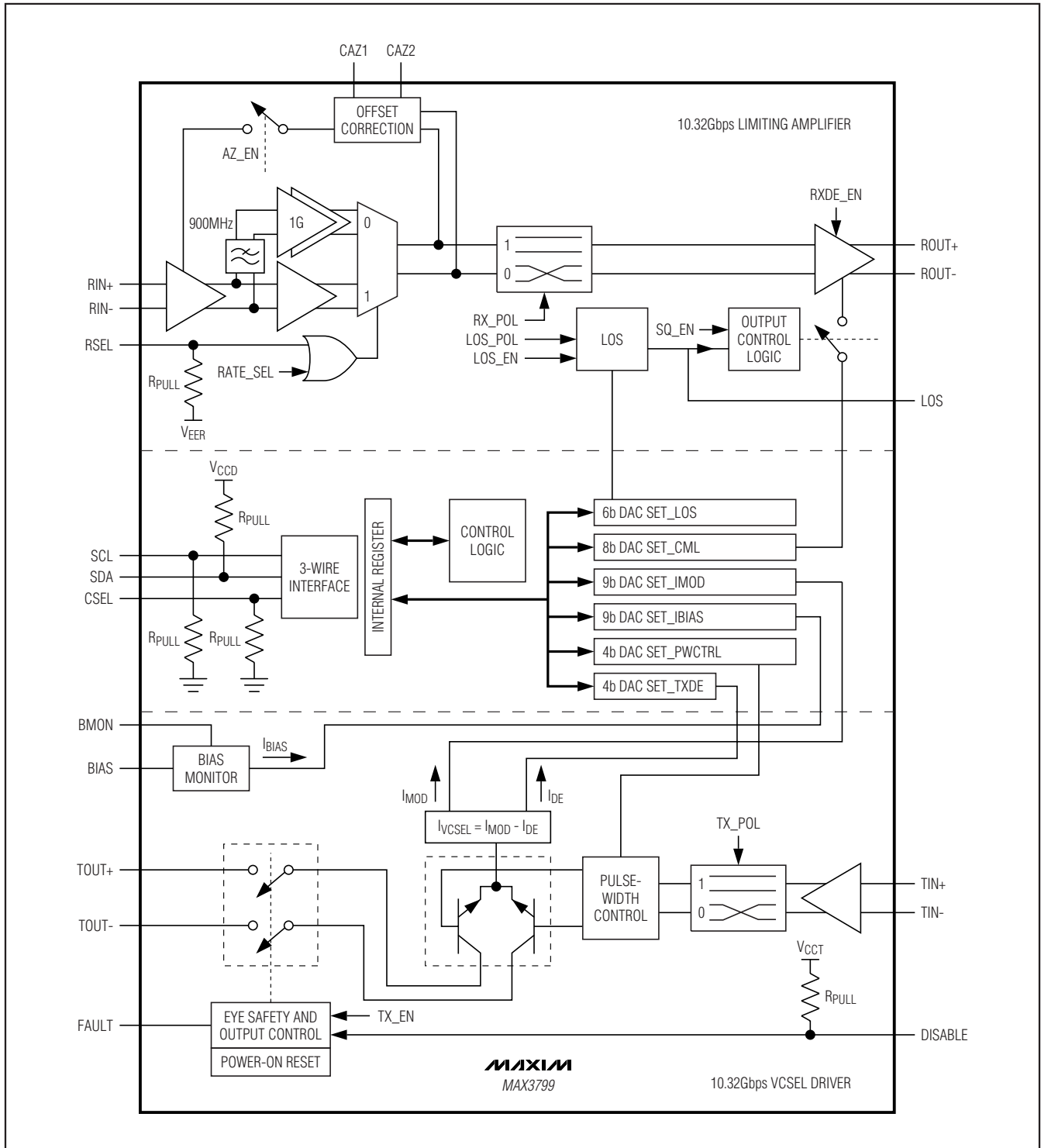

Figure 2. Functional Diagram



# 1Gbps to 14Gbps, SFP+ Multirate Limiting Amplifier and VCSEL Driver

## Dual Path Limiter

The limiting amplifier features a low data-rate mode (1.25Gbps) and a high data-rate mode (up to 10.32Gbps), allowing for overall system optimization. Either the RSEL pin or the RATE\_SEL bit can perform the rate selection. For operating up to 1.25Gbps, the low data-rate mode (RATE\_SEL = 0) is recommended. For operation up to 14.025Gbps, the high data-rate mode (RATE\_SEL = 1) is recommended. The polarity of the ROUT+/ROUT- relative to RIN+/RIN- is programmed by the RX\_POL bit.

## Offset Correction Circuitry

The offset correction circuit is enabled to remove pulse-width distortion caused by intrinsic offset voltages within the differential amplifier stages. An external capacitor (CAZ) connected between the CAZ1 and CAZ2 pins is used to set the offset correction loop cutoff frequency. The offset loop can be disabled using the AZ\_EN bit.

## CML Output Stage with Deemphasis and Slew-Rate Control

The CML output stage is optimized for differential 100Ω loads. The RXDE\_EN bit adds analog deemphasis compensation to the limited differential output signal for SFP connector losses. The output stage is controlled by a combination of the RX\_EN and SQ\_EN bits and the LOS pin. See Table 1.

Amplitude of the CML output stage is controlled by an 8-bit DAC register (SET\_CML). The differential output amplitude range is from 40mV<sub>P-P</sub> up to 1200mV<sub>P-P</sub> with 4.6mV<sub>P-P</sub> resolution (assuming an ideal 100Ω differential load).

**Table 1. CML Output Stage Operation Mode**

RX_EN	SQ_EN	LOS	OPERATION MODE DESCRIPTION
0	X	X	CML output disabled.
1	0	X	CML output enabled.
1	1	0	CML output enabled.
1	1	1	CML output disabled.

## Loss-of-Signal (LOS) Circuitry

The input data amplitude is compared to a preset threshold controlled by the 6-bit DAC register SET\_LOS. The LOS assert level can be programmed from 14mV<sub>P-P</sub> up to 77mV<sub>P-P</sub> with 1.5mV<sub>P-P</sub> resolution (assuming an ideal 100Ω differential source). LOS is enabled through the LOS\_EN bit and the polarity of the LOS is controlled with the LOS\_POL bit.

## VCSEL Driver

The VCSEL driver inside the MAX3799 is designed to operate from 1.0625Gbps to 10.32Gbps. The transmitter contains a differential data path with pulse-width adjustment, bias current and modulation current DACs, output driver with programmable deemphasis, power-on reset circuitry, BIAS monitor, VCSEL current limiter, and eye safety circuitry. A 3-wire digital interface is used to control the transmitter functions. The registers that control the transmitter functionality are TXCTRL, TXSTAT1, TXSTAT2, SET\_IBIAS, SET\_IMOD, IMOD-MAX, IBIASMAX, MODINC, BIASINC, MODECTRL, SET\_PWCTRL, and SET\_TXDE.

## Differential Data Path

The CML input buffer is optimized for AC-coupled signals and is internally terminated with a differential 100Ω. Differential input data is equalized for high-frequency losses due to SFP connectors. The TX\_POL bit in the TXCTRL register controls the polarity of TOUT+ and TOUT- vs. TIN+ and TIN-. The SET\_PWCTRL register controls the output eye-crossing adjustment. A status indicator bit (TXED) monitors the presence of an AC input signal.

**Table 2. Slew-Rate Control for CML Output Stage**

RATE_SEL	OPERATION MODE DESCRIPTION
0	1.25Gbps operation with reduced output edge speed.
1	Up to 10.32Gbps operation.



# 1Gbps to 14Gbps, SFP+ Multirate Limiting Amplifier and VCSEL Driver

MAX3799

## **Bias Current DAC**

The bias current from the MAX3799 is optimized to provide up to 15mA of bias current into a 50Ω to 75Ω VCSEL load with 40μA resolution. The bias current is controlled through the 3-wire digital interface using the SET\_IBIAS, IBIASMAX, and BIASINC registers.

For VCSEL operation, the IBIASMAX register is first programmed to a desired maximum bias current value (up to 15mA). The bias current to the VCSEL then can range from zero to the value programmed into the IBIASMAX register. The bias current level is stored in the 9-bit SET\_IBIAS register. Only bits 1 to 8 are written to. The LSB (bit 0) of SET\_IBIAS is initialized to zero and is updated through the BIASINC register.

The value of the SET\_IBIAS DAC register is updated when the BIASINC register is addressed through the 3-wire interface. The BIASINC register is an 8-bit register where the first 5 bits contain the increment information in two's complement notation. Increment values range from -8 to +7 LSBs. If the updated value of SET\_IBIAS[8:1] exceeds IBIASMAX[7:0], the IBIASERR warning flag is set and SET\_IBIAS[8:0] remains unchanged.

## **Modulation Current DAC**

The modulation current from the MAX3799 is optimized to provide up to 12mA of modulation current into a 100Ω differential load with 40μA resolution. The modulation current is controlled through the 3-wire digital interface using the SET\_IMOD, IMODMAX, MODINC, and SET\_TXDE registers.

For VCSEL operation, the IMODMAX register is first programmed to a desired maximum modulation current value (up to 12mA into a 100Ω differential load). The modulation current to the VCSEL then can range from zero to the value programmed into the IMODMAX register. The modulation current level is stored in the 9-bit SET\_IMOD register. Only bits 1 to 8 are written to. The LSB (bit 0) of SET\_IMOD is initialized to zero and is updated through the MODINC register.

The value of the SET\_IMOD DAC register is updated when the MODINC register is addressed through the 3-wire interface. The MODINC register is an 8-bit register where the first 5 bits contain the increment information in two's complement notation. Increment values range from -8 to +7 LSBs. If the updated value of

SET\_IMOD[8:1] exceeds IMODMAX[7:0], the IMODERR warning flag is set and SET\_IMOD[8:0] remains unchanged.

## **Output Driver**

The output driver is optimized for an AC-coupled 100Ω differential load. The output stage also features programmable deemphasis that allows the deemphasis amplitude to be set as a percentage of the modulation current. The deemphasis function is enabled by the TXDE\_EN bit. At initial setup, the required amount of deemphasis can be set using the SET\_TXDE register. During the system operation, it is advised to use the incremental mode that updates the deemphasis (SET\_TXDE) and the modulation current DAC (SET\_IMOD) simultaneously through the MODINC register.

## **Power-On Reset (POR)**

Power-on reset ensures that the laser is off until the supply voltage has reached a specified threshold (2.55V). After power-on reset, bias current and modulation current ramp up slowly to avoid an overshoot. In the case of a POR, all registers are reset to their default values.

## **Bias Current Monitor**

Current out of the BMON pin is typically 1/16th the value of IBIAS. A resistor to ground at BMON sets the voltage gain. An internal comparator latches a SOFT FAULT if the voltage on BMON exceeds the value of  $V_{CC} - 0.55V$ .

## **Eye Safety and Output Control Circuitry**

The safety and output control circuitry contains a disable pin (DISABLE) and disable bit (TX\_EN), along with a FAULT indicator and fault detectors (Figure 3). The MAX3799 has two types of faults, HARD FAULT and SOFT FAULT. A HARD FAULT triggers the FAULT pin and the output to the VCSEL is disabled. A SOFT FAULT operates more like a warning and the outputs are not disabled. Both types of faults are stored in the TXSTAT1 and TXSTAT2 registers.

The FAULT pin is a latched output that can be cleared by toggling the DISABLE pin. Toggling the DISABLE pin also clears the TXSTAT1 and TXSTAT2 registers. A single-point fault can be a short to VCC or GND. Table 3 shows the circuit response to various single-point failures.

# 1Gbps to 14Gbps, SFP+ Multirate Limiting Amplifier and VCSEL Driver

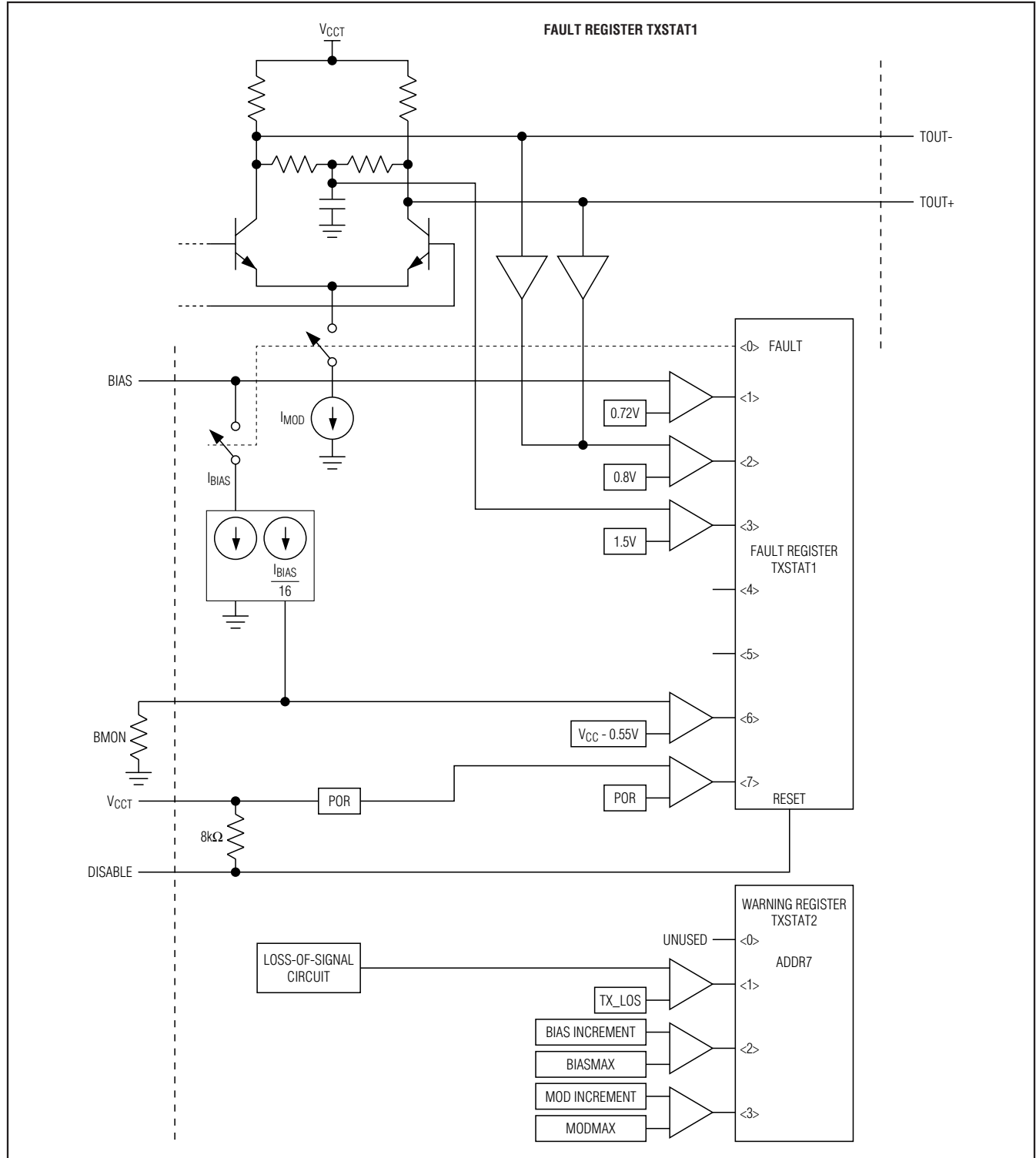

Figure 3. Eye Safety Circuitry

# 1Gbps to 14Gbps, SFP+ Multirate Limiting Amplifier and VCSEL Driver

MAX3799

**Table 3. Circuit Response to Single-Point Faults**

PIN	NAME	SHORT TO V <sub>CC</sub>	SHORT TO GND	OPEN
1	LOS	Normal (Note 1)	Normal (Note 1)	Normal (Note 1)
2	RSEL	Normal (Note 1)	Normal (Note 1)	Normal (Note 1)
3	V <sub>CCR</sub>	Normal	Disabled—HARD FAULT (external supply shorted) (Note 2)	Normal (Note 3)—Redundant path
4	ROUT+	Normal (Note 1)	Normal (Note 1)	Normal (Note 1)
5	ROUT-	Normal (Note 1)	Normal (Note 1)	Normal (Note 1)
6	V <sub>CCR</sub>	Normal	Disabled—HARD FAULT (external supply shorted) (Note 2)	Normal (Note 3)—Redundant path
7	V <sub>CCD</sub>	Normal	Disabled—HARD FAULT	Disabled—HARD FAULT
8	DISABLE	Disabled	Normal (Note 1). Can only be disabled with other means.	Disabled
9	SCL	Normal (Note 1)	Normal (Note 1)	Normal (Note 1)
10	SDA	Normal (Note 1)	Normal (Note 1)	Normal (Note 1)
11	CSEL	Normal (Note 1)	Normal (Note 1)	Normal (Note 1)
12	V <sub>CCT</sub>	Normal	Disabled—Fault (external supply shorted) (Note 2)	Normal (Note 3)—Redundant path
13	TIN+	SOFT FAULT	SOFT FAULT	Normal (Note 1)
14	TIN-	SOFT FAULT	SOFT FAULT	Normal (Note 1)
15	V <sub>CCT</sub>	Normal	Disabled—Fault (external supply shorted) (Note 2)	Normal (Note 3)—Redundant path
16	BMON	Disabled—HARD FAULT	Normal (Note 1)	Disabled—HARD FAULT
17	V <sub>EET</sub>	Disabled—Fault (external supply shorted) (Note 2)	Normal	Disabled—HARD FAULT
18	V <sub>CCT</sub>	Normal	Disabled—Fault (external supply shorted) (Note 2)	Normal (Note 3)—Redundant path
19	TOUT-	I <sub>MOD</sub> is reduced	Disabled—HARD FAULT	I <sub>MOD</sub> is reduced
20	TOUT+	I <sub>MOD</sub> is reduced	Disabled—HARD FAULT	I <sub>MOD</sub> is reduced
21	V <sub>CCT</sub>	Normal	Disabled—Fault (external supply shorted) (Note 2)	Normal (Note 3)—Redundant path
22	BIAS	I <sub>BIAS</sub> is on—No Fault	Disabled—HARD FAULT	Disabled—HARD FAULT
23	FAULT	Normal (Note 1)	Normal (Note 1)	Normal (Note 1)
24	V <sub>CCT</sub>	Normal	Disabled—Fault (external supply shorted) (Note 2)	Normal (Note 3)—Redundant path
25	V <sub>CCT</sub>	Normal	Disabled—Fault (external supply shorted) (Note 2)	Normal (Note 3)—Redundant path
26	V <sub>EER</sub>	Disabled—Fault (external supply shorted) (Note 2)	Normal	Normal (Note 3)—Redundant path
27	V <sub>CCR</sub>	Normal	Disabled—HARD FAULT (external supply shorted) (Note 2)	Normal (Note 3)—Redundant path
28	RIN-	Normal (Note 1)	Normal (Note 1)	Normal (Note 1)
29	RIN+	Normal (Note 1)	Normal (Note 1)	Normal (Note 1)

# 1Gbps to 14Gbps, SFP+ Multirate Limiting Amplifier and VCSEL Driver

**Table 3. Circuit Response to Single-Point Faults (continued)**

PIN	NAME	SHORT TO V <sub>CC</sub>	SHORT TO GND	OPEN
30	VCCR	Normal	Disabled—Fault (external supply shorted) (Note 2)	Normal (Note 3)—Redundant path
31	CAZ2	Normal (Note 1)	Normal (Note 1)	Normal (Note 1)
32	CAZ1 (VEER)	Disabled—Fault (external supply shorted) (Note 2)	Normal (Note 3)—Redundant path	Normal (Note 3)—Redundant path

**Note 1:** Normal—Does not affect laser power.

**Note 2:** Supply-shortened current is assumed to be primarily on the circuit board (outside this device) and the main supply is collapsed by the short.

**Note 3:** Normal in functionality, but performance could be affected.

**Warning:** Shorted to V<sub>CC</sub> or shorted to ground on some pins can violate the *Absolute Maximum Ratings*.

### 3-Wire Digital Communication

The MAX3799 implements a proprietary 3-wire digital interface. An external controller generates the clock. The 3-wire interface consists of an SDA bidirectional data line, an SCL clock signal input, and a CSEL chip-select input (active high). The external master initiates a data transfer by asserting the CSEL pin. The master starts to generate a clock signal after the CSEL pin has been set to 1. All data transfers are most significant bit (MSB) first.

#### Protocol

Each operation consists of 16-bit transfers (15-bit address/data, 1-bit RWN). The bus master generates 16 clock cycles to SCL. All operations transfer 8 bits to the MAX3799. The RWN bit determines if the cycle is read or write. See Table 4.

#### Register Addresses

The MAX3799 contains 17 registers available for programming. Table 5 shows the registers and addresses.

#### Write Mode (RWN = 0)

The master generates 16 clock cycles at SCL in total. The master outputs a total of 16 bits (MSB first) to the SDA line at the falling edge of the clock. The master closes the transmission by setting CSEL to 0. Figure 4 shows the interface timing.

#### Read Mode (RWN = 1)

The master generates 16 clock cycles at SCL in total. The master outputs a total of 8 bits (MSB first) to the SDA line at the falling edge of the clock. The SDA line is released after the RWN bit has been transmitted. The slave outputs 8 bits of data (MSB first) at the rising edge of the clock. The master closes the transmission by setting CSEL to 0. Figure 4 shows the interface timing.

#### Mode Control

Normal mode allows read-only instruction for all registers except MODINC and BIASINC. The MODINC and BIASINC registers can be updated during normal mode. Doing so speeds up the laser control update through the 3-wire interface by a factor of two. The normal mode is the default mode.

Setup mode allows the master to write unrestricted data into any register except the status (TXSTAT1, TXSTAT2, and RXSTAT) registers. To enter the setup mode, the MODECTRL register (address = H0x0E) must be set to H0x12. After the MODECTRL register has been set to H0x12, the next operation is unrestricted. The setup mode is automatically exited after the next operation is finished. This sequence must be repeated if further unrestricted settings are necessary.

**Table 4. Digital Communication Word Structure**

BIT															
15	14	13	12	11	10	9	8	7	6	5	4	3	2	1	0
Register Address							RWN	Data that is written or read.							

# 1Gbps to 14Gbps, SFP+ Multirate Limiting Amplifier and VCSEL Driver

Table 5. Register Descriptions and Addresses

ADDRESS	NAME	FUNCTION
H0x00	RXCTRL1	Receiver Control Register 1
H0x01	RXCTRL2	Receiver Control Register 2
H0x02	RXSTAT	Receiver Status Register
H0x03	SET_CML	Output CML Level Setting Register
H0x04	SET_LOS	LOS Threshold Level Setting Register
H0x05	TXCTRL	Transmitter Control Register
H0x06	TXSTAT1	Transmitter Status Register 1
H0x07	TXSTAT2	Transmitter Status Register 2
H0x08	SET_IBIAS	Bias Current Setting Register
H0x09	SET_IMOD	Modulation Current Setting Register
H0x0A	IMODMAX	Maximum Modulation Current Setting Register
H0x0B	IBIASMAX	Maximum Bias Current Setting Register
H0x0C	MODINC	Modulation Current Increment Setting Register
H0x0D	BIASINC	Bias Current Increment Setting Register
H0x0E	MODECTRL	Mode Control Register
H0x0F	SET_PWCTRL	Transmitter Pulse-Width Control Register
H0x10	SET_TXDE	Transmitter Deemphasis Control Register

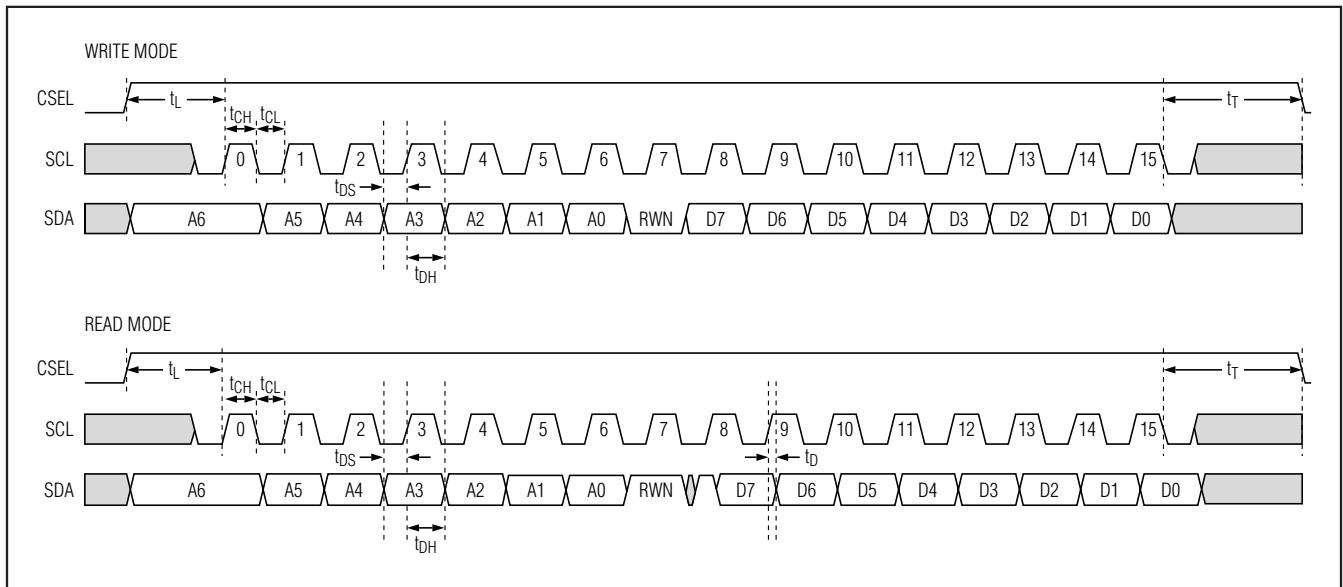

Figure 4. Timing for 3-Wire Digital Interface

# 1Gbps to 14Gbps, SFP+ Multirate Limiting Amplifier and VCSEL Driver

## Register Descriptions

### Receiver Control Register 1 (RXCTRL1)

Bit #	7	6	5	4	3	2	1	0	ADDRESS
Name	X	X	X	X	X	X	RATE_SEL	X	H0x00
Default Value	X	X	X	X	X	X	0	X	

**Bit 1: RATE\_SEL.** RATE\_SEL combined with the RSEL pin through a logic-OR function selects between the low data-rate mode (1.25Gbps) or high data-rate mode (up to 10.32Gbps).

Logic-OR output 0 = 1Gbps mode

Logic-OR output 1 = 10Gbps mode

### Receiver Control Register 2 (RXCTRL2)

Bit #	7	6	5	4	3	2	1	0	ADDRESS
Name	X	LOS_EN	LOS_POL	RX_POL	SQ_EN	RX_EN	RXDE_EN	AZ_EN	H0x01
Default Value	X	1	1	1	0	1	0	1	

**Bit 6: LOS\_EN.** Controls the LOS circuitry. When RX\_EN is set to 0, the LOS detector is also disabled.

0 = disabled

1 = enabled

**Bit 5: LOS\_POL.** Controls the output polarity of the LOS pin.

0 = inverse

1 = normal

**Bit 4: RX\_POL.** Controls the polarity of the receiver signal path.

0 = inverse

1 = normal

**Bit 3: SQ\_EN:** When SQ\_EN = 1, the LOS controls the output circuitry.

0 = disabled

1 = enabled

**Bit 2: RX\_EN.** Enables or disables the receive circuitry.

0 = disabled

1 = enabled

**Bit 1: RXDE\_EN.** Enables or disables the deemphasis on the receiver output.

0 = disabled

1 = enabled

**Bit 0: AZ\_EN.** Enables or disables the autozero circuitry. When RX\_EN is set to 0, the autozero circuitry is also disabled.

0 = disabled

1 = enabled

# 1Gbps to 14Gbps, SFP+ Multirate Limiting Amplifier and VCSEL Driver

## Receiver Status Register (RXSTAT)

Bit #	7	6	5	4	3	2	1	0 (STICKY)	ADDRESS
Name	X	X	X	X	X	X	X	LOS	H0x02
Default Value	X	X	X	X	X	X	X	X	

**Bit 0: LOS.** Copy of the LOS output circuitry. This is a sticky bit, which means that it is cleared on a read. The first 0-to-1 transition gets latched until the bit is read by the master or POR occurs.

## Output CML Level Setting Register (SET\_CML)

Bit #	7	6	5	4	3	2	1	0	ADDRESS
Name	SET_CML[7] (MSB)	SET_CML[6]	SET_CML[5]	SET_CML[4]	SET_CML[3]	SET_CML[2]	SET_CML[1]	SET_CML[0] (LSB)	H0x03
Default Value	0	1	0	1	0	0	1	1	

**Bits 7 to 0: SET\_CML[7:0].** The SET\_CML register is an 8-bit register that can be set up to R15, corresponding to an output up to 1000mV<sub>P-P</sub>. See the *Typical Operating Characteristics* section for a typical CML output voltage vs. DAC code graph.

## LOS Threshold Level Setting Register (SET\_LOS)

Bit #	7	6	5	4	3	2	1	0	ADDRESS
Name	X	X	SET_LOS[5] (MSB)	SET_LOS[4]	SET_LOS[3]	SET_LOS[2]	SET_LOS[1]	SET_LOS[0] (LSB)	H0x04
Default Value	X	X	0	0	1	1	0	0	

**Bits 5 to 0: SET\_LOS[5:0].** The SET\_LOS register is a 6-bit register used to program the LOS threshold. See the *Typical Operating Characteristics* section for a typical LOS threshold voltage vs. DAC code graph.

# 1Gbps to 14Gbps, SFP+ Multirate Limiting Amplifier and VCSEL Driver

## Transmitter Control Register (TXCTRL)

Bit #	7	6	5	4	3	2	1	0	ADDRESS
Name	X	X	X	X	TXDE_EN	SOFTRES	TX_POL	TX_EN	H0x05
Default Value	X	X	X	X	0	0	1	1	

**Bit 3: TXDE\_EN.** Enables or disables the transmit output deemphasis circuitry.

0 = disabled

1 = enabled

**Bit 2: SOFTRES.** Resets all registers to their default values.

0 = normal

1 = reset

**Bit 1: TX\_POL.** Controls the polarity of the transmit signal path.

0 = inverse

1 = normal

**Bit 0: TX\_EN.** Enables or disables the transmit circuitry.

0 = disabled

1 = enabled

## Transmitter Status Register 1 (TXSTAT1)

Bit #	7 (STICKY)	6 (STICKY)	5 (STICKY)	4 (STICKY)	3 (STICKY)	2 (STICKY)	1 (STICKY)	0 (STICKY)	ADDRESS
Name	FST[7]	FST[6]	X	X	FST[3]	FST[2]	FST[1]	TX_FAULT	H0x06
Default Value	X	X	X	X	X	X	X	X	

**Bit 7: FST[7].** When the  $V_{CC1}$  supply voltage is below 2.45V, the POR circuitry reports a FAULT. Once the  $V_{CC1}$  supply voltage is above 2.55V, the POR resets all registers to their default values and the FAULT is cleared.

**Bit 6: FST[6].** When the voltage at BMON is above  $V_{CC} - 0.55V$ , a SOFT FAULT is reported.

**Bit 3: FST[3].** When the common-mode voltage at  $V_{TOUT+/-}$  goes below 1.5V, a SOFT FAULT is reported.

**Bit 2: FST[2].** When the voltage at  $V_{TOUT+/-}$  goes below 0.8V, a HARD FAULT is reported.

**Bit 1: FST[1].** When the BIAS voltage goes below 0.44V, a HARD FAULT is reported.

**Bit 0: TX\_FAULT.** Copy of a FAULT signal in FST[7] to FST[1]. A POR resets FST[7:1] to 0.

## Transmitter Status Register 2 (TXSTAT2)

Bit #	7	6	5	4	3 (STICKY)	2 (STICKY)	1 (STICKY)	0 (STICKY)	ADDRESS
Name	X	X	X	X	IMODERR	IBIASERR	TXED	X	H0x07
Default Value	X	X	X	X	X	X	X	X	

**Bit 3: IMODERR.** When the modulation-incremented result is greater than IMODMAX, a SOFT FAULT is reported. See the *Programming Modulation Current* section.



# 1Gbps to 14Gbps, SFP+ Multirate Limiting Amplifier and VCSEL Driver

**Bit 2: IBIASERR.** When the bias incremented result is greater than IBIASMAX, then a SOFT FAULT is reported. See the *Programming Bias Current* section.

**Bit 1: TXED.** This only indicates the absence of an AC signal at the transmit input. This is not an LOS indicator.

## Bias Current Setting Register (SET\_IBIAS)

Bit #	7	6	5	4	3	2	1	0	ADDRESS
Name	SET_IBIAS [8] (MSB)	SET_IBIAS [7]	SET_IBIAS [6]	SET_IBIAS [5]	SET_IBIAS [4]	SET_IBIAS [3]	SET_IBIAS [2]	SET_IBIAS [1]	H0x08
Default Value	0	0	0	0	0	1	0	0	

**Bits 7 to 0: SET\_IBIAS[8:1].** The bias current DAC is controlled by a total of 9 bits. The SET\_IBIAS[8:1] bits are used to set the bias current with even denominations from 0 to 510 bits. The LSB (SET\_IBIAS[0]) bit is controlled by the BIASINC register and is used to set the odd denominations in the SET\_IBIAS[8:0].

## Modulation Current Setting Register (SET\_IMOD)

Bit #	7	6	5	4	3	2	1	0	ADDRESS
Name	SET_IMOD [8] (MSB)	SET_IMOD [7]	SET_IMOD [6]	SET_IMOD [5]	SET_IMOD [4]	SET_IMOD [3]	SET_IMOD [2]	SET_IMOD [1]	H0x09
Default Value	0	0	0	1	0	0	1	0	

**Bits 7 to 0: SET\_IMOD[8:1].** The modulation current DAC is controlled by a total of 9 bits. The SET\_IMOD[8:1] bits are used to set the modulation current with even denominations from 0 to 510 bits. The LSB (SET\_IMOD[0]) bit is controlled by the MODINC register and is used to set the odd denominations in the SET\_IMOD[8:0].

## Maximum Modulation Current Setting Register (IMODMAX)

Bit #	7	6	5	4	3	2	1	0	ADDRESS
Name	IMODMAX [7] (MSB)	IMODMAX [6]	IMODMAX [5]	IMODMAX [4]	IMODMAX [3]	IMODMAX [2]	IMODMAX [1]	IMODMAX [0] (LSB)	H0x0A
Default Value	0	0	1	1	0	0	0	0	

**Bits 7 to 0: IMODMAX[7:0].** The IMODMAX register is an 8-bit register that can be used to limit the maximum modulation current. IMODMAX[7:0] is continuously compared to the SET\_IMOD[8:1].

## Maximum Bias Current Setting Register (IBIASMAX)

Bit #	7	6	5	4	3	2	1	0	ADDRESS
Name	IBIASMAX [7] (MSB)	IBIASMAX [6]	IBIASMAX [5]	IBIASMAX [4]	IBIASMAX [3]	IBIASMAX [2]	IBIASMAX [1]	IBIASMAX [0] (LSB)	H0x0B
Default Value	0	0	0	1	0	0	1	0	

**Bits 7 to 0: IBIASMAX[7:0].** The IBIASMAX register is an 8-bit register that can be used to limit the maximum bias current. IBIASMAX[7:0] is continuously compared to the SET\_IBIAS[8:1].

# 1Gbps to 14Gbps, SFP+ Multirate Limiting Amplifier and VCSEL Driver

## Modulation Current Increment Setting Register (MODINC)

Bit #	7	6	5	4	3	2	1	0	ADDRESS
Name	SET_IMOD[0]	X	DE_INC	MODINC[4] (MSB)	MODINC[3]	MODINC[2]	MODINC[1]	MODINC[0] (LSB)	H0x0C
Default Value	0	0	0	0	0	0	0	0	

**Bit 7: SET\_IMOD[0].** This is the LSB of the SET\_IMOD[8:0] bits. This bit can only be updated by the use of MODINC[4:0].

**Bit 5: DE\_INC.** When this bit is set to 1 and the deemphasis on the transmit output is enabled, the SET\_TXDE[3:0] is incremented or decremented by 1 LSB. The increment or decrement is determined by the sign bit of the MODINC[4:0] string of bits.

**Bits 4 to 0: MODINC[4:0].** This string of bits is used to increment or decrement the modulation current. When written to, the SET\_IMOD[8:0] bits are updated. MODINC[4:0] are a two's complement string.

## Bias Current Increment Setting Register (BIASINC)

Bit #	7	6	5	4	3	2	1	0	ADDRESS
Name	SET_IBIAS[0]	X	X	BIASINC[4] (MSB)	BIASINC[3]	BIASINC[2]	BIASINC[1]	BIASINC[0] (LSB)	H0x0D
Default Value	0	0	0	0	0	0	0	0	

**Bit 7: SET\_IBIAS[0].** This is the LSB of the SET\_IBIAS[8:0] bits. This bit can only be updated by the use of BIASINC[4:0].

**Bits 4 to 0: BIASINC[4:0].** This string of bits is used to increment or decrement the bias current. When written to, the SET\_IBIAS[8:0] bits are updated. BIASINC[4:0] are a two's complement string.

## Mode Control Register (MODECTRL)

Bit #	7	6	5	4	3	2	1	0	ADDRESS
Name	MODECTRL[7] (MSB)	MODECTRL[6]	MODECTRL[5]	MODECTRL[4]	MODECTRL[3]	MODECTRL[2]	MODECTRL[1]	MODECTRL[0] (LSB)	H0x0E
Default Value	0	0	0	0	0	0	0	0	

**Bits 7 to 0: MODECTRL[7:0].** The MODECTRL register enables a switch between normal and setup modes. The setup mode is achieved by setting this register to H0x12. MODECTRL must be updated before each write operation. Exceptions are MODINC and BIASINC, which can be updated in normal mode.

## Transmitter Pulse-Width Control Register (SET\_PWCTRL)

Bit #	7	6	5	4	3	2	1	0	ADDRESS
Name	X	X	X	X	SET_PWCTRL[3] (MSB)	SET_PWCTRL[2]	SET_PWCTRL[1]	SET_PWCTRL[0] (LSB)	H0x0F
Default Value	X	X	X	X	0	0	0	0	

**Bits 3 to 0: SET\_PWCTRL[3:0].** This is a 4-bit register used to control the eye crossing by adjusting the pulse width.

# 1Gbps to 14Gbps, SFP+ Multirate Limiting Amplifier and VCSEL Driver

## Transmitter Deemphasis Control Register (SET\_TXDE)

Bit #	7	6	5	4	3	2	1	0	ADDRESS
Name	X	X	X	X	SET_TXDE [3] (MSB)	SET_TXDE [2]	SET_TXDE [1]	SET_TXDE [0] (LSB)	H0x10
Default Value	X	X	X	X	0	0	0	0	

**Bits 3 to 0: SET\_TXDE[3:0].** This is a 4-bit register used to control the amount of deemphasis on the transmitter output. When calculating the total modulation current, the amount of deemphasis must be taken into account. The deemphasis is set as a percentage of modulation current.

### Design Procedure

#### Programming Bias Current

- 1) IBIASMAX[7:0] = Maximum\_Bias\_Current\_Value
- 2) SET\_IBIAS<sub>i</sub>[8:1] = Initial\_Bias\_Current\_Value

**Note:** The total bias current value is calculated using the SET\_IBIAS[8:0] register. SET\_IBIAS[8:1] are the bits that can be manually written. SET\_IBIAS[0] can only be updated using the BIASINC[7:0] register.

When implementing an APC loop, it is recommended to use the BIASINC[7:0] register, which guarantees the fastest bias current update.

- 3) BIASINC<sub>i</sub>[4:0] = New\_Increment\_Value
- 4) If (SET\_IBIAS<sub>i</sub>[8:1] ≤ IBIASMAX[7:0]),  
then (SET\_IBIAS<sub>i</sub>[8:0] = SET\_IBIAS<sub>i-1</sub>[8:0] + BIASINC<sub>i</sub>[4:0])
- 5) Else (SET\_IBIAS<sub>i</sub>[8:0] = SET\_IBIAS<sub>i-1</sub>[8:0])

The total bias current can be calculated as follows:

- 6) I<sub>BIAS</sub> = [SET\_IBIAS<sub>i</sub>[8:0] + 20] × 40μA

#### Programming Modulation Current

- 1) IMODMAX[7:0] = Maximum\_Modulation\_Current\_Value
- 2) SET\_IMOD<sub>i</sub>[8:1] = Initial\_Modulation\_Current\_Value

**Note:** The total modulation current value is calculated using the SET\_IMOD[8:0] register. SET\_IMOD[8:1] are the bits that can be manually written. SET\_IMOD[0] can only be updated using the MODINC[7:0] register.

When implementing modulation compensation, it is recommended to use the MODINC[7:0] register, which guarantees the fastest modulation current update.

- 3) MODINC<sub>i</sub>[4:0] = New\_Increment\_Value
- 4) If (SET\_IMOD<sub>i</sub>[8:1] ≤ IMODMAX[7:0]),  
then (SET\_IMOD<sub>i</sub>[8:0] = SET\_IMOD<sub>i-1</sub>[8:0] + MODINC<sub>i</sub>[4:0])
- 5) Else (SET\_IMOD<sub>i</sub>[8:0] = SET\_IMOD<sub>i-1</sub>[8:0])

The following equation is valid with assumption of 100Ω on-chip and 100Ω external differential load (R<sub>extd</sub>). The maximum value that can be set for SET\_TXDE[3:0] = 11.

$$6) \quad I_{\text{MOD}}(\text{R}_{\text{extd}}=100\Omega) = [(20 + \text{SET\_IMOD}_i[8:0]) \times 40\mu\text{A}] \\ \times \left[ 1 - \frac{2 + \text{SET\_TXDE}[3:0]}{64} \right]$$

For general R<sub>extd</sub>, the modulation current that is achieved using the same setting of SET\_IMOD<sub>i</sub>[8:0] as for R<sub>extd</sub> = 100Ω is shown below. It can be written as a function of I<sub>MOD</sub>(R<sub>extd</sub>=100Ω), still assuming a 100Ω on-chip load.

$$7) \quad I_{\text{MOD}}(\text{R}_{\text{extd}}) = 2 \times I_{\text{MOD}}(\text{R}_{\text{extd}}=100\Omega) \left[ \frac{\text{R}_{\text{ext}}}{\text{R}_{\text{ext}} + 100} \right]$$

#### Programming LOS Threshold

$$\text{LOSTH} = (\text{SET\_LOS}[7:0] \times 1.5\text{mV}_{\text{P-P}})$$

#### Programming Transmit Output Deemphasis

The TXDE\_EN bit must be set to 1 to enable the deemphasis function. The SET\_TXDE register value is used to set the amount of deemphasis, which is a percentage of the modulation current. Deemphasis percentage is determined as:

$$\text{DE}(\%) = \frac{100 \times (2 + \text{SET\_TXDE}[3:0])}{64}$$

where the maximum SET\_TXDE[3:0] = 11.

For an I<sub>MOD</sub> value of 10mA, the maximum achievable deemphasis value is approximately 20%. Maximum deemphasis achievable for full I<sub>MOD</sub> range of 12mA is limited to 15%.

With deemphasis enabled, the value of the modulation current amplitude is reduced by the calculated deemphasis percentage. To maintain the modulation current amplitude constant, the SET\_IMOD[8:0] register must be increased by the deemphasis percentage. If the system conditions like temperature, required I<sub>MOD</sub> value, etc., change during the transmit operation, the deemphasis setting might need to be readjusted. For such an

# 1Gbps to 14Gbps, SFP+ Multirate Limiting Amplifier and VCSEL Driver

impromptu deemphasis adjustment, it is recommended that the DE\_INC (MODINC[5]) bit is used. Use of this bit increments or decrements the deemphasis code setting by 1 LSB based on the sign of increment in the MODINC[4:0] and, hence, the SET\_IMOD[8:0] setting. This helps maintain the BER while having the flexibility to improve signal quality by adjusting deemphasis while the transmit operation continues. This feature enables glitchless deemphasis adjustment while maintaining excellent BER performance.

## Activating Receiver Output Deemphasis

The RXDE\_EN bit must be set to 1 to enable the deemphasis function. Deemphasis decreases the output amplitude at ROUT+/ROUT- by 25%. To maintain the same output amplitude as before the activation of deemphasis, the SET\_CML register value needs to be increased by 25%. When deemphasis is enabled, the limiting amplifier AC performance is guaranteed up to 800mV<sub>P-P</sub> typical output amplitude. The SET\_CML register can be set from 0 to 255 bits, but it is important to note that performance is guaranteed up to 215 bits.

## Programming Pulse-Width Control

The eye crossing at the Tx output can be adjusted using the SET\_PWCTRL register. Table 6 shows these settings.

The sign of the number specifies the direction of pulse-width distortion. The code of 1111 corresponds to a balanced state for differential output. The pulse-width distortion is bidirectional around the balanced state (see the *Typical Operating Characteristics* section).

## Programming CML Output Settings

Amplitude of the CML output stage is controlled by an 8-bit DAC register (SET\_CML). The differential output amplitude is up to 1000mV<sub>P-P</sub> with 4.6mV<sub>P-P</sub> resolution (assuming an ideal 100Ω differential load). The guaranteed output CML DAC range is up to 215.

$$\text{Output Voltage } R_{OUT} \text{ (mV}_{P-P}\text{)} = 40 + 4.55 (\text{SET\_CML})$$

## Select the Coupling Capacitor

For AC-coupling, the coupling capacitors C<sub>IN</sub> and C<sub>OUT</sub> should be selected to minimize the receiver's deterministic jitter. Jitter is decreased as the input low-frequency cutoff (f<sub>IN</sub>) is decreased.

$$f_{IN} = 1/[2\pi(50)(C_{IN})]$$

The recommended C<sub>IN</sub> and C<sub>OUT</sub> is 0.1μF for the MAX3799.

## Select the Offset-Correction Capacitor

The capacitor between CAZ1 and CAZ2 determines the time constant of the signal path DC-offset cancellation loop. To maintain stability, it is important to keep at

least a one-decade separation between f<sub>IN</sub> and the low-frequency cutoff (f<sub>OC</sub>) associated with the DC-offset cancellation circuit. A 1nF capacitor between CAZ1 and CAZ2 is recommended for the MAX3799.

## Applications Information

### Layout Considerations

To minimize inductance, keep the connections between the MAX3799 output pins and laser diode as close as possible. Optimize the laser diode performance by placing a bypass capacitor as close as possible to the laser anode. Use good high-frequency layout techniques and multiple-layer boards with uninterrupted ground planes to minimize EMI and crosstalk.

### Exposed-Pad Package

The exposed pad on the 32-pin TQFN provides a very low-thermal resistance path for heat removal from the IC. The pad is also electrical ground on the MAX3799 and must be soldered to the circuit board ground for proper thermal and electrical performance. Refer to Application Note 862: *HFAN-08.1: Thermal Considerations of QFN and Other Exposed-Paddle Packages* for additional information.

### Laser Safety and IEC 825

Using the MAX3799 laser driver alone does not ensure that a transmitter design is compliant with IEC 825. The entire transmitter circuit and component selections must be considered. Each user must determine the level of fault tolerance required by the application, recognizing that Maxim products are neither designed nor authorized for use as components in systems intended for surgical implant into the body, for applications intended to support or sustain life, or for any other application in which the failure of a Maxim product could create a situation where personal injury or death could occur.

**Table 6. Eye-Crossing Settings for SET\_PWCTRL**

SET_PWCTRL[3:0]	PWD	SET_PWCTRL[3:0]	PWD
1000	-7	0111	8
1001	-6	0110	7
1010	-5	0101	6
1011	-4	0100	5
1100	-3	0011	4
1101	-2	0010	3
1110	-1	0001	2
1111	0	0000	1

# 1Gbps to 14Gbps, SFP+ Multirate Limiting Amplifier and VCSEL Driver

MAX3799

Table 7. Register Summary

REGISTER FUNCTION/ ADDRESS	REGISTER NAME	NORMAL MODE	SETUP MODE	BIT NUMBER /TYPE	BIT NAME	DEFAULT VALUE	NOTES
Receiver Control Register 1 <b>Address = H0x00</b>	RXCTRL1	R	RW	1	RATE_SEL	0	Mode-select 0: high-gain mode, 1: high-bandwidth mode
Receiver Control Register 2 <b>Address = H0x01</b>	RXCTRL2	R	RW	6	LOS_EN	1	LOS control 0: disable, 1: enable (always 0 when RX_EN = 0)
		R	RW	5	LOS_POL	1	LOS polarity 0: inverse, 1: normal
		R	RW	4	RX_POL	1	Rx polarity 0: inverse, 1: normal
		R	RW	3	SQ_EN	0	Squelch 0: disable, 1: enable
		R	RW	2	RX_EN	1	Rx control 0: disable, 1: enable
		R	RW	1	RXDE_EN	0	Rx deemphasis 0: disable, 1: enable
		R	RW	0	AZ_EN	1	Rx autozero control 0: disable, 1: enable (always 0 when RX_EN = 0)
Receiver Status Register <b>Address = H0x02</b>	RXSTAT	R	R	0 (sticky)	LOS	X	Copy of LOS output signal
Output CML Level Setting Register <b>Address = H0x03</b>	SET_CML	R	RW	7	SET_CML[7]	0	MSB output level DAC
		R	RW	6	SET_CML[6]	1	
		R	RW	5	SET_CML[5]	0	
		R	RW	4	SET_CML[4]	1	
		R	RW	3	SET_CML[3]	0	
		R	RW	2	SET_CML[2]	0	
		R	RW	1	SET_CML[1]	1	
		R	RW	0	SET_CML[0]	1	LSB output level DAC
LOS Threshold Level Setting Register <b>Address = H0x04</b>	SET_LOS	R	RW	5	SET_LOS[5]	0	MSB LOS threshold DAC
		R	RW	4	SET_LOS[4]	0	
		R	RW	3	SET_LOS[3]	1	
		R	RW	2	SET_LOS[2]	1	
		R	RW	1	SET_LOS[1]	0	
		R	RW	0	SET_LOS[0]	0	LSB LOS threshold DAC

# 1Gbps to 14Gbps, SFP+ Multirate Limiting Amplifier and VCSEL Driver

Table 7. Register Summary (continued)

REGISTER FUNCTION/ ADDRESS	REGISTER NAME	NORMAL MODE	SETUP MODE	BIT NUMBER /TYPE	BIT NAME	DEFAULT VALUE	NOTES
Transmitter Control Register Address = H0x05	TXCTRL	R	RW	3	TXDE_EN	0	Tx deemphasis 0: disable, 1: enable
		R	RW	2	SOFTRES	0	Global digital reset
		R	RW	1	TX_POL	1	Tx polarity 0: inverse, 1: normal
		R	RW	0	TX_EN	1	Tx control 0: disable, 1: enable
Transmitter Status Register 1 Address = H0x06	TXSTAT1	R	R	7 (sticky)	FST[7]	X	TX_POR → TX_VCC low-limit violation
		R	R	6 (sticky)	FST[6]	X	BMON open/shorted to VCC
		R	R	5 (sticky)	X	X	
		R	R	4 (sticky)	X	X	
		R	R	3 (sticky)	FST[3]	X	VTOUT+/- common-mode low-limit violation
		R	R	2 (sticky)	FST[2]	X	VTOUT+/- low-limit violation
		R	R	1 (sticky)	FST[1]	X	BIAS open or shorted to GND
Transmitter Status Register 2 Address = H0x07	TXSTAT2	R	R	3 (sticky)	IMODERR	X	Warning increment result > IMODMAX
		R	R	2 (sticky)	IBIASERR	X	Warning increment result > IBIASMAX
		R	R	1 (sticky)	TXED	X	Tx edge detection
		R	R	0 (sticky)	Unused	X	Unused
Bias Current Setting Register Address = H0x08	SET_IBIAS	R	RW	8	SET_IBIAS[8]	0	MSB bias DAC
		R	RW	7	SET_IBIAS[7]	0	
		R	RW	6	SET_IBIAS[6]	0	
		R	RW	5	SET_IBIAS[5]	0	
		R	RW	4	SET_IBIAS[4]	0	
		R	RW	3	SET_IBIAS[3]	1	
		R	RW	2	SET_IBIAS[2]	0	
	R	RW	1	SET_IBIAS[1]	0		
		Accessible through REG_ADDR = 13		0	SET_IBIAS[0]	0	LSB bias DAC

# 1Gbps to 14Gbps, SFP+ Multirate Limiting Amplifier and VCSEL Driver

MAX3799

Table 7. Register Summary (continued)

REGISTER FUNCTION/ ADDRESS	REGISTER NAME	NORMAL MODE	SETUP MODE	BIT NUMBER /TYPE	BIT NAME	DEFAULT VALUE	NOTES
Modulation Current Setting Register <b>Address = H0x09</b>	SET_IMOD	R	RW	8	SET_IMOD[8]	0	MSB modulation DAC
		R	RW	7	SET_IMOD[7]	0	
		R	RW	6	SET_IMOD[6]	0	
		R	RW	5	SET_IMOD[5]	1	
		R	RW	4	SET_IMOD[4]	0	
		R	RW	3	SET_IMOD[3]	0	
		R	RW	2	SET_IMOD[2]	1	
		R	RW	1	SET_IMOD[1]	0	
		Accessible through REG_ADDR = 12		0	SET_IMOD[0]	0	LSB modulation DAC
Maximum Modulation Current Setting Register <b>Address = H0x0A</b>	IMODMAX	R	RW	7	IMODMAX[7]	0	MSB modulation limit
		R	RW	6	IMODMAX[6]	0	
		R	RW	5	IMODMAX[5]	1	
		R	RW	4	IMODMAX[4]	1	
		R	RW	3	IMODMAX[3]	0	
		R	RW	2	IMODMAX[2]	0	
		R	RW	1	IMODMAX[1]	0	
		R	RW	0	IMODMAX[0]	0	LSB modulation limit
Maximum Bias Current Setting Register <b>Address = H0x0B</b>	IBIASMAX	R	RW	7	IBIASMAX[7]	0	MSB bias limit
		R	RW	6	IBIASMAX[6]	0	
		R	RW	5	IBIASMAX[5]	0	
		R	RW	4	IBIASMAX[4]	1	
		R	RW	3	IBIASMAX[3]	0	
		R	RW	2	IBIASMAX[2]	0	
		R	RW	1	IBIASMAX[1]	1	
		R	RW	0	IBIASMAX[0]	0	LSB bias limit
Modulation Current Increment Setting Register <b>Address = H0x0C</b>	MODINC	R	R	7	SET_IMOD[0]	0	LSB of SET_IMOD DAC register address = H0x09
		R	R	6	X	0	
		R	R	5	DE_INC	0	Deemphasis increment 0: no update, 1: SET_TXDE updates $\pm 1$ LSB
		RW	RW	4	MODINC[4]	0	MSB MOD DAC two's complement
		RW	RW	3	MODINC[3]	0	
		RW	RW	2	MODINC[2]	0	
		RW	RW	1	MODINC[1]	0	
		RW	RW	0	MODINC[0]	0	LSB MOD DAC two's complement

# 1Gbps to 14Gbps, SFP+ Multirate Limiting Amplifier and VCSEL Driver

Table 7. Register Summary (continued)

REGISTER FUNCTION/ ADDRESS	REGISTER NAME	NORMAL MODE	SETUP MODE	BIT NUMBER /TYPE	BIT NAME	DEFAULT VALUE	NOTES
Bias Current Increment Setting Register <b>Address = H0x0D</b>	BIASINC	R	R	7	SET_IBIAS[0]	0	LSB of SET_IBIAS DAC register address = H0x08
		R	R	6	X	0	
		R	R	5	X	0	
		RW	RW	4	BIASINC[4]	0	MSB bias DAC two's complement
		RW	RW	3	BIASINC[3]	0	
		RW	RW	2	BIASINC[2]	0	
		RW	RW	1	BIASINC[1]	0	
Mode Control Register <b>Address = H0x0E</b>	MODECTRL	RW	RW	7	MODECTRL[7]	0	MSB mode control
		RW	RW	6	MODECTRL[6]	0	
		RW	RW	5	MODECTRL[5]	0	
		RW	RW	4	MODECTRL[4]	0	
		RW	RW	3	MODECTRL[3]	0	
		RW	RW	2	MODECTRL[2]	0	
		RW	RW	1	MODECTRL[1]	0	
Transmitter Pulse-Width Control Register <b>Address = H0x0F</b>	SET_PWCTRL	R	RW	3	SET_PWCTRL[3]	0	MSB Tx pulse-width control
		R	RW	2	SET_PWCTRL[2]	0	
		R	RW	1	SET_PWCTRL[1]	0	
		R	RW	0	SET_PWCTRL[0]	0	LSB Tx pulse-width control
Transmitter Deemphasis Control Register <b>Address = H0x10</b>	SET_TXDE	R	RW	3	SET_TXDE[3]	0	MSB Tx deemphasis
		R	RW	2	SET_TXDE[2]	0	
		R	RW	1	SET_TXDE[1]	0	
		R	RW	0	SET_TXDE[0]	0	LSB Tx deemphasis



# 1Gbps to 14Gbps, SFP+ Multirate Limiting Amplifier and VCSEL Driver

MAX3799

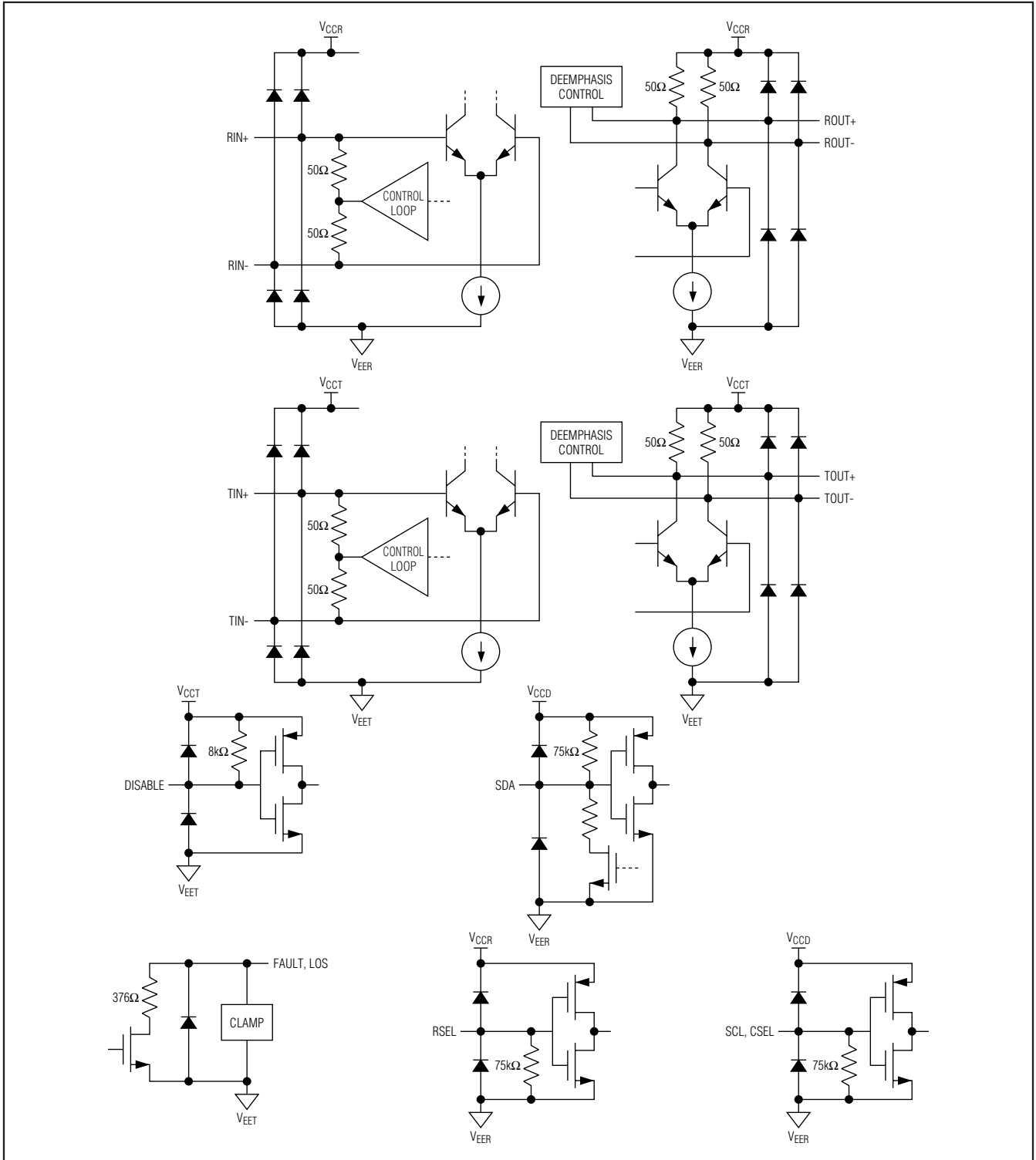
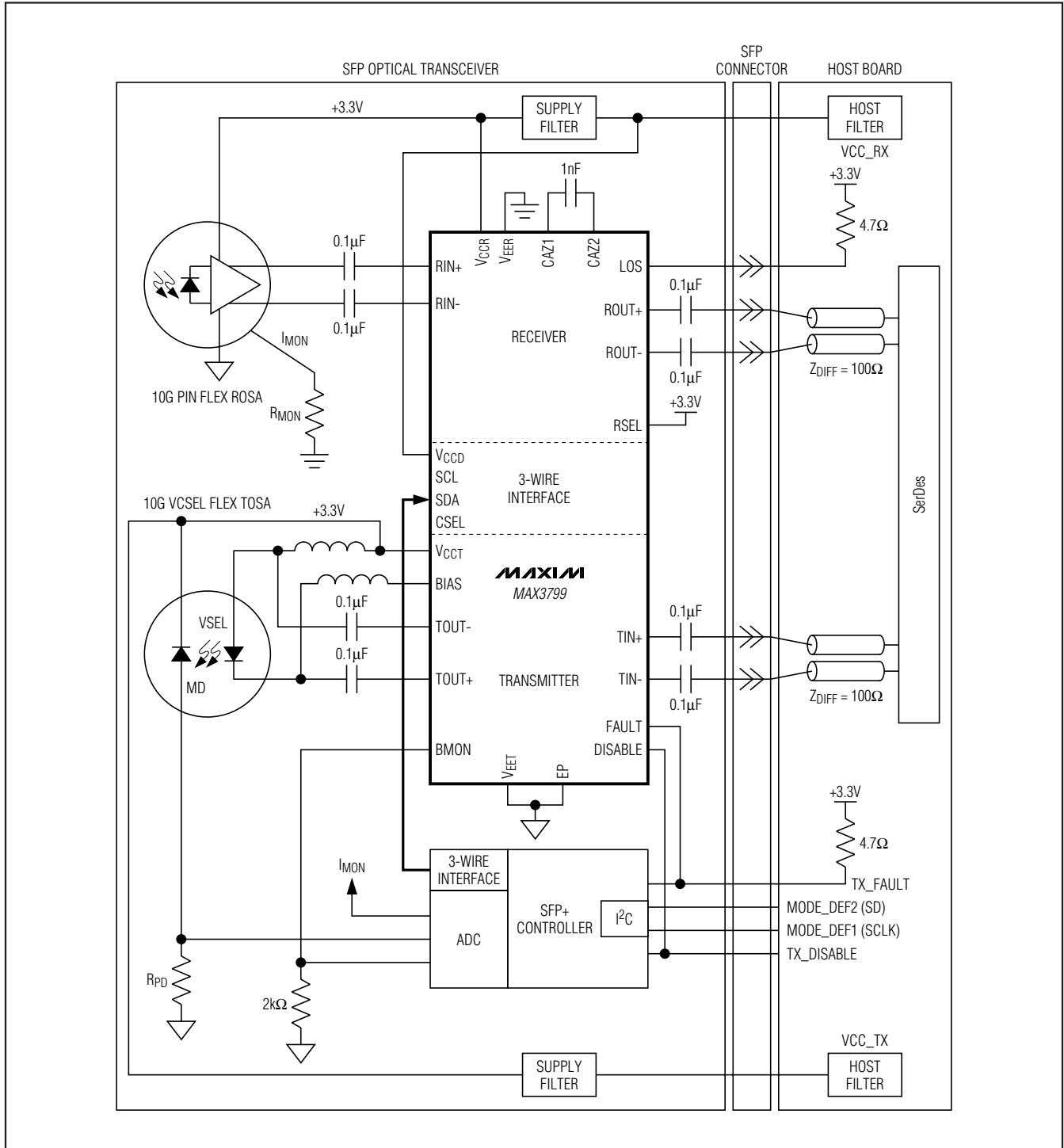

Figure 5. Simplified I/O Structures

# 1Gbps to 14Gbps, SFP+ Multirate Limiting Amplifier and VCSEL Driver

## Typical Application Circuit



# 1Gbps to 14Gbps, SFP+ Multirate Limiting Amplifier and VCSEL Driver

**MAX3799**

## Pin Configuration

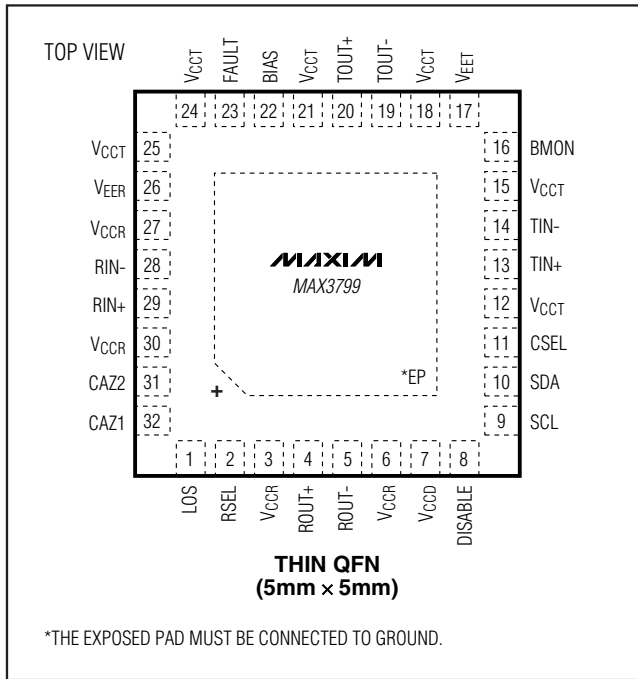

## Chip Information

PROCESS: SiGe BiPOLAR

## Package Information

For the latest package outline information and land patterns, go to [www.maxim-ic.com/packages](http://www.maxim-ic.com/packages).

PACKAGE TYPE	PACKAGE CODE	DOCUMENT NO.
32 TQFN-EP	T3255+3	<a href="#">21-0140</a>

Maxim cannot assume responsibility for use of any circuitry other than circuitry entirely embodied in a Maxim product. No circuit patent licenses are implied. Maxim reserves the right to change the circuitry and specifications without notice at any time.

Maxim Integrated Products, 120 San Gabriel Drive, Sunnyvale, CA 94086 408-737-7600 35