

MAX31856

Precision Thermocouple to Digital Converter with Linearization

General Description

The MAX31856 performs cold-junction compensation and digitizes the signal from any type of thermocouple. The output data is formatted in degrees Celsius. This converter resolves temperatures to 0.0078125°C, allows readings as high as +1800°C and as low as -210°C (depending on thermocouple type), and exhibits thermocouple voltage measurement accuracy of $\pm 0.15\%$. The thermocouple inputs are protected against overvoltage conditions up to $\pm 45\text{V}$.

A lookup table (LUT) stores linearity correction data for several types of thermocouples (K, J, N, R, S, T, E, and B). Line frequency filtering of 50Hz and 60Hz is included, as is thermocouple fault detection. A SPI-compatible interface allows selection of thermocouple type and setup of the conversion and fault detection processes.

Applications

- Temperature Controllers
- Industrial Ovens, Furnaces, and Environmental Chambers
- Industrial Equipment

Ordering Information appears at end of data sheet.

Benefits and Features

- Provides High-Accuracy Thermocouple Temperature Readings
 - Includes Automatic Linearization Correction for 8 Thermocouple Types
 - $\pm 0.15\%$ (max, -20°C to +85°C) Thermocouple Full-Scale and Linearity Error
 - 19-Bit, 0.0078125°C Thermocouple Temperature Resolution
- Internal Cold-Junction Compensation Minimizes System Components
 - $\pm 0.7^\circ\text{C}$ (max, -20°C to +85°C) Cold-Junction Accuracy
- $\pm 45\text{V}$ Input Protection Provides Robust System Performance
- Simplifies System Fault Management and Troubleshooting
 - Detects Open Thermocouples
 - Over- and Undertemperature Fault Detection
- 50Hz/60Hz Noise Rejection Filtering Improves System Performance
- 14-Pin TSSOP Package

Typical Application Circuit

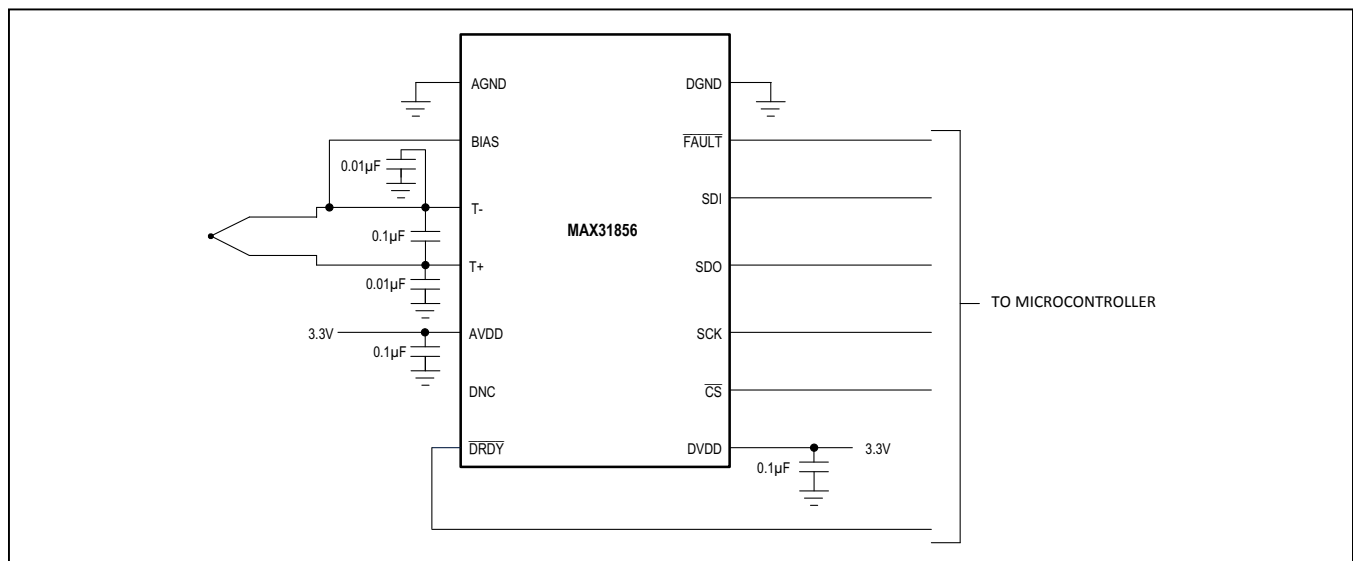

Absolute Maximum Ratings

AVDD, DVDD.....	-0.3V to +4.0V	Operating Temperature Range.....	-55°C to +125°C
T+, T-, Bias.....	±45V	Junction Temperature.....	+150°C
T+, T-, Bias.....	±20mA	Storage Temperature Range	-65°C to +150°C
All Other Pins	-0.3V to (V _{DVDD} + 0.3V)	Lead Temperature (soldering, 10s)	+300°C
Continuous Power Dissipation (T _A = +70°C)		Soldering Temperature	
TSSOP (derate 9.1mW/°C above +70°C).....	727.3mW	(reflow)	See IPC/JEDEC J-STD-020A Specification
ESD Protection (All pins, Human Body Model).....	2000V		

Stresses beyond those listed under "Absolute Maximum Ratings" may cause permanent damage to the device. These are stress ratings only, and functional operation of the device at these or any other conditions beyond those indicated in the operational sections of the specifications is not implied. Exposure to absolute maximum rating conditions for extended periods may affect device reliability.

Package Thermal Characteristics (Note 1)

TSSOP			
Junction-to-Ambient Thermal Resistance (θ _{JA})	110°C/W	Junction-to-Case Thermal Resistance (θ _{JC}).....	30°C/W

Note 1: Package thermal resistances were obtained using the method described in JEDEC specification JESD51-7, using a four-layer board. For detailed information on package thermal considerations, refer to www.maximintegrated.com/thermal-tutorial.

Recommended DC Operating Conditions

(T_A = -55°C to +125°C, unless otherwise noted.)(Notes 2 and 4)

PARAMETER	SYMBOL	CONDITIONS	MIN	TYP	MAX	UNITS
Power-Supply Voltage	V _{AVDD} , V _{DVDD}		3.0	3.3	3.6	V
AVDD-DVDD			-100		+100	mV
Cable Resistance	R _{CABLE}	Per lead			40	kΩ
Input Logic 0	V _{IL}				0.8	V
Input Logic 1	V _{IH}		2.1			V

Electrical Characteristics

(3.0V ≤ V_{DD} ≤ 3.6V, T_A = -55°C to +125°C, unless otherwise noted.)(Notes 2, 3, and 4)

PARAMETER	SYMBOL	CONDITIONS	MIN	TYP	MAX	UNITS
Supply Current	I _{DD}	Standby		5.25	10	μA
		Active conversion		1.2	2	mA
Thermocouple Temperature Resolution				19		Bits
				0.0078125		°C
Cold-Junction Temperature Data Resolution				0.015625		°C
Thermocouple Input Bias Current	I _{TCBIAS}	T _A = +25°C	-10		+10	nA
		T _A = -40°C to +85°C	-10		+65	
		T _A = -55°C to +105°C	-20		+110	
		T _A = -55°C to +125°C	-20		+400	

Electrical Characteristics (continued)(3.0V ≤ V_{DD} ≤ 3.6V, T_A = -55°C to +125°C, unless otherwise noted.)(Notes 2, 3, and 4)

PARAMETER	SYMBOL	CONDITIONS	MIN	TYP	MAX	UNITS
Thermocouple Input Differential Bias Current (Note 4)	I _{TCIDBIAS}	T _A = +25°C		±0.2		nA
		T _A = -40°C to +85°C	-4		+4	
		T _A = -55°C to +105°C	-5.5		+5.5	
		T _A = -55°C to +125°C	-10		+10	
Input-Referred Noise	V _N	AV = 8		1.3		μV _{RMS}
		AV = 32		0.4		
Power-Supply Rejection	PSR	Cold-junction sensor		0.15		°C/V
Power-On-Reset Voltage Threshold	V _{POR}			2.7	2.85	V
Power-On-Reset Voltage Hysteresis	V _{HYST}			0.1		V
Bias Voltage	V _{BIAS}			0.735		V
BIAS Output Resistance	R _{BIAS}			2		kΩ
Input Common-Mode Range			0.5		1.4	V
Full-Scale and INL Error (Note 6)		T _A = +25°C	-0.05		+0.05	%FS
		T _A = -20°C to +85°C	-0.15		+0.15	
		T _A = -40°C to +105°C	-0.2		+0.2	
		T _A = -40°C to +125°C	-0.3		+0.3	
		T _A = -55°C to +125°C	-0.35		+0.35	
Input Offset Voltage (Note 7)		T _A = +25°C	-0.01		+0.01	%FS
		T _A = -20°C to +85°C	-0.015		+0.015	
		T _A = -40°C to +105°C	-0.017		+0.017	
		T _A = -55°C to +125°C	-0.02		+0.02	
Input Offset Voltage	AV = 8	T _A = +25°C	-7.8		+7.8	μV
		T _A = -20°C to +85°C	-11.7		+11.7	
		T _A = -40°C to +105°C	-13.3		+13.3	
		T _A = -55°C to +125°C	-15.6		+15.6	
	AV = 32	T _A = +25°C	-2.0		+2.0	
		T _A = -20°C to +85°C	-2.9		+2.9	
		T _A = -40°C to +105°C	-3.3		+3.3	
		T _A = -55°C to +125°C	-3.9		+3.9	
Cold-Junction Temperature Error		T _A = -20°C to +85°C	-0.7		+0.7	°C
		T _A = -40°C to +105°C	-1		+1	
		T _A = -55°C to +125°C	-2		+2	
Overvoltage Rising Threshold (Note 8)			V _{AVDD} - 0.1	V _{AVDD} + 0.17	V _{AVDD} + 0.35	V
Overvoltage Hysteresis				0.09		V

Electrical Characteristics (continued)(3.0V ≤ V_{DD} ≤ 3.6V, T_A = -55°C to +125°C, unless otherwise noted.)(Notes 2, 3, and 4)

PARAMETER	SYMBOL	CONDITIONS	MIN	TYP	MAX	UNITS
Undervoltage Falling Edge Threshold (Note 8)			-0.3	-0.17	0	V
Undervoltage Hysteresis				0.09		V
Thermocouple Linearity Correction Error		Type B, T _A = 0 to 125°C, T _{TC} = 95°C to +1798°C	-0.24		+0.25	°C
		Type E, T _A = -55°C to +125°C T _{TC} = -200°C to +1000°C	-0.14		+0.06	
		Type J, T _A = -55°C to +125°C T _{TC} = -210°C to +1200°C	-0.11		+0.10	
		Type K, T _A = -55°C to +125°C T _{TC} = -200°C to +1372°C	-0.13		+0.12	
		Type N, T _A = -55°C to +125°C T _{TC} = -200°C to +1300°C	-0.09		+0.08	
		Type R, T _A = -50°C to +125°C T _{TC} = -50°C to +1768°C	-0.19		+0.17	
		Type S, T _A = -50°C to +125°C T _{TC} = -50°C to +1768°C	-0.16		+0.20	
		Type T, T _A = -55°C to +125°C T _{TC} = -200°C to +400°C	-0.07		+0.07	
Temperature Conversion Time (Thermocouple + Cold Junction)	t _{CONV}	1-Shot conversion or first conversion in auto-conversion mode (60Hz)		143	155	ms
		1-Shot conversion or first conversion in auto-conversion mode (50Hz)		169	185	
		Auto conversion mode, conversions 2 through n (60Hz)		82	90	
		Auto conversion mode, conversions 2 through n (50Hz)		98	110	

Electrical Characteristics (continued)(3.0V ≤ V_{DD} ≤ 3.6V, T_A = -55°C to +125°C, unless otherwise noted.)(Notes 2, 3, and 4)

PARAMETER	SYMBOL	CONDITIONS	MIN	TYP	MAX	UNITS
Common-Mode Rejection	CMR	0.5V ≤ V _{CM} ≤ 1.4V		70		dB
50/60Hz Noise Rejection		Fundamental and harmonics		91		dB
SERIAL INTERFACE						
Input Leakage Current	I _{LEAK}	(Note 5)	-1		+1	μA
Output High Voltage	V _{OH}	I _{OUT} = -1.6mA	V _{CC} - 0.4			V
Output Low Voltage	V _{OL}	I _{OUT} = 1.6mA			0.4	V
Input Capacitance	C _{IN}			8		pF
Serial Clock Frequency	f _{SCL}				5	MHz
SCK Pulse High Width	t _{CH}		100			ns
SCK Pulse Low Width	t _{CL}		100			ns
SCK Rise and Fall Time	t _R , t _F	C _L = 10pF			200	ns
$\overline{\text{CS}}$ Fall to SCK Rise	t _{CC}	C _L = 10pF	100			ns
SCK to $\overline{\text{CS}}$ Hold	t _{CCH}	C _L = 10pF	100			ns
$\overline{\text{CS}}$ Rise to Output Disable	t _{CDZ}	C _L = 10pF			40	ns
Data to SCLK Setup	t _{DC}		35			ns
SCLK to Data Hold	t _{CDH}		35			ns
SCK Fall to Output Data Valid	t _{CDD}	C _L = 10pF			80	ns
$\overline{\text{CS}}$ Inactive Time	t _{CWH}	(Note 3)	400			ns

Note 2: All voltages are referenced to GND. Currents entering the IC are specified positive, and currents exiting the IC are negative.**Note 3:** All Serial Interface timing specifications are guaranteed by design.**Note 4:** Specification is 100% tested at T_A = +25°C. Specification limits over temperature (T_A = T_{MIN} to T_{MAX}) are guaranteed by design and characterization; not production tested.**Note 5:** For all pins except T+ and T- (see the Thermocouple Input Bias Current parameter in the [Electrical Characteristics](#) table).**Note 6:** Using a common-mode voltage other than V_{BIAS} will change this specification. See the [Typical Operating Characteristics](#) for details.**Note 7:** Input-referred full-scale voltage is 78.125mV when AV = 8 and is 19.531mV when AV = 32.**Note 8:** Overvoltage and undervoltage limits apply to T+, T-, and BIAS pins.

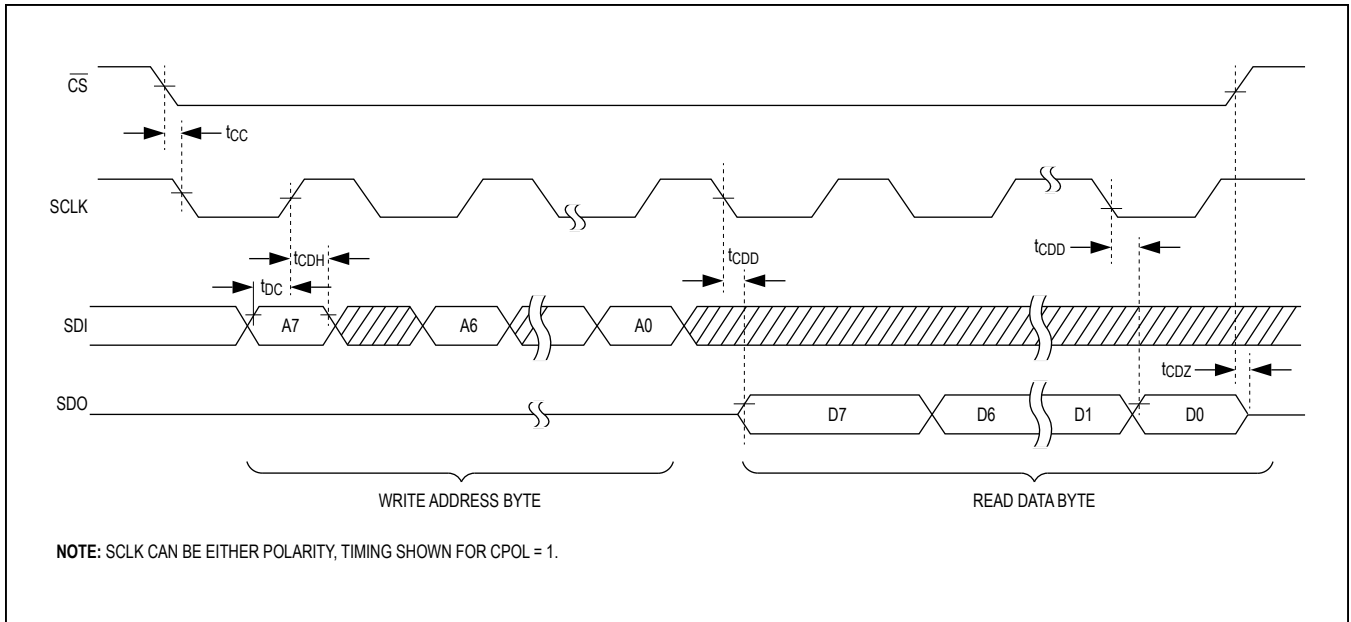

Figure 1. Timing Diagram: SPI Read Data Transfer

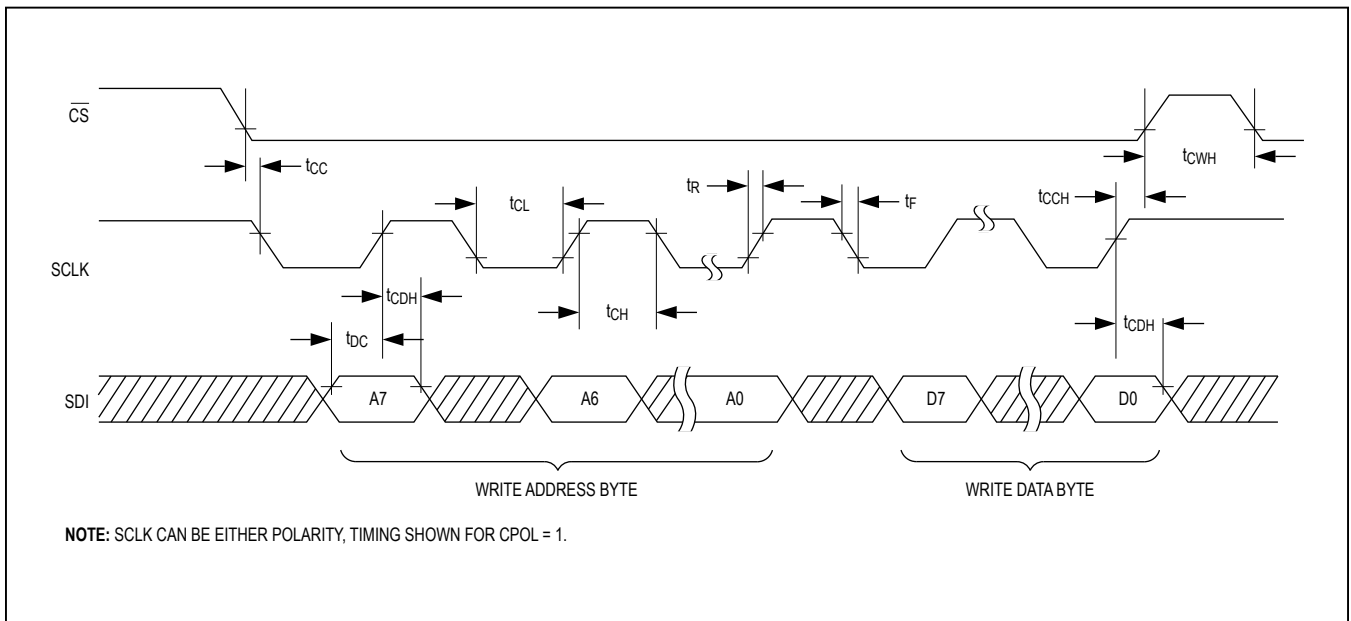
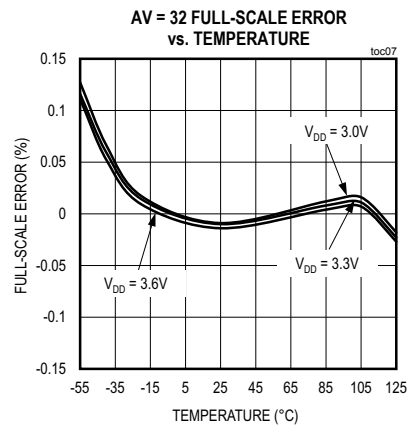
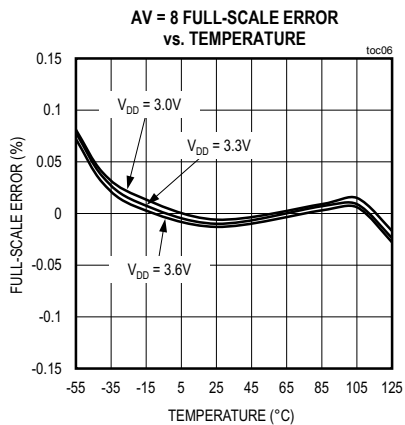
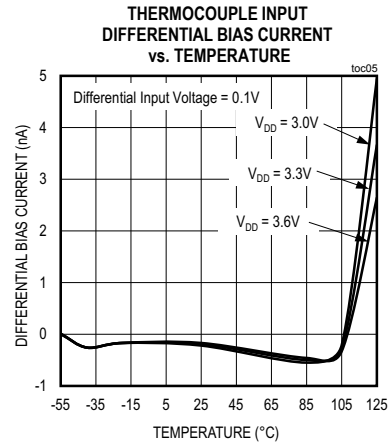
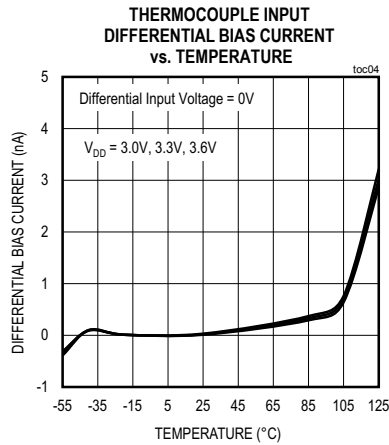
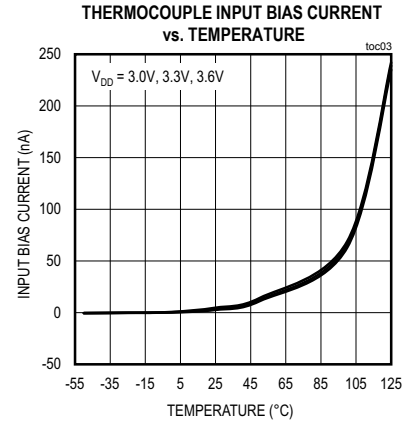
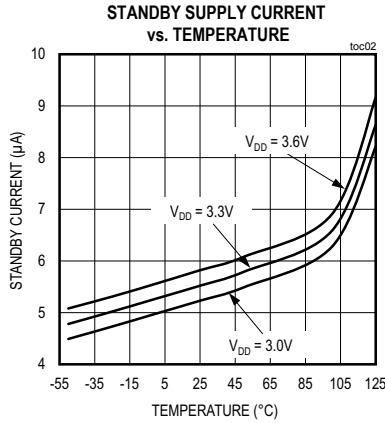
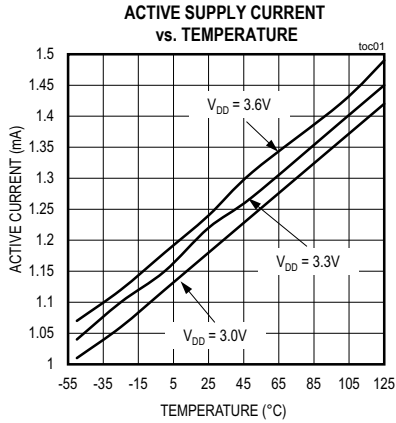

Figure 2. Timing Diagram: SPI Write Data Transfer

Typical Operating Characteristics

($V_{CC} = 3.3V$ and $T_A = +25^\circ C$, unless otherwise noted.)



Typical Operating Characteristics (continued)

($V_{CC} = 3.3V$ and $T_A = +25^{\circ}C$, unless otherwise noted.)

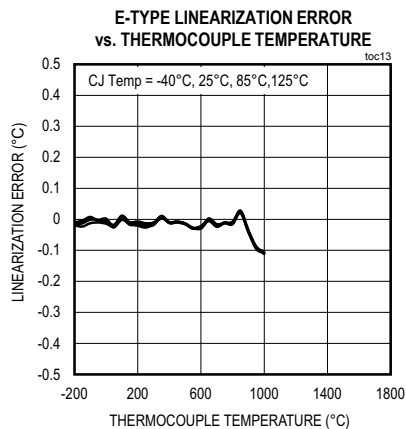
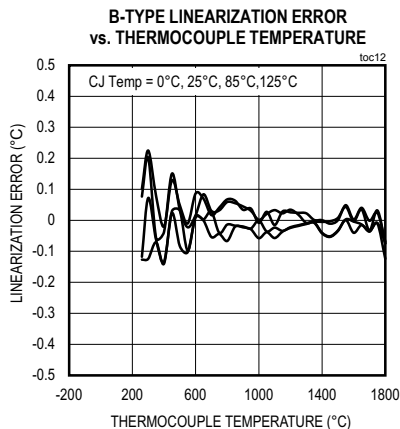
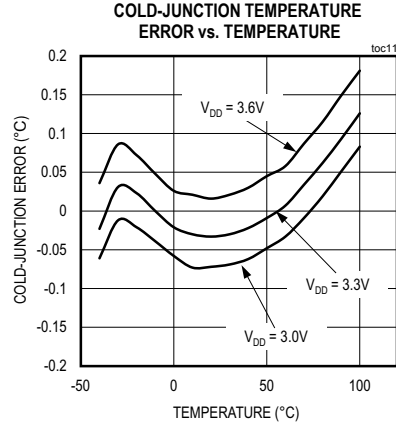
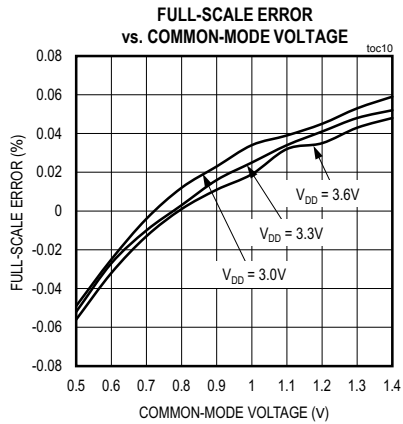
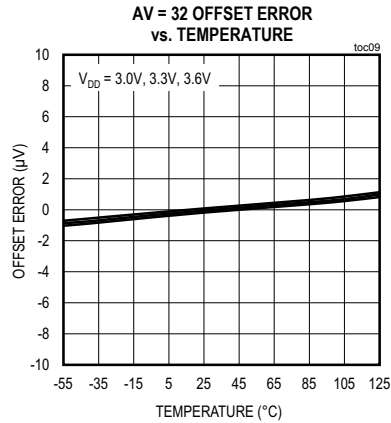
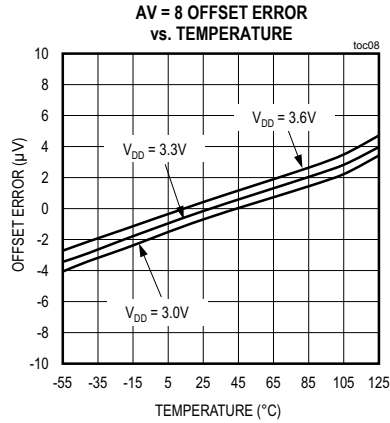

Typical Operating Characteristics (continued)

($V_{CC} = 3.3V$ and $T_A = +25^\circ C$, unless otherwise noted.)

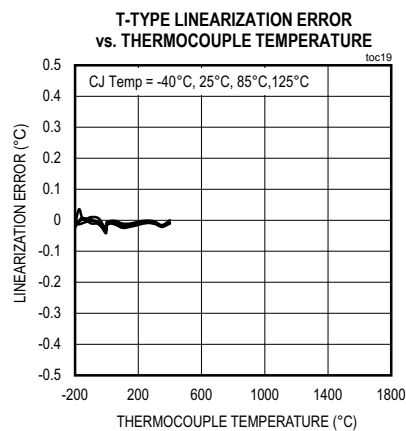
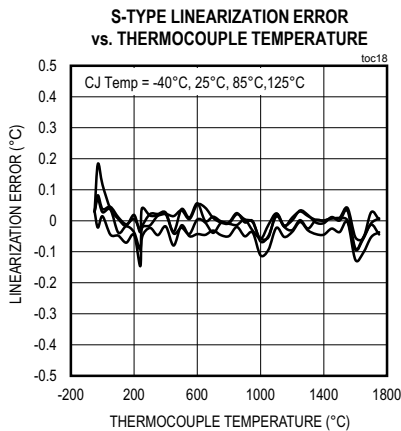
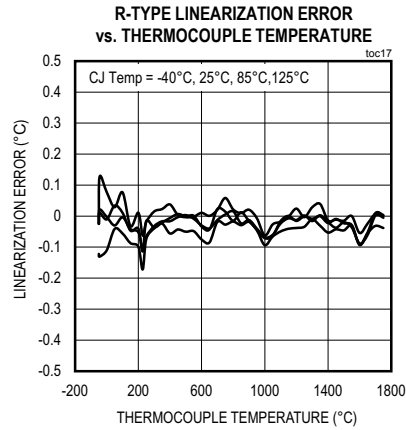
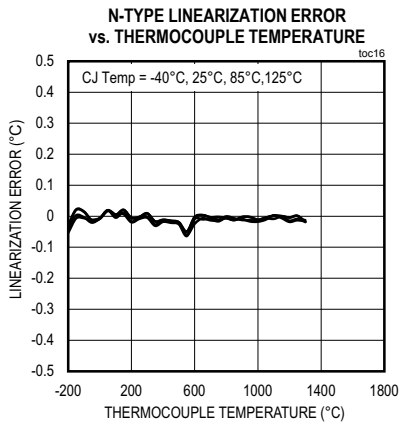
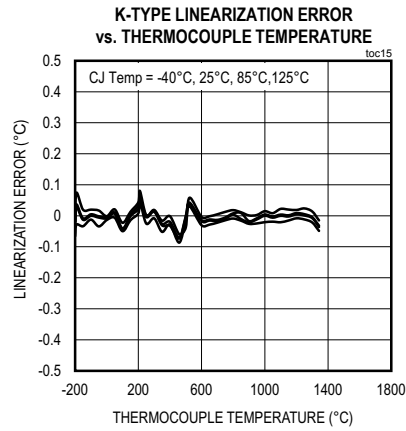
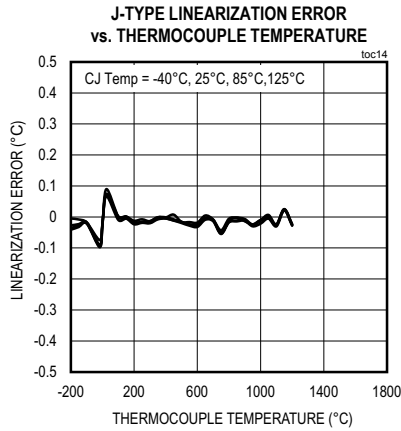

Pin Configuration

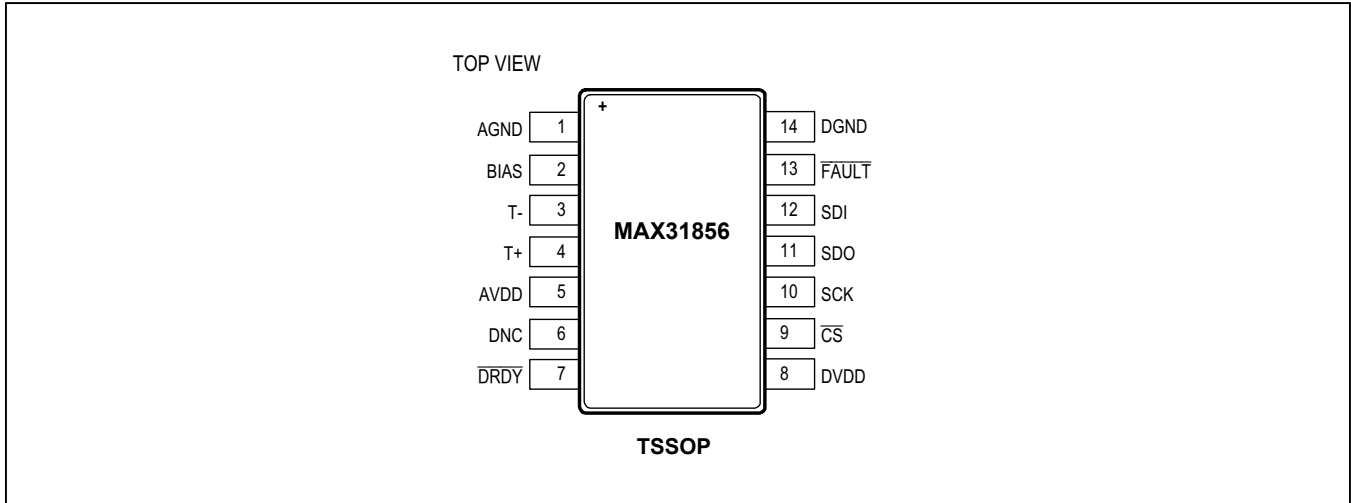

Pin Description

PIN	NAME	FUNCTION
1	AGND	Analog Ground
2	BIAS	Bias Voltage Source. Nominally 0.735V. This pin is floating when no conversions are taking place.
3	T-	Thermocouple Negative Input. See Table 1 .
4	T+	Thermocouple Positive Input. See Table 1 .
5	AVDD	Analog Positive Supply. Bypass with a 0.1µF capacitor to AGND.
6	DNC	Do Not Connect
7	$\overline{\text{DRDY}}$	Data Ready Output
8	DVDD	Digital Positive Supply. Bypass with a 0.1µF capacitor to DGND.
9	$\overline{\text{CS}}$	Chip Select. Set $\overline{\text{CS}}$ low to enable the serial interface.
10	SCK	Serial Clock Input
11	SDO	Serial Data Output
12	SDI	Serial Data Input
13	$\overline{\text{FAULT}}$	Cable, thermocouple, or temperature fault output
14	DGND	Digital Ground

Block Diagram

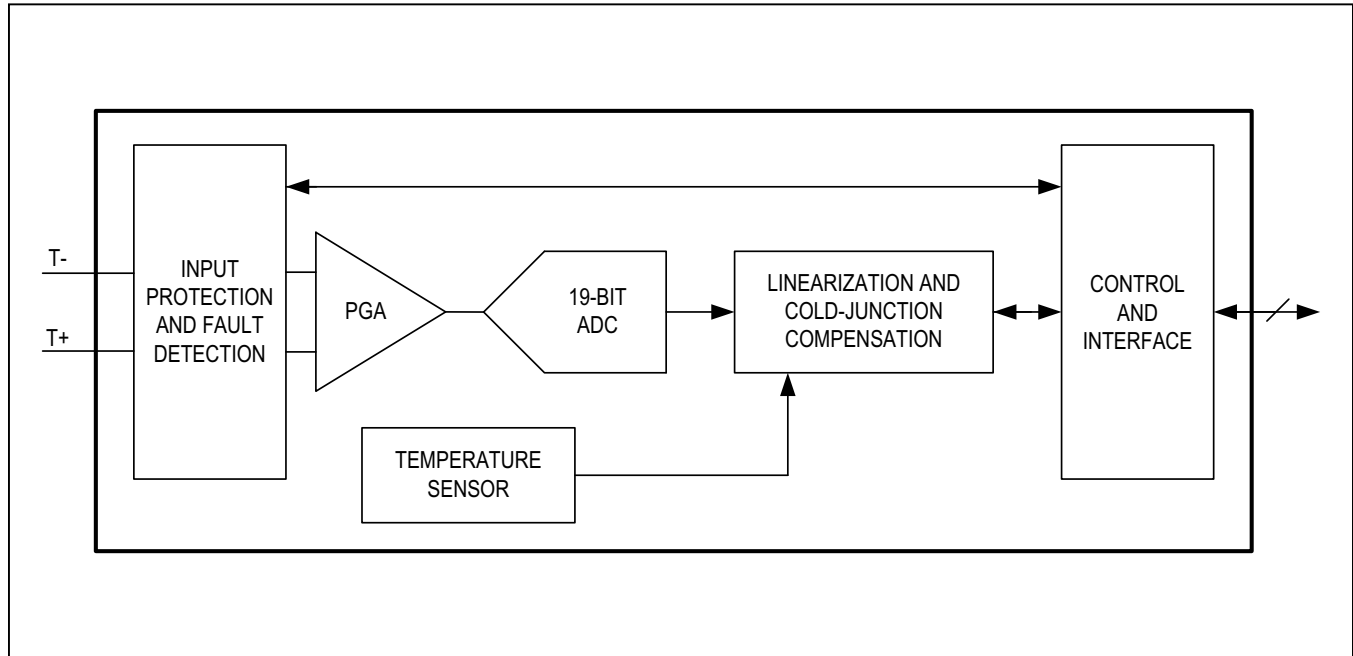

Detailed Description

The MAX31856 is a sophisticated thermocouple-to-digital converter with a built-in 19-bit analog-to-digital converter (ADC). Internal functions include correction for thermocouple nonlinearity, input protection, cold-junction compensation sensing and correction, a digital controller, a SPI-compatible interface, and associated control logic.

In the simplest configuration, the thermocouple wires connect directly to inputs T- and T+, with a common-mode bias voltage provided by the BIAS output. Additional filtering and/or protection components may be added if needed, as discussed in the [Applications Information](#) section. Operation is controlled by two configuration bytes and four bytes that contain over- and undertemperature detection thresholds.

Temperature Conversion

The temperature conversion process consists of five steps as described in the sections below. The input amplifier and ADC amplify and digitize the thermocouple's voltage output. The internal temperature sensor measures the cold-junction temperature. Using the internal lookup table (LUT), the ADC code corresponding to the cold-junction temperature for the selected thermocouple type is determined. The thermocouple code and the cold-junc-

tion code are summed to produce the code corresponding to the cold-junction compensated thermocouple temperature. Finally, the LUT is used to produce a cold-junction compensated output code in units of °C.

Thermocouple Voltage Conversion

T+ and T- are the thermocouple inputs. T- is biased to approximately 0.735V by the BIAS output. The amplifier provides gain to the μV - and mV -level thermocouple signals to make the amplitude appropriate for the ADC's full-scale input range. Two amplifier gains provide full-scale input ranges of $\pm 78.125\text{mV}$ and $\pm 19.531\text{mV}$ to accommodate higher- and lower-sensitivity thermocouples.

Because long thermocouple wires may pick up noise from a variety of sources, including AC power cables, the amplified signal is lowpass filtered before being applied to the ADC. The ADC provides further digital lowpass and notch filtering to attenuate input noise. The notch frequencies are either 50Hz and its harmonics or 60Hz and its harmonics, selectable using bit 0 of the Configuration 0 register (00h). In addition, bits D6:4 of the Configuration 1 register (01h) enable an averaging mode that provides additional filtering with an associated increase in conversion time. 2, 4, 8, or 16 samples may be averaged using this mode.

The conversion mode can be either continuous or “normally off”, as selected by bit 7 of the Configuration 0 register (00h). When in the normally off mode, a single “1-shot” conversion may be selected using bit 6 of the Configuration 0 register (00h).

Thermocouple type is user-selectable using bits D3:0 of the Configuration 1 register (01h). Thermocouple types K, J, N, R, S, T, B, and E are supported by automatic cold-junction compensation and linearization. (To use a different thermocouple type, use bits D3:0 to select a gain of either 8 or 32. The linearization and cold-junction compensation calculations may then be done externally using the cold-junction temperature and thermocouple voltage data.)

Cold-Junction Temperature Sensing

The function of the thermocouple is to sense a difference in temperature between two ends of the thermocouple wires. The thermocouple’s sensing junction (often called the “hot” junction regardless of its temperature) can be measured across its rated operating temperature range (see [Table 1](#) for supported thermocouple temperature ranges).

Additional thermocouples are created where the thermocouple wires make contact with different metals, usually at a connector or at the point where they are soldered to a PCB (the “cold junction”). To compensate for the errors due to these additional thermocouples, the temperature at

the cold junction must be measured. This is done with the internal precision temperature sensor, which has accuracy better than $\pm 0.7^{\circ}\text{C}$ from -20°C to $+85^{\circ}\text{C}$. By placing the MAX31856 near the cold junction, the cold-junction temperature can be measured and used to compensate for cold-junction effects.

The MAX31856 stores the cold-junction temperature data in registers 0Ah and 0Bh. When the cold-junction temperature sensor is enabled, these registers are read-only and contain the measured cold-junction temperature plus the value in the Cold-Junction Offset register. Reading the register with the cold-junction temperature sensor enabled will reset the $\overline{\text{DRDY}}$ pin high. Both bytes of this register should be read as a multibyte transfer to ensure both bytes are from the same temperature update. When the cold-junction temperature sensor is disabled, these registers become read-write registers that contain the most recent measured temperature value. If desired, data from an external temperature sensor may be written to these registers when the internal cold-junction sensor is disabled. The maximum cold-junction temperature is clamped at 128°C and the minimum is clamped at -64°C . See [Table 2](#) for the Reference Junction (Cold Junction) Temperature Data Format.

If desired, a temperature offset may be written to the Cold-Junction Offset register (09h). The value stored in registers 0Ah and 0Bh will then be equal to the measured

Table 1. Supported Thermocouples and Temperature Ranges

TYPE	T-WIRE	T+ WIRE	TEMP RANGE	NOMINAL SENSITIVITY ($\mu\text{V}/^{\circ}\text{C}$)	COLD-JUNCTION TEMP RANGE
B	Platinum/Rhodium	Platinum/Rhodium	250°C to 1820°C	10.086 ($+500^{\circ}\text{C}$ to $+1500^{\circ}\text{C}$)	0 to 125°C
E	Constantan	Chromel	-200°C to $+1000^{\circ}\text{C}$	76.373 (0°C to $+1000^{\circ}\text{C}$)	-55°C to $+125^{\circ}\text{C}$
J	Constantan	Iron	-210°C to $+1200^{\circ}\text{C}$	57.953 (0°C to $+750^{\circ}\text{C}$)	-55°C to $+125^{\circ}\text{C}$
K	Alumel	Chromel	-200°C to $+1372^{\circ}\text{C}$	41.276 (0°C to $+1000^{\circ}\text{C}$)	-55°C to $+125^{\circ}\text{C}$
N	Nisil	Nicrosil	-200°C to $+1300^{\circ}\text{C}$	36.256 (0°C to $+1000^{\circ}\text{C}$)	-55°C to $+125^{\circ}\text{C}$
R	Platinum	Platinum/Rhodium	-50°C to $+1768^{\circ}\text{C}$	10.506 (0°C to $+1000^{\circ}\text{C}$)	-50°C to $+125^{\circ}\text{C}$
S	Platinum	Platinum/Rhodium	-50°C to $+1768^{\circ}\text{C}$	9.587 (0°C to $+1000^{\circ}\text{C}$)	-50°C to $+125^{\circ}\text{C}$
T	Constantan	Copper	-200°C to $+400^{\circ}\text{C}$	52.18 (0°C to $+400^{\circ}\text{C}$)	-55°C to $+125^{\circ}\text{C}$

value plus the offset value. The MSB of the offset register is 4°C and the LSB is 0.0625°C. The resulting range of the offset value applied to the measured CJ temperature is -8°C to +7.9375°C. The default offset value is 0°C (00h).

Optimal performance is achieved when the thermocouple cold junction and the cold-junction sensor are at the same temperature. Avoid placing heat-generating devices or components near the cold junction because this may produce cold-junction-related errors. When a significant temperature differential between the internal sensor and the cold junction is unavoidable, an external temperature sensor may be used instead. The temperature measured by the external sensor may be written to the cold-junction temperature register and used for cold-junction compensation. Bit 3 of Configuration 0 register (00h) disables the internal cold-junction temperature sensor and allows temperature values from an external sensor to be written directly into the Cold-Junction Temperature registers (0Ah and 0Bh).

Cold-Junction Temperature Translation and Compensation

Thermocouple temperature values and corresponding ADC codes are stored in an internal lookup table. After measuring the cold-junction temperature, the LUT is used to convert the temperature value to the equivalent ADC code for the type of thermocouple being used. Values between LUT entries are interpolated. The cold-junction ADC code is added to the conversion result in the thermocouple voltage register to yield a cold-junction-compensated value.

Table 2. Reference Junction (Cold-Junction) Temperature Data Format

TEMPERATURE (°C)	DIGITAL OUTPUT
+127.984375	0111 1111 1111 1100
+127	0111 1111 0000 0000
+125	0111 1101 0000 0000
+64	0100 0000 0000 0000
+25	0001 1001 0000 0000
+0.5	0000 0000 1000 0000
+0.015625	0000 0000 0000 0100
0	0000 0000 0000 0000
-0.5	1111 1111 1000 0000
-25	1110 0111 0000 0000
-55	1100 1001 0000 0000

Thermocouple Linearization and Conversion of Code to Temperature

Because all thermocouples are nonlinear, the raw cold-junction-compensated value must be corrected for non-linearity and converted to a temperature value. This is done using the LUT to produce the linearized and cold-junction-compensated temperature value, which is stored after every conversion as 19 bits in the Linearized Thermocouple Temperature registers (0Ch, 0Dh, and 0Eh). All three bytes should be read as a multibyte transfer to ensure all are from the same data update. See [Table 3](#) for the Linearized Thermocouple Temperature Data Format.

Linearization accuracy varies by thermocouple type, “hot-junction” temperature, and cold-junction temperature, with the largest errors typically occurring near the hot-junction and cold-junction extremes. Worst-case values for linearization errors are shown in the [Electrical Characteristics](#) table.

Over-/Undertemperature Fault Detection

Over- and undertemperature fault detection are available for both the cold-junction temperature and the linearized and cold-junction-compensated temperature reading. Two registers (03h and 04h) contain the high and low thresholds for the cold-junction temperature. The cold-junction temperature value in registers 0Ah and 0Bh is compared to the threshold values. If a threshold is exceeded, the corresponding bit is set in the Fault Status register (0Fh) and, if not masked, the $\overline{\text{FAULT}}$ output will assert.

Table 3. Linearized Thermocouple Temperature Data Format

TEMPERATURE (°C)	DIGITAL OUTPUT
+1600.00	0110 0100 0000 0000 0000 0000
+1000.00	0011 1110 1000 0000 0000 0000
+100.9375	0000 0110 0100 1111 0000 0000
+25.00	0000 0001 1001 0000 0000 0000
+0.0625	0000 0000 0000 0001 0000 0000
0.00	0000 0000 0000 0000 0000 0000
-0.0625	1111 1111 1111 1111 0000 0000
-0.25	1111 1111 1111 1100 0000 0000
-1.00	1111 1111 1111 0000 0000 0000
-250.00	1111 0000 0110 0000 0000 0000

This format also applies to the High Fault and Low Fault thresholds.

(Note that the practical temperature range varies with the thermocouple type.)

Four registers (05h through 08h) contain over- and under-temperature thresholds for the linearized and cold-junction-compensated temperature. These threshold register values are compared to the linearized temperature reading found in registers 0Ch, 0Dh, and 0Eh. If a threshold is exceeded, the corresponding bit is set in the Fault Status register (0Fh) and, if not masked, the $\overline{\text{FAULT}}$ output will assert.

Integrated Input Protection

The internal circuitry is protected from excessive voltages applied to the thermocouple cables by integrated MOSFETs at the T+ and T- inputs, and the BIAS output. These MOSFETs turn off when the input voltage is negative or greater than V_{DD} . The MOSFETs are capable of withstanding input voltages up to $\pm 45V$. If fault voltages beyond the $\pm 45V$ limits are expected, see the [Applications Information](#) section.

When the absolute input voltage at T+ or T- is negative or greater than V_{DD} , the Under-/Overvoltage Fault bit, Bit 1, is set in the Fault Status register (0Fh) and the $\overline{\text{FAULT}}$ pin asserts if not masked. Conversions are suspended while the OVUV fault is present and will resume when the fault is removed.

Open-Circuit Fault Detection

Detection of open-circuit faults, such as those caused by broken thermocouple wires, can be enabled or disabled using bits 4 and 5 in the Configuration 0 register (00h). Fault detection is accomplished by forcing a small

current through the thermocouple wires. The time required to detect an open circuit depends on the values of the lead resistances and any filter capacitance at the thermocouple input and therefore, bits 4 and 5 also select the time allowed for open-circuit fault detection. A nominal detection time of either 10ms, 32ms, or 100ms can be selected. The Open-Circuit Detection Mode table ([Table 4](#)) shows the effect of these two bits on the conversion time. When the device is in one-shot mode, open-circuit detection can be disabled or set to occur every one-shot conversion. When the device is in automatic conversion mode, open-circuit detection may be disabled, or it may be set to automatically test for open circuits every 16 conversion cycles. If on-demand detection is desired, select “detection disabled” (00), then select the setting for the desired time constant. An open-circuit detection test will be performed immediately after the current conversion is completed. Disabling the open fault detection when in comparator mode while there is an open fault present will not clear the fault bit or $\overline{\text{FAULT}}$ pin. If this happens, to subsequently clear the fault, the MAX31856 must be placed in interrupt mode and then the fault cleared. Note that, when cold-junction sensing is enabled, open-circuit fault detection and cold-junction sensing occur concurrently. Therefore, cold-junction temperature sensing has no effect on the overall cycle time when open-circuit fault detection is enabled. An open-circuit fault is indicated by the Open Fault bit, Bit 0, in the Fault Status register (0Fh) and the $\overline{\text{FAULT}}$ pin asserts if not masked.

Table 4. Open-Circuit Detection Mode

BITS 5:4 OCFAULT1: OCFAULT0 (Config Byte 0)	FAULT TEST	INPUT NETWORK	FAULT TEST TIME (ms)			
			CJ SENSE ENABLED		CJ SENSE DISABLED	
			TYP	MAX	TYP	MAX
00	Disabled	N/A	0	0	0	0
01	Enabled (Once every 16 conversions)	$R_S < 5k\Omega$	13.3	15	40	44
10	Enabled (Once every 16 conversions)	$40k\Omega > R_S > 5k\Omega$; Time constant < 2ms	33.4	37	60	66
11	Enabled (Once every 16 conversions)	$40k\Omega > R_S > 5k\Omega$; Time constant > 2ms	113.4	125	140	154

Cold-Junction and Thermocouple Out-of-Range Detection

Thermocouple characteristics, the measurement circuitry, and the linearization calculations limit the optimum temperature ranges for both the cold junction and the measurement junction (“hot junction”). Bit D7 of the Fault Status register indicates when the cold-junction temperature falls outside of the optimum range, and bit D6 indicates when the hot-junction temperature is out of range. [Table 1](#) shows the temperature limits that apply for the supported thermocouple types. These values are rounded to the nearest °C. When the temperature falls outside of the limit for a given measurement, the reported thermocouple temperature is clamped at the limit value. Note that the $\overline{\text{FAULT}}$ pin never asserts for an out-of-range fault.

Serial Interface

Four pins are used for SPI-compatible communications: SDO (serial-data out), SDI (serial-data in), $\overline{\text{CS}}$ (chip select), and SCLK (serial clock). SDI and SDO are the serial-data input and output pins, respectively. The $\overline{\text{CS}}$ input initiates and terminates a data transfer. SCLK synchronizes data movement between the master (microcontroller) and the slave (MAX31856).

The serial clock (SCLK), which is generated by the microcontroller, is active only when $\overline{\text{CS}}$ is low and during address and data transfer to any device on the SPI bus. The inactive clock polarity is programmable in some microcontrollers. The MAX31856 automatically accommodates either clock polarity by sampling SCLK when $\overline{\text{CS}}$ becomes active to determine the polarity of the inactive clock. Input data (SDI) is latched on the internal strobe edge and output data (SDO) is shifted out on the shift

edge (see [Table 5](#) and [Figure 3](#)). There is one clock for each bit transferred. Address and data bits are transferred in groups of eight, MSB first.

Address and Data Bytes

Address and data bytes are shifted MSB-first into the serial-data input (SDI) and out of the serial-data output (SDO). Any transfer requires the address of the byte to specify a write or a read, followed by one or more bytes of data. Data is transferred out of the SDO for a read operation and into the SDI for a write operation. The address byte is always the first byte transferred after $\overline{\text{CS}}$ is driven low. The MSB (A7) of this byte determines whether the following byte will be written or read. If A7 is 0, one or more byte reads will follow the address byte. If A7 is 1, one or more byte writes will follow the address byte.

For a single-byte transfer, 1 byte is read or written and then $\overline{\text{CS}}$ is driven high (see [Figure 4](#) and [Figure 5](#)). For a multiple-byte transfer, multiple bytes can be read or written after the address has been written (see [Figure 6](#)). The address continues to increment through all memory locations as long as $\overline{\text{CS}}$ remains low. If data continues to be clocked in or out, the address will loop from 7Fh/FFh to 00h/80h. Invalid memory addresses report an FFh value. Attempting to write to a read-only register will result in no change to that register’s contents.

$\overline{\text{DRDY}}$

The $\overline{\text{DRDY}}$ output goes low when a new conversion result is available in the Linearized Thermocouple Temperature register. When a read-operation of the Linearized Thermocouple Temperature register or the Cold-Junction Temperature Register (if enabled) completes, $\overline{\text{DRDY}}$ returns high.

Table 5. Serial Interface Function

MODE	$\overline{\text{CS}}$	SCLK	SDI	SDO
Disable Reset	High	Input Disabled	Input disabled	High impedance
Write	Low	CPOL = 1*, SCLK rising	Data bit latch	High impedance
		CPOL = 0, SCLK falling		
Read	Low	CPOL = 1, SCLK falling	X	Next data bit shift**
		CPOL = 0, SCLK rising		

Note: CPHA bit polarity must be set to 1.

*CPOL is the clock polarity bit that is set in the control register of the microcontroller.

**SDO remains at high impedance until 8 bits of data are ready to be shifted out during a read.

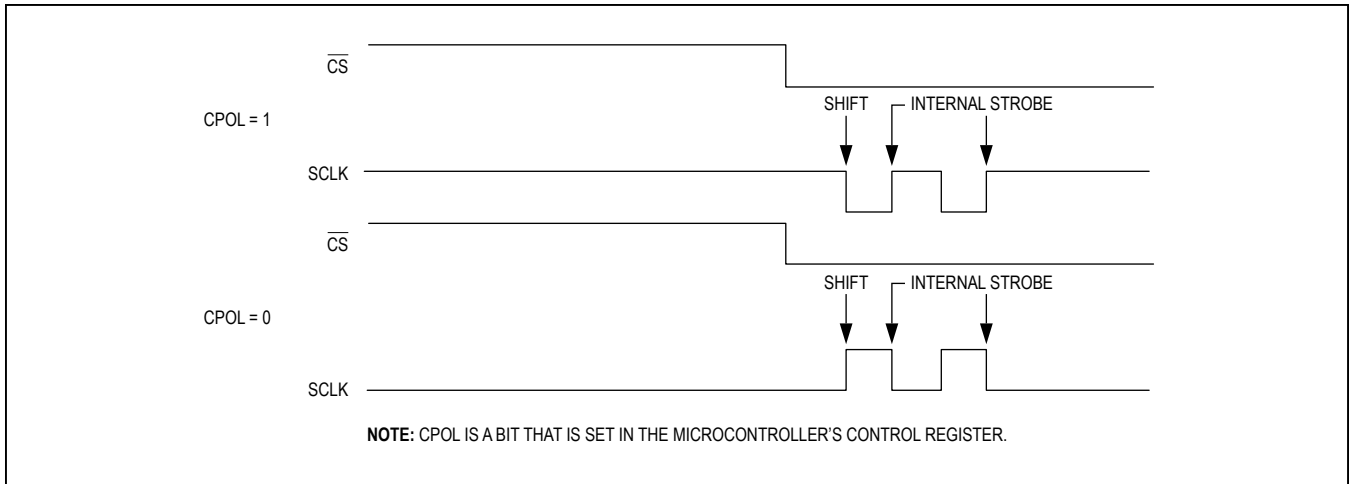

Figure 3. Serial Clock as a Function of Microcontroller Clock Polarity (CPOL)

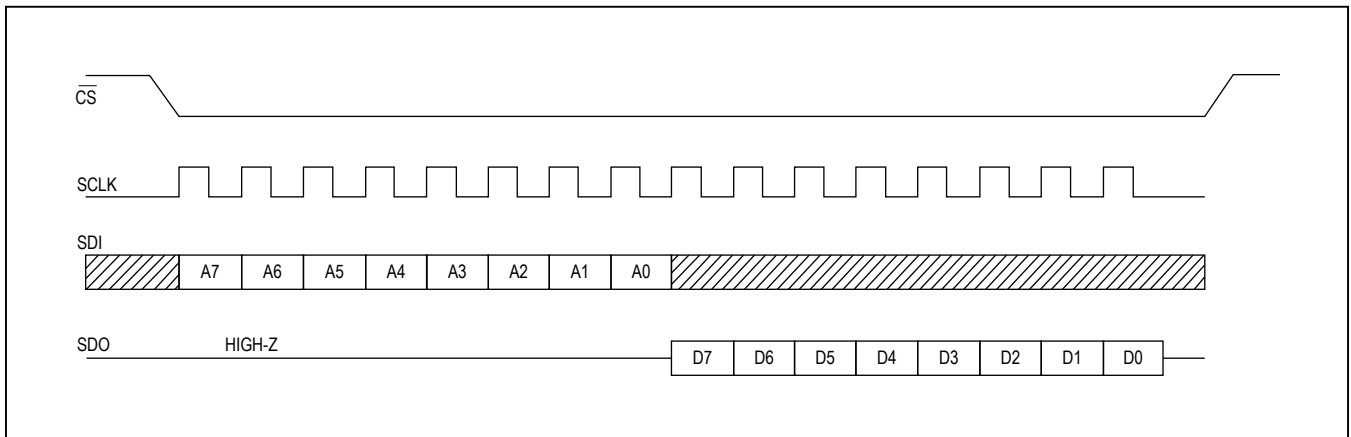

Figure 4. SPI Single-Byte Read

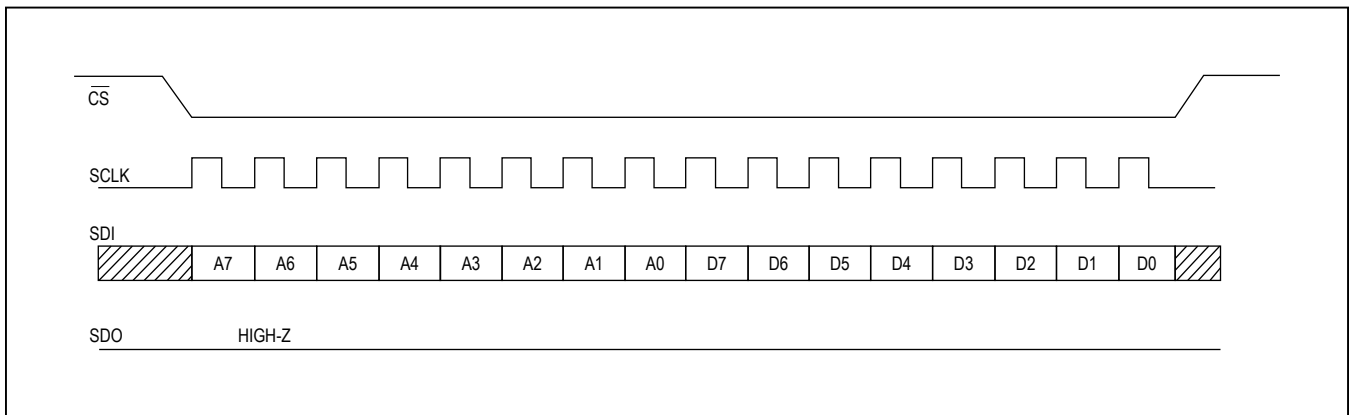

Figure 5. SPI Single-Byte Write

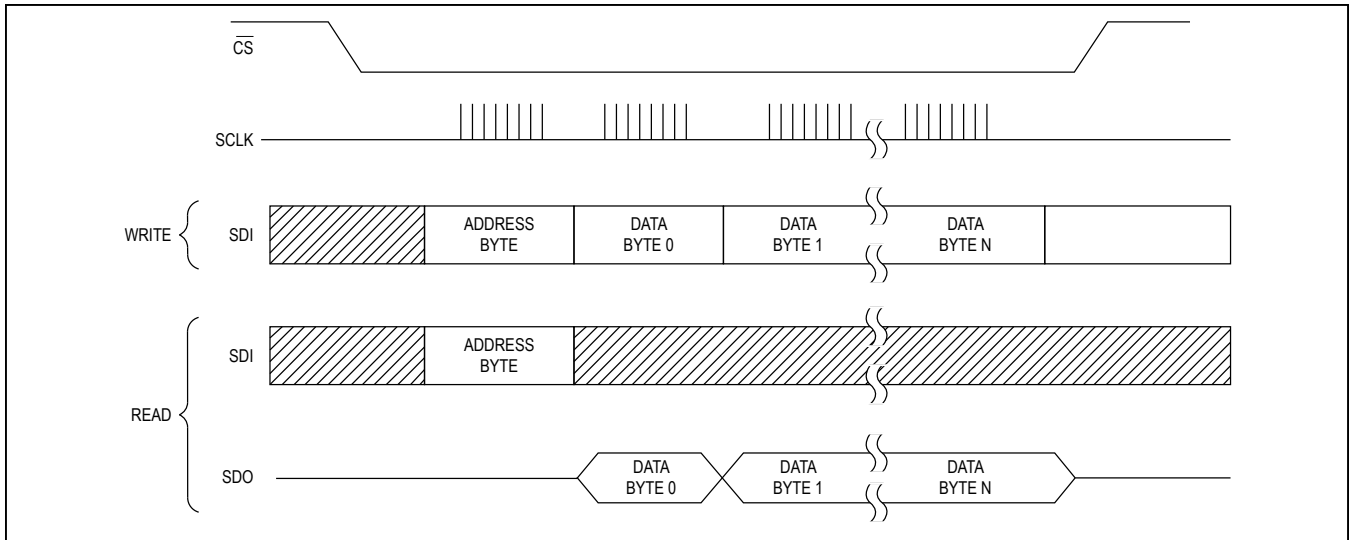

Figure 6. SPI Multibyte Transfer

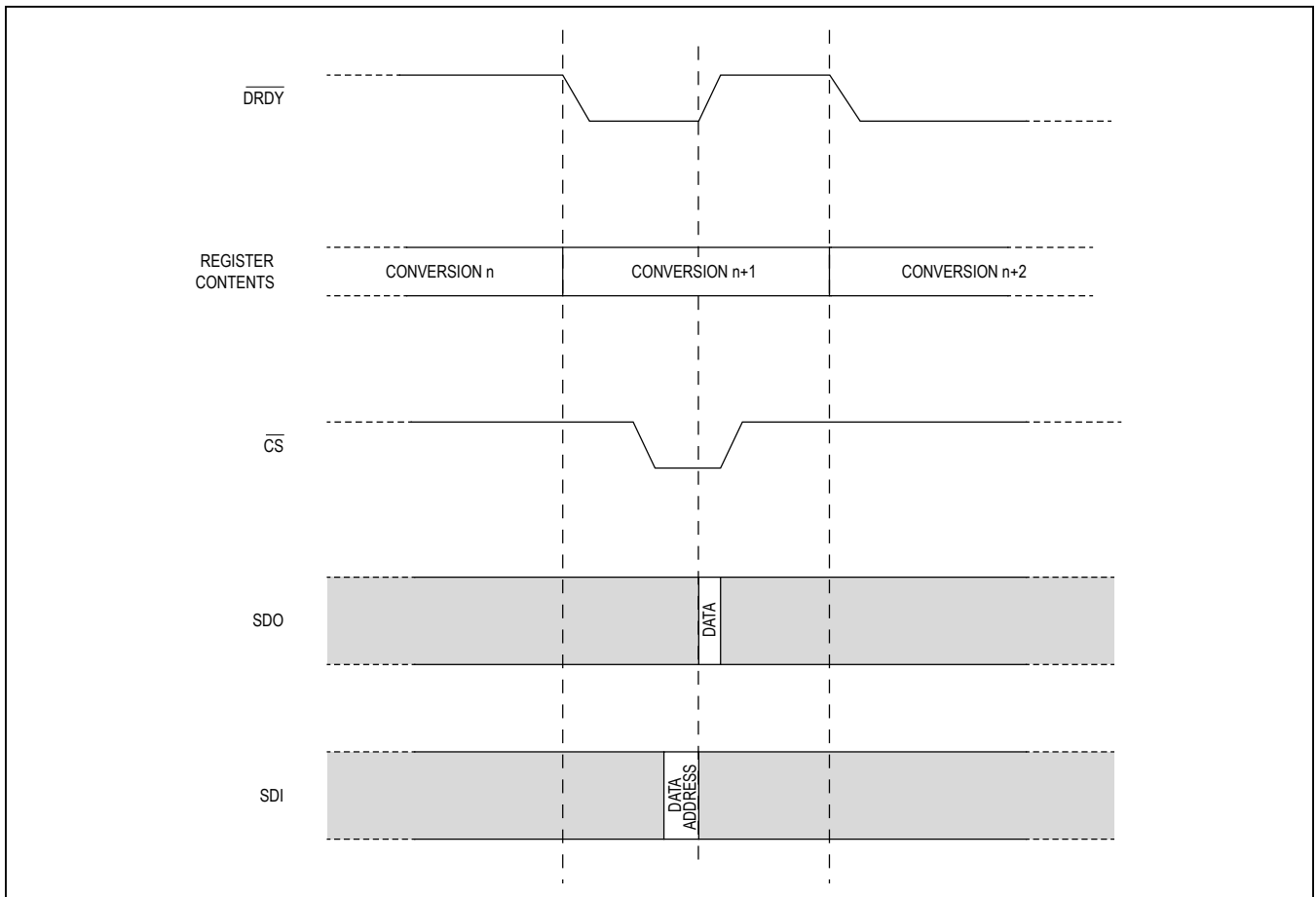

Figure 7. \overline{DRDY} Operation

Internal Registers

Communication with the MAX31856 is accomplished through 16 8-bit registers that contain conversion, status, and configuration data. All programming is done by selecting the appropriate address of the desired register location. The Register Memory Map (Table 6) illustrates the addresses for the temperature, status, and configuration registers.

The registers are accessed using the 0Xh addresses for reads and the 8Xh addresses for writes. Data is read from or written to the registers MSB first. Attempts to write to a read-only register results in no change in the data.

Table 6. Register Memory Map

ADDRESS	READ/WRITE	NAME	FACTORY DEFAULT	FUNCTION
00h/80h	Read/Write	CR0	00h	Configuration 0 Register
01h/81h	Read/Write	CR1	03h	Configuration 1 Register
02h/82h	Read/Write	MASK	FFh	Fault Mask Register
03h/83h	Read/Write	CJHF	7Fh	Cold-Junction High Fault Threshold
04h/84h	Read/Write	CJLF	C0h	Cold-Junction Low Fault Threshold
05h/85h	Read/Write	LTHFTH	7Fh	Linearized Temperature High Fault Threshold MSB
06h/86h	Read/Write	LTHFTL	FFh	Linearized Temperature High Fault Threshold LSB
07h/87h	Read/Write	LTLFTH	80h	Linearized Temperature Low Fault Threshold MSB
08h/88h	Read/Write	LTLFTL	00h	Linearized Temperature Low Fault Threshold LSB
09h/89h	Read/Write	CJTO	00h	Cold-Junction Temperature Offset Register
0Ah/8Ah	Read/Write	CJTH	00h	Cold-Junction Temperature Register, MSB
0Bh/8Bh	Read/Write	CJTL	00h	Cold-Junction Temperature Register, LSB
0Ch	Read Only	LTCBH	00h	Linearized TC Temperature, Byte 2
0Dh	Read Only	LTCBM	00h	Linearized TC Temperature, Byte 1
0Eh	Read Only	LTCBL	00h	Linearized TC Temperature, Byte 0
0Fh	Read Only	SR	00h	Fault Status Register

Register 00h/80h: Configuration 0 Register (CR0)

The Configuration 0 register selects the conversion mode (automatic or triggered by the 1-shot command), selects open-circuit fault detection timing, enables the cold-junction sensor, clears the fault status register, and selects the filter notch frequencies. The effects of the configuration bits are described below.

Default Value: 00h

MEMORY ACCESS	R/W	R/W	R/W	R/W	R/W	R/W	R/W	R/W
00h/80h	CMODE	1SHOT	OCFAULT1	OCFAULT0	CJ	FAULT	FAULTCLR	50/60Hz
	Bit 7			Bit 0				

Register 00h/80h: Configuration 0 Register (CR0) (continued)

BIT	NAME	DESCRIPTION
7	CMODE	Conversion Mode 0 = Normally Off mode (default) 1 = Automatic Conversion mode. Conversions occur continuously every 100ms (nominal).
6	1SHOT	One-Shot Mode 0 = No conversions requested (default) 1 = This causes a single cold-junction and thermocouple conversion to take place when Conversion Mode bit =0 (normally off mode). The conversion is triggered when \overline{CS} goes high after writing a 1 to this bit. Note that if a multi-byte write is performed, the conversion is triggered when \overline{CS} goes high at the end of the transaction. A single conversion requires approximately 143ms in 60Hz filter mode or 169ms in 50Hz filter mode to complete. This bit self clears to 0.
5:4	OCFAULT[1:0]	These bits enable/disable open-circuit fault detection and select fault detection timing. See Open-Circuit Fault Detection section and Table 4 for operation of these bits.
3	CJ	Cold-Junction Sensor Disable 0 = Cold-junction temperature sensor enabled (default) 1 = Cold-junction temperature sensor disabled. Data from an external temperature sensor may be written to the cold-junction temperature register. When this bit changes from 0 to 1, the most recent cold-junction temperature value will remain in the cold-junction temperature register until the internal sensor is enabled or until a new value is written to the register. The overall temperature conversion time is reduced by 25ms (typ) when this bit is set to 1.
2	FAULT	Fault Mode 0 = Comparator Mode. The \overline{FAULT} output and respective fault bit reflects the state of any non-masked faults by asserting when the fault condition is true, and deasserting when the fault condition is no longer true. There is a 2°C hysteresis when in comparator mode for threshold fault conditions. (default) 1 = Interrupt Mode. The \overline{FAULT} output and respective fault bit asserts when a non-masked fault condition is true and remain asserted until a 1 is written to the Fault Status Clear bit. This deasserts \overline{FAULT} and respective fault bit until a new fault is detected (note that this may occur immediately if the fault condition is still in place).
1	FAULTCLR	Fault Status Clear 0 = Default 1 = When in interrupt mode, returns all Fault Status bits [7:0] in the Fault Status Register (0Fh) to 0 and deasserts the \overline{FAULT} output. This bit has no effect in comparator mode. Note that the \overline{FAULT} output and the fault bit may reassert immediately if the fault persists. To prevent the \overline{FAULT} output from reasserting, first set the Fault Mask bits. The fault status clear bit self-clears to 0.
0	50/60Hz	50Hz/60Hz Noise Rejection Filter Selection 0= Selects rejection of 60Hz and its harmonics (default) 1= Selects rejection of 50Hz and its harmonics Note: Change the notch frequency only while in the “Normally Off” mode – not in the Automatic Conversion mode.

Register 01h/81h: Configuration 1 Register (CR1)

The Configuration 1 register selects the averaging time for the thermocouple voltage conversion averaging mode and also selects the thermocouple type being monitored.

Default Value: 03h

MEMORY ACCESS	N/A	R/W	R/W	R/W	R/W	R/W	R/W	R/W
01h/81h	Reserved	AVGSEL ₂	AVGSEL ₁	AVGSEL ₀	TC TYPE ₃	TC TYPE ₂	TC TYPE ₁	TC TYPE ₀
	Bit 7			Bit 0				

BIT	NAME	DESCRIPTION
7	Reserved	Reserved.
6:4	AVGSEL[2:0]	<p>Thermocouple Voltage Conversion Averaging Mode</p> <p>000 = 1 sample (default) 001 = 2 samples averaged 010 = 4 samples averaged 011 = 8 samples averaged 1xx = 16 samples averaged</p> <p>Adding samples increases the conversion time and reduces noise.</p> <p>Typical conversion times:</p> <p>1-shot or first conversion in Auto mode: = $t_{CONV} + (\text{samples} - 1) \times 33.33\text{mS}$ (60Hz rejection) = $t_{CONV} + (\text{samples} - 1) \times 40\text{mS}$ (50Hz rejection)</p> <p>2 thru n conversions in Auto mode = $t_{CONV} + (\text{samples} - 1) \times 16.67\text{mS}$ (60Hz rejection) = $t_{CONV} + (\text{samples} - 1) \times 20\text{mS}$ (50Hz rejection)</p> <p>The Thermocouple Voltage Conversion Averaging Mode settings should not be changed while conversions are taking place.</p>
3:0	TC TYPE[3:0]	<p>Thermocouple Type</p> <p>0000 = B Type 0001 = E Type 0010 = J Type 0011 = K Type (default) 0100 = N Type 0101 = R Type 0110 = S Type 0111 = T Type</p> <p>10xx = Voltage Mode, Gain = 8. Code = $8 \times 1.6 \times 2^{17} \times V_{IN}$ 11xx = Voltage Mode, Gain = 32. Code = $32 \times 1.6 \times 2^{17} \times V_{IN}$</p> <p>Where Code is 19 bit signed number from TC registers and V_{IN} is thermocouple input voltage</p>

Register 02h/82h: Fault Mask Register (MASK)

The Fault Mask Register allows the user to mask faults from causing the $\overline{\text{FAULT}}$ output from asserting. Masked faults will still result in fault bits being set in the Fault Status register (0Fh). Note that the $\overline{\text{FAULT}}$ output is never asserted by thermocouple and cold-junction out-of-range status.

Default Value: FFh

MEMORY ACCESS	N/A	N/A	R/W	R/W	R/W	R/W	R/W	R/W	
02h/82h	Reserved	Reserved	CJ High FAULT Mask	CJ Low FAULT Mask	TC High FAULT Mask	TC Low FAULT Mask	OV/UV FAULT Mask	Open FAULT Mask	
	Bit 7							Bit 0	

BIT	NAME	DESCRIPTION
7:6	Reserved	Reserved.
5	CJ High FAULT Mask	Cold-Junction High Fault Threshold Mask 0 = $\overline{\text{FAULT}}$ output asserted when the Cold-Junction Temperature rises above the Cold-Junction Temperature high threshold limit value 1 = $\overline{\text{FAULT}}$ output masked (default)
4	CJ Low FAULT Mask	Cold-Junction Low Fault Threshold Mask 0 = $\overline{\text{FAULT}}$ output asserted when the Cold-Junction Temperature falls below the Cold-Junction Temperature low threshold limit value 1 = $\overline{\text{FAULT}}$ output masked (default)
3	TC High FAULT Mask	Thermocouple Temperature High Fault Threshold Mask 0 = $\overline{\text{FAULT}}$ output asserted when the Thermocouple Temperature rises above the Thermocouple Temperature high threshold limit value 1 = $\overline{\text{FAULT}}$ output masked (default)
2	TC Low FAULT Mask	Thermocouple Temperature Low Fault Threshold Mask 0 = $\overline{\text{FAULT}}$ output asserted when the Thermocouple Temperature falls below the Thermocouple Temperature low threshold limit value 1 = $\overline{\text{FAULT}}$ output masked (default)
1	OV/UV FAULT Mask	Over-voltage or Undervoltage Input Fault Mask 0 = $\overline{\text{FAULT}}$ output asserted when an over- or undervoltage condition is detected 1 = $\overline{\text{FAULT}}$ output masked (default)
0	Open FAULT Mask	Thermocouple Open-Circuit Fault Mask 0 = $\overline{\text{FAULT}}$ output asserted when a thermocouple open condition is detected 1 = $\overline{\text{FAULT}}$ output masked (default)

Register 03h/83h: Cold-Junction High Fault Threshold Register (CJHF)

Write a temperature limit value to this register. When the measured cold-junction temperature is greater than this value, the CJ High fault status bit will be set and (if not masked) the $\overline{\text{FAULT}}$ output will assert.

Default Value: 7Fh

MEMORY ACCESS	R/W	R/W	R/W	R/W	R/W	R/W	R/W	R/W
03h/83h	CJHF7	CJHF6	CJHF5	CJHF4	CJHF3	CJHF2	CJHF1	CJHF0
	Sign	2 ⁶	2 ⁵	2 ⁴	2 ³	2 ²	2 ¹	2 ⁰
	Bit 7							Bit 0

Register 04h/84h: Cold-Junction Low Fault Threshold Register (CJLF)

Write a temperature limit value to this register. When the measured cold-junction temperature is less than this value, the CJ Low fault status bit will be set and (if not masked) the $\overline{\text{FAULT}}$ output will assert.

Default Value: C0h

MEMORY ACCESS	R/W	R/W	R/W	R/W	R/W	R/W	R/W	R/W
04h/84h	CJLF7	CJLF6	CJLF5	CJLF4	CJLF3	CJLF2	CJLF1	CJLF0
	Sign	2 ⁶	2 ⁵	2 ⁴	2 ³	2 ²	2 ¹	2 ⁰
	Bit 7							Bit 0

Register 05h/85h: Linearized Temperature High Fault Threshold Register, MSB (LTHFTH)

Write the MSB of the two-byte temperature limit value to this register. When the linearized thermocouple temperature is greater than the two-byte (05h and 06h) limit value, the TC High fault status bit will be set and (if not masked) the $\overline{\text{FAULT}}$ output will assert.

Default Value: 7Fh

MEMORY ACCESS	R/W	R/W	R/W	R/W	R/W	R/W	R/W	R/W
05h/85h	LTHFTH7	LTHFTH6	LTHFTH5	LTHFTH4	LTHFTH3	LTHFTH2	LTHFTH1	LTHFTH0
	Sign	2 ¹⁰	2 ⁹	2 ⁸	2 ⁷	2 ⁶	2 ⁵	2 ⁴
	Bit 7							Bit 0

Register 06h/86h: Linearized Temperature High Fault Threshold Register, LSB (LTHFTL)

Write the LSB of the two-byte temperature limit value to this register. When the linearized thermocouple temperature is greater than the two-byte (05h and 06h) limit value, the TC High fault status bit will be set and (if not masked) the $\overline{\text{FAULT}}$ output will assert.

Default Value: FFh

MEMORY ACCESS	R/W	R/W	R/W	R/W	R/W	R/W	R/W	R/W
06h/86h	LTHFTL7	LTHFTL6	LTHFTL5	LTHFTL4	LTHFTL3	LTHFTL2	LTHFTL1	LTHFTL0
	2 ³	2 ²	2 ¹	2 ⁰	2 ⁻¹	2 ⁻²	2 ⁻³	2 ⁻⁴
	Bit 7							Bit 0

Register 07h/87h: Linearized Temperature Low Fault Threshold Register, MSB (LTLFTH)

Write the MSB of the two-byte temperature limit value to this register. When the linearized thermocouple temperature is less than the two-byte (07h and 08h) limit value, the TC Low fault status bit will be set and (if not masked) the $\overline{\text{FAULT}}$ output will assert.

Default Value: 80h

MEMORY ACCESS	R/W	R/W	R/W	R/W	R/W	R/W	R/W	R/W
07h/87h	LTLFTH7	LTLFTH6	LTLFTH5	LTLFTH4	LTLFTH3	LTLFTH2	LTLFTH1	LTLFTH0
	Sign	2^{10}	2^9	2^8	2^7	2^6	2^5	2^4
	Bit 7							Bit 0

Register 08h/88h: Linearized Temperature Low Fault Threshold Register, LSB (LTLFTL)

Write the LSB of the two-byte temperature limit value to this register. When the linearized thermocouple temperature is less than the two-byte (07h and 08h) limit value, the TC Low fault status bit will be set and (if not masked) the $\overline{\text{FAULT}}$ output will assert.

Default Value: 00h

MEMORY ACCESS	R/W	R/W	R/W	R/W	R/W	R/W	R/W	R/W
08h/88h	LTLFTL7	LTLFTL6	LTLFTL5	LTLFTL4	LTLFTL3	LTLFTL2	LTLFTL1	LTLFTL0
	2^3	2^2	2^1	2^0	2^{-1}	2^{-2}	2^{-3}	2^{-4}
	Bit 7							Bit 0

Register 09h/89h: Cold-Junction Temperature Offset Register (CJTO)

When the cold-junction temperature sensor is enabled, this register allows an offset temperature to be applied to the measured value. See the [Cold-Junction Temperature Sensing](#) section of this data sheet for additional information.

Default Value: 00h

MEMORY ACCESS	R/W	R/W	R/W	R/W	R/W	R/W	R/W	R/W
09h/89h	CJTO7	CJTO6	CJTO5	CJTO4	CJTO3	CJTO2	CJTO1	CJTO0
	Sign	2^2	2^1	2^0	2^{-1}	2^{-2}	2^{-3}	2^{-4}
	Bit 7							Bit 0

Register 0Ah/8Ah: Cold-Junction Temperature Register, MSB (CJTH)

This register contains the MSB of the two-byte (0Ah and 0Bh) value used for cold-junction compensation of the thermocouple measurement. When the cold-junction temperature sensor is enabled, this register is read-only and contains the MSB of the measured cold-junction temperature plus the value in the Cold-Junction Offset register. Also when the cold-junction temperature sensor is enabled, a read of this register will reset the $\overline{\text{DRDY}}$ pin high. When the cold-junction temperature sensor is disabled, this register becomes a read-write register that contains the MSB of the most recent cold-junction conversion result until a new value is written into it. This allows writing the results from an external temperature sensor, if desired. The maximum contained in the two cold-junction temperature bytes is clamped at 128°C and the minimum is clamped at -64°C.

Default Value: 00h

MEMORY ACCESS	R/W	R/W	R/W	R/W	R/W	R/W	R/W	R/W
0Ah/8Ah	CJTH7	CJTH6	CJTH5	CJTH4	CJTH3	CJTH2	CJTH1	CJTH0
	Sign	2 ⁶	2 ⁵	2 ⁴	2 ³	2 ²	2 ¹	2 ⁰
	Bit 7							Bit 0

Register 0Bh/8Bh: Cold-Junction Temperature Register, LSB (CJTL)

This register contains LSB of the two-byte (0Ah and 0Bh) value used for cold-junction compensation of the thermocouple measurement. When the cold-junction temperature sensor is enabled, this register is read-only and contains the LSB of the measured cold-junction temperature plus the value in the Cold-Junction Offset register. Also when the cold-junction temperature sensor is enabled, a read of this register will reset the $\overline{\text{DRDY}}$ pin high. When the cold-junction temperature sensor is disabled, this register becomes a read-write register that contains the LSB of the most recent cold-junction conversion result until a new value is written into it.

Default Value: 00h

MEMORY ACCESS	R/W	R/W	R/W	R/W	R/W	R/W	R	R	
0Bh/8Bh	CJTL7	CJTL6	CJTL5	CJTL4	CJTL3	CJTL2	CJTL1	CJTL0	
	2 ⁻¹	2 ⁻²	2 ⁻³	2 ⁻⁴	2 ⁻⁵	2 ⁻⁶	0	0	
	Bit 7							Bit 0	

Register 0Ch: Linearized TC Temperature, Byte 2 (LTCBH)

This is the high byte of the 19-bit register that contains the linearized and cold-junction-compensated thermocouple temperature value.

Default Value: 00h

MEMORY ACCESS	R	R	R	R	R	R	R	R	
0Ch	LTCBH7	LTCBH6	LTCBH5	LTCBH4	LTCBH3	LTCBH2	LTCBH1	LTCBH0	
	Sign	2 ¹⁰	2 ⁹	2 ⁸	2 ⁷	2 ⁶	2 ⁵	2 ⁴	
	Bit 7							Bit 0	

Register 0Dh: Linearized TC Temperature, Byte 1 (LTCBM)

This is the middle byte of the 19-bit register that contains the linearized and cold-junction-compensated thermocouple temperature value.

Default Value: 00h

MEMORY ACCESS	R	R	R	R	R	R	R	R
0Dh	LTCBM7	LTCBM6	LTCBM5	LTCBM4	LTCBM3	LTCBM2	LTCBM1	LTCBM0
	2 ³	2 ²	2 ¹	2 ⁰	2 ⁻¹	2 ⁻²	2 ⁻³	2 ⁻⁴
	Bit 7				Bit 0			

Register 0Eh: Linearized TC Temperature, Byte 0 (LTCBL)

This is the low byte of the 19-bit register that contains the linearized and cold-junction-compensated thermocouple temperature value.

Default Value: 00h

MEMORY ACCESS	R	R	R	R	R	R	R	R
0Eh	LTCBL7	LTCBL6	LTCBL5	LTCBL4	LTCBL3	LTCBL2	LTCBL1	LTCBL0
	2 ⁻⁵	2 ⁻⁶	2 ⁻⁷	X	X	X	X	X
	Bit 7				Bit 0			

Register 0Fh: Fault Status Register (SR)

The Fault Status Register contains eight bits that indicate the fault conditions (Thermocouple Out-of-Range, Cold Junction Out-of-Range, Cold Junction High, Cold Junction Low, Thermocouple High Temperature, Thermocouple Low Temperature, Over-Under Voltage, or Open Thermocouple) that have been detected.

Default Value: 00h

MEMORY ACCESS	R	R	R	R	R	R	R	R
0Fh	CJ Range	TC Range	CJHIGH	CJLOW	TCHIGH	TCLOW	OVUV	OPEN
	Bit 7				Bit 0			

Note: When the MAX31856 is set to operate in “comparator” fault mode (set with bit 2 of Configuration 0 register (00h)), the fault status bits simply reflect the state of any faults by asserting when the fault condition is true, and deasserting when the fault condition is no longer true.

When in “interrupt” fault mode, the fault status bits assert when a fault condition is true. The bits remain asserted until a 1 is written to the Fault Status Clear bit. This deasserts the fault bits until a new fault is detected (note that this may occur immediately if the fault condition is still in place).

Register 0Fh: Fault Status Register (SR) (continued)

BIT	NAME	DESCRIPTION
7	CJ Range	Cold Junction Out-of-Range 0 = The Cold-Junction temperature is within the normal operating range (-55°C to +125°C for types E, J, K, N, and T; -50°C to +125°C for types R and S; 0 to 125°C for type B). 1 = The Cold-Junction temperature is outside of the normal operating range.
6	TC Range	Thermocouple Out-of-Range 0 = The Thermocouple Hot Junction temperature is within the normal operating range (see Table 1). 1 = The Thermocouple Hot Junction temperature is outside of the normal operating range. Note: The TC Range bit should be ignored in voltage mode.
5	CJHIGH	Cold-Junction High Fault 0 = The Cold-Junction temperature is at or lower than the cold-junction temperature high threshold (default). 1 = The Cold-Junction temperature is higher than the cold-junction temperature high threshold. The $\overline{\text{FAULT}}$ output is asserted unless masked.
4	CJLOW	Cold-Junction Low Fault 0 = The Cold-Junction temperature is at or higher than the cold-junction temperature low threshold (default). 1 = The Cold-Junction temperature is lower than the cold-junction temperature low threshold. The $\overline{\text{FAULT}}$ output is asserted unless masked.
3	TCHIGH	Thermocouple Temperature High Fault 0 = The Thermocouple Temperature is at or lower than the thermocouple temperature high threshold (default). 1 = The Thermocouple Temperature is higher than the thermocouple temperature high threshold. The $\overline{\text{FAULT}}$ output is asserted unless masked.
2	TCLow	Thermocouple Temperature Low Fault 0 = Thermocouple temperature is at or higher than the thermocouple temperature low threshold (default). 1 = Thermocouple temperature is lower than the thermocouple temperature low threshold. The $\overline{\text{FAULT}}$ output is asserted unless masked.
1	OVUV	Overvoltage or Undervoltage Input Fault 0 = The input voltage is positive and less than V_{DD} (default). 1 = The input voltage is negative or greater than V_{DD} . The $\overline{\text{FAULT}}$ output is asserted unless masked. Note: The presence of the OVUV fault will suspend conversions and the ability of the MAX31856 to detect other faults (or clear faults when in comparator mode) until the fault is no longer present.
0	OPEN	Thermocouple Open-Circuit Fault 0 = No open circuit or broken thermocouple wires are detected (default) 1 = An open circuit such as broken thermocouple wires has been detected. The $\overline{\text{FAULT}}$ output is asserted unless masked.

Applications Information

Thermocouple Temperature Sensing Guidelines

Follow these guidelines to get the best results when sensing temperature. The [Typical Application Circuit](#) shows a basic MAX31856 schematic. Connect the thermocouple wires to inputs T+ and T-; be sure that the wires are connected to the correct input as shown in [Figure 8](#). Connect the BIAS output to T-. This biases the thermocouple within the common-mode range of the inputs.

Noise Considerations

Because of the small signal levels involved, thermocouple temperature measurement is susceptible to power-supply-coupled noise. The effects of power-supply noise can be minimized by placing 0.1 μF ceramic bypass capacitors close to the V_{DD} pins and to GND.

The input amplifier is a low-noise amplifier designed to enable high-precision input sensing. Keep the thermocouple and connecting wires away from electrical noise sources. It is strongly recommended to add a 100nF ceramic surface-mount differential capacitor, placed across the T+ and T- pins, to filter noise on the thermocouple lines. In environments with high noise levels, especially significant RF fields, a 100nF capacitor between T+ and T- should be supplemented with a 10nF capacitor between T+ and GND, and another 10nF capacitor between T- and GND.

These values may need to be modified depending on the nature of the noise pickup. Other techniques, such as adding series resistance and shielding the thermocouple wires and circuit board, may also be necessary in the presence of larger noise sources. [Figure 8](#) shows the typical application circuit with input capacitors and input resistors added.

Input Protection

The $\pm 45\text{V}$ input protection circuitry prevents damage to the IC caused by overvoltage conditions at T+, T-, or BIAS. If larger input faults are possible, external protection should be added. Resistors in series with T+, T-, and BIAS can increase the acceptable fault voltages. For example, adding 2k Ω in series with these inputs allows an additional $\pm 40\text{V}$ of overdrive before the 20mA input current limit is reached. Note, however, that if the input has 45V across it and 20mA flowing into it, the power dissipation will be 900mW due to the overdrive at that input. Overdriving other inputs at the same time will further increase the power dissipation. Always ensure that if a continuous overdrive voltage greater than $\pm 45\text{V}$ is expected, any current-limiting resistors are large enough to keep total power dissipation well under the IC's absolute maximum power dissipation. Note also that added resistance in series with T+ and T- can increase offset voltage, as mentioned in the [Effect of Series Resistance](#) section.

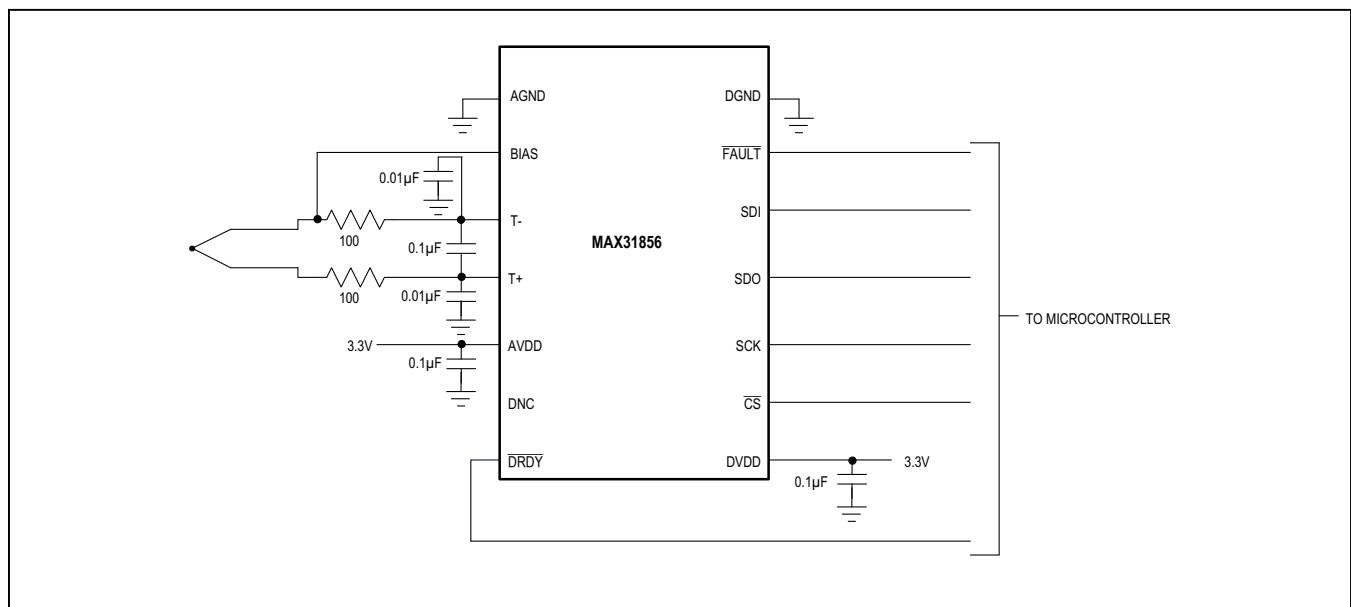

Figure 8. Typical Connection to Reduce the Effect of Noise Pickup in the Thermocouple Cable

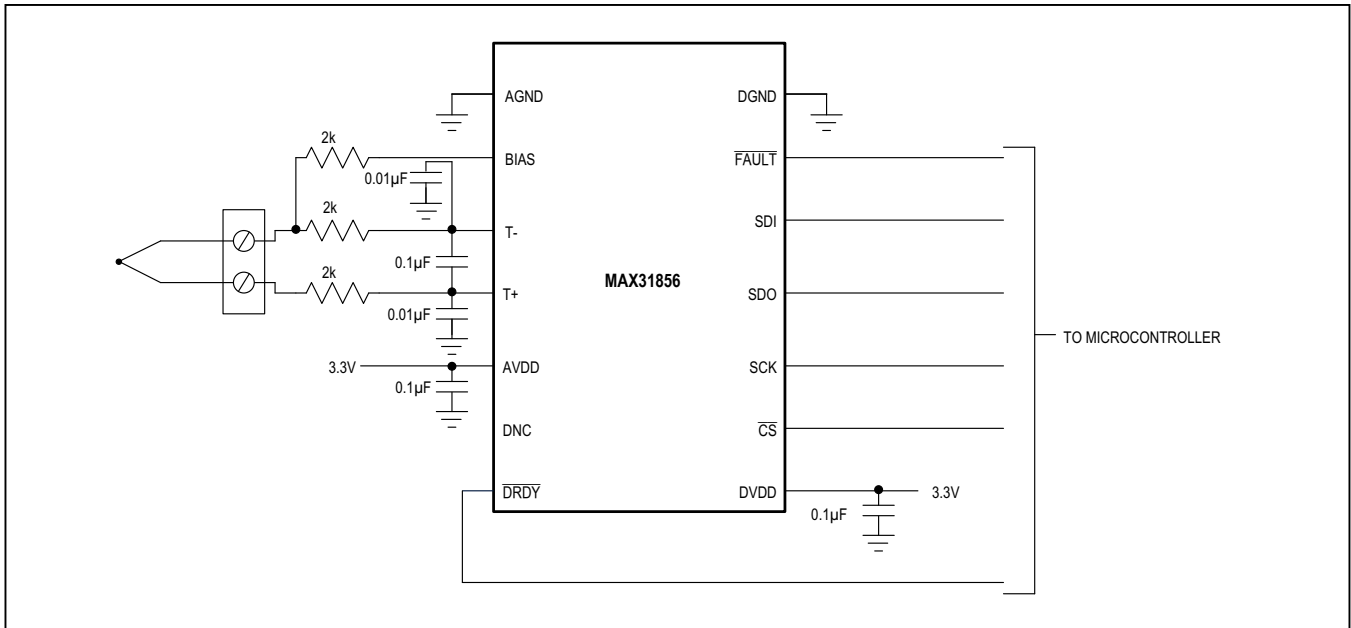

Figure 9. When Thermocouple Inputs May Be Exposed to Fault Voltages Greater than ±45V, Resistors Can Be Added to Limit Current into the MAX31856.

Effect of Series Resistance

Bias and leakage current at the thermocouple inputs will flow through input resistors and cable resistance, generating input offset voltage. For the circuits in Figure 8 and Figure 9, assuming that the thermocouple’s source resistance is negligible, the offset voltage due to series resistance will be:

$$I_B \times \Delta R_S + \Delta I_B \times R_S$$

where:

- R_S is the series resistance between each input and the bias point
- ΔR_S is the difference between the two R_S values. This will generally be equal to the tolerance of any discrete series resistors plus any cable resistance.
- I_B is the input bias and leakage current
- ΔI_B is the differential input bias and leakage current

As an example, assume that the circuit in Figure 8 will be used up to a temperature of 85°C, the mismatch between the 100Ω input resistors is 1Ω, and the external cable resistance is 50Ω. This yields a worst-case offset voltage due to the external resistances of:

$$65nA \times (50\Omega + 1\Omega) + 4nA \times 100\Omega = 3.7\mu V$$

To minimize the effect of input resistance on accuracy:

- Minimize the values of any external resistors
- When the cable resistance is very low, match the values of the external resistors as closely as possible.
- If the cable resistance is known, increase the value of the resistor connected to T- by the value of the cable resistance. This will minimize the total mismatch between the two inputs.

If the cable resistance is excessive, consider using larger-gauge thermocouple wire.

MAX31856 Location

Because the MAX31856 includes an internal cold-junction temperature sensor, place it in a location whose temperature is as close as possible to that of the cold junction. If the thermocouple leads are directly soldered to the PCB, the MAX31856 should be as close as possible to the thermocouple lead connections and thermal gradients between the IC and the thermocouple connections should be minimized. If the thermocouple leads terminate in a connector, mount the IC as close as possible to the connector, and again minimize thermal gradients between the connector and the IC.

Using “Unsupported” Thermocouple Types

To use a thermocouple type other than B, E, J, K, N, R, S, or T, select one of the voltage mode options in Configuration 1. Selecting “Gain = 8” results in a full-scale input voltage range of ±78.125mV. “Gain = 32” results in a full-scale input voltage range of ±19.531mV. See

the transfer functions from the Configuration 1 Register table. When voltage mode is selected, no linearization is performed on the conversion data. Use the voltage data and the cold-junction temperature to calculate the thermocouple’s hot-junction temperature.

Ordering Information

PART	TEMP RANGE	PIN-PACKAGE
MAX31856MUD+	-55°C to +125°C	14 TSSOP
MAX31856MUD+T	-55°C to +125°C	14 TSSOP

+Denotes a lead(Pb)-free/RoHS-compliant package.
T = Tape and reel.

Package Information

For the latest package outline information and land patterns (footprints), go to www.maximintegrated.com/packages. Note that a “+”, “#”, or “-” in the package code indicates RoHS status only. Package drawings may show a different suffix character, but the drawing pertains to the package regardless of RoHS status.

PACKAGE TYPE	PACKAGE CODE	OUTLINE NO.	LAND PATTERN NO.
14 TSSOP	U14+2	21-0066	90-0113

Revision History

REVISION NUMBER	REVISION DATE	DESCRIPTION	PAGES CHANGED
0	2/15	Initial release	—

For pricing, delivery, and ordering information, please contact Maxim Direct at 1-888-629-4642, or visit Maxim Integrated's website at www.maximintegrated.com.

Maxim Integrated cannot assume responsibility for use of any circuitry other than circuitry entirely embodied in a Maxim Integrated product. No circuit patent licenses are implied. Maxim Integrated reserves the right to change the circuitry and specifications without notice at any time. The parametric values (min and max limits) shown in the Electrical Characteristics table are guaranteed. Other parametric values quoted in this data sheet are provided for guidance.