

## RS-485 Transceivers with Low-Voltage Logic Interface

### General Description

The MAX13430E–MAX13433E are full- and half-duplex RS-485 transceivers that feature an adjustable low-voltage logic interface for operation in multivoltage systems. This allows direct interfacing to low-voltage ASIC/FPGAs without extra components. The MAX13430E–MAX13433E RS-485 transceivers operate with a V<sub>CC</sub> voltage supply from +3V to +5V. The low-voltage logic interface operates with a voltage supply from +1.62V to V<sub>CC</sub>.

The MAX13430E/MAX13432E feature reduced slew-rate drivers that minimize EMI and reduce reflections caused by improperly terminated cables, allowing error-free data transmission up to 500kbps. The MAX13431E/MAX13433E driver slew rates are not limited, enabling data transmission up to 16Mbps. The MAX13430E/MAX13431E are intended for half-duplex communications, and the MAX13432E/MAX13433E are intended for full-duplex communications.

The MAX13430E/MAX13431E are available in 10-pin μMAX® and 10-pin TDFN packages. The MAX13432E/MAX13433E are available in 14-pin TDFN and 14-pin SO packages.

### Applications

Industrial Control Systems	Motor Control
Portable Industrial Equipment	HVAC

### Features

- ◆ Wide +3V to +5V Input Supply Range
- ◆ Low-Voltage Logic Interface +1.62V (min)
- ◆ Ultra-Low Supply Current in Shutdown Mode  
10μA I<sub>CC</sub> (max), 1μA I<sub>L</sub> (max)
- ◆ Thermal Shutdown Protection
- ◆ Hot-Swap Input Structures on DE and  $\overline{RE}$
- ◆ 1/8-Unit Load Allows Up to 256 Transceivers on the Bus
- ◆ Enhanced Slew-Rate Limiting (MAX13430E/MAX13432E)
- ◆ Extended ESD Protection for RS-485 I/O Pins  
±30kV Human Body Model  
±15kV Air-Gap Discharge per IEC 61000-4-2  
±10kV Contact Discharge per IEC 61000-4-2
- ◆ Extended -40°C to +85°C Operating Temperature Range
- ◆ Space-Saving TDFN and μMAX Packages

*Typical Application Circuits appears at end of data sheet.*

### Ordering Information/Selector Guide

PART	PIN-PACKAGE	FULL/HALF DUPLEX	DATA RATE (Mbps)	SLEW RATE LIMITED	TRANSCEIVERS ON BUS	TOP MARK	PACKAGE CODE
MAX13430EETB+	10 TDFN-EP* (3mm x 3mm)	Half	0.5	Yes	256	AUS	T1033-1
MAX13430EEUB+	10 μMAX (3mm x 3mm)	Half	0.5	Yes	256	—	U10-2
MAX13431EETB+	10 TDFN-EP* (3mm x 3mm)	Half	16	No	256	AUT	T1033-1
MAX13431EEUB+	10 μMAX (3mm x 3mm)	Half	16	No	256	—	U10-2
MAX13432EESD+	14 SO	Full	0.5	Yes	256	—	S14-1
MAX13432EETD+	14 TDFN-EP* (3mm x 3mm)	Full	0.5	Yes	256	AEG	T1433-2
MAX13433EESD+	14 SO	Full	16	No	256	—	S14-1
MAX13433EESD/V+	14 SO	Full	16	No	256	—	S14-1
MAX13433EETD+	14 TDFN-EP* (3mm x 3mm)	Full	16	No	256	AEH	T1433-2

**Note:** All devices are specified over the extended -40°C to +85°C operating temperature range.

+Denotes a lead(Pb)-free/RoHS-compliant package.

\*EP = Exposed pad.

/V denotes an automotive qualified part.

μMAX is a registered trademark of Maxim Integrated Products, Inc.

**For pricing, delivery, and ordering information, please contact Maxim Direct at 1-888-629-4642, or visit Maxim's website at [www.maximintegrated.com](http://www.maximintegrated.com).**

# MAX13430E–MAX13433E

## RS-485 Transceivers with Low-Voltage Logic Interface

### ABSOLUTE MAXIMUM RATINGS

(All voltages referenced to GND.)

Supply Voltage ( $V_{CC}$ )	-0.3V to +6V	14-Pin TDFN (derate 24.4mW/°C above +70°C)	1951mW
Logic Supply Voltage ( $V_L$ )	-0.3V to +6V	14-Pin SO (derate 11.9mW/°C above +70°C)	952mW
Control Input Voltage ( $\overline{RE}$ )	-0.3V to +6V	Junction-to-Ambient Thermal Resistance ( $\theta_{JA}$ ) (Note 1)	
Control Input Voltage (DE)	-0.3V to +6V	10-Pin $\mu$ MAX	113.1°C/W
Driver Input Voltage (DI)	-0.3V to +6V	10-Pin TDFN	41°C/W
Driver Output Voltage (Y, Z, A, B)	-8V to +13V	14-Pin TDFN	41°C/W
Receiver Input Voltage (A, B)		14-Pin SO	84°C/W
(MAX13430E/MAX13431E)	-8V to +13V	Junction-to-Ambient Thermal Resistance ( $\theta_{JC}$ ) (Note 1)	
Receiver Input Voltage (A, B)		10-Pin $\mu$ MAX	42°C/W
(MAX13432E/MAX13433E)	-25V to +25V	10-Pin TDFN	9°C/W
Receiver Output Voltage (RO)	-0.3V to ( $V_L + 0.3V$ )	14-Pin TDFN	8°C/W
Driver Output Current	$\pm 250$ mA	14-Pin SO	34°C/W
Short-Circuit Duration (RO, A, B) to GND	Continuous	Operating Temperature Range	-40°C to +85°C
Power Dissipation ( $T_A = +70^\circ\text{C}$ )		Junction Temperature	+150°C
10-Pin $\mu$ MAX (derate 8.8mW/°C above +70°C)	707mW	Storage Temperature Range	-65°C to +150°C
10-Pin TDFN (derate 24.4mW/°C above +70°C)	1951mW	Lead Temperature (soldering, 10s)	+300°C
		Soldering Temperature (reflow)	+260°C

**Note 1:** Package thermal resistances were obtained using the method described in JEDEC specification JESD51-7, using a four-layer board. For detailed information on package thermal considerations, refer to [www.maxim-ic.com/thermal-tutorial](http://www.maxim-ic.com/thermal-tutorial).

Stresses beyond those listed under “Absolute Maximum Ratings” may cause permanent damage to the device. These are stress ratings only, and functional operation of the device at these or any other conditions beyond those indicated in the operational sections of the specifications is not implied. Exposure to absolute maximum rating conditions for extended periods may affect device reliability.

### DC ELECTRICAL CHARACTERISTICS

( $V_{CC} = +3V$  to +5.5V,  $V_L = +1.8V$  to  $V_{CC}$ ,  $T_A = -40^\circ\text{C}$  to +85°C, unless otherwise noted. Typical values are  $V_{CC} = +5V$ ,  $V_L = +1.8V$  at  $T_A = +25^\circ\text{C}$ .) (Notes 2, 3)

PARAMETER	SYMBOL	CONDITIONS	MIN	TYP	MAX	UNITS
<b>POWER SUPPLY</b>						
$V_{CC}$ Supply-Voltage Range	$V_{CC}$		3		5.5	V
$V_L$ Supply-Voltage Range	$V_L$		1.62		$V_{CC}$	V
$I_{CC}$ Supply Current	$I_{CC}$	DE = $\overline{RE}$ = high, no load DE = $\overline{RE}$ = low, no load DE = high, $\overline{RE}$ = low, no load			2	mA
$I_{CC}$ Supply Current in Shutdown Mode	$I_{SHDN}$	DE = low, $\overline{RE}$ = high, no load			10	$\mu$ A
$V_L$ Supply Current	$I_L$	RO = no load			1	$\mu$ A
<b>DRIVER</b>						
Differential Driver Output (Figure 1)	$V_{OD}$	$R_L = 100\Omega$ , $V_{CC} = +3V$	2		$V_{CC}$	V
		$R_L = 54\Omega$ , $V_{CC} = +3V$	1.5		$V_{CC}$	
		$R_L = 100\Omega$ , $V_{CC} = +4.5V$	2.25		$V_{CC}$	
		$R_L = 54\Omega$ , $V_{CC} = +4.5V$	2.25		$V_{CC}$	
Change in Magnitude of Differential Output Voltage	$\Delta V_{OD}$	$R_L = 100\Omega$ or $54\Omega$ , Figure 1 (Note 4)			0.2	V
Driver Common-Mode Output Voltage	$V_{OC}$	$R_L = 100\Omega$ or $54\Omega$ , Figure 1		$V_{CC}/2$	3	V
Change in Magnitude of Common-Mode Voltage	$\Delta V_{OC}$	$R_L = 100\Omega$ or $54\Omega$ , Figure 1 (Note 4)			0.2	V

# MAX13430E-MAX13433E

## RS-485 Transceivers with Low-Voltage Logic Interface

### DC ELECTRICAL CHARACTERISTICS (continued)

( $V_{CC} = +3V$  to  $+5.5V$ ,  $V_L = +1.8V$  to  $V_{CC}$ ,  $T_A = -40^{\circ}C$  to  $+85^{\circ}C$ , unless otherwise noted. Typical values are  $V_{CC} = +5V$ ,  $V_L = +1.8V$  at  $T_A = +25^{\circ}C$ .) (Notes 2, 3)

PARAMETER	SYMBOL	CONDITIONS	MIN	TYP	MAX	UNITS
Output Leakage Current (Y and Z)	$I_{OLK}$	DE = GND, $V_{CC} = V_{GND}$ or $+5.5V$	$V_{IN} = +12V$		125	$\mu A$
			$V_{IN} = -7V$	-100		
Driver Short-Circuit Output Current (Note 5)	$I_{OSD}$	$0 \leq V_{OUT} \leq +12V$			+250	mA
		$-7V \leq V_{OUT} \leq V_{CC}$	-250			
Driver Short-Circuit Output Foldback Current (Note 5)	$I_{OSDF}$	$(V_{CC} - 1V) \leq V_{OUT} \leq +12V$	15			mA
		$-7V \leq V_{OUT} \leq +1V$			-15	
Thermal Shutdown Threshold	$T_{TS}$			+150		$^{\circ}C$
Thermal Shutdown Hysteresis	$T_{TSH}$			15		$^{\circ}C$
<b>RECEIVER</b>						
Input Current (A and B)	$I_{A, B}$	DE = GND, $V_{CC} = V_{GND}$ or $+5.5V$	$V_{CM} = +12V$		125	$\mu A$
			$V_{CM} = -7V$	-100		
Receiver Differential Threshold Voltage	$V_{TH}$	$-7V \leq V_{CM} \leq +12V$	-200		-50	mV
Receiver Input Hysteresis	$\Delta V_{TH}$	$V_{CM} = 0$		15		mV
Receiver Input Resistance	$R_{IN}$	$-7V \leq V_{CM} \leq +12V$	96			$k\Omega$
<b>LOGIC INTERFACE</b>						
Input High Logic Level (DI, DE, $\overline{RE}$ )	$V_{IH}$		$2/3 \times V_L$			V
Input Low Logic Level (DI, DE, $\overline{RE}$ )	$V_{IL}$			$1/3 \times V_L$		V
Input Current (DI, DE, $\overline{RE}$ )	$I_{IN}$	$V_{DI} = V_{DE} = V_{\overline{RE}} = V_L = +5.5V$			$\pm 1$	$\mu A$
Input Impedance on First Transition	$R_{DE, \overline{RE}}$		1		10	$k\Omega$
Output High Logic Level (RO)	$V_{OH}$	$I_O = -1mA, V_A - V_B = V_{TH}$	$V_L - 0.4$			V
Output Low Logic Level (RO)	$V_{OL}$	$I_O = 1mA, V_A - V_B = -V_{TH}$			0.4	V
Receiver Three-State Output Current (RO)	$I_{OZR}$	$0 \leq V_{RO} \leq V_L$	-1	0.01	+1	$\mu A$
Receiver Output Short-Circuit Current (RO)	$I_{OSR}$	$0 \leq V_{RO} \leq V_L$	-110		+110	mA
<b>ESD PROTECTION</b>						
A, B, Y, Z to GND		IEC 61000-4-2 Air Gap Discharge		$\pm 15$		kV
		IEC 61000-4-2 Contact Discharge		$\pm 10$		
		Human Body Model		$\pm 30$		
All Other Pins (Except A, B, Y, and Z)		Human Body Model		$\pm 2$		kV

# MAX13430E-MAX13433E

## RS-485 Transceivers with Low-Voltage Logic Interface

### SWITCHING CHARACTERISTICS (MAX13431E/MAX13433E (16Mbps))

( $V_{CC} = +3V$  to  $+5.5V$ ,  $V_L = +1.8V$  to  $V_{CC}$ ,  $T_A = -40^{\circ}C$  to  $+85^{\circ}C$ , unless otherwise noted. Typical values are  $V_{CC} = +5V$ ,  $V_L = +1.8V$  at  $T_A = +25^{\circ}C$ .) (Notes 2, 3)

PARAMETER	SYMBOL	CONDITIONS	MIN	TYP	MAX	UNITS
<b>DRIVER</b>						
Driver Propagation Delay (Figures 2 and 3)	$t_{DPLH}$	$C_L = 50pF$ , $R_{DIFF} = 54\Omega$			50	ns
	$t_{DPLH}$				50	
Driver Differential Output Rise or Fall Time	$t_R, t_F$	$C_L = 50pF$ , $R_L = 54\Omega$ , Figures 2 and 3			15	ns
Differential Driver Output Skew $ t_{DPLH} - t_{DPLH} $	$t_{DSKEW}$	$C_L = 50pF$ , $R_L = 54\Omega$ , Figures 2 and 3			8	ns
Maximum Data Rate			16			Mbps
Driver Enable to Output High	$t_{DZH}$	$C_L = 50pF$ , $R_L = 500\Omega$ , Figure 4			150	ns
Driver Enable to Output Low	$t_{DZL}$	$C_L = 50pF$ , $R_L = 500\Omega$ , Figure 5			150	ns
Driver Disable Time from Low	$t_{DLZ}$	$C_L = 50pF$ , $R_L = 500\Omega$ , Figure 4			100	ns
Driver Disable Time from High	$t_{DHZ}$	$C_L = 50pF$ , $R_L = 500\Omega$ , Figure 5			120	ns
Driver Enable from Shutdown to Output High	$t_{DZH}(SHDN)$	$C_L = 50pF$ , $R_L = 500\Omega$ , Figure 4			5	$\mu s$
Driver Enable from Shutdown to Output Low	$t_{DZL}(SHDN)$	$C_L = 50pF$ , $R_L = 500\Omega$ , Figure 5			5	$\mu s$
<b>RECEIVER</b>						
Receiver Propagation Delay (Figures 6 and 7)	$t_{RPLH}$	$C_L = 15pF$			80	ns
	$t_{RPHL}$				80	
Receiver Output Skew	$t_{RSKEW}$	$C_L = 15pF$ , Figures 6 and 7			13	ns
Maximum Data Rate			16			Mbps
Receiver Enable to Output Low	$t_{RZL}$	Figure 8			50	ns
Receiver Enable to Output High	$t_{RZH}$	Figure 8			50	ns
Receiver Disable Time from Low	$t_{RLZ}$	Figure 8			50	ns
Receiver Disable Time from High	$t_{RHZ}$	Figure 8			50	ns
Receiver Enable from Shutdown to Output High	$t_{RZH}(SHDN)$	Figure 8			5	$\mu s$
Receiver Enable from Shutdown to Output Low	$t_{RZL}(SHDN)$	Figure 8			5	$\mu s$
<b>DRIVER/RECEIVER</b>						
Time to Shutdown	$t_{SHDN}$		50	340	700	ns

# MAX13430E-MAX13433E

## RS-485 Transceivers with Low-Voltage Logic Interface

### SWITCHING CHARACTERISTICS (MAX13430E/MAX13432E (500kbps))

(V<sub>CC</sub> = +3V to +5.5V, V<sub>L</sub> = +1.8V to V<sub>CC</sub>, T<sub>A</sub> = -40°C to +85°C, unless otherwise noted. Typical values are V<sub>CC</sub> = +5V, V<sub>L</sub> = +1.8V at T<sub>A</sub> = +25°C.) (Notes 2, 3)

PARAMETER	SYMBOL	CONDITIONS	MIN	TYP	MAX	UNITS
<b>DRIVER</b>						
Driver Propagation Delay (Figures 2 and 3)	t <sub>DPLH</sub>	C <sub>L</sub> = 50pF, R <sub>L</sub> = 54Ω	180		800	ns
	t <sub>DPHL</sub>		180		800	
Driver Differential Output Rise or Fall Time	t <sub>R</sub> , t <sub>F</sub>	C <sub>L</sub> = 50pF, R <sub>L</sub> = 54Ω, Figures 2 and 3	200		800	ns
Differential Driver Output Skew  t <sub>DPLH</sub> - t <sub>DPHL</sub>	t <sub>DSKEW</sub>	C <sub>L</sub> = 50pF, R <sub>L</sub> = 54Ω, Figures 2 and 3			100	ns
Maximum Data Rate			500			kbps
Driver Enable to Output High	t <sub>DZH</sub>	C <sub>L</sub> = 50pF, R <sub>L</sub> = 500Ω, Figure 4			2.5	μs
Driver Enable to Output Low	t <sub>DZL</sub>	C <sub>L</sub> = 50pF, R <sub>L</sub> = 500Ω, Figure 5			2.5	μs
Driver Disable Time from Low	t <sub>DLZ</sub>	C <sub>L</sub> = 50pF, R <sub>L</sub> = 500Ω, Figure 4			100	ns
Driver Disable Time from High	t <sub>DHZ</sub>	C <sub>L</sub> = 50pF, R <sub>L</sub> = 500Ω, Figure 5			120	ns
Driver Enable from Shutdown to Output High	t <sub>DZH(SHDN)</sub>	C <sub>L</sub> = 50pF, R <sub>L</sub> = 500Ω, Figure 4			5	μs
Driver Enable from Shutdown to Output Low	t <sub>DZL(SHDN)</sub>	C <sub>L</sub> = 50pF, R <sub>L</sub> = 500Ω, Figure 5			5	μs
<b>RECEIVER</b>						
Receiver Propagation Delay (Figures 6 and 7)	t <sub>RPLH</sub>	C <sub>L</sub> = 15pF			200	ns
	t <sub>RPHL</sub>				200	
Receiver Output Skew	t <sub>RSKEW</sub>	C <sub>L</sub> = 15pF, Figures 6 and 7			30	ns
Maximum Data Rate			500			kbps
Receiver Enable to Output Low	t <sub>RZL</sub>	Figure 8			50	ns
Receiver Enable to Output High	t <sub>RZH</sub>	Figure 8			50	ns
Receiver Disable Time from Low	t <sub>RLZ</sub>	Figure 8			50	ns
Receiver Disable Time from High	t <sub>RHZ</sub>	Figure 8			50	ns
Receiver Enable from Shutdown to Output High	t <sub>RZH(SHDN)</sub>	Figure 8			5	μs
Receiver Enable from Shutdown to Output Low	t <sub>RZL(SHDN)</sub>	Figure 8			5	μs

# MAX13430E-MAX13433E

## RS-485 Transceivers with Low-Voltage Logic Interface

### SWITCHING CHARACTERISTICS (MAX13430E/MAX13432E (500kbps)) (continued)

( $V_{CC} = +3V$  to  $+5.5V$ ,  $V_L = +1.8V$  to  $V_{CC}$ ,  $T_A = -40^\circ C$  to  $+85^\circ C$ , unless otherwise noted. Typical values are  $V_{CC} = +5V$ ,  $V_L = +1.8V$  at  $T_A = +25^\circ C$ .) (Notes 2, 3)

PARAMETER	SYMBOL	CONDITIONS	MIN	TYP	MAX	UNITS
<b>DRIVER/RECEIVER</b>						
Time to Shutdown	$t_{SHDN}$		50	340	700	ns

**Note 2:** Parameters are 100% production tested at  $T_A = +25^\circ C$ , unless otherwise noted. Limits over temperature are guaranteed by design.

**Note 3:** All currents into the device are positive. All currents out of the device are negative. All voltages are referenced to device ground, unless otherwise noted.

**Note 4:**  $\Delta V_{OD}$  and  $\Delta V_{OC}$  are the changes in  $V_{OD}$  and  $V_{OC}$ , respectively, when the DI input changes state.

**Note 5:** The short-circuit output current is the peak current just prior to current limiting; the short-circuit foldback output current applies during current limiting to allow a recovery from bus contention.

### Typical Operating Characteristics

( $V_{CC} = +5V$ ,  $V_L = +5V$ ,  $T_A = +25^\circ C$ , unless otherwise noted.)

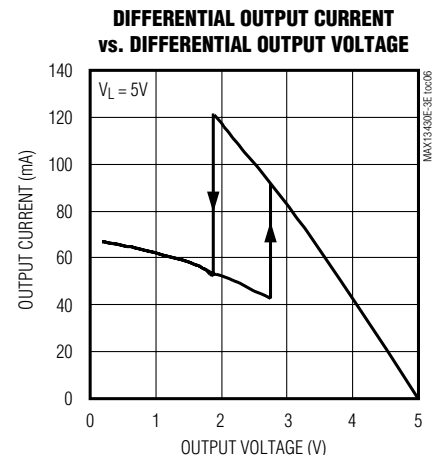
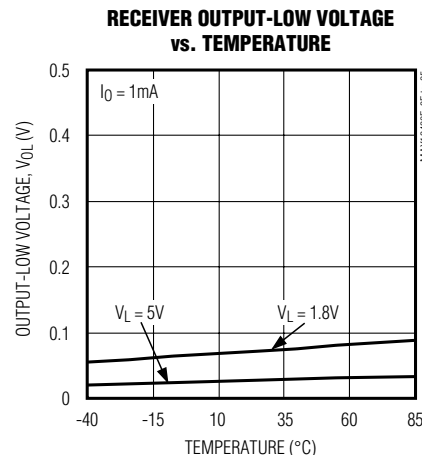
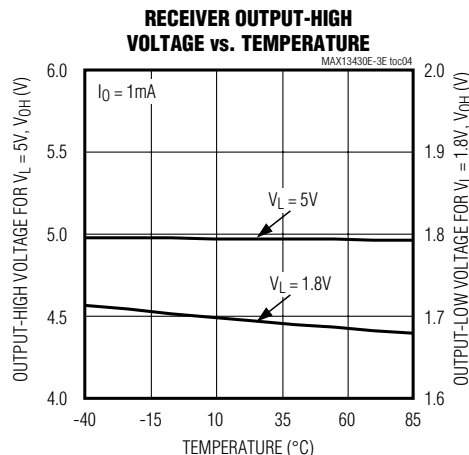

# MAX13430E-MAX13433E

## RS-485 Transceivers with Low-Voltage Logic Interface

### Typical Operating Characteristics (continued)

( $V_{CC} = +5V$ ,  $V_L = +5V$ ,  $T_A = +25^\circ C$ , unless otherwise noted.)

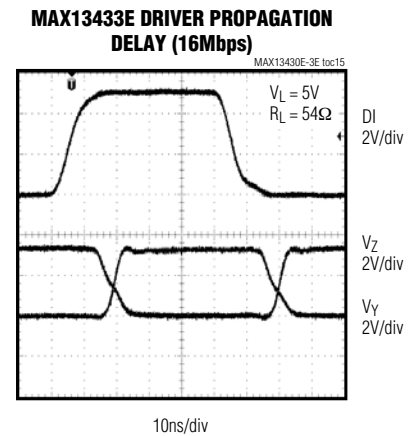
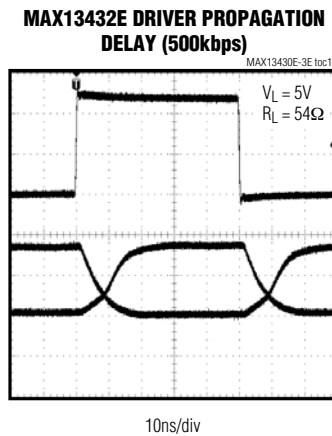
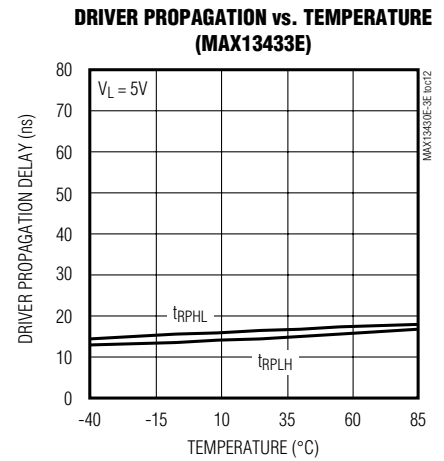

# MAX13430E-MAX13433E

## RS-485 Transceivers with Low-Voltage Logic Interface

### Test Circuits and Waveforms



Figure 1. Driver DC Test Load

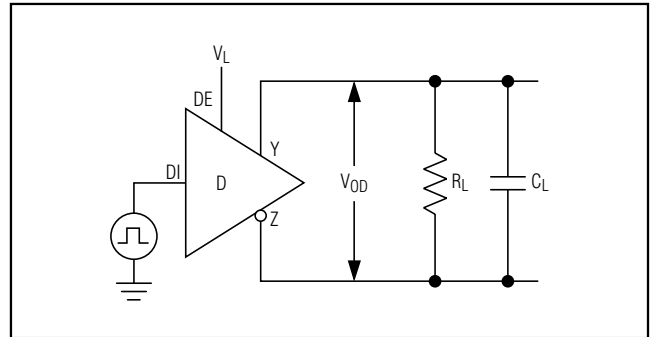

Figure 2. Driver Timing Test Circuit



Figure 3. Driver Propagation Delays



# MAX13430E-MAX13433E

## RS-485 Transceivers with Low-Voltage Logic Interface

### Test Circuits and Waveforms (continued)



Figure 4. Driver Enable and Disable Times ( $t_{DZH}$ ,  $t_{DZH(SHDN)}$ , and  $t_{DHZ}$ )



Figure 5. Driver Enable and Disable Times ( $t_{DZL}$ ,  $t_{DLZ}$ , and  $t_{DZL(SHDN)}$ )

# MAX13430E-MAX13433E

## RS-485 Transceivers with Low-Voltage Logic Interface

### Test Circuits and Waveforms (continued)



Figure 6. Receiver Propagation Delay Test Circuit



Figure 7. Receiver Propagation Delays



Figure 8. Receiver Enable and Disable Times

# MAX13430E-MAX13433E

## RS-485 Transceivers with Low-Voltage Logic Interface

### Pin Configurations



# MAX13430E-MAX13433E

## RS-485 Transceivers with Low-Voltage Logic Interface

### Pin Description

PIN		NAME	FUNCTION
MAX13430E/MAX13431E			
$\mu$ MAX	TDFN		
1	1	$V_L$	$V_L$ Input Logic-Supply Voltage. Bypass $V_L$ with a 0.1 $\mu$ F ceramic capacitor located as close as possible to the input.
2	2	RO	Receiver Output. When $\overline{RE}$ is low and if $(A - B) \geq -50\text{mV}$ , RO is high; if $(A - B) \leq -200\text{mV}$ , RO is low.
3	3	DE	Driver Output Enable. Drive DE high to enable driver outputs. These outputs are high impedance when DE is low. Drive $\overline{RE}$ high and DE low to enter low-power shutdown mode. DE is a hot-swap input (see the <i>Hot-Swap Capability</i> section for details.)
4	4	$\overline{RE}$	Active-Low Receiver Output Enable. Drive $\overline{RE}$ low to enable RO; RO is high impedance when $\overline{RE}$ is high. Drive $\overline{RE}$ high and DE low to enter low-power shutdown mode. $\overline{RE}$ is a hot-swap input (see the <i>Hot-Swap Capability</i> section for details.)
5	5	DI	Driver Input. With DE high, a low on DI forces noninverting output low and inverting output high. Similarly, a high on DI forces noninverting output high and inverting output low.
6	6	GND	Ground
7	7	N.C.	No Connection. Not internally connected. N.C. can be connected to GND.
8	8	A	Noninverting Receiver Input and Noninverting Driver Output
9	9	B	Inverting Receiver Input and Inverting Driver Output
10	10	$V_{CC}$	$V_{CC}$ Input Supply Voltage. Bypass $V_{CC}$ with a 1 $\mu$ F ceramic capacitor located as close as possible to the input for full ESD protection. If full ESD protection is not required, bypass $V_{CC}$ with a 0.1 $\mu$ F ceramic capacitor.
—	—	EP	Exposed Pad (TDFN Only). Connect EP to GND.

# MAX13430E–MAX13433E

## RS-485 Transceivers with Low-Voltage Logic Interface

### Pin Description (continued)

PIN		NAME	FUNCTION
MAX13432E/MAX13433E			
SO	TDFN		
1	1	V <sub>L</sub>	V <sub>L</sub> Input Logic Supply Voltage. Bypass V <sub>L</sub> with a 0.1µF ceramic capacitor located as close as possible to the input.
2	2	RO	Receiver Output. When $\overline{RE}$ is low and if (A - B) ≥ -50mV, RO is high; if (A - B) ≤ -200mV, RO is low.
3	3	DE	Driver Output Enable. Drive DE high to enable driver outputs. These outputs are high impedance when DE is low. Drive $\overline{RE}$ high and DE low to enter low-power shutdown mode. DE is a hot-swap input (see the <i>Hot-Swap Capability</i> section for details.)
4	4	$\overline{RE}$	Active-Low Receiver Output Enable. Drive $\overline{RE}$ low to enable RO; RO is high impedance when $\overline{RE}$ is high. Drive $\overline{RE}$ high and DE low to enter low-power shutdown mode. $\overline{RE}$ is a hot-swap input (see the <i>Hot-Swap Capability</i> section for details.)
5	5	DI	Driver Input. With DE high, a low on DI forces noninverting output low and inverting output high. Similarly, a high on DI forces noninverting output high and inverting output low.
6	6	GND	Ground
7, 13	7, 13	N.C.	No Connection. Not internally connected. N.C. can be connected to GND.
8	8	GND	Ground
9	9	Y	Noninverting Driver Output
10	10	Z	Inverting Driver Output
11	11	B	Inverting Receiver Input
12	12	A	Noninverting Receiver Input
14	14	V <sub>CC</sub>	V <sub>CC</sub> Input Supply Voltage. Bypass V <sub>CC</sub> with a 1µF ceramic capacitor located as close as possible to the input for full ESD protection. If full ESD protection is not required, bypass V <sub>CC</sub> with a 0.1µF ceramic capacitor.
—	—	EP	Exposed Pad (TDFN Only). Connect EP to GND.

# MAX13430E-MAX13433E

## RS-485 Transceivers with Low-Voltage Logic Interface

### Function Tables and Functional Diagrams

MAX13432E/MAX13433E (Full Duplex)

TRANSMITTING				
INPUTS			OUTPUTS	
$\overline{RE}$	DE	DI	Z	Y
X	1	1	0	1
X	1	0	1	0
0	0	X	High-Impedance	High-Impedance
1	0	X	Shutdown	
RECEIVING				
INPUTS			OUTPUT	
$\overline{RE}$	DE	A-B	RO	
0	X	$\geq -50mV$	1	
0	X	$\leq -200mV$	0	
0	X	Open/Shorted	1	
1	1	X	High-Impedance	
1	0	X	Shutdown	

MAX13430E/MAX13431E (Half Duplex)

TRANSMITTING				
INPUTS			OUTPUTS	
$\overline{RE}$	DE	DI	B	A
X	1	1	0	1
X	1	0	1	0
1	0	X	High-Impedance	High-Impedance
0	0	X	Shutdown*	
RECEIVING				
INPUTS			OUTPUT	
$\overline{RE}$	DE	A-B	RO	
0	X	$\geq -50mV$	1	
0	X	$\leq -200mV$	0	
0	X	Open/Shorted	1	
1	1	X	High-Impedance	
1	0	X	Shutdown*	

X = Don't care.

\*Shutdown mode, driver and receiver outputs are in high impedance.



Figure 9. Functional Diagrams

# MAX13430E–MAX13433E

## RS-485 Transceivers with Low-Voltage Logic Interface

### Detailed Description

The MAX13430E–MAX13433E are full- and half-duplex RS-485 transceivers that feature an adjustable low-voltage logic interface for application in multivoltage systems. This allows direct interfacing to low-voltage ASIC/FPGAs without extra components. The MAX13430E–MAX13433E RS-485 transceivers operate with a  $V_{CC}$  voltage supply from +3V to +5V. The low-voltage logic interface operates with a voltage supply from +1.62V to  $V_{CC}$ .

The MAX13430E–MAX13433E are  $\pm 30$ kV ESD-protected RS-485 transceivers with one driver and one receiver. All devices have a 1/8-unit load receiver input impedance, allowing up to 256 transceivers on the bus. These devices include fail-safe circuitry, guaranteeing a logic-high receiver output when receiver inputs are open or shorted. The receivers output a logic-high if all transmitters on a terminated bus are disabled (high impedance). All devices feature hot-swap capability to eliminate false transitions on the bus during power-up or hot insertion.

The MAX13430E/MAX13432E feature reduced slew-rate drivers that minimize EMI and reduce reflections caused by improperly terminated cables, allowing error-free data transmission up to 500kbps. The MAX13431E/MAX13433E driver slew rates are not limited, enabling data transmission up to 16Mbps.

The MAX13430E–MAX13433E transceivers draw 2mA of supply current when unloaded or when fully loaded with the drivers disabled. The MAX13430E/MAX13431E are intended for half-duplex communications, and the MAX13432E/MAX13433E are intended for full-duplex communications.

### Low-Voltage Logic Interface

$V_L$  is the voltage supply for the low-voltage logic interface and receiver output.  $V_L$  operates with voltage supply from +1.62V to  $V_{CC}$ .

### Fail Safe

The MAX13430E family guarantees a logic-high receiver output when the receiver inputs are shorted or open, or when they are connected to a terminated transmission line with all drivers disabled. This is done by setting the receiver input threshold between -50mV and -200mV. If the differential receiver input voltage ( $A - B$ ) is greater than or equal to -50mV, RO is logic-high.

If ( $A - B$ ) is less than or equal to -200mV, RO is logic-low. In the case of a terminated bus with all transmitters disabled, the receiver's differential input voltage is pulled to 0V by the termination. With the receiver thresholds of the MAX13430E family, this results in a logic-high with a 50mV minimum noise margin. The -50mV to -200mV threshold complies with the  $\pm 200$ mV EIA/TIA/RS-485 standard.

### Hot-Swap Capability

When circuit boards are inserted into a hot or powered backplane, differential disturbances to the data bus can lead to data errors. Upon initial circuit-board insertion, the data communication processor undergoes its own power-up sequence. During this period, the processor's logic-output drivers are high impedance and are unable to drive the DE and  $\overline{RE}$  inputs of these devices to a defined logic level. Leakage currents up to  $\pm 10\mu\text{A}$  from the high-impedance state of the processor's logic drivers could cause standard CMOS enable inputs of a transceiver to drift to an incorrect logic level. Additionally, parasitic circuit-board capacitance could cause coupling of  $V_L$  or GND to the enable inputs. Without the hot-swap capability, these factors could improperly enable the transceiver's driver or receiver. When  $V_L$  rises, an internal pulldown circuit holds DE low and  $\overline{RE}$  high. After the initial power-up sequence, the pulldown circuit becomes transparent, resetting the hot-swap tolerable input.

### $\pm 30$ kV ESD Protection

ESD-protection structures are incorporated on all pins to protect against electrostatic discharges encountered during handling and assembly. The driver outputs and receiver inputs of the MAX13430E family of devices have extra protection against static electricity. Maxim's engineers have developed state-of-the-art structures to protect these pins against ESD of  $\pm 30$ kV without damage. The ESD structures withstand high ESD in all states: normal operation, shutdown, and powered down. After an ESD event, the MAX13430E–MAX13433E keep working without latchup or damage. ESD protection can be tested in various ways. The transmitter outputs and receiver inputs of the MAX13430E–MAX13433E are characterized for protection to the following limits:

- $\pm 30$ kV using the Human Body Model
- $\pm 10$ kV using the Contact Discharge method specified in IEC 61000-4-2
- $\pm 15$ kV using the Air Gap Discharge method specified in IEC 61000-4-2

# MAX13430E-MAX13433E

## RS-485 Transceivers with Low-Voltage Logic Interface

### ESD Test Conditions

ESD performance depends on a variety of conditions. Contact Maxim for a reliability report that documents test setup, test methodology, and test results.

### Human Body Model

Figure 10a shows the Human Body Model, and Figure 10b shows the current waveform it generates when discharged into a low impedance. This model consists of a 100pF capacitor charged to the ESD voltage of interest, which is then discharged into the test device through a 1.5kΩ resistor.

### IEC 61000-4-2

The IEC 61000-4-2 standard covers ESD testing and performance of finished equipment. However, it does

not specifically refer to integrated circuits. The MAX13430E family of devices helps you design equipment to meet IEC 61000-4-2, without the need for additional ESD-protection components.

The major difference between tests done using the Human Body Model and IEC 61000-4-2 is higher peak current in IEC 61000-4-2 because series resistance is lower in the IEC 61000-4-2 model. Hence, the ESD withstand voltage measured to IEC 61000-4-2 is generally lower than that measured using the Human Body Model. Figure 10c shows the IEC 61000-4-2 model, and Figure 10d shows the current waveform for IEC 61000-4-2 ESD Contact Discharge test.



Figure 10a. Human Body ESD Test Model



Figure 10b. Human Body Current Waveform



Figure 10c. IEC 61000-4-2 ESD Test Model



Figure 10d. IEC 61000-4-2 ESD Generator Current Waveform



# **MAX13430E–MAX13433E**

## **RS-485 Transceivers with Low-Voltage Logic Interface**

### **Applications Information**

#### **256 Transceivers on the Bus**

The standard RS-485 receiver input impedance is a one-unit load ( $12k\Omega$ ), and the standard driver can drive up to 32 unit loads. The MAX13430E family of transceivers has a 1/8-unit load receiver input impedance ( $96k\Omega$ ), allowing up to 256 transceivers to be connected in parallel on one communication line. Any combination of these devices, as well as other RS-485 transceivers with a total of 32-unit loads or less, can be connected to the line.

#### **Reduced EMI and Reflections**

The MAX13430E/MAX13432E feature reduced slew-rate drivers that minimize EMI and reduce reflections caused by improperly terminated cables, allowing error-free data transmission up to 500kbps.

#### **Driver Output Protection**

Two mechanisms prevent excessive output current and power dissipation caused by faults or by bus contention. The first, a foldback current limit on the output stage, provides immediate protection against short circuits over the whole common-mode voltage range (see the *Typical Operating Characteristics*.) The second, a thermal-shutdown circuit, forces the driver outputs into a high-impedance state if the die temperature exceeds  $+150^{\circ}\text{C}$  (typ).

#### **Typical Applications**

The MAX13430E/MAX13433E transceivers are designed for bidirectional data communications on multipoint bus transmission lines. Figures 11 and 12 show typical network applications circuits. To minimize reflections, terminate the line at both ends with its characteristic impedance, and keep stub lengths off the main line as short as possible. The slew-rate-limited MAX13430E/MAX13432E allow the RS-485 network to be more tolerant of imperfect termination.

# MAX13430E-MAX13433E

## RS-485 Transceivers with Low-Voltage Logic Interface

### Typical Application Circuits



Figure 11. Typical Half-Duplex RS-485 Network



Figure 12. Typical Full-Duplex RS-485 Network

# **MAX13430E-MAX13433E**

## **RS-485 Transceivers with Low-Voltage Logic Interface**

### **Chip Information**

PROCESS: BICMOS

### **Package Information**

For the latest package outline information and land patterns, go to [www.maxim-ic.com/packages](http://www.maxim-ic.com/packages). Note that a "+", "#", or "-" in the package code indicates RoHS status only. Package drawings may show a different suffix character, but the drawing pertains to the package regardless of RoHS status.

<b>PACKAGE TYPE</b>	<b>PACKAGE CODE</b>	<b>DOCUMENT NO.</b>
10 $\mu$ MAX	U10-2	<a href="#">21-0061</a>
14 TDFN-EP	T1433-2	<a href="#">21-0137</a>
10 TDFN-EP	T1033-1	<a href="#">21-0137</a>
14 SO	S14-1	<a href="#">21-0041</a>

# MAX13430E-MAX13433E

## RS-485 Transceivers with Low-Voltage Logic Interface

### Revision History

REVISION NUMBER	REVISION DATE	DESCRIPTION	PAGES CHANGED
0	10/08	Initial release	—
1	5/09	Updated <i>Ordering Information</i>	1
2	5/10	Added an automotive temperature grade part to the <i>Ordering Information</i>	1



Maxim cannot assume responsibility for use of any circuitry other than circuitry entirely embodied in a Maxim product. No circuit patent licenses are implied. Maxim reserves the right to change the circuitry and specifications without notice at any time. The parametric values (min and max limits) shown in the Electrical Characteristics table are guaranteed. Other parametric values quoted in this data sheet are provided for guidance.