

6500V_{RMS} Isolated RS485/RS422 μ Module Transceiver + Power

FEATURES

- **RS485/RS422 Transceiver: 6500V_{RMS} for 1 Minute**
- **CSA (IEC/UL) Approved, File #255632**
- **Isolated DC Power: 5V at 200mA**
- **No External Components Required**
- **20Mbps or Low EMI 250kbps Data Rate**
- **High ESD: ± 15 kV HBM on Transceiver Interface**
- **High Common Mode Transient Immunity: 50kV/ μ s**
- **Integrated Selectable 120 Ω Termination**
- Extended Creepage and Clearance ~14.6mm
- 1.62V to 5.5V Logic Supply Pin for Flexible Digital Interface
- Maximum Continuous Working Voltage: 690V_{RMS}
- High Input Impedance Failsafe RS485 Receiver
- Current Limited Drivers and Thermal Shutdown
- Compatible with TIA/EIA-485-A and PROFIBUS
- High Impedance Output During Internal Fault Condition
- Low Current Shutdown Mode (< 10 μ A)
- General Purpose CMOS Isolated Channel
- 22mm \times 9mm \times 5.16mm Surface Mount BGA Package

APPLICATIONS

- Isolated RS485/RS422 Interface
- Industrial Networks
- Breaking RS485 Ground Loops
- Isolated PROFIBUS-DP Networks

DESCRIPTION

The **LTM[®]2885** is a complete galvanically isolated full-duplex RS485/RS422 μ Module[®] (micromodule) transceiver. No external components are required. A single supply powers both sides of the interface through an integrated, isolated, low noise, efficient 5V output DC/DC converter.

Coupled inductors and an isolation power transformer provide 6500V_{RMS} of isolation between the line transceiver and the logic interface. This device is ideal for systems where the ground loop is broken allowing for large common mode voltage variation. Uninterrupted communication is guaranteed for common mode transients up to 50kV/ μ s.

Maximum data rates are 20Mbps or 250kbps in slew limited mode. Transmit data, DI, and receive data, RO, are implemented with event driven low jitter processing. The receiver has a one-eighth unit load supporting up to 256 nodes per bus. A logic supply pin allows easy interfacing with different logic levels from 1.62V to 5.5V, independent of the main supply.

Enhanced ESD protection allows this part to withstand up to ± 15 kV (human body model) on the transceiver interface pins to isolated supplies and ± 25 kV through the isolation barrier to logic supplies without latch-up or damage.

All registered trademarks and trademarks are the property of their respective owners.

TYPICAL APPLICATION

Isolated Half-Duplex RS485 μ Module Transceiver

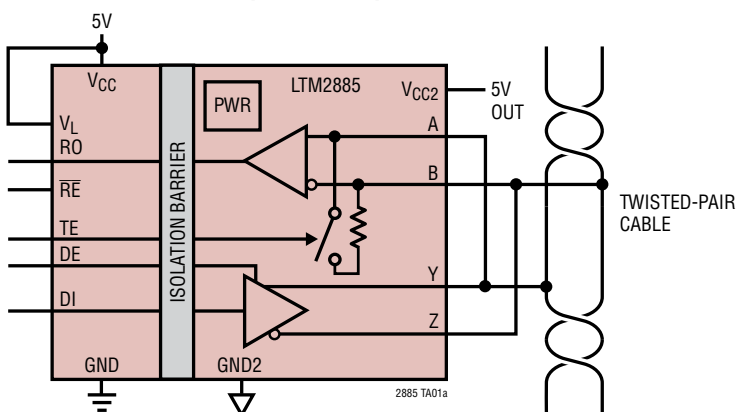

LTM2885 Operating Through 100kV/ μ s CM Transients

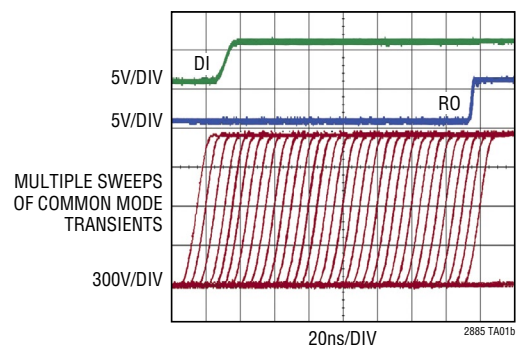

LTM2885

ABSOLUTE MAXIMUM RATINGS

(Note 1)

V_{CC} to GND	-0.3V to 6V
V_{CC2} to GND2.....	-0.3V to 6V
V_L to GND	-0.3V to 6V
Interface Voltages	
(A, B, Y, Z) to GND2.....	$V_{CC2} - 15V$ to 15V
(A-B) with Terminator Enabled.....	$\pm 6V$
Signal Voltages ON, RO, DI, DE,	
\overline{RE} , TE, D_{OUT} to GND.....	-0.3V to $V_L + 0.3V$

Signal Voltages \overline{SLO} ,	
D_{IN} to GND2.....	-0.3V to $V_{CC2} + 0.3V$
Operating Temperature Range (Note 4)	
LTM2885C	0°C to 70°C
LTM2885I	-40°C to 85°C
LTM2885H.....	-40°C to 105°C
Maximum Internal Operating Temperature..... 125°C	
Storage Temperature Range	
	-55°C to 125°C
Peak Body Reflow Temperature	
	245°C

PIN CONFIGURATION

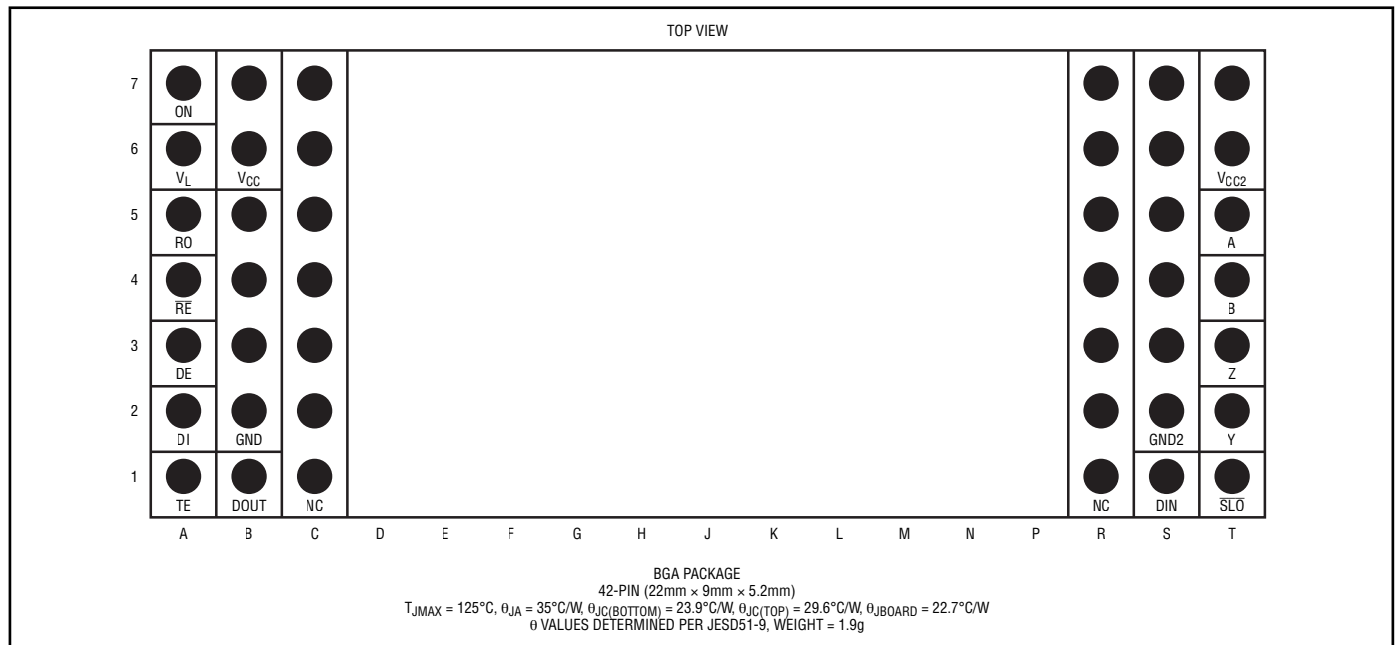

ORDER INFORMATION

PART NUMBER	PAD OR BALL FINISH	PART MARKING		PACKAGE TYPE	MSL RATING	TEMPERATURE RANGE
		DEVICE	FINISH CODE			
LTM2885CY#PBF	SAC305 (RoHS)	LTM2885Y	e1	42-BGA	3	0°C to 70°C
LTM2885IY#PBF						-40°C to 85°C
LTM2885HY#PBF						-40°C to 105°C

- Contact the factory for parts specified with wider operating temperature ranges. *Pad or ball finish code is per IPC/JEDEC J-STD-609.
- [Recommended LGA and BGA PCB Assembly and Manufacturing Procedures](#)
- [LGA and BGA Package and Tray Drawings](#)

ELECTRICAL CHARACTERISTICS The ● denotes the specifications which apply over the full operating temperature range, otherwise specifications are at $T_A = 25^\circ\text{C}$. $V_{CC} = 5.0\text{V}$, $V_L = 3.3\text{V}$, $\text{GND} = \text{GND2} = 0\text{V}$, $\text{ON} = V_L$ unless otherwise noted.

SYMBOL	PARAMETER	CONDITIONS		MIN	TYP	MAX	UNITS
Power Supply							
V_{CC}	V_{CC} Supply Voltage		●	4.5	5.0	5.5	V
V_L	V_L Supply Voltage		●	1.62		5.5	V
I_{CCPOFF}	V_{CC} Supply Current in Off Mode	$\text{ON} = 0\text{V}$	●		0	10	μA
I_{CCS}	V_{CC} Supply Current in On Mode	$\text{DE} = 0\text{V}$, $\overline{\text{RE}} = V_L$, No Load	●		38	50	mA
V_{CC2}	Regulated V_{CC2} Output Voltage, Loaded	$\text{DE} = 0\text{V}$, $\overline{\text{RE}} = V_L$, $I_{\text{LOAD}} = 150\text{mA}$	●	4.75	5.0		V
$V_{CC2\text{NOLOAD}}$	Regulated V_{CC2} Output Voltage, No Load	$\text{DE} = 0\text{V}$, $\overline{\text{RE}} = V_L$, No Load		4.8	5.0	5.35	V
	Efficiency	$I_{CC2} = 100\text{mA}$ (Note 2)			50		%
I_{CC2S}	V_{CC2} Short-Circuit Current	$\text{DE} = 0\text{V}$, $\overline{\text{RE}} = V_L$, $V_{CC2} = 0\text{V}$			200		mA
Driver							
$ V_{OD} $	Differential Driver Output Voltage	$R = \infty$ (Figure 1) $R = 27\Omega$ (RS485) (Figure 1) $R = 50\Omega$ (RS422) (Figure 1)	● ● ●			V_{CC2} V_{CC2} V_{CC2}	V V V
$\Delta V_{OD} $	Difference in Magnitude of Driver Differential Output Voltage for Complementary Output States	$R = 27\Omega$ or $R = 50\Omega$ (Figure 1)	●			0.2	V
V_{OC}	Driver Common Mode Output Voltage	$R = 27\Omega$ or $R = 50\Omega$ (Figure 1)	●			3	V
$\Delta V_{OC} $	Difference in Magnitude of Driver Common Mode Output Voltage for Complementary Output States	$R = 27\Omega$ or $R = 50\Omega$ (Figure 1)	●			0.2	V
I_{OZD}	Driver Three-State (High Impedance) Output Current on Y and Z	$\text{DE} = 0\text{V}$, (Y or Z) = -7V , $+12\text{V}$	●			± 10	μA
		$\text{DE} = 0\text{V}$, (Y or Z) = -7V , $+12\text{V}$, H-Grade	●			± 50	μA
I_{OSD}	Maximum Driver Short-Circuit Current	$-7\text{V} \leq (\text{Y or Z}) \leq 12\text{V}$ (Figure 2)	●	-250		250	mA
Receiver							
R_{IN}	Receiver Input Resistance	$\overline{\text{RE}} = 0\text{V}$ or V_L , $V_{IN} = -7\text{V}$, -3V , 3V , 7V , 12V (Figure 3)	●	96	125		k Ω
		$\overline{\text{RE}} = 0\text{V}$ or V_L , $V_{IN} = -7\text{V}$, -3V , 3V , 7V , 12V (Figure 3), H-Grade	●	48	125		k Ω
R_{TE}	Receiver Termination Resistance Enabled	$\text{TE} = V_L$, $V_{AB} = 2\text{V}$, $V_B = -7\text{V}$, 0V , 10V (Figure 8)	●	105	120	156	Ω
I_{IN}	Receiver Input Current (A, B)	$\text{ON} = 0\text{V}$ $V_{CC2} = 0\text{V}$ or 5V , $V_{IN} = 12\text{V}$ (Figure 3)	●			125	μA
		$\text{ON} = 0\text{V}$ $V_{CC2} = 0\text{V}$ or 5V , $V_{IN} = 12\text{V}$ (Figure 3), H-Grade	●			250	μA
		$\text{ON} = 0\text{V}$ $V_{CC2} = 0\text{V}$ or 5V , $V_{IN} = -7\text{V}$ (Figure 3)	●	-100			μA
		$\text{ON} = 0\text{V}$ $V_{CC2} = 0\text{V}$ or 5V , $V_{IN} = -7\text{V}$ (Figure 3), H-Grade	●	-145			μA
V_{TH}	Receiver Differential Input Threshold Voltage (A-B)	$-7\text{V} \leq B \leq 12\text{V}$	●	-0.2		0.2	V
ΔV_{TH}	Receiver Input Failsafe Hysteresis	$B = 0\text{V}$			25		mV
	Receiver Input Failsafe Threshold	$B = 0\text{V}$		-0.2	-0.05	0	V

ELECTRICAL CHARACTERISTICS The ● denotes the specifications which apply over the full operating temperature range, otherwise specifications are at $T_A = 25^\circ\text{C}$. $V_{CC} = 5.0\text{V}$, $V_L = 3.3\text{V}$, $\text{GND} = \text{GND2} = 0\text{V}$, $\text{ON} = V_L$ unless otherwise noted.

SYMBOL	PARAMETER	CONDITIONS	MIN	TYP	MAX	UNITS
Logic						
V_{IL}	Logic Input Low Voltage	$1.62\text{V} \leq V_L \leq 5.5\text{V}$	●		0.4	V
V_{IH}	Logic Input High Voltage	D_{IN} $\overline{\text{SLO}}$ $\text{DI, TE, DE, ON, } \overline{\text{RE}}$ $V_L \geq 2.35\text{V}$ $1.62\text{V} \leq V_L < 2.35\text{V}$	●	$0.67 \cdot V_{CC2}$		V
			●	2		V
			●	$0.67 \cdot V_L$		V
			●	$0.75 \cdot V_L$		V
I_{INL}	Logic Input Current		●	0	± 1	μA
V_{HYS}	Logic Input Hysteresis	(Note 2)		150		mV
V_{OH}	Output High Voltage	Output High, $I_{LOAD} = -4\text{mA}$ (Sourcing), $5.5\text{V} \geq V_L \geq 3\text{V}$ Output High, $I_{LOAD} = -1\text{mA}$ (Sourcing), $1.62\text{V} \leq V_L < 3\text{V}$	●	$V_L - 0.4$		V
			●	$V_L - 0.4$		V
V_{OL}	Output Low Voltage	Output Low, $I_{LOAD} = 4\text{mA}$ (Sinking), $5.5\text{V} \geq V_L \geq 3\text{V}$ Output High, $I_{LOAD} = 1\text{mA}$ (Sinking), $1.62\text{V} \leq V_L < 3\text{V}$	●		0.4	V
			●		0.4	V
I_{OZR}	Three-State (High Impedance) Output Current on RO	$\overline{\text{RE}} = V_L$, $0\text{V} \leq \text{RO} \leq V_L$	●		± 1	μA
I_{OSR}	Short-Circuit Current	$0\text{V} \leq (\text{RO or } D_{OUT}) \leq V_L$	●		± 85	mA
ESD (HBM) (Note 2)						
	RS485 Driver and Receiver Protection	(Y, Z, A, B) to (GND, GND2)			± 15	kV
	Isolation Boundary	(V_{CC2} , GND2) to (V_{CC} , V_L , GND)			± 25	kV

SWITCHING CHARACTERISTICS The ● denotes the specifications which apply over the full operating temperature range, otherwise specifications are at $T_A = 25^\circ\text{C}$. $V_{CC} = 5.0\text{V}$, $V_L = 3.3\text{V}$, $\text{GND} = \text{GND2} = 0\text{V}$, $\text{ON} = V_L$ unless otherwise noted.

SYMBOL	PARAMETER	CONDITIONS	MIN	TYP	MAX	UNITS
Driver $\overline{\text{SLO}} = V_{CC2}$						
f_{MAX}	Maximum Data Rate	(Note 3)	20			Mbps
t_{PLHD} t_{PHLD}	Driver Input to Output	$R_{\text{DIFF}} = 54\Omega$, $C_L = 100\text{pF}$ (Figure 4)	●	60	85	ns
Δt_{PD}	Driver Input to Output Difference $ t_{\text{PLHD}} - t_{\text{PHLD}} $	$R_{\text{DIFF}} = 54\Omega$, $C_L = 100\text{pF}$ (Figure 4)	●	1	8	ns
t_{SKEWD}	Driver Output Y to Output Z	$R_{\text{DIFF}} = 54\Omega$, $C_L = 100\text{pF}$ (Figure 4)	●	1	± 8	ns
t_{RD} t_{FD}	Driver Rise or Fall Time	$R_{\text{DIFF}} = 54\Omega$, $C_L = 100\text{pF}$ (Figure 4)	●	4	12.5	ns
t_{ZLD} , t_{ZHD} , t_{LZD} , t_{HZD}	Driver Output Enable or Disable Time	$R_L = 500\Omega$, $C_L = 50\text{pF}$ (Figure 5)	●		170	ns
Driver $\overline{\text{SLO}} = \text{GND2}$						
f_{MAX}	Maximum Data Rate	(Note 3)	250			kbps
t_{PLHD} t_{PHLD}	Driver Input to Output	$R_{\text{DIFF}} = 54\Omega$, $C_L = 100\text{pF}$ (Figure 4)		1	1.55	μs
Δt_{PD}	Driver Input to Output Difference $ t_{\text{PLHD}} - t_{\text{PHLD}} $	$R_{\text{DIFF}} = 54\Omega$, $C_L = 100\text{pF}$ (Figure 4)		50	500	ns
t_{SKEWD}	Driver Output Y to Output Z	$R_{\text{DIFF}} = 54\Omega$, $C_L = 100\text{pF}$ (Figure 4)		± 200	± 750	ns
t_{RD} t_{FD}	Driver Rise or Fall Time	$R_{\text{DIFF}} = 54\Omega$, $C_L = 100\text{pF}$ (Figure 4)	●	0.9	1.5	μs
t_{ZLD} , t_{ZHD} , t_{LZD} , t_{HZD}	Driver Output Enable or Disable Time	$R_L = 500\Omega$, $C_L = 50\text{pF}$ (Figure 5)	●		400	ns
Receiver						
t_{PLHR} t_{PHLR}	Receiver Input to Output	$C_L = 15\text{pF}$, $V_{\text{CM}} = 2.5\text{V}$, $ V_{\text{AB}} = 1.4\text{V}$, t_{R} and $t_{\text{F}} < 4\text{ns}$, (Figure 6)	●	100	140	ns
t_{SKEWR}	Differential Receiver Skew $ t_{\text{PLHR}} - t_{\text{PHLR}} $	$C_L = 15\text{pF}$ (Figure 6)	●	1	8	ns
t_{RR} t_{FR}	Receiver Output Rise or Fall Time	$C_L = 15\text{pF}$ (Figure 6)	●	3	12.5	ns
t_{ZLR} , t_{ZHR} , t_{LZR} , t_{HZR}	Receiver Output Enable or Disable Time	$R_L = 1\text{k}\Omega$, $C_L = 15\text{pF}$ (Figure 7)	●		50	ns
t_{RTEN} , t_{RTZ}	Termination Enable or Disable Time	$\overline{\text{RE}} = 0\text{V}$, $\text{DE} = 0\text{V}$, $V_{\text{AB}} = 2\text{V}$, $V_{\text{B}} = 0\text{V}$ (Figure 8)	●		100	μs
Generic Logic Input						
t_{PLHL1} t_{PHLL1}	D_{IN} to D_{OUT} Input to Output	$C_L = 15\text{pF}$, t_{R} and $t_{\text{F}} < 4\text{ns}$	●	60	100	ns
Power Supply Generator						
	$V_{\text{CC2}} - \text{GND2}$ Supply Start-Up Time (0V to 4.5V)	$\text{ON} \rightarrow V_L$, No Load	●	200	500	μs

ISOLATION CHARACTERISTICS $T_A = 25^\circ\text{C}$

SYMBOL	PARAMETER	CONDITIONS	MIN	TYP	MAX	UNITS
V_{ISO}	Rated Dielectric Insulation Voltage	1 Minute (Derived from 1 Second Test)	6500			V_{RMS}
		1 Second (Notes 5, 6, 7)	7800			V_{RMS}
	Common Mode Transient Immunity	$V_{CC} = 5V$, $V_L = 0N = 3.3V$, $\Delta V_{CM} = 1kV$, $\Delta T = 20ns$ (Note 2)	50			$kV/\mu s$
V_{IORM}	Maximum Working Insulation Voltage	(Note 2)	1000 690			V_{PEAK} , V_{DC} V_{RMS}
	Partial Discharge	$V_{PR} = 1300V_{RMS}$ (Notes 2, 5)			5	pC
CTI	Comparative Tracking Index	IEC 60112 (Note 2)	600			V_{RMS}
	Depth of Erosion	IEC 60112 (Note 2)		0.017		mm
DTI	Distance Through Insulation	(Note 2)		0.2		mm
	Input to Output Resistance	(Notes 2, 5)	1	5		$T\Omega$
	Input to Output Capacitance	(Notes 2, 5)		6		pF
	Creepage Distance	(Notes 2, 5)		14.6		mm

REGULATORY INFORMATION**CSA (Note 8)**

CSA 60950-1-07+A1+A2 and IEC 60950-1, second edition, +A1 +A2:

Basic Insulation at $1440V_{RMS}$

Reinforced Insulation at $720V_{RMS}$

CSA 62368-1-14 and IEC 62368-1-14:2014, second edition:

Basic Insulation at $600V_{RMS}$

Reinforced Insulation at $300V_{RMS}$

CSA 60601-1:14 and IEC 60601-1, third edition, +A1:

Two means of patient protection (2 MOPP) at $250V_{RMS}$

UL 1577-2015:

Single Protection, $6500V_{RMS}$ Isolation Voltage

File 255632

Note 1: Stresses beyond those listed under Absolute Maximum Ratings may cause permanent damage to the device. Exposure to any Absolute Maximum Rating condition for extended periods may affect device reliability and lifetime.

Note 2: Guaranteed by design and not subject to production test.

Note 3: Maximum Data rate is guaranteed by other measured parameters and is not tested directly.

Note 4: This μ Module transceiver includes over temperature protection that is intended to protect the device during momentary overload conditions. Junction temperature will exceed 125°C when over temperature protection is active. Continuous operation above specified maximum operating junction temperature may result in device degradation or failure.

Note 5: Device considered a 2-terminal device. Pin group A1 through C7 shorted together and pin group R1 through T7 shorted together.

Note 6: The rated dielectric insulation voltage should not be interpreted as a continuous voltage rating.

Note 7: In accordance with UL1577, each device is proof tested for the 1 minute RMS rating by applying the equivalent RMS voltage multiplied by an acceleration factor of 1.2 for one second.

Note 8: Ratings are for pollution degree 2, material group 3 and overvoltage category II where applicable. Ratings for other environmental and electrical conditions to be determined from the appropriate safety standard.

TYPICAL PERFORMANCE CHARACTERISTICS $T_A = 25^\circ\text{C}$, $V_{CC} = 5.0\text{V}$, $V_L = 3.3\text{V}$ unless otherwise noted.

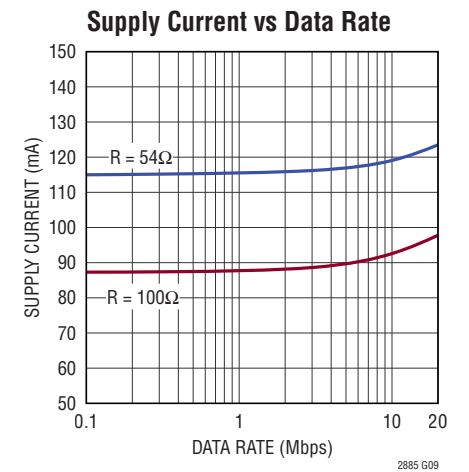
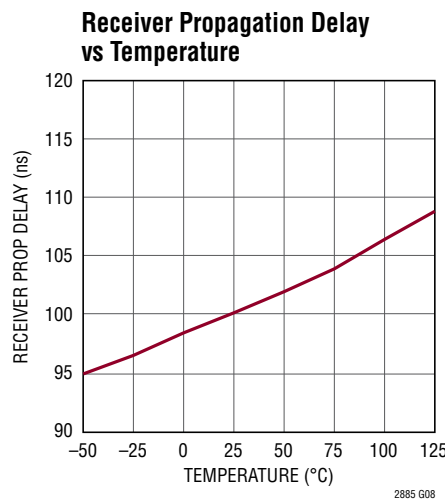
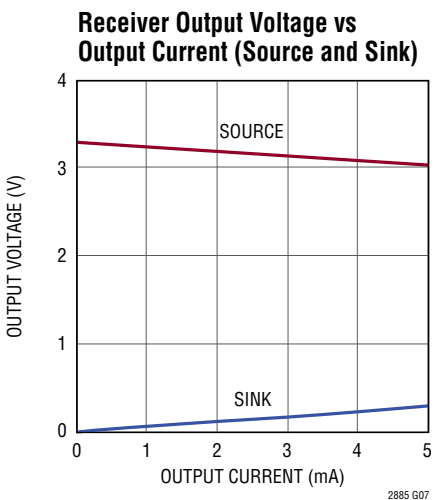
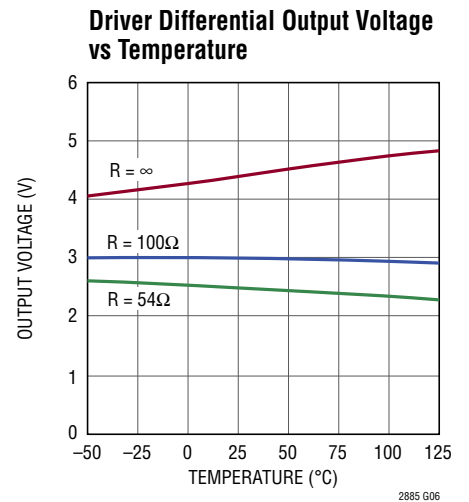
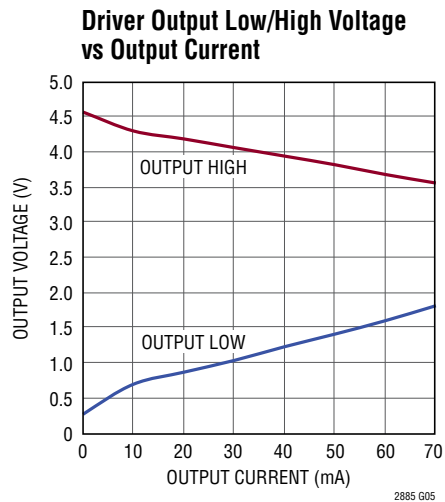
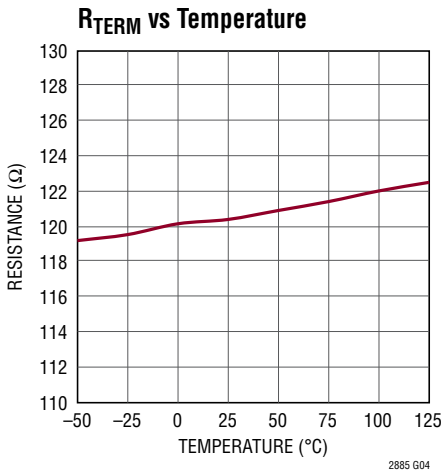
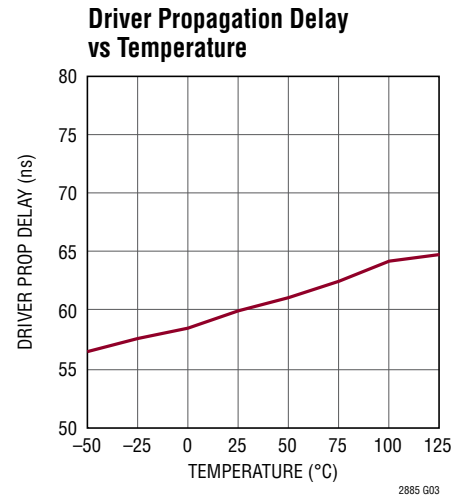
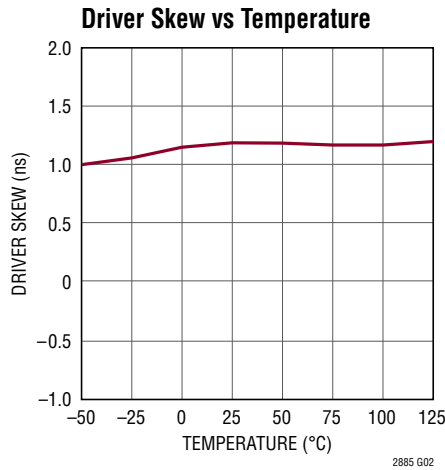
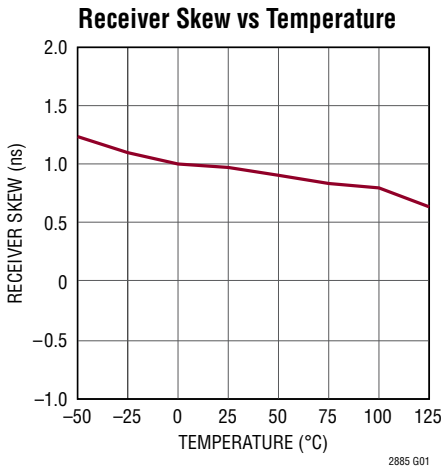

TYPICAL PERFORMANCE CHARACTERISTICS $T_A = 25^\circ\text{C}$, $V_{CC} = 5.0\text{V}$, $V_L = 3.3\text{V}$ unless otherwise noted.

V_{CC} Supply Current vs Temperature at $I_{LOAD} = 100\text{mA}$ on V_{CC2}

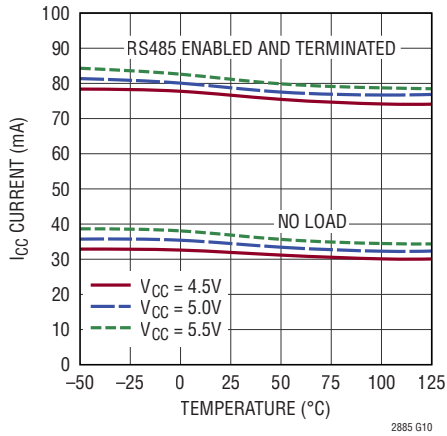

Available V_{CC2} Current vs Temperature

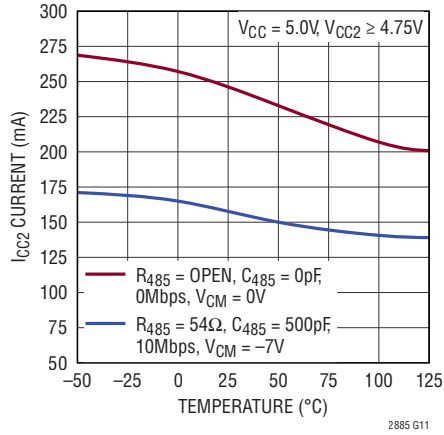

V_{CC2} vs Load Current

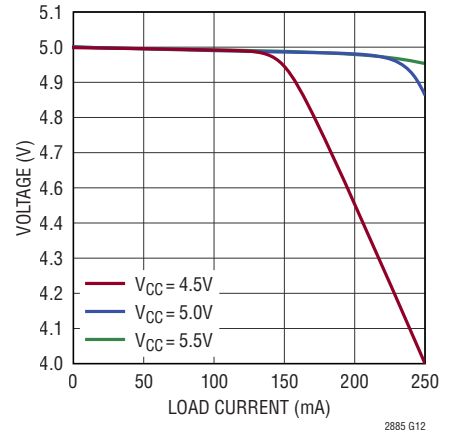

V_{CC2} Efficiency and Power Loss vs Load Current

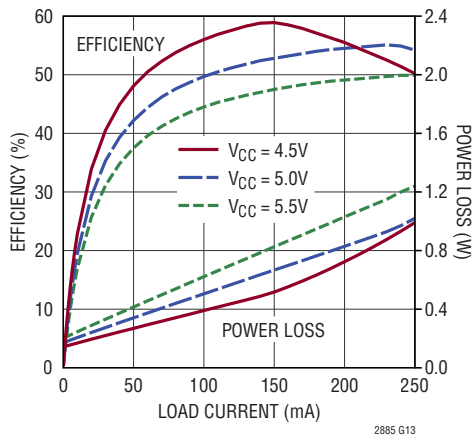

V_{CC2} Load Step (100mA)

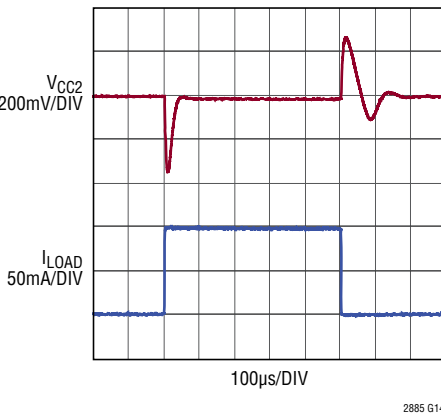

V_{CC2} Noise

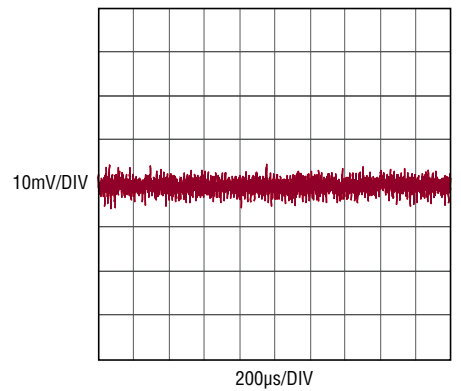

PIN FUNCTIONS

LOGIC SIDE

TE (Pin A1): Terminator Enable. A logic high enables a termination resistor (typically 120 Ω) between pins A and B. Do not float.

DI (Pin A2): Driver Input. If the driver outputs are enabled (DE high), then a low on DI forces the driver noninverting output (Y) low and the inverting output (Z) high. A high on DI, with the driver outputs enabled, forces the driver noninverting output (Y) high and inverting output (Z) low. Do not float.

DE (Pin A3): Driver Enable. A logic low disables the driver leaving the outputs Y and Z in a high impedance state. A logic high enables the driver. Do not float.

\overline{RE} (Pin A4): Receiver Enable. A logic low enables the receiver output. A logic high disables RO to a high impedance state. Do not float.

RO (Pin A5): Receiver Output. If the receiver output is enabled (\overline{RE} low) and if $A - B$ is $> 200\text{mV}$, RO is a logic high, if $A - B$ is $< 200\text{mV}$ RO is a logic low. If the receiver inputs are open, shorted, or terminated without a valid signal for more than approximately 3 μs , RO is a logic high. Under the condition of an isolation communication failure RO is in a high impedance state.

V_L (Pin A6): Logic Supply. Interface supply voltage for pins RO, \overline{RE} , TE, DI, DE, D_{OUT} , and ON. Recommended operating voltage is 1.62V to 5.5V. Internally bypassed to GND with 2.2 μF .

ON (Pin A7): Enable. Enables power and data communication through the isolation barrier. If ON is high the part is enabled and power and communications are functional to the isolated side. If ON is low the logic side is held in reset and the isolated side is unpowered. Do not float.

D_{OUT} (Pin B1): General Purpose Logic Output. Logic output connected through isolation path to D_{IN} . Under the condition of an isolation communication failure D_{OUT} is in a high impedance state.

GND (Pins B2-B5): Circuit Ground.

V_{CC} (Pins B6-B7): Supply Voltage. Recommended operating voltage is 4.5V to 5.5V. Internally bypassed to GND with 2.2 μF .

NC (Pins C1-C7): No Connect. Pins with no internal connection.

ISOLATED SIDE

NC (Pins R1-R7): No Connect. Pins with no internal connection.

D_{IN} (Pin S1): General Purpose Isolated Logic Input. Logic input on the isolated side relative to V_{CC2} and GND2. A logic high on D_{IN} will generate a logic high on D_{OUT} . A logic low on D_{IN} will generate a logic low on D_{OUT} . Do not float.

GND2 (Pins S2-S7): Isolated Side Circuit Ground. The pads should be connected to the isolated ground and/or cable shield.

\overline{SLO} (Pin T1): Driver Slew Rate Control. A low input, relative to GND2, will force the driver into a reduced slew rate mode for reduced EMI. A high input, relative to GND2, puts the driver into full speed mode to support maximum data rates. Do not float.

Y (Pin T2): Noninverting Driver Output. High impedance when the driver is disabled.

Z (Pin T3): Inverting Driver Output. High impedance when the driver is disabled.

B (Pin T4): Inverting Receiver Input. Impedance is $> 96\text{k}\Omega$ in all modes, powered and unpowered.

A (Pin T5): Noninverting Receiver Input. Impedance is $> 96\text{k}\Omega$ in all modes, powered and unpowered.

V_{CC2} (Pins T6-T7): Isolated Supply Voltage. Internally generated from V_{CC} by an isolated DC/DC converter and regulated to 5V. Internally bypassed to GND2 with 2.2 μF .

BLOCK DIAGRAM

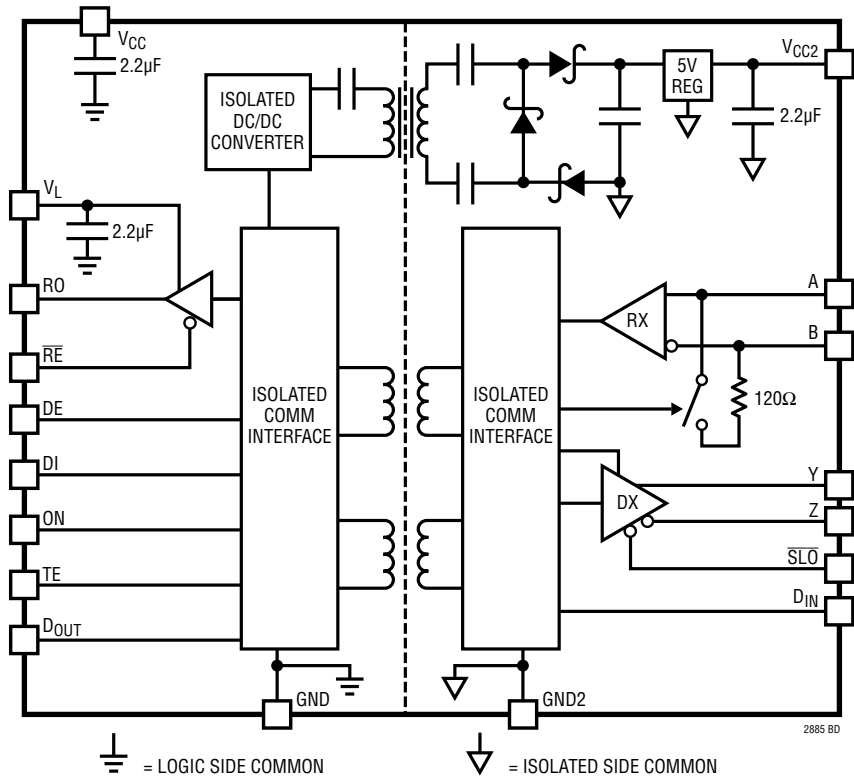

TEST CIRCUITS

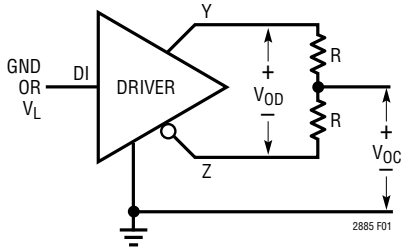

Figure 1. Driver DC Characteristics

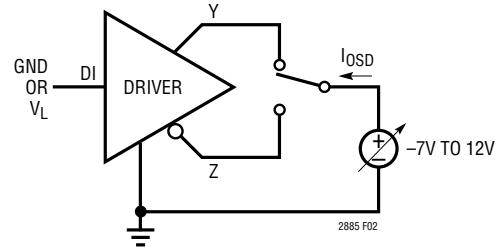

Figure 2. Driver Output Short-Circuit Current

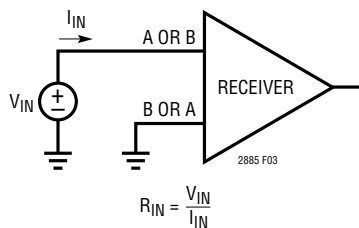

Figure 3. Receiver Input Current and Input Resistance

TEST CIRCUITS

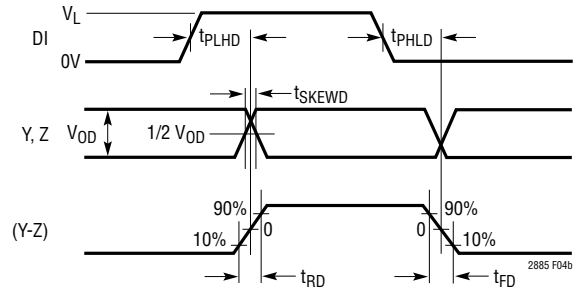
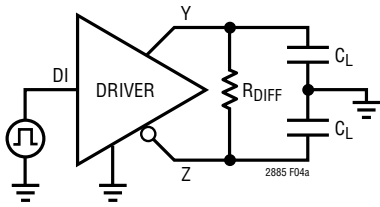

Figure 4. Driver Timing Measurement Receiver

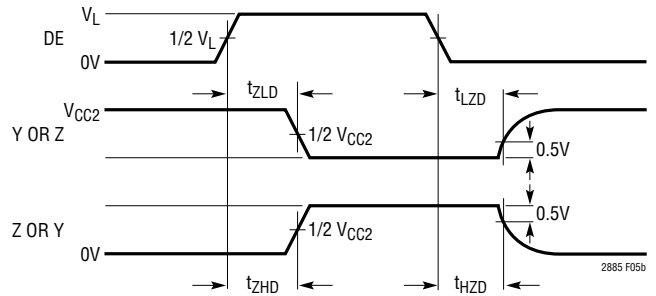
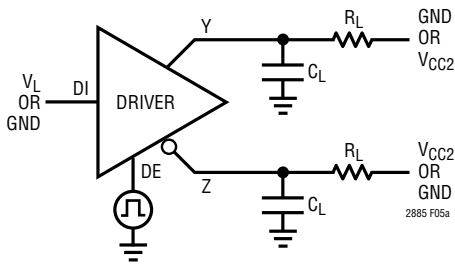

Figure 5. Driver Enable and Disable Timing Measurements

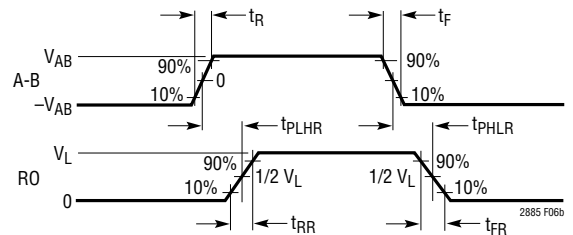
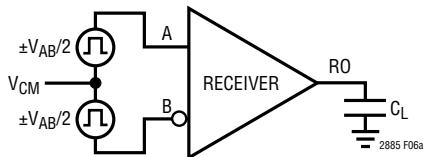

Figure 6. Propagation Delay Measurements

TEST CIRCUITS

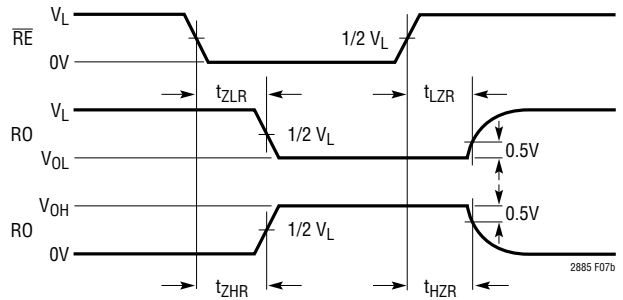
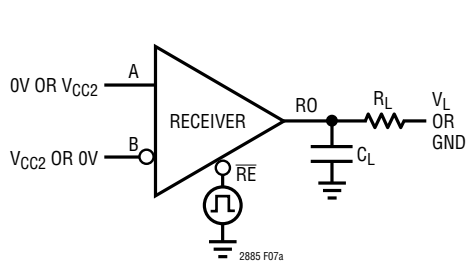

Figure 7. Receiver Enable/Disable Time Measurements

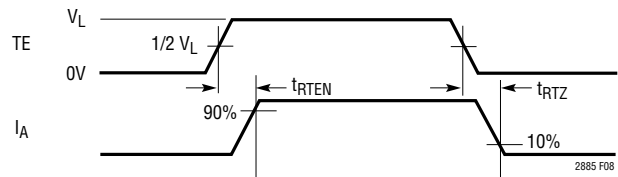
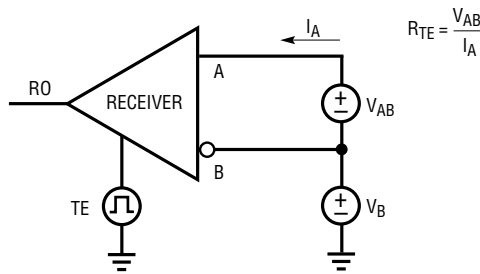

Figure 8. Termination Resistance and Timing Measurements

FUNCTIONAL TABLE

LOGIC INPUTS				MODE	A, B	Y, Z	RO	DC/DC CONVERTER	TERMINATOR
ON	RE	TE	DE						
1	0	0	0	Receive	R _{IN}	Hi-Z	Enabled	On	Off
1	0	0	1	Transceive		Driven			
1	0	1	0	Receive + Term On	R _{TE}	Hi-Z			On
1	0	1	1	Transceive + Term On		Driven			
1	1	0	0	Power On	R _{IN}	Hi-Z	Hi-Z	Off	
1	1	0	1	Transmit		Driven			
1	1	1	0	Term On	R _{TE}	Hi-Z			On
1	1	1	1	Transmit + Term On		Driven			
0	X	X	X	Off	R _{IN}	Hi-Z	Off	Off	

APPLICATIONS INFORMATION

Overview

The LTM2885 μ Module transceiver provides a galvanically-isolated robust RS485/RS422 interface, powered by an integrated, regulated DC/DC converter, complete with decoupling capacitors. A switchable termination resistor is integrated at the receiver input to provide proper termination to the RS485 bus. The LTM2885 is ideal for use in networks where grounds can take on different voltages. Isolation in the LTM2885 blocks high voltage differences and eliminates ground loops and is extremely tolerant of common mode transients between ground potentials. Error free operation is maintained through common mode events greater than 50kV/ μ s providing excellent noise isolation.

μ Module Technology

The LTM2885 utilizes isolator μ Module technology to translate signals and power across an isolation barrier. Signals on either side of the barrier are encoded into pulses and translated across the isolation boundary using coreless transformers formed in the μ Module substrate. This system, complete with data refresh, error checking, safe shutdown on fail, and extremely high common mode immunity, provides a robust solution for bidirectional signal isolation. The μ Module technology provides the means to combine the isolated signaling with our RS485 transceiver and powerful isolated DC/DC converter in one small package.

DC/DC Converter

The LTM2885 contains a fully integrated isolated DC/DC converter, including the transformer, so that no external components are necessary. The logic side contains a full-bridge driver, running about 2MHz, and is AC-coupled to a single transformer primary. A series DC blocking capacitor prevents transformer saturation due to driver duty cycle imbalance. The transformer scales the primary voltage, which is then rectified by a voltage doubler. This topology eliminates transformer saturation caused by secondary imbalances.

The DC/DC converter is connected to a low dropout regulator (LDO) to provide a regulated low noise 5V output.

The internal power solution is sufficient to support the transceiver interface at its maximum specified load and

data rate. The logic supplies, V_{CC} and V_L have a 2.2 μ F decoupling capacitance to GND and the isolated supply V_{CC2} has a 2.2 μ F decoupling capacitance to GND2 within the μ Module package.

V_{CC2} Output

The on-board DC/DC converter provides isolated 5V power to output V_{CC2} . V_{CC2} is capable of supplying up to 1W of power at 5V. This surplus current is available to external applications. The amount of surplus current is dependent upon the implementation and current delivered to the RS485 driver and line load. An example of available surplus current is shown in the Typical Performance Characteristics graph, V_{CC2} Surplus Current vs Temperature. Figure 21 demonstrates a method of using the V_{CC2} output directly and with a switched power path that is controlled with the isolated RS485 data channel.

Driver

The driver provides full RS485 and RS422 compatibility. When enabled, if DI is high, Y–Z is positive. When the driver is disabled, both outputs are high impedance with less than 10 μ A of leakage current over the entire common mode range of –7V to 12V, with respect to GND2.

Driver Overvoltage and Overcurrent Protection

The driver outputs are protected from short circuits to any voltage within the absolute maximum range of (V_{CC2} –15V) to (GND2 +15V) levels. The maximum V_{CC2} current in this condition is 250mA. If the pin voltage exceeds about \pm 10V, current limit folds back to about half of the peak value to reduce overall power dissipation and avoid damaging the part.

The device also features thermal shutdown protection that disables the driver and receiver output in case of excessive power dissipation (see Note 4 in the Electrical Characteristics section).

\overline{SLO} Mode

The LTM2885 features a logic-selectable reduced slew rate mode (\overline{SLO} mode) that softens the driver output edges to reduce EMI emissions from equipment and data cables. The reduced slew rate mode is entered by

APPLICATIONS INFORMATION

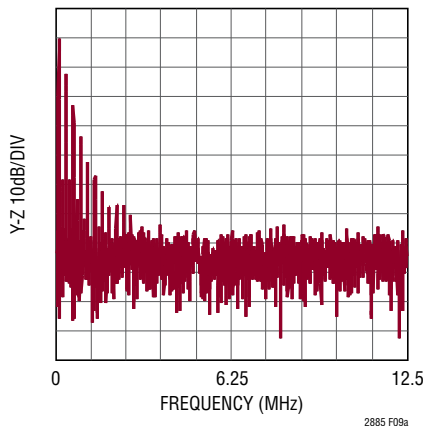
Figure 9a. Frequency Spectrum $\overline{\text{SLO}}$ Mode 125kHz Input

taking the $\overline{\text{SLO}}$ pin low to GND2, where the data rate is limited to about 250kbps. Slew limiting also mitigates the adverse effects of imperfect transmission line termination caused by stubs or mismatched cables.

Figures 9a and 9b show the frequency spectrums of the LTM2885 driver outputs in normal and $\overline{\text{SLO}}$ mode operating at 250kbps. $\overline{\text{SLO}}$ mode significantly reduces the high frequency harmonics.

Receiver and Failsafe

With the receiver enabled, when the absolute value of the differential voltage between the A and B pins is greater than 200mV, the state of RO will reflect the polarity of (A-B). During data communication the receiver detects the state of the input with symmetric thresholds around 0V. The symmetric thresholds preserve duty cycle for attenuated signals with slow transition rates on high capacitive busses, or long cable lengths. The receiver incorporates a failsafe feature that guarantees the receiver output to be a logic-high during an idle bus, when the inputs are shorted, left open or terminated, but not driven for more than approximately 3 μ s. The failsafe feature eliminates the need for system level integration of network pre-biasing by guaranteeing a logic-high on RO under the conditions of an idle bus. Further network biasing constructed to condition transient noise during an idle state is unnecessary due to the common mode transient rejection of the LTM2885. The failsafe detector monitors A and B in parallel with the receiver and detects the state of the bus when A-B is above

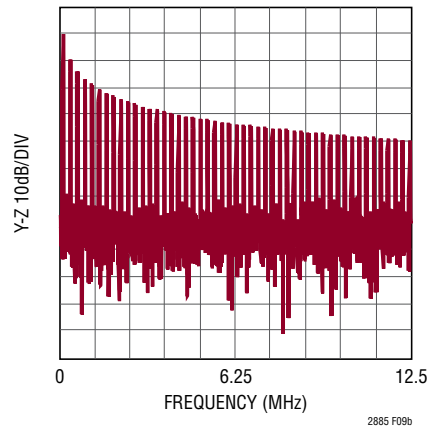

Figure 9b. Normal Mode Frequency Spectrum 125kHz Input

the input failsafe threshold for longer than about 3 μ s with a hysteresis of 25mV. This failsafe feature is guaranteed to work for inputs spanning the entire common mode range of -7V to 12V.

The receiver output is internally driven high (to V_L) or low (to GND) with no external pull-up needed. When the receiver is disabled the RO pin becomes Hi-Z with leakage of less than $\pm 1\mu$ A for voltages within the supply range.

Receiver Input Resistance

The receiver input resistance from A or B to GND2 is greater than 96k permitting up to a total of 256 receivers per system without exceeding the RS485 receiver loading specification. High temperature H-grade operation reduces the input resistance to 48k permitting 128 receivers on the bus. The input resistance of the receiver is unaffected by enabling/disabling the receiver or by powering/unpowering the part. The equivalent input resistance looking into A and B is shown in Figure 10.

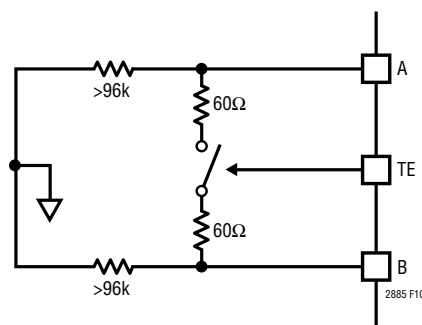

Figure 10. Equivalent Input Resistance into A and B

APPLICATIONS INFORMATION

Switchable Termination

Proper cable termination is very important for signal fidelity. If the cable is not terminated with its characteristic impedance, reflections will distort the signal waveforms.

The integrated switchable termination resistor provides logic control of the line termination for optimal performance when configuring transceiver networks.

When the TE pin is high, the termination resistor is enabled and the differential resistance from A to B is 120Ω . Figure 11 shows the I/V characteristics between pins A and B with the termination resistor enabled and disabled. The resistance is maintained over the entire RS485 common mode range of $-7V$ to $12V$ as shown in Figure 12. The integrated termination resistor has a high frequency response which does not limit performance at the maximum specified data rate. Figure 13 shows the magnitude

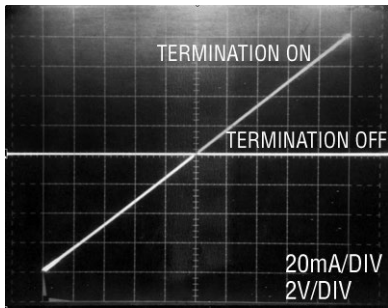

Figure 11. Curve Trace Between A and B with Termination Enabled and Disabled

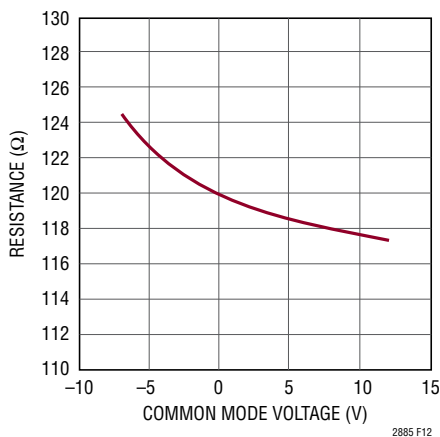

Figure 12. Termination Resistance vs Common Mode Voltage

and phase of the termination impedance versus frequency. The termination resistor cannot be enabled by TE if the device is unpowered, ON is low or the LTM2885 is in thermal shutdown.

Supply Current

The static supply current is dominated by power delivered to the termination resistance. Power supply current increases with data rate due to capacitive loading. Figure 14 shows supply current versus data rate for three different loads for the circuit configuration of Figure 4. Supply current increases with additional external applications drawing current from V_{CC2} .

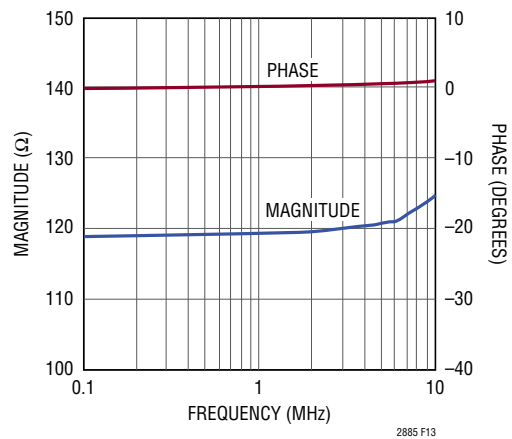

Figure 13. Termination Magnitude and Phase vs Frequency

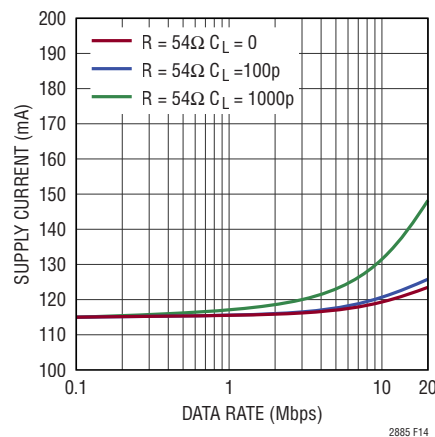

Figure 14. Supply Current vs Data Rate

APPLICATIONS INFORMATION

PROFIBUS Applications

The LTM2885 can be used in PROFIBUS-DP networks where isolation is required. The standard PROFIBUS termination differs from RS485 termination and is shown in Figure 15. If used in this way, the internal termination should remain disabled (TE low). The 390Ω resistors in Figure 15 pre-bias the bus so that when the line is not driven, the receiver's output is high.

V_{CC2} , provides an isolated source for the external termination resistor as shown in the Figure 15. When using the LTM2885 in PROFIBUS applications, it is recommended that no additional loads are connected to V_{CC2} in order to maintain the specified driver output swing.

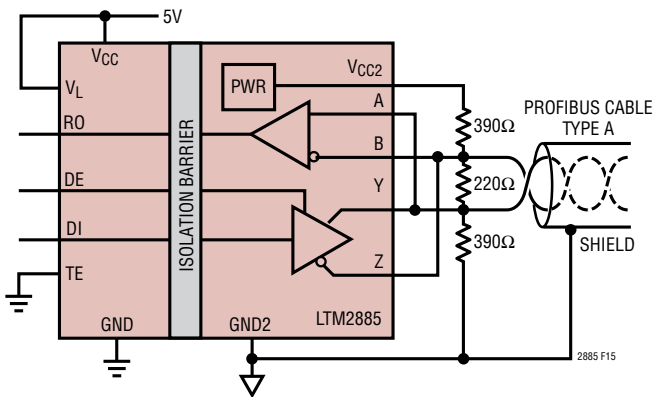

Figure 15. PROFIBUS-DP Connections with Termination

PCB Layout

The high integration of the LTM2885 makes PCB layout very simple. However, to optimize its electrical isolation characteristics, EMI, and thermal performance, some layout considerations are necessary.

- Under heavily loaded conditions V_{CC} and GND current can exceed 300mA. Sufficient copper must be used on the PCB to insure resistive losses do not cause the supply voltage to drop below the minimum allowed level. Similarly, the V_{CC2} and GND2 conductors must be sized to support any external load current. These heavy copper traces will also help to reduce thermal stress and improve the thermal conductivity.

- Input and output decoupling is not required, since these components are integrated within the package. An additional bulk capacitor with a value of 6.8μF to 22μF is recommended. The high ESR of this capacitor reduces board resonances and minimizes voltage spikes caused by hot plugging of the supply voltage. For EMI sensitive applications, an additional low ESL ceramic capacitor of 1μF to 4.7μF, placed as close to the power and ground terminals as possible, is recommended. Alternatively, a number of smaller value parallel capacitors may be used to reduce ESL and achieve the same net capacitance.
- Do not place copper on the PCB between the inner columns of pads. This area must remain open to withstand the rated isolation voltage.
- The use of solid ground planes for GND and GND2 is recommended for non-EMI critical applications to optimize signal fidelity, thermal performance, and to minimize RF emissions due to uncoupled PCB trace conduction. The drawback of using ground planes, where EMI is of concern, is the creation of a dipole antenna structure which can radiate differential voltages formed between GND and GND2. If ground planes are used it is recommended to minimize their area, and use contiguous planes as any openings or splits can exacerbate RF emissions.
- For large ground planes a small capacitance (≤ 330 pF) from GND to GND2, either discrete or embedded within the substrate, provides a low impedance current return path for the module parasitic capacitance, minimizing any high frequency differential voltages and substantially reducing radiated emissions. Discrete capacitance will not be as effective due to parasitic ESL. In addition, voltage rating, leakage, and clearance must be considered for component selection. Embedding the capacitance within the PCB substrate provides a near ideal capacitor and eliminates component selection issues; however, the PCB must be 4 layers. Care must be exercised in applying either technique to insure the voltage rating of the barrier is not compromised.

APPLICATIONS INFORMATION

The PCB layout in Figures 16a and 16b shows the demo board for the LTM2885. The demo board includes provisions for adding two series discrete capacitors across the

isolation boundary (C3 and C4). Safety rated Class X1 or Y1 capacitors are recommended, Vishay's VY1 or WKP series are appropriate.

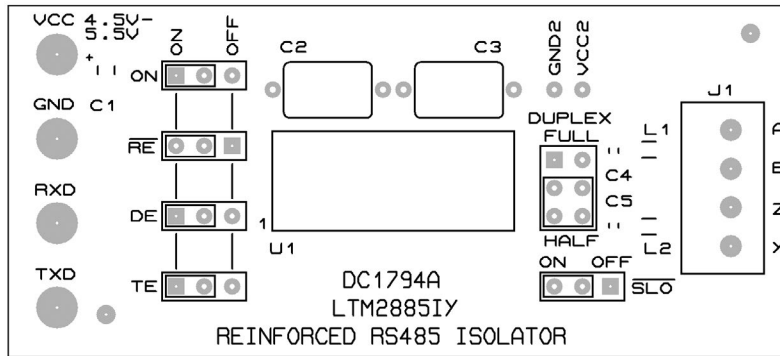

Figure 16a. LTM2885 Demo Board Layout

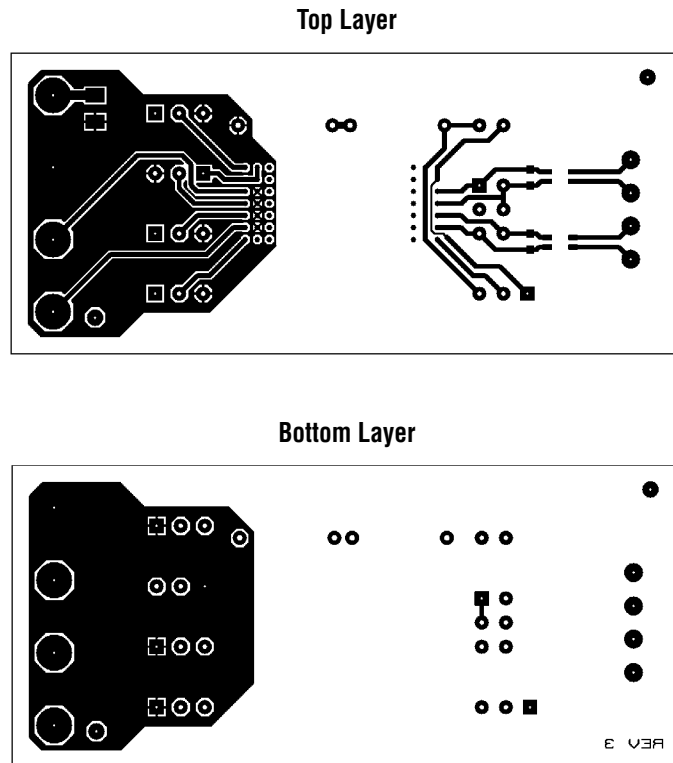

Figure 16b. LTM2885 Demo Board Layout (DC1794A)

APPLICATIONS INFORMATION

EMI performance is shown in Figure 17, measured using a Gigahertz Transverse Electromagnetic (GTEM) cell and method detailed in IEC 61000-4-20, “Testing and Measurement Techniques—Emission and Immunity Testing in Transverse Electromagnetic Waveguides”.

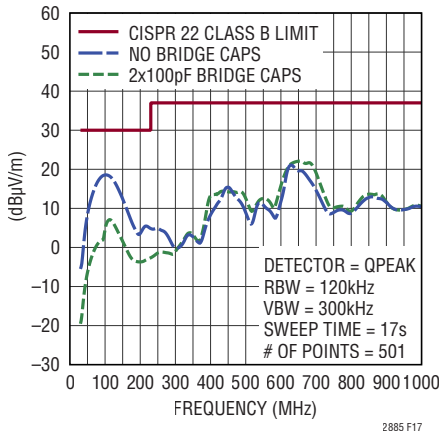

Figure 17. LTM2885 Demo Circuit 1794A Emissions

Cable Length versus Data Rate

For a given data rate, the maximum transmission distance is bounded by the cable properties. A typical curve of cable length versus data rate compliant with the RS485 standard is shown in Figure 18. Three regions of this curve reflect different performance limiting factors in data transmission. In the flat region of the curve, maximum distance is determined by resistive loss in the cable. The downward sloping region represents limits in distance and rate due to the AC losses in the cable. The solid vertical line represents the specified maximum data rate in the RS485 standard. The dashed line at 250kbps shows the maximum data rate when \overline{SLO} is low. The dashed line at 20Mbps shows the maximum data rate when \overline{SLO} is high.

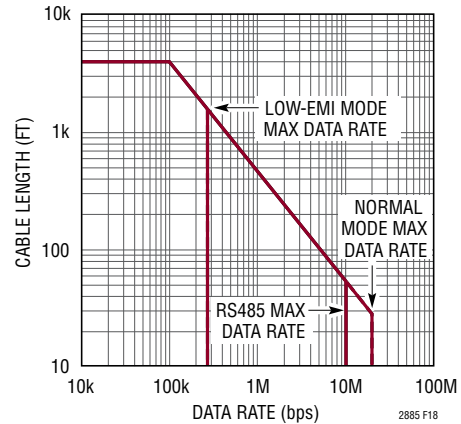

Figure 18. Cable Length vs Data Rate

RF, Magnetic Field Immunity

The LTM2885 has been independently evaluated and has successfully passed the RF and magnetic field immunity testing requirements per European Standard EN 55024, in accordance with the following test standards:

- EN 61000-4-3 Radiated, Radio-Frequency, Electromagnetic Field Immunity
- EN 61000-4-8 Power Frequency Magnetic Field Immunity
- EN 61000-4-9 Pulsed Magnetic Field Immunity

Tests were performed using an unshielded test card designed per the data sheet PCB layout recommendations. Specific limits per test are detailed in Table 1.

Table 1.

TEST	FREQUENCY	FIELD STRENGTH
EN 61000-4-3, Annex D	80MHz to 1GHz	10V/m
	1.4MHz to 2GHz	3V/m
	2GHz to 2.7GHz	1V/m
EN61000-4-8, Level 4	50Hz and 60Hz	30A/m
EN61000-4-8, Level 5	60Hz	100A/m*
EN61000-4-9, Level 5	Pulse	1000A/m

*Non IEC Method

PACKAGE DESCRIPTION

BGA Package 42-Lead (22mm × 9mm × 5.16mm) (Reference LTC DWG# 05-08-1960 Rev A)

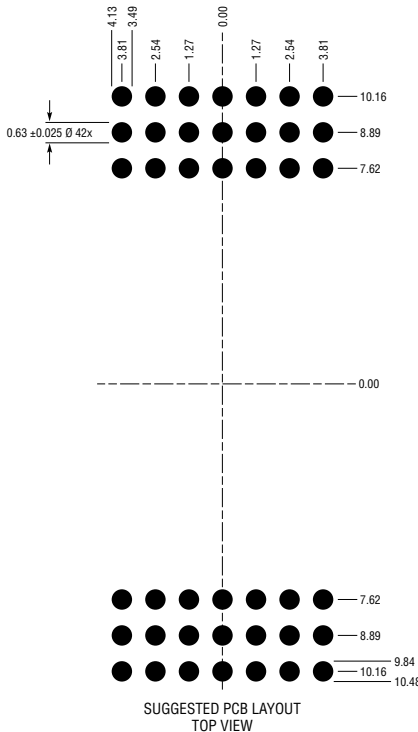
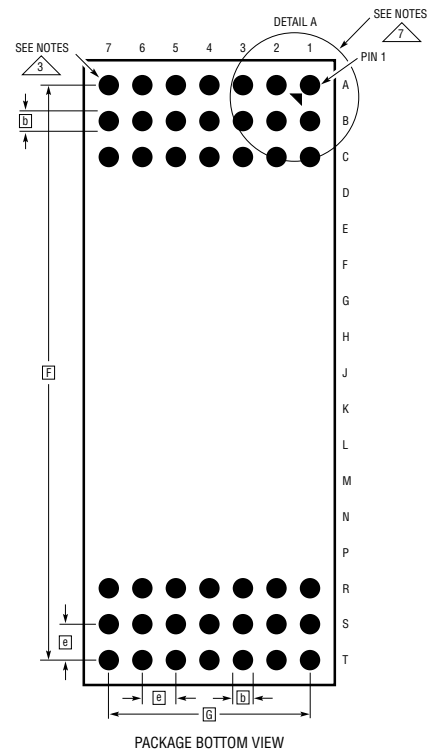
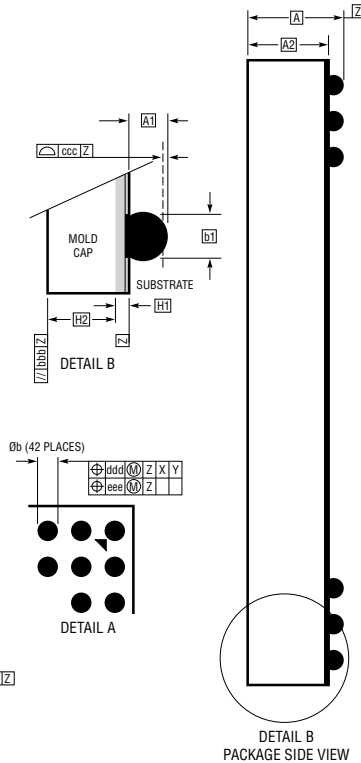
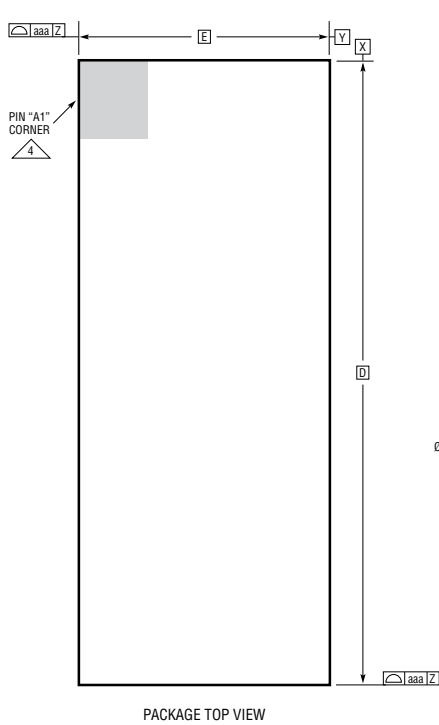

DIMENSIONS				
SYMBOL	MIN	NOM	MAX	NOTES
A	4.91	5.16	5.41	
A1	0.50	0.60	0.70	
A2	4.41	4.56	4.71	
b	0.60	0.75	0.90	
b1	0.60	0.63	0.66	
D		22.0		
E		9.0		
e		1.27		
F		20.32		
G		7.62		
H1	0.46	0.56	0.66	
H2	3.95	4.00	4.05	
aaa			0.15	
bbb			0.10	
ccc			0.15	
ddd			0.15	
eee			0.08	

TOTAL NUMBER OF BALLS: 42

- NOTES:
1. DIMENSIONING AND TOLERANCING PER ASME Y14.5M-1994
 2. ALL DIMENSIONS ARE IN MILLIMETERS
 - 3 BALL DESIGNATION PER JESD MS-028 AND JEP95
 - 4 DETAILS OF PIN #1 IDENTIFIER ARE OPTIONAL, BUT MUST BE LOCATED WITHIN THE ZONE INDICATED. THE PIN #1 IDENTIFIER MAY BE EITHER A MOLD OR MARKED FEATURE
 5. PRIMARY DATUM -Z- IS SEATING PLANE
 6. SOLDER BALL COMPOSITION IS 96.5% Sn/3.0% Ag/0.5% Cu
 - 7 PACKAGE ROW AND COLUMN LABELING MAY VARY AMONG μ Module PRODUCTS. REVIEW EACH PACKAGE LAYOUT CAREFULLY

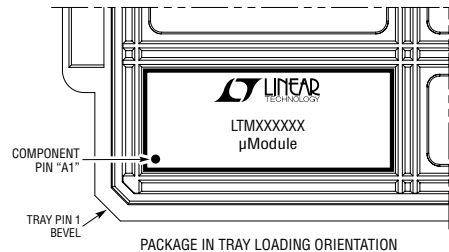

BGA 42 0314 REV A

REVISION HISTORY

REV	DATE	DESCRIPTION	PAGE NUMBER
A	04/17	Added Receiver Output Disable Time.	5
B	03/22	Added CSA (UL/IEC) Certifications.	1, 6

TYPICAL APPLICATION

Multi-Node Network with End Termination and Single Ground Connection on Isolation Bus

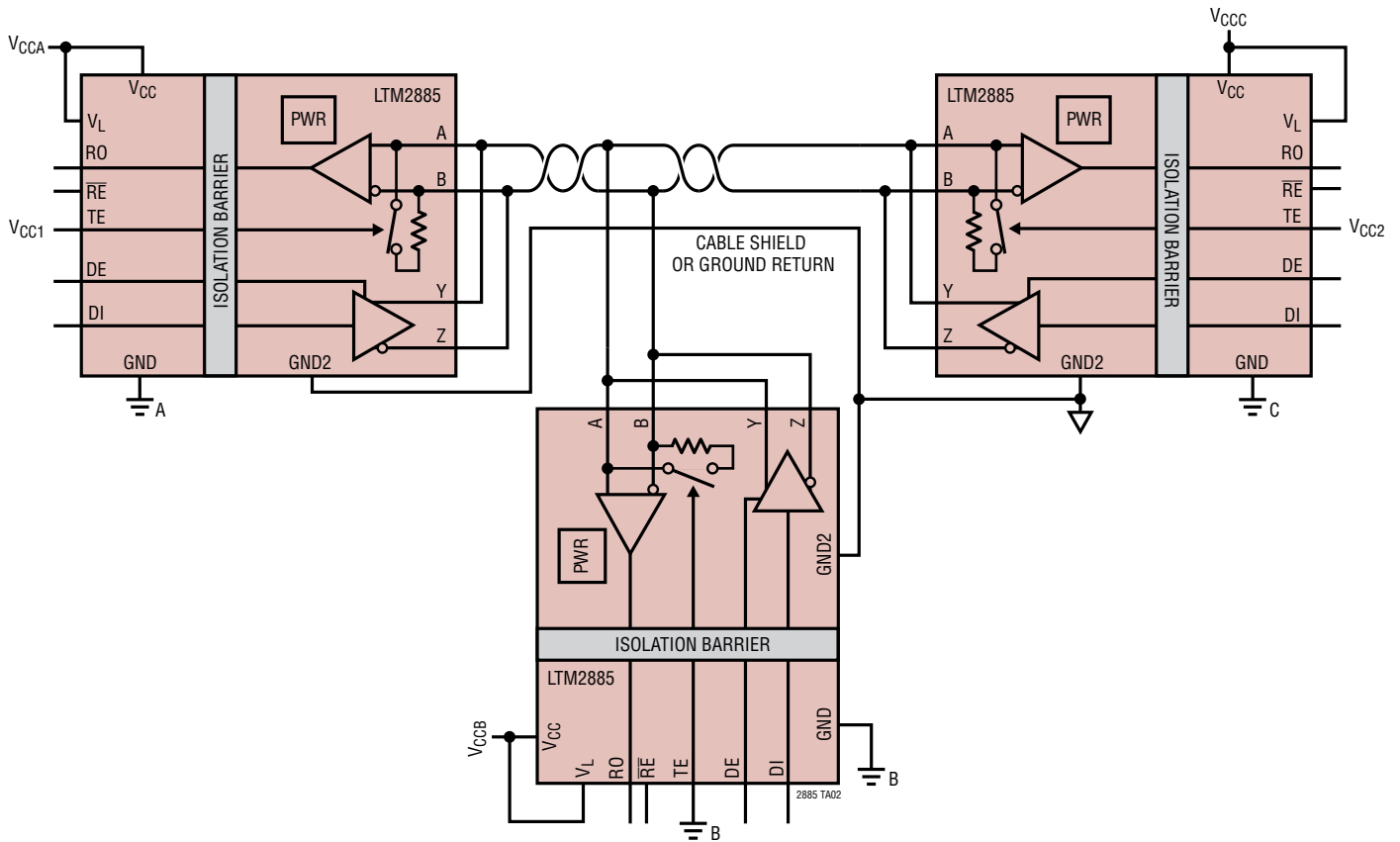

RELATED PARTS

PART NUMBER	DESCRIPTION	COMMENTS
LTM2881	Isolated RS485/RS422 μ Module Transceiver with Power	20Mbps, $\pm 15\text{kV}$ ESD, $2500\text{V}_{\text{RMS}}$ Isolation with Power
LTM2882	Dual Isolated RS232 μ Module Transceiver with Power	1Mbps, $\pm 10\text{kV}$ ESD, $2500\text{V}_{\text{RMS}}$ Isolation with Power
LTM2883	SPI/Digital or I ² C μ Module Isolator with Power	$2500\text{V}_{\text{RMS}}$ Isolation with Adjustable $\pm 12.5\text{V}$ and 5V Power in BGA Package
LTM2884	Isolated USB Transceiver with Power	$2500\text{V}_{\text{RMS}}$, Auto Speed Selection, 1W to 2.5W Isolated Power
LTM2886	SPI or I ² C μ Module Isolator with Adjustable 5V and $\pm 5\text{V}$ Regulated Power	$2500\text{V}_{\text{RMS}}$ Isolation in Surface Mount BGA
LTM2889	Complete 4Mbps CAN FD μ Module Isolator + Power	$2500\text{V}_{\text{RMS}}$ Isolation in Surface Mount BGA
LTM2892	SPI/Digital or I ² C Isolated μ Module	$3500\text{V}_{\text{RMS}}$ Isolation without Power in $9\text{mm} \times 6.25\text{mm}$ BGA Package
LTM2893	Complete 100MHz SPI ADC μ Module Isolator	$6000\text{V}_{\text{RMS}}$ Isolation in Surface Mount BGA
LTM2894	Complete Isolated USB μ Module Transceiver	$7500\text{V}_{\text{RMS}}$ Isolation in Surface Mount BGA
LTC[®]1535	Isolated RS485 Transceiver	$2500\text{V}_{\text{RMS}}$ Isolation in Surface Mount Package
LT[®]1785	$\pm 60\text{V}$ Fault-Protected Transceiver	Half Duplex
LT1791	$\pm 60\text{V}$ Fault-Protected Transceiver	Full Duplex
LTC2861	20Mbps RS485 Transceiver with Integrated Switchable Termination	Full Duplex, 15kV ESD
LTC2862-5	20Mbps RS485 Transceiver, $\pm 60\text{V}$ Fault Protected	$\pm 25\text{V}$ Common Mode Range, 15kV ESD