

1.5MHz, 600mA
 Synchronous Step-Down
 Regulator in ThinSOT

FEATURES

- High Efficiency: Up to 96%
- Very Low Quiescent Current: Only 20 μ A During Operation
- 600mA Output Current
- 2.5V to 5.5V Input Voltage Range
- 1.5MHz Constant Frequency Operation
- No Schottky Diode Required
- Low Dropout Operation: 100% Duty Cycle
- 0.6V Reference Allows Low Output Voltages
- Shutdown Mode Draws $\leq 1\mu$ A Supply Current
- Current Mode Operation for Excellent Line and Load Transient Response
- Overtemperature Protected
- Low Profile (1mm) ThinSOTTM Package

APPLICATIONS

- Cellular Telephones
- Personal Information Appliances
- Wireless and DSL Modems
- Digital Still Cameras
- MP3 Players
- Portable Instruments

DESCRIPTION

The LTC[®]3406 is a high efficiency monolithic synchronous buck regulator using a constant frequency, current mode architecture. The device is available in an adjustable version and fixed output voltages of 1.5V and 1.8V. Supply current during operation is only 20 μ A and drops to $\leq 1\mu$ A in shutdown. The 2.5V to 5.5V input voltage range makes the LTC3406 ideally suited for single Li-Ion battery-powered applications. 100% duty cycle provides low dropout operation, extending battery life in portable systems. Automatic Burst Mode[®] operation increases efficiency at light loads, further extending battery life.

Switching frequency is internally set at 1.5MHz, allowing the use of small surface mount inductors and capacitors.

The internal synchronous switch increases efficiency and eliminates the need for an external Schottky diode. Low output voltages are easily supported with the 0.6V feedback reference voltage. The LTC3406 is available in a low profile (1mm) ThinSOT package.

LT, LTC and LT are registered trademarks of Linear Technology Corporation. Burst Mode is a registered trademark of Linear Technology Corporation. ThinSOT is a trademark of Linear Technology Corporation. Protected by U.S. Patents, including 6580258, 5481178.

TYPICAL APPLICATION

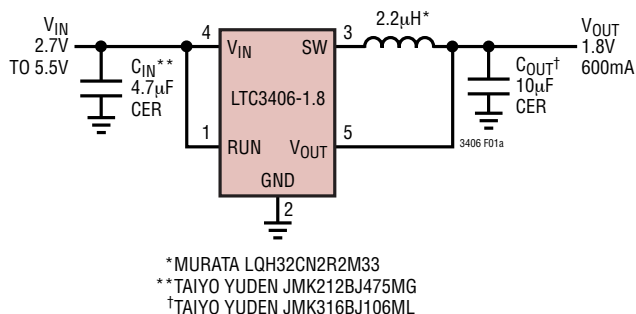

Figure 1a. High Efficiency Step-Down Converter

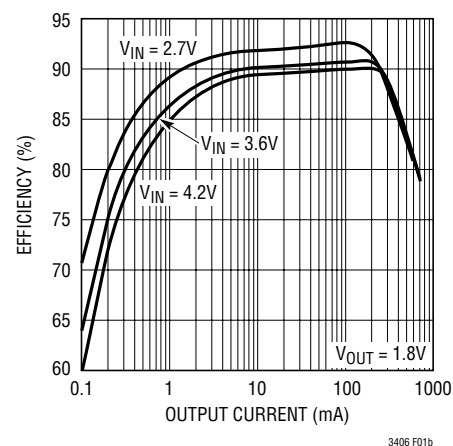

Figure 1b. Efficiency vs Load Current

LTC3406

LTC3406-1.5/LTC3406-1.8

ABSOLUTE MAXIMUM RATINGS (Note 1)

Input Supply Voltage	-0.3V to 6V	Peak SW Sink and Source Current	1.3A
RUN, V _{FB} Voltages	-0.3V to V _{IN}	Operating Temperature Range (Note 2) ..	-40°C to 85°C
SW Voltage	-0.3V to (V _{IN} + 0.3V)	Junction Temperature (Note 3)	125°C
P-Channel Switch Source Current (DC)	800mA	Storage Temperature Range	-65°C to 150°C
N-Channel Switch Sink Current (DC)	800mA	Lead Temperature (Soldering, 10 sec)	300°C

PACKAGE/ORDER INFORMATION

	ORDER PART NUMBER		ORDER PART NUMBER
	LTC3406ES5		LTC3406ES5-1.5 LTC3406ES5-1.8
	S5 PART MARKING		S5 PART MARKING
	LTA5		LTD6 LTC4

Consult LTC Marketing for parts specified with wider operating temperature ranges.

ELECTRICAL CHARACTERISTICS

The ● denotes specifications which apply over the full operating temperature range, otherwise specifications are T_A = 25°C. V_{IN} = 3.6V unless otherwise specified.

SYMBOL	PARAMETER	CONDITIONS	MIN	TYP	MAX	UNITS
I _{VFB}	Feedback Current		●		±30	nA
V _{FB}	Regulated Feedback Voltage	LTC3406 (Note 4) T _A = 25°C LTC3406 (Note 4) 0°C ≤ T _A ≤ 85°C LTC3406 (Note 4) -40°C ≤ T _A ≤ 85°C	●	0.5880 0.5865 0.5850	0.6 0.6 0.6	0.6120 0.6135 0.6150 V
ΔV _{FB}	Reference Voltage Line Regulation	V _{IN} = 2.5V to 5.5V (Note 4)	●	0.04	0.4	%/V
V _{OUT}	Regulated Output Voltage	LTC3406-1.5, I _{OUT} = 100mA LTC3406-1.8, I _{OUT} = 100mA	●	1.455 1.746	1.500 1.800	1.545 1.854 V
ΔV _{OUT}	Output Voltage Line Regulation	V _{IN} = 2.5V to 5.5V	●	0.04	0.4	%/V
I _{PK}	Peak Inductor Current	V _{IN} = 3V, V _{FB} = 0.5V or V _{OUT} = 90%, Duty Cycle < 35%		0.75	1	1.25 A
V _{LOADREG}	Output Voltage Load Regulation			0.5		%
V _{IN}	Input Voltage Range		●	2.5	5.5	V
I _S	Input DC Bias Current	(Note 5) Active Mode V _{FB} = 0.5V or V _{OUT} = 90%, I _{LOAD} = 0A Sleep Mode V _{FB} = 0.62V or V _{OUT} = 103%, I _{LOAD} = 0A Shutdown V _{RUN} = 0V, V _{IN} = 4.2V			300 20 0.1	400 35 1 μA
f _{OSC}	Oscillator Frequency	V _{FB} = 0.6V or V _{OUT} = 100% V _{FB} = 0V or V _{OUT} = 0V	●	1.2	1.5 210	1.8 kHz
R _{PFET}	R _{DS(ON)} of P-Channel FET	I _{SW} = 100mA		0.4	0.5	Ω
R _{NFET}	R _{DS(ON)} of N-Channel FET	I _{SW} = -100mA		0.35	0.45	Ω
I _{LSW}	SW Leakage	V _{RUN} = 0V, V _{SW} = 0V or 5V, V _{IN} = 5V		±0.01	±1	μA

3406fa

ELECTRICAL CHARACTERISTICS

The ● denotes specifications which apply over the full operating temperature range, otherwise specifications are $T_A = 25^\circ\text{C}$. $V_{IN} = 3.6\text{V}$ unless otherwise specified.

SYMBOL	PARAMETER	CONDITIONS	MIN	TYP	MAX	UNITS
V_{RUN}	RUN Threshold	●	0.3	1	1.5	V
I_{RUN}	RUN Leakage Current	●		± 0.01	± 1	μA

Note 1: Absolute Maximum Ratings are those values beyond which the life of a device may be impaired.

Note 2: The LTC3406E is guaranteed to meet performance specifications from 0°C to 70°C . Specifications over the -40°C to 85°C operating temperature range are assured by design, characterization and correlation with statistical process controls.

Note 3: T_J is calculated from the ambient temperature T_A and power dissipation P_D according to the following formula:

$$\text{LTC3406: } T_J = T_A + (P_D)(250^\circ\text{C/W})$$

Note 4: The LTC3406 is tested in a proprietary test mode that connects V_{FB} to the output of the error amplifier.

Note 5: Dynamic supply current is higher due to the gate charge being delivered at the switching frequency.

TYPICAL PERFORMANCE CHARACTERISTICS

(From Figure1a Except for the Resistive Divider Resistor Values)

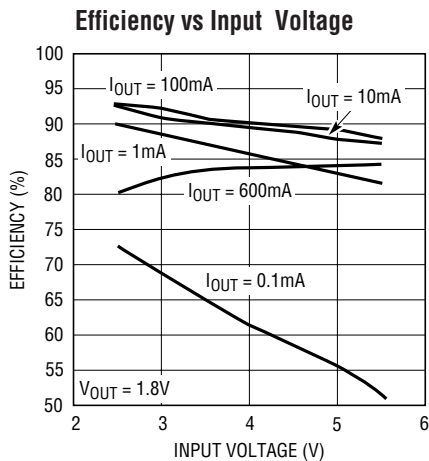

3406 G01

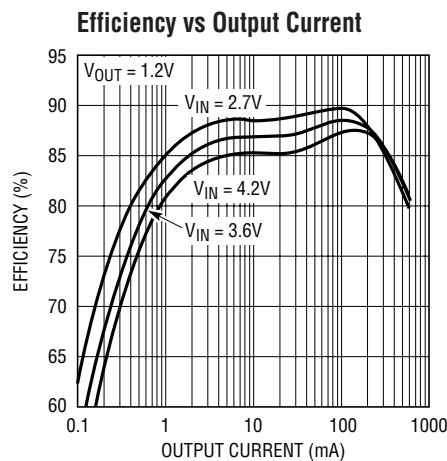

3406 G02

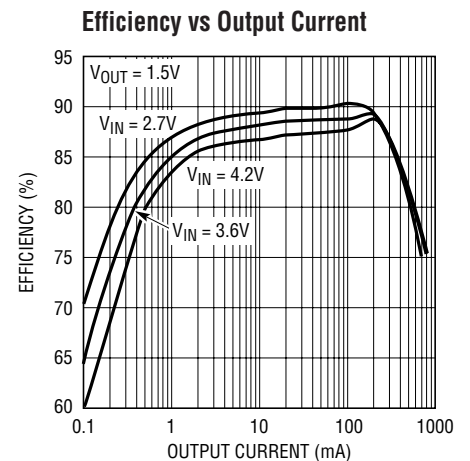

3406 G03

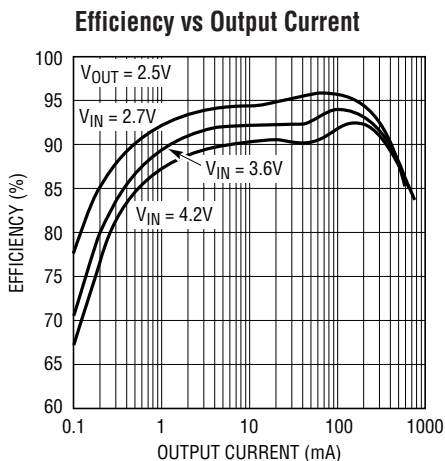

3406 G04

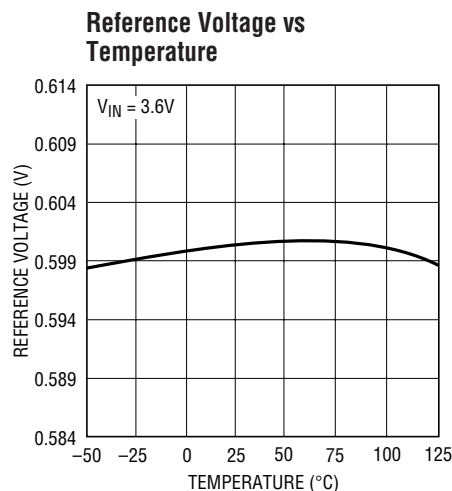

3406 G05

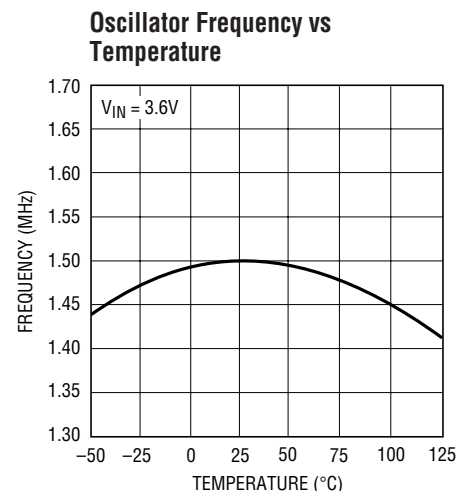

3406 G06

TYPICAL PERFORMANCE CHARACTERISTICS

(From Figure 1a Except for the Resistive Divider Resistor Values)

Oscillator Frequency vs Supply Voltage

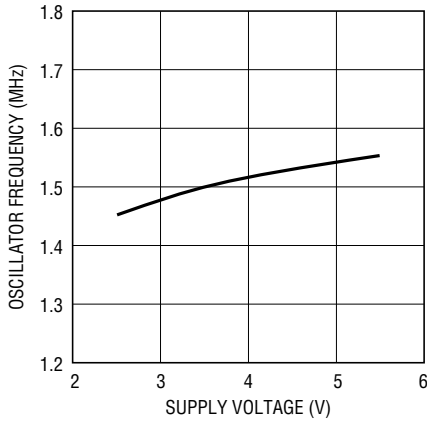

3406 G07

Output Voltage vs Load Current

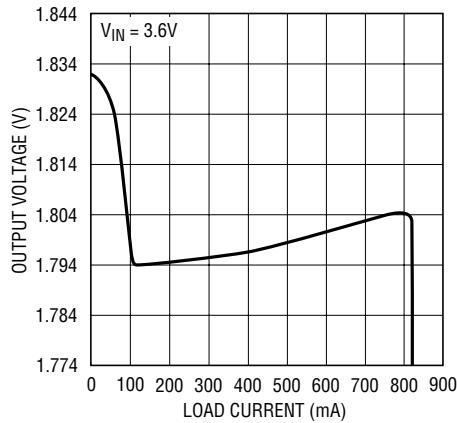

3406 G08

$R_{DS(ON)}$ vs Input Voltage

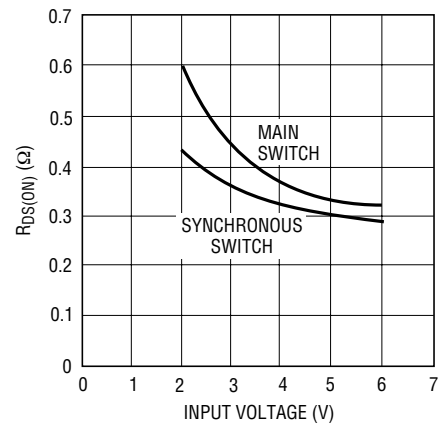

3406 G09

$R_{DS(ON)}$ vs Temperature

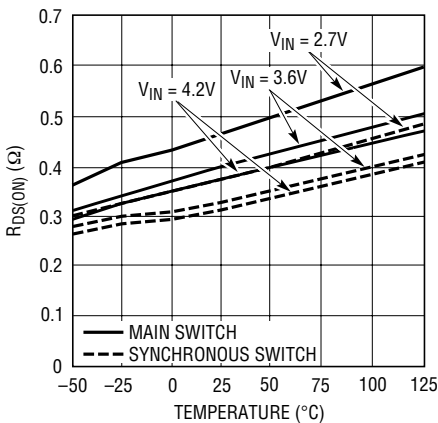

3406 G10

Supply Current vs Supply Voltage

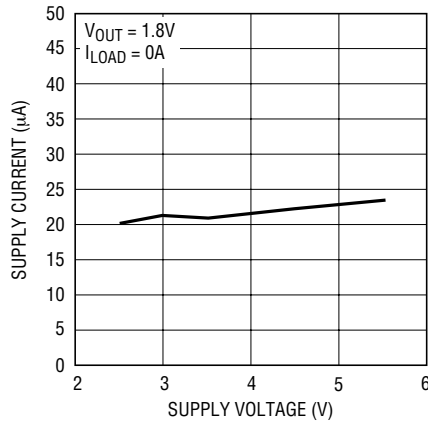

3406 G11

Supply Current vs Temperature

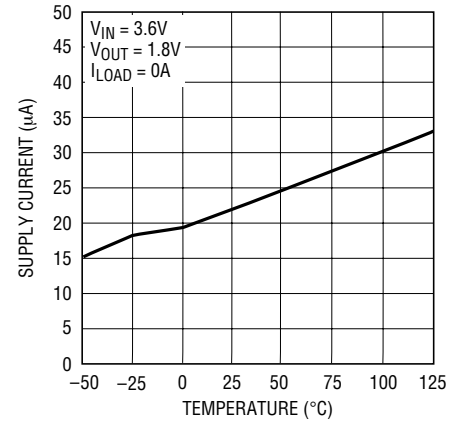

3406 G12

Switch Leakage vs Temperature

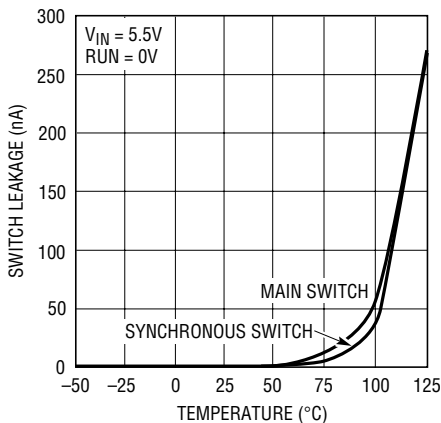

3406 G13

Switch Leakage vs Input Voltage

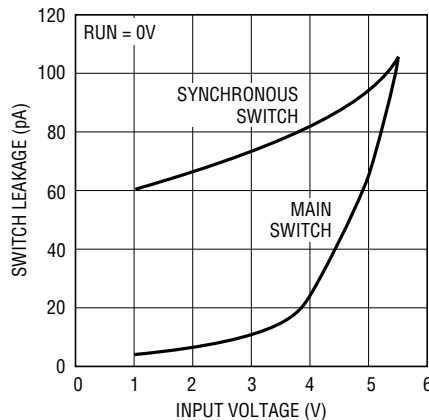

3406 G14

Burst Mode Operation

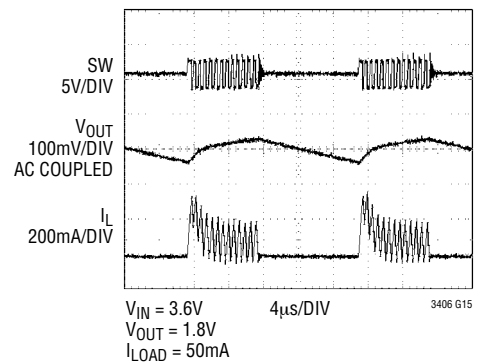

3406 G15

TYPICAL PERFORMANCE CHARACTERISTICS

(From Figure 1a Except for the Resistive Divider Resistor Values)

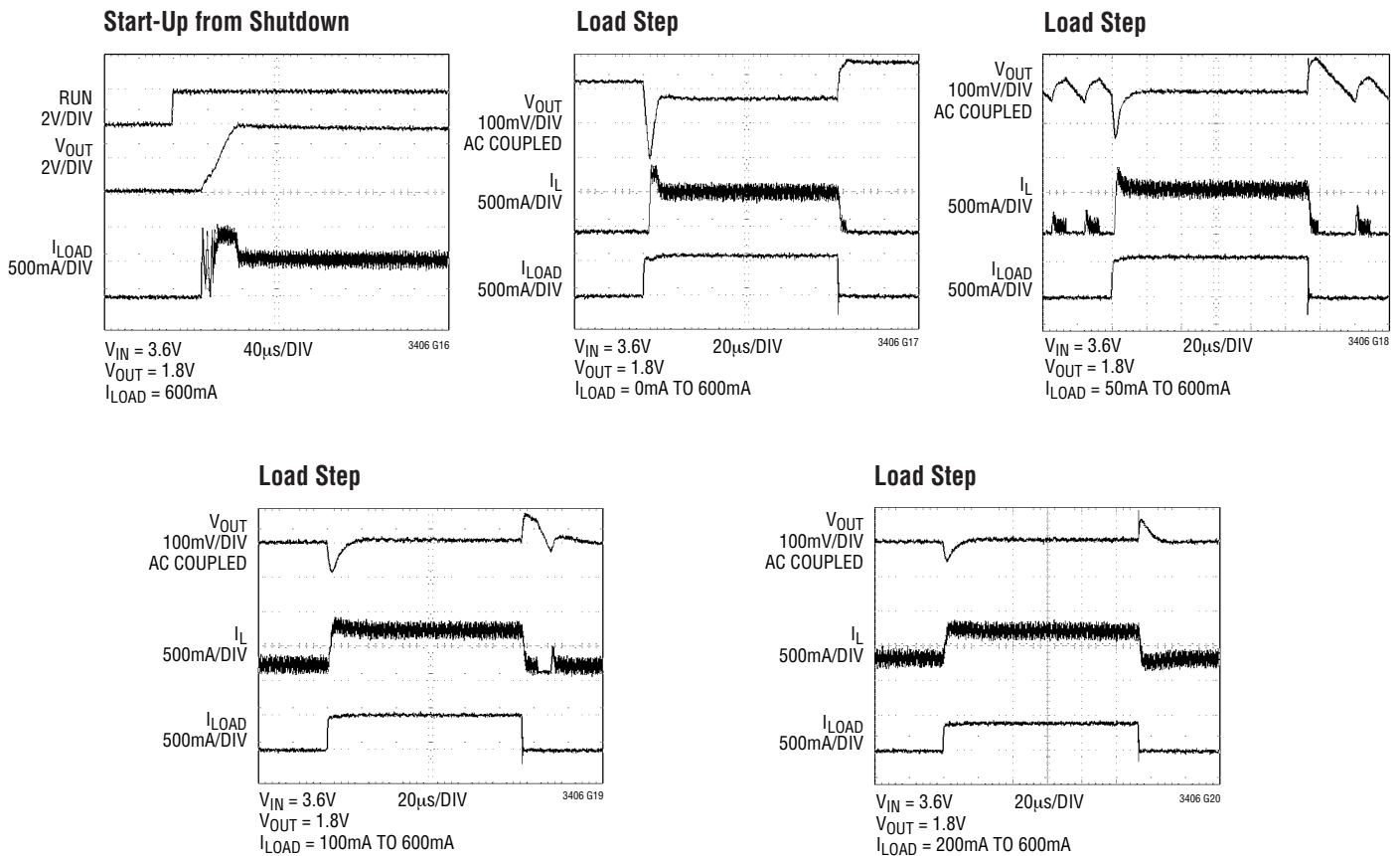

PIN FUNCTIONS

RUN (Pin 1): Run Control Input. Forcing this pin above 1.5V enables the part. Forcing this pin below 0.3V shuts down the device. In shutdown, all functions are disabled drawing $<1\mu A$ supply current. Do not leave RUN floating.

GND (Pin 2): Ground Pin.

SW (Pin 3): Switch Node Connection to Inductor. This pin connects to the drains of the internal main and synchronous power MOSFET switches.

V_{IN} (Pin 4): Main Supply Pin. Must be closely decoupled to GND, Pin 2, with a 2.2 μF or greater ceramic capacitor.

V_{FB} (Pin 5) (LTC3406): Feedback Pin. Receives the feedback voltage from an external resistive divider across the output.

V_{OUT} (Pin 5) (LTC3406-1.5/LTC3406-1.8): Output Voltage Feedback Pin. An internal resistive divider divides the output voltage down for comparison to the internal reference voltage.

FUNCTIONAL DIAGRAM

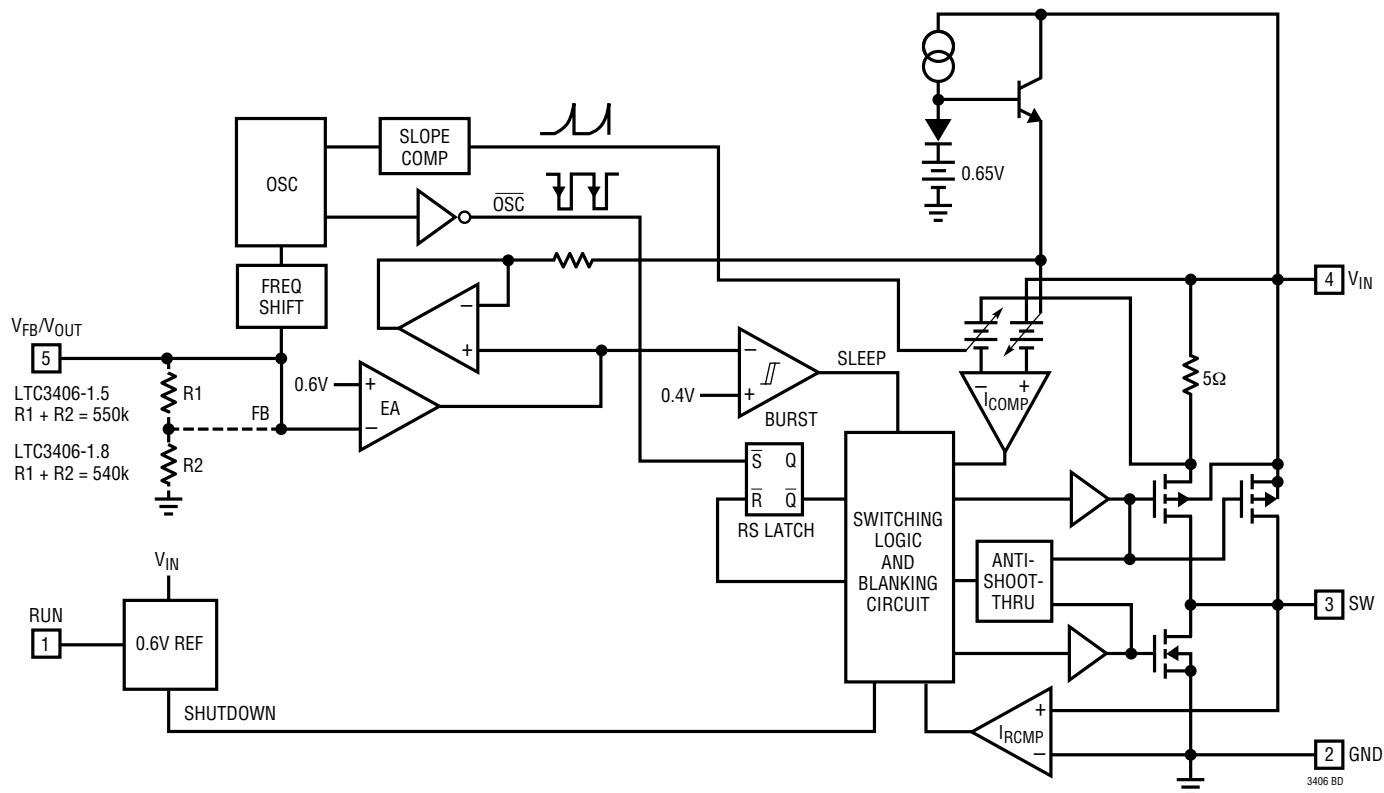

OPERATION (Refer to Functional Diagram)

Main Control Loop

The LTC3406 uses a constant frequency, current mode step-down architecture. Both the main (P-channel MOSFET) and synchronous (N-channel MOSFET) switches are internal. During normal operation, the internal top power MOSFET is turned on each cycle when the oscillator sets the RS latch, and turned off when the current comparator, I_{COMP} , resets the RS latch. The peak inductor current at which I_{COMP} resets the RS latch, is controlled by the output of error amplifier EA. When the load current increases, it causes a slight decrease in the feedback voltage, FB, relative to the 0.6V reference, which in turn, causes the EA amplifier's output voltage to increase until the average inductor current matches the new load current. While the top MOSFET is off, the bottom MOSFET is turned on until either the inductor current starts to reverse, as indicated by the current reversal comparator I_{RCMP} , or the beginning of the next clock cycle.

Burst Mode Operation

The LTC3406 is capable of Burst Mode operation in which the internal power MOSFETs operate intermittently based on load demand.

In Burst Mode operation, the peak current of the inductor is set to approximately 200mA regardless of the output load. Each burst event can last from a few cycles at light loads to almost continuously cycling with short sleep intervals at moderate loads. In between these burst events, the power MOSFETs and any unneeded circuitry are turned off, reducing the quiescent current to 20 μ A. In this sleep state, the load current is being supplied solely from the output capacitor. As the output voltage droops, the EA amplifier's output rises above the sleep threshold signaling the BURST comparator to trip and turn the top MOSFET on. This process repeats at a rate that is dependent on the load demand.

OPERATION (Refer to Functional Diagram)

Short-Circuit Protection

When the output is shorted to ground, the frequency of the oscillator is reduced to about 210kHz, 1/7 the nominal frequency. This frequency foldback ensures that the inductor current has more time to decay, thereby preventing runaway. The oscillator's frequency will progressively increase to 1.5MHz when V_{FB} or V_{OUT} rises above 0V.

Dropout Operation

As the input supply voltage decreases to a value approaching the output voltage, the duty cycle increases toward the maximum on-time. Further reduction of the supply voltage forces the main switch to remain on for more than one cycle until it reaches 100% duty cycle. The output voltage will then be determined by the input voltage minus the voltage drop across the P-channel MOSFET and the inductor.

An important detail to remember is that at low input supply voltages, the $R_{DS(ON)}$ of the P-channel switch increases (see Typical Performance Characteristics). Therefore, the user should calculate the power dissipation when the LTC3406 is used at 100% duty cycle with low input voltage (See Thermal Considerations in the Applications Information section).

Low Supply Operation

The LTC3406 will operate with input supply voltages as low as 2.5V, but the maximum allowable output current is reduced at this low voltage. Figure 2 shows the reduction

in the maximum output current as a function of input voltage for various output voltages.

Slope Compensation and Inductor Peak Current

Slope compensation provides stability in constant frequency architectures by preventing subharmonic oscillations at high duty cycles. It is accomplished internally by adding a compensating ramp to the inductor current signal at duty cycles in excess of 40%. Normally, this results in a reduction of maximum inductor peak current for duty cycles $>40\%$. However, the LTC3406 uses a patent-pending scheme that counteracts this compensating ramp, which allows the maximum inductor peak current to remain unaffected throughout all duty cycles.

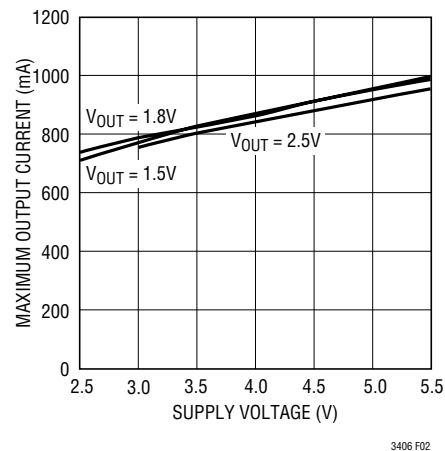

Figure 2. Maximum Output Current vs Input Voltage

APPLICATIONS INFORMATION

The basic LTC3406 application circuit is shown in Figure 1. External component selection is driven by the load requirement and begins with the selection of L followed by C_{IN} and C_{OUT} .

Inductor Selection

For most applications, the value of the inductor will fall in the range of 1 μ H to 4.7 μ H. Its value is chosen based on the desired ripple current. Large value inductors lower ripple current and small value inductors result in higher ripple currents. Higher V_{IN} or V_{OUT} also increases the ripple current as shown in equation 1. A reasonable starting point for setting ripple current is $\Delta I_L = 240\text{mA}$ (40% of 600mA).

$$\Delta I_L = \frac{1}{(f)(L)} V_{OUT} \left(1 - \frac{V_{OUT}}{V_{IN}} \right) \quad (1)$$

The DC current rating of the inductor should be at least equal to the maximum load current plus half the ripple current to prevent core saturation. Thus, a 720mA rated inductor should be enough for most applications (600mA + 120mA). For better efficiency, choose a low DC-resistance inductor.

The inductor value also has an effect on Burst Mode operation. The transition to low current operation begins when the inductor current peaks fall to approximately 200mA. Lower inductor values (higher ΔI_L) will cause this to occur at lower load currents, which can cause a dip in efficiency in the upper range of low current operation. In Burst Mode operation, lower inductance values will cause the burst frequency to increase.

Inductor Core Selection

Different core materials and shapes will change the size/current and price/current relationship of an inductor. Toroid or shielded pot cores in ferrite or permalloy materials are small and don't radiate much energy, but generally cost more than powdered iron core inductors with similar electrical characteristics. The choice of which style

inductor to use often depends more on the price vs size requirements and any radiated field/EMI requirements than on what the LTC3406 requires to operate. Table 1 shows some typical surface mount inductors that work well in LTC3406 applications.

Table 1. Representative Surface Mount Inductors

PART NUMBER	VALUE (μ H)	DCR (Ω MAX)	MAX DC CURRENT (A)	SIZE $W \times L \times H$ (mm ³)
Sumida CDRH3D16	1.5	0.043	1.55	3.8 × 3.8 × 1.8
	2.2	0.075	1.20	
	3.3	0.110	1.10	
	4.7	0.162	0.90	
Sumida CMD4D06	2.2	0.116	0.950	3.5 × 4.3 × 0.8
	3.3	0.174	0.770	
	4.7	0.216	0.750	
Panasonic ELT5KT	3.3	0.17	1.00	4.5 × 5.4 × 1.2
	4.7	0.20	0.95	
Murata LQH32CN	1.0	0.060	1.00	2.5 × 3.2 × 2.0
	2.2	0.097	0.79	
	4.7	0.150	0.65	

C_{IN} and C_{OUT} Selection

In continuous mode, the source current of the top MOSFET is a square wave of duty cycle V_{OUT}/V_{IN} . To prevent large voltage transients, a low ESR input capacitor sized for the maximum RMS current must be used. The maximum RMS capacitor current is given by:

$$C_{IN} \text{ required } I_{RMS} \cong I_{OMAX} \frac{[V_{OUT}(V_{IN} - V_{OUT})]^{1/2}}{V_{IN}}$$

This formula has a maximum at $V_{IN} = 2V_{OUT}$, where $I_{RMS} = I_{OUT}/2$. This simple worst-case condition is commonly used for design because even significant deviations do not offer much relief. Note that the capacitor manufacturer's ripple current ratings are often based on 2000 hours of life. This makes it advisable to further derate the capacitor, or choose a capacitor rated at a higher temperature than required. Always consult the manufacturer if there is any question.

APPLICATIONS INFORMATION

The selection of C_{OUT} is driven by the required effective series resistance (ESR).

Typically, once the ESR requirement for C_{OUT} has been met, the RMS current rating generally far exceeds the $I_{RIPPLE(P-P)}$ requirement. The output ripple ΔV_{OUT} is determined by:

$$\Delta V_{OUT} \cong \Delta I_L \left(ESR + \frac{1}{8fC_{OUT}} \right)$$

where f = operating frequency, C_{OUT} = output capacitance and ΔI_L = ripple current in the inductor. For a fixed output voltage, the output ripple is highest at maximum input voltage since ΔI_L increases with input voltage.

Aluminum electrolytic and dry tantalum capacitors are both available in surface mount configurations. In the case of tantalum, it is critical that the capacitors are surge tested for use in switching power supplies. An excellent choice is the AVX TPS series of surface mount tantalum. These are specially constructed and tested for low ESR so they give the lowest ESR for a given volume. Other capacitor types include Sanyo POSCAP, Kemet T510 and T495 series, and Sprague 593D and 595D series. Consult the manufacturer for other specific recommendations.

Using Ceramic Input and Output Capacitors

Higher values, lower cost ceramic capacitors are now becoming available in smaller case sizes. Their high ripple current, high voltage rating and low ESR make them ideal for switching regulator applications. Because the LTC3406's control loop does not depend on the output capacitor's ESR for stable operation, ceramic capacitors can be used **freely** to achieve very low output ripple and small circuit size.

However, care must be taken when ceramic capacitors are used at the input and the output. When a ceramic capacitor is used at the input and the power is supplied by a wall adapter through long wires, a load step at the output can

induce ringing at the input, V_{IN} . At best, this ringing can couple to the output and be mistaken as loop instability. At worst, a sudden inrush of current through the long wires can potentially cause a voltage spike at V_{IN} , large enough to damage the part.

When choosing the input and output ceramic capacitors, choose the X5R or X7R dielectric formulations. These dielectrics have the best temperature and voltage characteristics of all the ceramics for a given value and size.

Output Voltage Programming (LTC3406 Only)

In the adjustable version, the output voltage is set by a resistive divider according to the following formula:

$$V_{OUT} = 0.6V \left(1 + \frac{R2}{R1} \right) \quad (2)$$

The external resistive divider is connected to the output, allowing remote voltage sensing as shown in Figure 3.

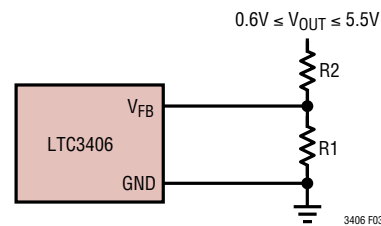

Figure 3. Setting the LTC3406 Output Voltage

Efficiency Considerations

The efficiency of a switching regulator is equal to the output power divided by the input power times 100%. It is often useful to analyze individual losses to determine what is limiting the efficiency and which change would produce the most improvement. Efficiency can be expressed as:

$$\text{Efficiency} = 100\% - (L1 + L2 + L3 + \dots)$$

where $L1$, $L2$, etc. are the individual losses as a percentage of input power.

APPLICATIONS INFORMATION

Although all dissipative elements in the circuit produce losses, two main sources usually account for most of the losses in LTC3406 circuits: V_{IN} quiescent current and I^2R losses. The V_{IN} quiescent current loss dominates the efficiency loss at very low load currents whereas the I^2R loss dominates the efficiency loss at medium to high load currents. In a typical efficiency plot, the efficiency curve at very low load currents can be misleading since the actual power lost is of no consequence as illustrated in Figure 4.

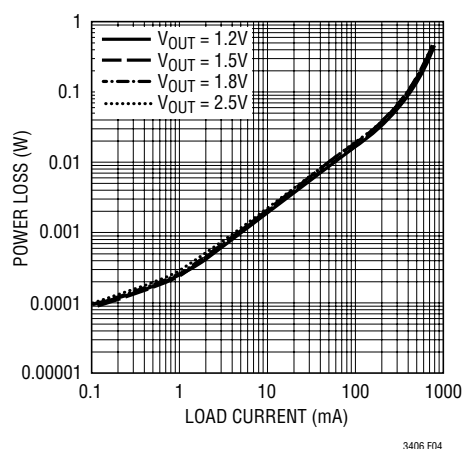

Figure 4. Power Lost vs Load Current

1. The V_{IN} quiescent current is due to two components: the DC bias current as given in the electrical characteristics and the internal main switch and synchronous switch gate charge currents. The gate charge current results from switching the gate capacitance of the internal power MOSFET switches. Each time the gate is switched from high to low to high again, a packet of charge, dQ , moves from V_{IN} to ground. The resulting dQ/dt is the current out of V_{IN} that is typically larger than the DC bias current. In continuous mode, $I_{GATECHG} = f(Q_T + Q_B)$ where Q_T and Q_B are the gate charges of the internal top and bottom switches. Both the DC bias and gate charge losses are proportional to V_{IN} and thus their effects will be more pronounced at higher supply voltages.

2. I^2R losses are calculated from the resistances of the internal switches, R_{SW} , and external inductor R_L . In continuous mode, the average output current flowing through inductor L is “chopped” between the main switch and the synchronous switch. Thus, the series resistance looking into the SW pin is a function of both top and bottom MOSFET $R_{DS(ON)}$ and the duty cycle (DC) as follows:

$$R_{SW} = (R_{DS(ON)TOP})(DC) + (R_{DS(ON)BOT})(1 - DC)$$

The $R_{DS(ON)}$ for both the top and bottom MOSFETs can be obtained from the Typical Performance Characteristics curves. Thus, to obtain I^2R losses, simply add R_{SW} to R_L and multiply the result by the square of the average output current.

Other losses including C_{IN} and C_{OUT} ESR dissipative losses and inductor core losses generally account for less than 2% total additional loss.

Thermal Considerations

In most applications the LTC3406 does not dissipate much heat due to its high efficiency. But, in applications where the LTC3406 is running at high ambient temperature with low supply voltage and high duty cycles, such as in dropout, the heat dissipated may exceed the maximum junction temperature of the part. If the junction temperature reaches approximately 150°C, both power switches will be turned off and the SW node will become high impedance.

To avoid the LTC3406 from exceeding the maximum junction temperature, the user will need to do some thermal analysis. The goal of the thermal analysis is to determine whether the power dissipated exceeds the maximum junction temperature of the part. The temperature rise is given by:

$$T_R = (P_D)(\theta_{JA})$$

where P_D is the power dissipated by the regulator and θ_{JA} is the thermal resistance from the junction of the die to the ambient temperature.

APPLICATIONS INFORMATION

The junction temperature, T_J , is given by:

$$T_J = T_A + T_R$$

where T_A is the ambient temperature.

As an example, consider the LTC3406 in dropout at an input voltage of 2.7V, a load current of 600mA and an ambient temperature of 70°C. From the typical performance graph of switch resistance, the $R_{DS(ON)}$ of the P-channel switch at 70°C is approximately 0.52Ω. Therefore, power dissipated by the part is:

$$P_D = I_{LOAD}^2 \cdot R_{DS(ON)} = 187.2\text{mW}$$

For the SOT-23 package, the θ_{JA} is 250°C/W. Thus, the junction temperature of the regulator is:

$$T_J = 70^\circ\text{C} + (0.1872)(250) = 116.8^\circ\text{C}$$

which is below the maximum junction temperature of 125°C.

Note that at higher supply voltages, the junction temperature is lower due to reduced switch resistance ($R_{DS(ON)}$).

Checking Transient Response

The regulator loop response can be checked by looking at the load transient response. Switching regulators take several cycles to respond to a step in load current. When a load step occurs, V_{OUT} immediately shifts by an amount equal to $(\Delta I_{LOAD} \cdot ESR)$, where ESR is the effective series resistance of C_{OUT} . ΔI_{LOAD} also begins to charge or discharge C_{OUT} , which generates a feedback error signal. The regulator loop then acts to return V_{OUT} to its steady-state value. During this recovery time V_{OUT} can be monitored for overshoot or ringing that would indicate a stability problem. For a detailed explanation of switching control loop theory, see Application Note 76.

A second, more severe transient is caused by switching in loads with large ($>1\mu\text{F}$) supply bypass capacitors. The discharged bypass capacitors are effectively put in parallel with C_{OUT} , causing a rapid drop in V_{OUT} . No regulator can deliver enough current to prevent this problem if the load switch resistance is low and it is driven quickly. The only solution is to limit the rise time of the switch drive so that the load rise time is limited to approximately $(25 \cdot C_{LOAD})$. Thus, a 10μF capacitor charging to 3.3V would require a 250μs rise time, limiting the charging current to about 130mA.

PC Board Layout Checklist

When laying out the printed circuit board, the following checklist should be used to ensure proper operation of the LTC3406. These items are also illustrated graphically in Figures 5 and 6. Check the following in your layout:

1. The power traces, consisting of the GND trace, the SW trace and the V_{IN} trace should be kept short, direct and wide.
2. Does the V_{FB} pin connect directly to the feedback resistors? The resistive divider R1/R2 must be connected between the (+) plate of C_{OUT} and ground.
3. Does the (+) plate of C_{IN} connect to V_{IN} as closely as possible? This capacitor provides the AC current to the internal power MOSFETs.
4. Keep the switching node, SW, away from the sensitive V_{FB} node.
5. Keep the (–) plates of C_{IN} and C_{OUT} as close as possible.

APPLICATIONS INFORMATION

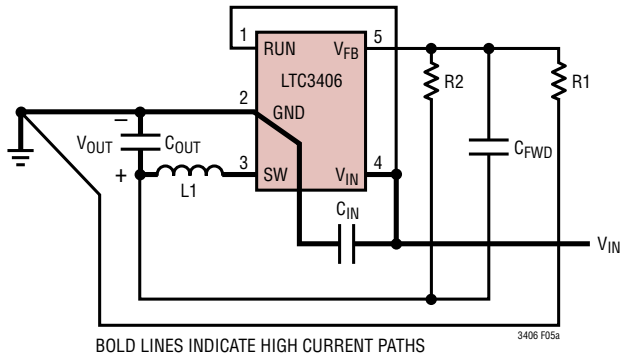

Figure 5a. LTC3406 Layout Diagram

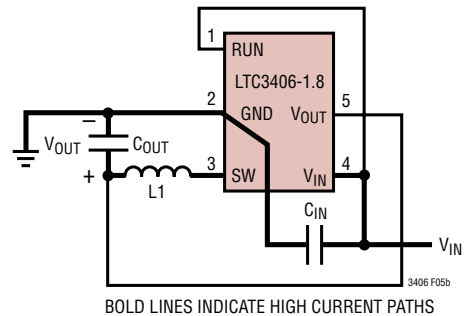

Figure 5b. LTC3406-1.8 Layout Diagram

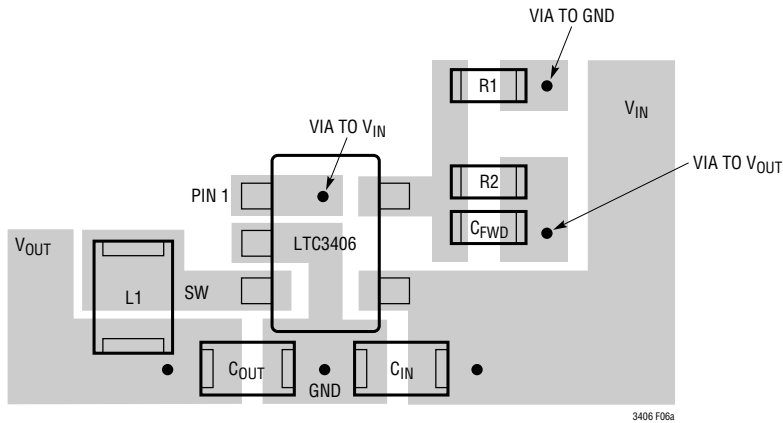

Figure 6a. LTC3406 Suggested Layout

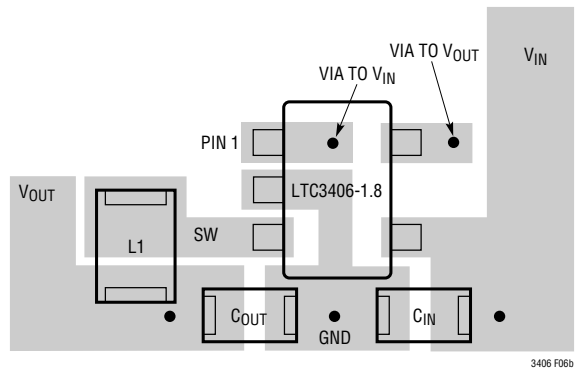

Figure 6b. LTC3406-1.8 Suggested Layout

Design Example

As a design example, assume the LTC3406 is used in a single lithium-ion battery-powered cellular phone application. The V_{IN} will be operating from a maximum of 4.2V down to about 2.7V. The load current requirement is a maximum of 0.6A but most of the time it will be in standby mode, requiring only 2mA. Efficiency at both low and high load currents is important. Output voltage is 2.5V. With this information we can calculate L using equation (1),

$$L = \frac{1}{(f)(\Delta I_L)} V_{OUT} \left(1 - \frac{V_{OUT}}{V_{IN}} \right) \quad (3)$$

Substituting $V_{OUT} = 2.5V$, $V_{IN} = 4.2V$, $\Delta I_L = 240mA$ and $f = 1.5MHz$ in equation (3) gives:

$$L = \frac{2.5V}{1.5MHz(240mA)} \left(1 - \frac{2.5V}{4.2V} \right) = 2.81\mu H$$

A 2.2 μH inductor works well for this application. For best efficiency choose a 720mA or greater inductor with less than 0.2 Ω series resistance.

C_{IN} will require an RMS current rating of at least $0.3A \cong I_{LOAD(MAX)}/2$ at temperature and C_{OUT} will require an ESR of less than 0.25 Ω . In most cases, a ceramic capacitor will satisfy this requirement.

APPLICATIONS INFORMATION

For the feedback resistors, choose $R1 = 316k$. $R2$ can then be calculated from equation (2) to be:

$$R2 = \left(\frac{V_{OUT}}{0.6} - 1 \right) R1 = 1000k$$

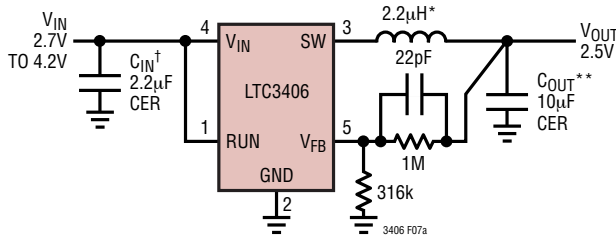

* MURATA LQH32CN2R2M33
** TAIYO YUDEN JMK316BJ106ML
† TAIYO YUDEN LMK212BJ225MG

Figure 7a

Figure 7 shows the complete circuit along with its efficiency curve.

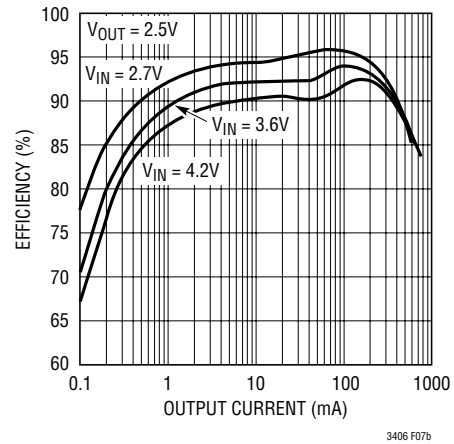
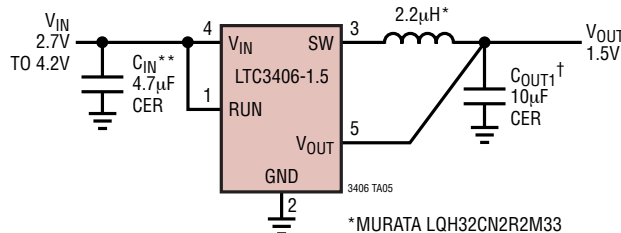

Figure 7b

TYPICAL APPLICATIONS

Single Li-Ion 1.5V/600mA Regulator for High Efficiency and Small Footprint



* MURATA LQH32CN2R2M33
** TAIYO YUDEN JMK212BJ475MG
† TAIYO YUDEN JMK316BJ106ML

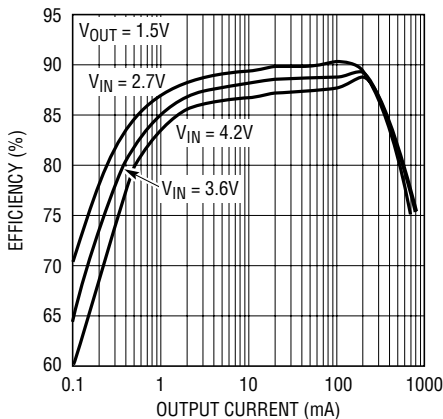

3406 TA06

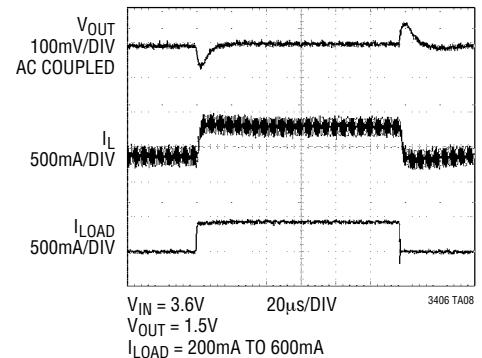
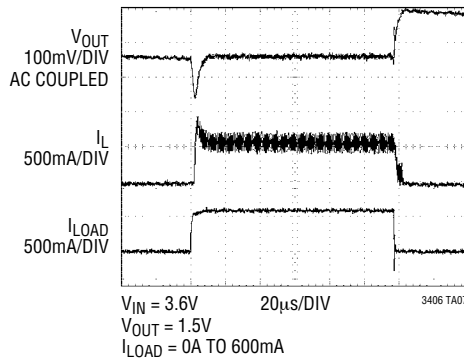

3406fa

TYPICAL APPLICATIONS

Single Li-Ion 1.2V/600mA Regulator for High Efficiency and Small Footprint

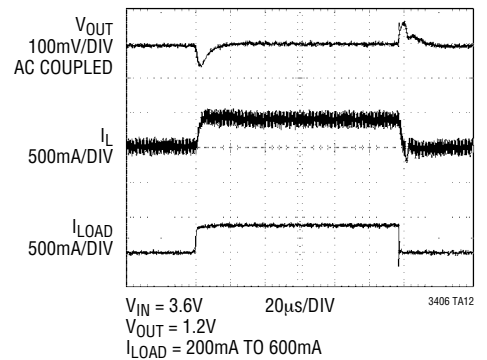
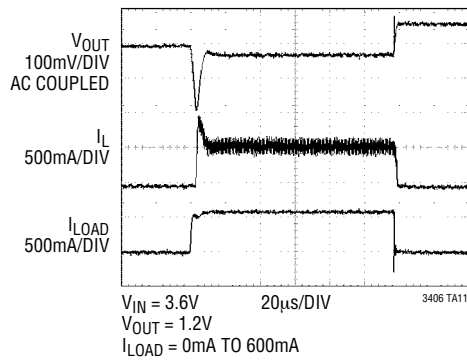
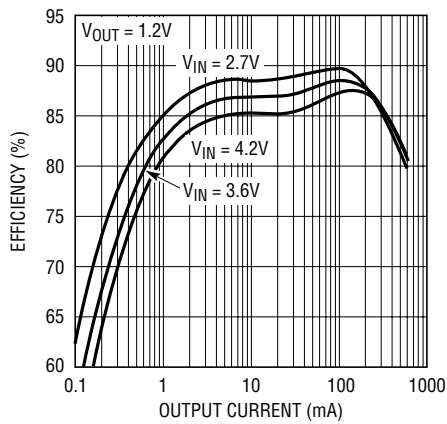
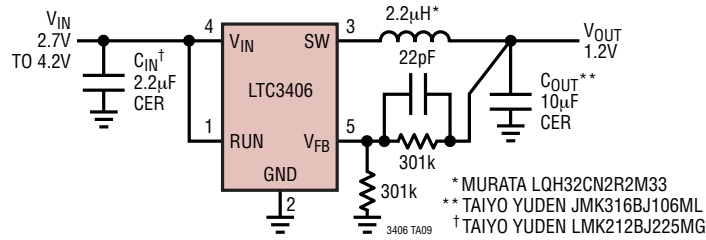

Tiny 3.3V/600mA Buck Regulator

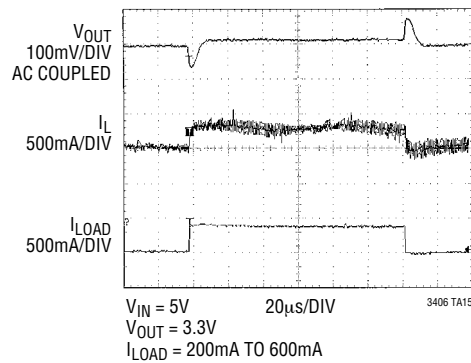
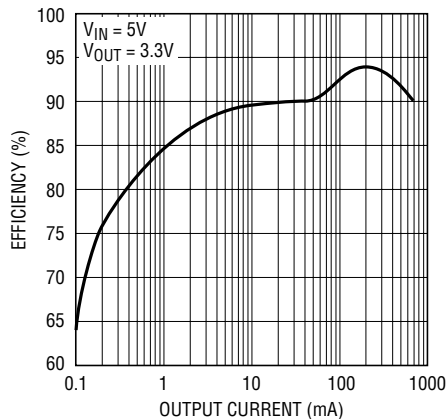
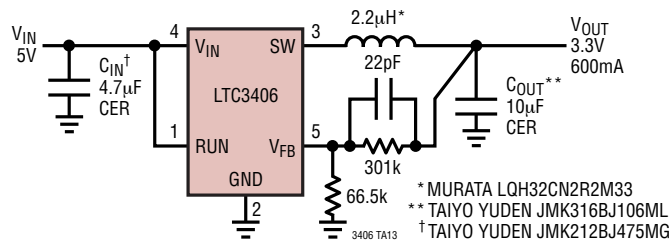

PACKAGE DESCRIPTION

S5 Package
5-Lead Plastic TSOT-23
(Reference LTC DWG # 05-08-1635)

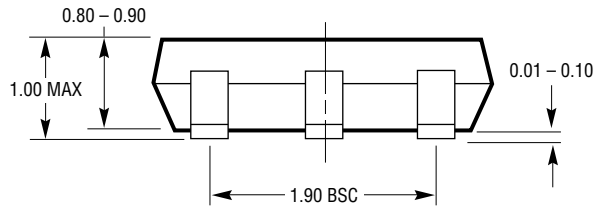
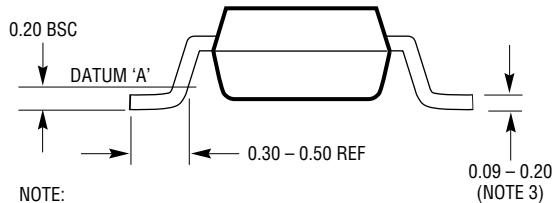
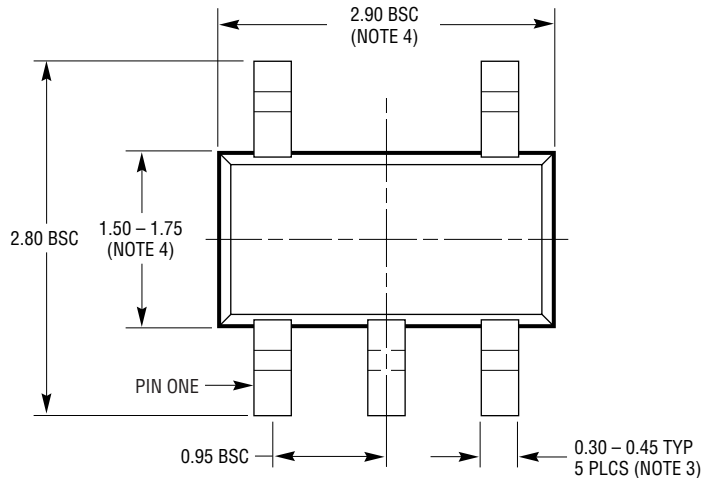
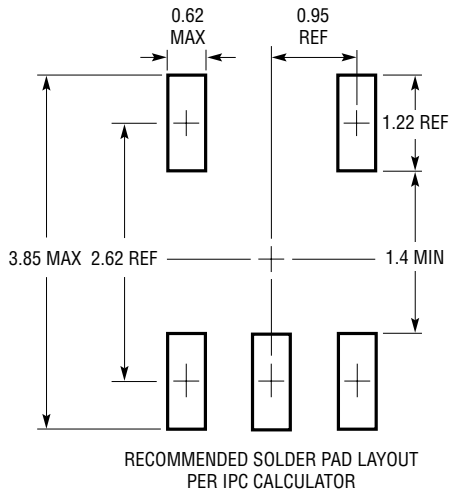

- NOTE:
1. DIMENSIONS ARE IN MILLIMETERS
 2. DRAWING NOT TO SCALE
 3. DIMENSIONS ARE INCLUSIVE OF PLATING
 4. DIMENSIONS ARE EXCLUSIVE OF MOLD FLASH AND METAL BURR
 5. MOLD FLASH SHALL NOT EXCEED 0.254mm
 6. JEDEC PACKAGE REFERENCE IS MO-193

S5 TSOT-23 0302

TYPICAL APPLICATION

Single Li-Ion 1.8V/600mA Regulator for Low Output Ripple and Small Footprint

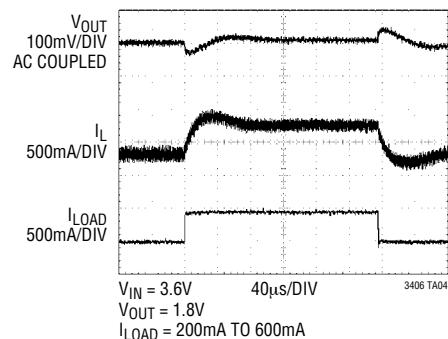
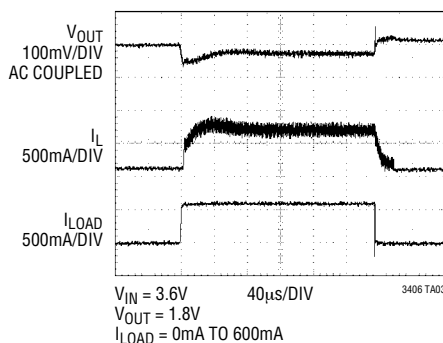
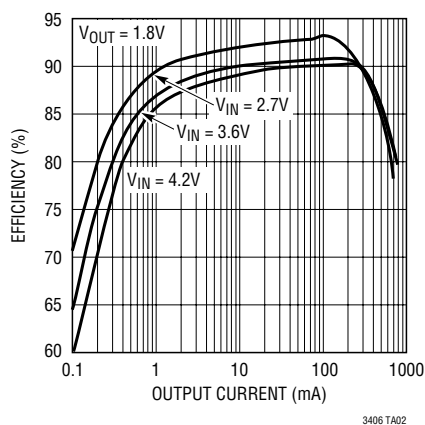
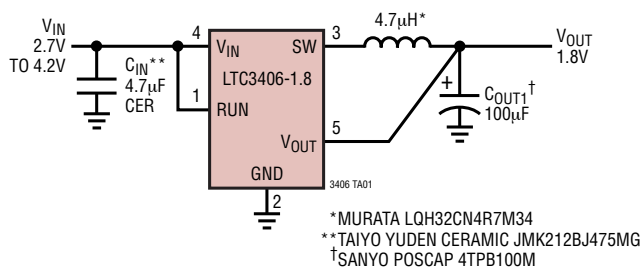

RELATED PARTS

PART NUMBER	DESCRIPTION	COMMENTS
LTC1474/LTC1475	250mA (I_{OUT}) Low Quiescent Current Step-Down DC/DC Converters	V_{IN} : 3V to 18V, Constant Off-Time, $I_Q = 10\mu A$, MS8 Package
LT1616	1.4MHz, 600mA Step-Down DC/DC Converter	V_{IN} : 3.6V to 25V, $I_Q = 1.9mA$, ThinSOT Package
LTC1701	1MHz, 500mA (I_{OUT}) Step-Down DC/DC Converter	V_{IN} : 2.5V to 5.5V, Constant Off-Time, $I_Q = 135\mu A$, ThinSOT Package
LTC1767	1.5A, 1.25MHz Step-Down Switching Regulator	V_{IN} : 3V to 25V, $I_Q = 1mA$, MS8/E Packages
LTC1779	550kHz, 250mA (I_{OUT}) Step-Down Switching Regulator	V_{IN} : 2.5V to 9.8V, $I_Q = 135\mu A$, ThinSOT Package
LTC1875	550kHz, 1.2A (I_{OUT}) Synchronous Step-Down Regulator	V_{IN} : 2.7V to 6V, $I_Q = 15\mu A$, TSSOP-16 Package
LTC1877	550kHz, 600mA (I_{OUT}) Synchronous Step-Down Regulator	V_{IN} : 2.65V to 10V, $I_Q = 10\mu A$, MS8 Package
LTC1878	550kHz, 600mA (I_{OUT}) Synchronous Step-Down Regulator	V_{IN} : 2.65V to 6V, $I_Q = 10\mu A$, MS8 Package
LTC1879	550kHz, 1.2A (I_{OUT}) Synchronous Step-Down Regulator	V_{IN} : 2.7V to 10V, $I_Q = 15\mu A$, TSSOP-16 Package
LTC3404	1.4MHz, 600mA (I_{OUT}) Synchronous Monolithic Step-Down Regulator	Up to 95% Efficiency, V_{IN} : 2.65V to 6V, $I_Q = 10\mu A$, MS8 Package
LTC3405/LTC3405A LTC3405A-1.5 LTC3405A-1.8	1.5MHz, 300mA (I_{OUT}) Synchronous Monolithic Step-Down Regulators	Up to 95% Efficiency, V_{IN} : 2.5V to 5.5V, $I_Q = 20\mu A$, Fixed Output Voltages Available, ThinSOT Package
LTC3406B LTC3406B-1.5 LTC3406B-1.8	1.5MHz, 600mA (I_{OUT}) Synchronous Monolithic Step-Down Regulators	Up to 95% Efficiency, with Pulse Skipping Mode Fixed Output Voltages Available, ThinSOT Package
LTC3411	4MHz, 1.25A (I_{OUT}) Synchronous Monolithic Step-Down Regulator	Up to 95% Efficiency, V_{IN} : 2.5V to 5.5V, $I_Q = 60\mu A$, MS Package
LTC3412	4MHz, 2.5A (I_{OUT}) Synchronous Monolithic Step-Down Regulator	Up to 95% Efficiency, V_{IN} : 2.5V to 5.5V, $I_Q = 60\mu A$, TSSOP Package

3406fa