

FEATURES

- Unity-Gain Stable
- 45MHz Gain-Bandwidth
- 400V/ μ s Slew Rate
- 7V/mV DC Gain: $R_L = 500\Omega$
- Maximum Input Offset Voltage: 2mV
- $\pm 12V$ Minimum Output Swing into 500Ω
- Wide Supply Range: $\pm 2.5V$ to $\pm 15V$
- 7mA Supply Current
- 90ns Settling Time to 0.1%, 10V Step
- Drives All Capacitive Loads

APPLICATIONS

- Wideband Amplifiers
- Buffers
- Active Filters
- Video and RF Amplification
- Cable Drivers
- Data Acquisition Systems

DESCRIPTION

The LT1224 is a very high speed operational amplifier with excellent DC performance. The LT1224 features reduced input offset voltage and higher DC gain than devices with comparable bandwidth and slew rate. The circuit is a single gain stage with outstanding settling characteristics. The fast settling time makes the circuit an ideal choice for data acquisition systems. The output is capable of driving a 500Ω load to $\pm 12V$ with $\pm 15V$ supplies and a 150Ω load to $\pm 3V$ on $\pm 5V$ supplies. The circuit is also capable of driving large capacitive loads which makes it useful in buffer or cable driver applications.

The LT1224 is a member of a family of fast, high performance amplifiers that employ Linear Technology Corporation's advanced bipolar complementary processing.

TYPICAL APPLICATION

DAC Current-to-Voltage Converter

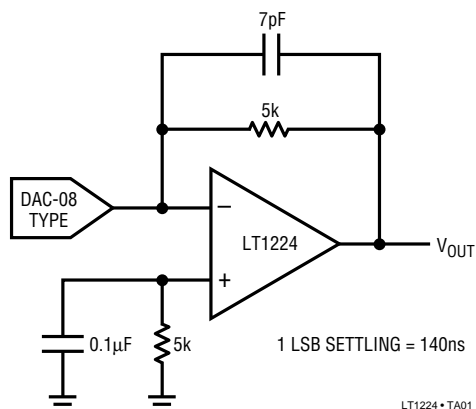

Inverter Pulse Response

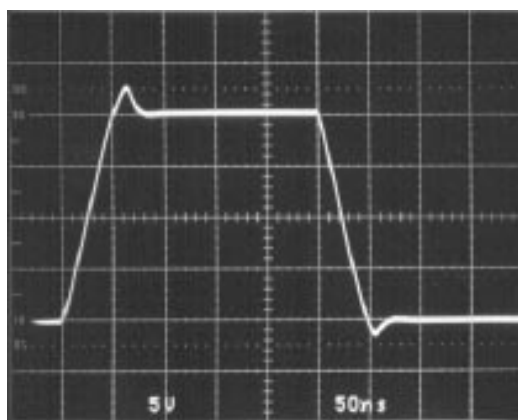

ABSOLUTE MAXIMUM RATINGS

Total Supply Voltage (V^+ to V^-)	36V
Differential Input Voltage	$\pm 6V$
Input Voltage	$\pm V_S$
Output Short Circuit Duration (Note 1)	Indefinite
Operating Temperature Range	
LT1224C	0°C to 70°C
Maximum Junction Temperature	
Plastic Package	150°C
Storage Temperature Range	- 65°C to 150°C
Lead Temperature (Soldering, 10 sec.)	300°C

PACKAGE/ORDER INFORMATION

<p>TOP VIEW</p> <p>NULL 1 8 NULL</p> <p>-IN 2 7 V+</p> <p>+IN 3 6 OUT</p> <p>V- 4 5 NC</p> <p>N8 PACKAGE S8 PACKAGE</p> <p>8-LEAD PLASTIC DIP 8-LEAD PLASTIC SOIC</p> <p>LT1224 • POI01</p> <p>T_{JMAX} = 150°C, θ_{JA} = 100°C/W (N8)</p> <p>T_{JMAX} = 150°C, θ_{JA} = 150°C/W (S8)</p>	ORDER PART NUMBER
	LT1224CN8 LT1224CS8
	S8 PART MARKING
	1224

ELECTRICAL CHARACTERISTICS $V_S = \pm 15V$, $T_A = 25^\circ C$, $R_L = 1k$, $V_{CM} = 0V$ unless otherwise noted.

SYMBOL	PARAMETER	CONDITIONS	MIN	TYP	MAX	UNITS
V_{OS}	Input Offset Voltage	(Note 2)		0.5	2.0	mV
I_{OS}	Input Offset Current			100	400	nA
I_B	Input Bias Current			4	8	μA
e_n	Input Noise Voltage	$f = 10kHz$		22		nV/\sqrt{Hz}
i_n	Input Noise Current	$f = 10kHz$		1.5		pA/\sqrt{Hz}
R_{IN}	Input Resistance	$V_{CM} = \pm 12V$ Differential	24	40 250		M Ω k Ω
C_{IN}	Input Capacitance			2		pF
	Input Voltage Range ⁺		12	14		V
	Input Voltage Range ⁻			-13	-12	V
CMRR	Common-Mode Rejection Ratio	$V_{CM} = \pm 12V$	86	100		dB
PSRR	Power Supply Rejection Ratio	$V_S = \pm 5V$ to $\pm 15V$	75	84		dB
A_{VOL}	Large-Signal Voltage Gain	$V_{OUT} = \pm 10V$, $R_L = 500\Omega$	3.3	7		V/mV
V_{OUT}	Output Swing	$R_L = 500\Omega$	± 12.0	± 13.3		V
I_{OUT}	Output Current	$V_{OUT} = \pm 12V$	24	40		mA
SR	Slew Rate	$A_{VCL} = -2$, (Note 3)	250	400		V/ μs
	Full Power Bandwidth	10V Peak, (Note 4)		6.4		MHz
GBW	Gain-Bandwidth	$f = 1MHz$		45		MHz
t_r , t_f	Rise Time, Fall Time	$A_{VCL} = 1$, 10% to 90%, 0.1V		5		ns
	Overshoot	$A_{VCL} = 1$, 0.1V		30		%
	Propagation Delay	50% V_{IN} to 50% V_{OUT}		5		ns
t_s	Settling Time	10V Step, 0.1%		90		ns
	Differential Gain	$f = 3.58MHz$, $R_L = 150\Omega$		1		%
	Differential Phase	$f = 3.58MHz$, $R_L = 150\Omega$		2.4		Deg
R_O	Output Resistance	$A_{VCL} = 1$, $f = 1MHz$		2.5		Ω
I_S	Supply Current			7	9	mA

ELECTRICAL CHARACTERISTICS $V_S = \pm 5V$, $T_A = 25^\circ C$, $R_L = 1k$, $V_{CM} = 0V$ unless otherwise noted.

SYMBOL	PARAMETER	CONDITIONS	MIN	TYP	MAX	UNITS
V_{OS}	Input Offset Voltage	(Note 2)		1	4	mV
I_{OS}	Input Offset Current			100	400	nA
I_B	Input Bias Current			4	8	μA
	Input Voltage Range ⁺		2.5	4		V
	Input Voltage Range ⁻			-3	-2.5	V
CMRR	Common-Mode Rejection Ratio	$V_{CM} = \pm 2.5V$	86	98		dB
A_{VOL}	Large-Signal Voltage Gain	$V_{OUT} = \pm 2.5V$, $R_L = 500\Omega$ $V_{OUT} = \pm 2.5V$, $R_L = 150\Omega$	2.5	7 3		V/mV V/mV
V_{OUT}	Output Swing	$R_L = 500\Omega$ $R_L = 150\Omega$	± 3.0 ± 3.0	± 3.7 ± 3.3		V V
I_{OUT}	Output Current	$V_{OUT} = \pm 3V$	20	40		mA
SR	Slew Rate	$A_{VCL} = -2$, (Note 3)		250		V/ μs
	Full Power Bandwidth	3V Peak, (Note 4)		13.3		MHz
GBW	Gain-Bandwidth	$f = 1MHz$		34		MHz
t_r , t_f	Rise Time, Fall Time	$A_{VCL} = 1$, 10% to 90%, 0.1V		7		ns
	Overshoot	$A_{VCL} = 1$, 0.1V		20		%
	Propagation Delay	50% V_{IN} to 50% V_{OUT}		7		ns
t_s	Settling Time	-2.5V to 2.5V, 0.1%		90		ns
I_S	Supply Current			7	9	mA

ELECTRICAL CHARACTERISTICS $0^\circ C \leq T_A \leq 70^\circ C$, $R_L = 1k$, $V_{CM} = 0V$ unless otherwise noted.

SYMBOL	PARAMETER	CONDITIONS	MIN	TYP	MAX	UNITS
V_{OS}	Input Offset Voltage	$V_S = \pm 15V$, (Note 2) $V_S = \pm 5V$, (Note 2)		1 2	4 5	mV mV
	Input V_{OS} Drift			25		$\mu V/^\circ C$
I_{OS}	Input Offset Current	$V_S = \pm 15V$ and $V_S = \pm 5V$		100	600	nA
I_B	Input Bias Current	$V_S = \pm 15V$ and $V_S = \pm 5V$		4	9	μA
CMRR	Common-Mode Rejection Ratio	$V_S = \pm 15V$, $V_{CM} = \pm 12V$ and $V_S = \pm 5V$, $V_{CM} = \pm 2.5V$	83	98		dB
PSRR	Power Supply Rejection Ratio	$V_S = \pm 5V$ to $\pm 15V$	73	84		dB
A_{VOL}	Large-Signal Voltage Gain	$V_S = \pm 15V$, $V_{OUT} = \pm 10V$, $R_L = 500\Omega$ $V_S = \pm 5V$, $V_{OUT} = \pm 2.5V$, $R_L = 500\Omega$	2.5 2.0	7 7		V/mV V/mV
V_{OUT}	Output Swing	$V_S = \pm 15V$, $R_L = 500\Omega$ $V_S = \pm 5V$, $R_L = 500\Omega$ or 150Ω	± 12.0 ± 3.0	± 13.3 ± 3.3		V V
I_{OUT}	Output Current	$V_S = \pm 15V$, $V_{OUT} = \pm 12V$ $V_S = \pm 5V$, $V_{OUT} = \pm 3V$	24 20	40 40		mA mA
SR	Slew Rate	$V_S = \pm 15V$, $A_{VCL} = -2$, (Note 3)	250	400		V/ μs
I_S	Supply Current	$V_S = \pm 15V$ and $V_S = \pm 5V$		7	10.5	mA

Note 1: A heat sink may be required to keep the junction temperature below absolute maximum when the output is shorted indefinitely.

Note 2: Input offset voltage is tested with automated test equipment in <1 second.

Note 3: Slew rate is measured in a gain of -2 between $\pm 10V$ on the output with $\pm 6V$ on the input for $\pm 15V$ supplies and $\pm 2V$ on the output with $\pm 1.75V$ on the input for $\pm 5V$ supplies.

Note 4: Full power bandwidth is calculated from the slew rate measurement: $FPBW = SR/2\pi V_p$.

TYPICAL PERFORMANCE CHARACTERISTICS

Input Common-Mode Range vs Supply Voltage

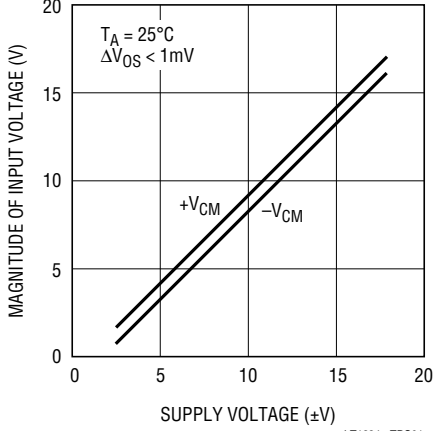

Supply Current vs Supply Voltage

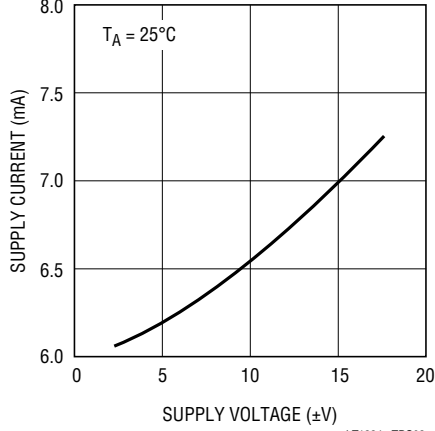

Output Voltage Swing vs Supply Voltage

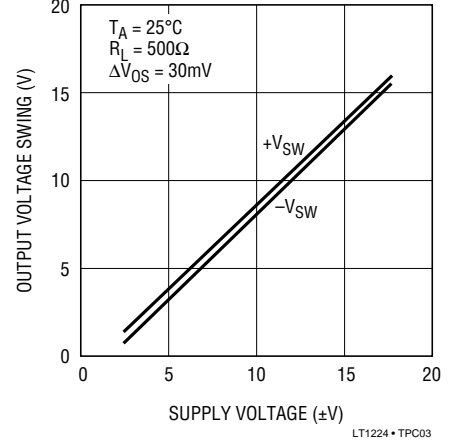

Output Voltage Swing vs Resistive Load

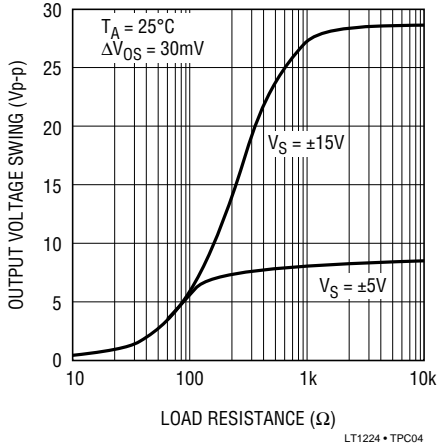

Input Bias Current vs Input Common-Mode Voltage

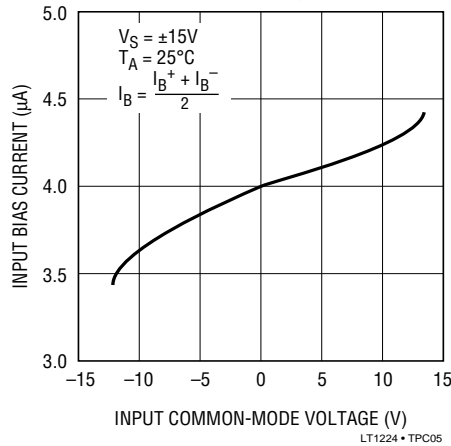

Open-Loop Gain vs Resistive Load

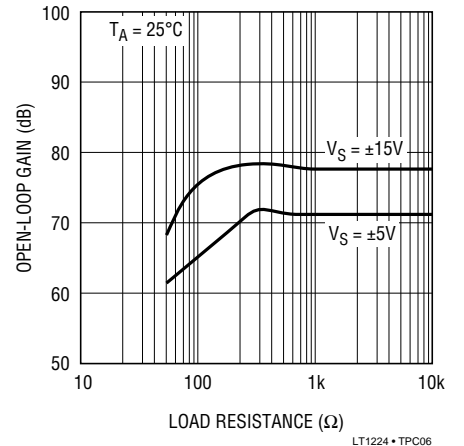

Supply Current vs Temperature

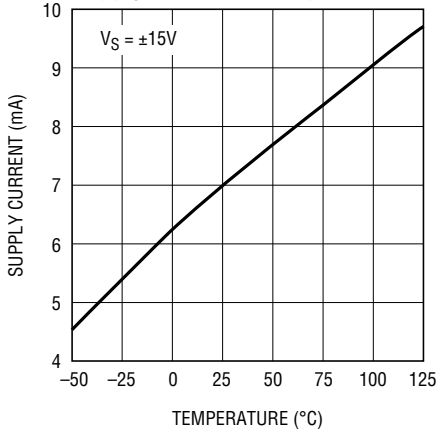

Input Bias Current vs Temperature

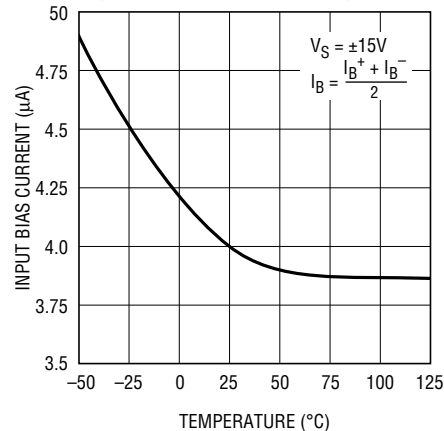

Output Short Circuit Current vs Temperature

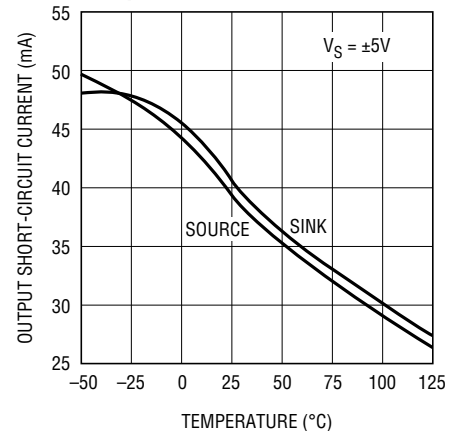

TYPICAL PERFORMANCE CHARACTERISTICS

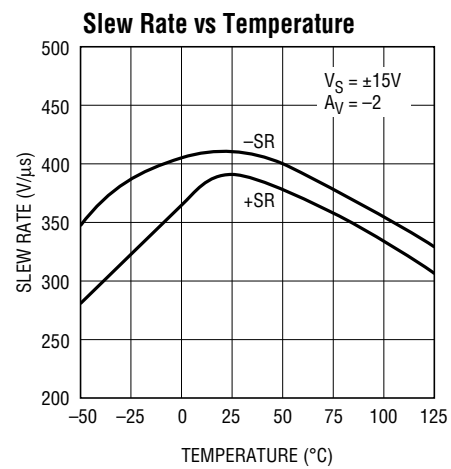
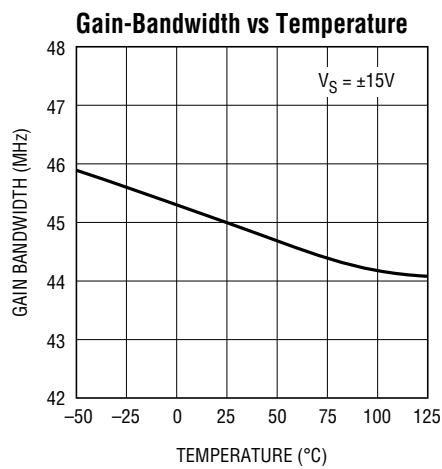
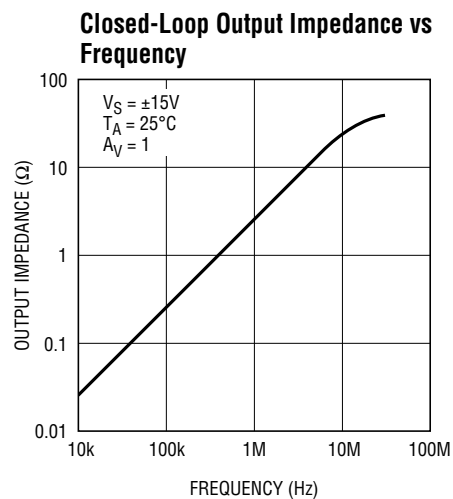
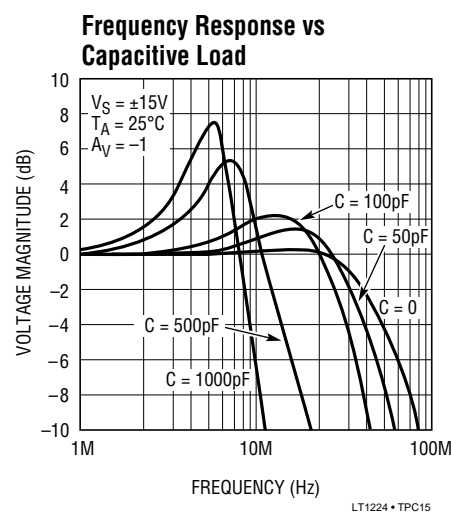
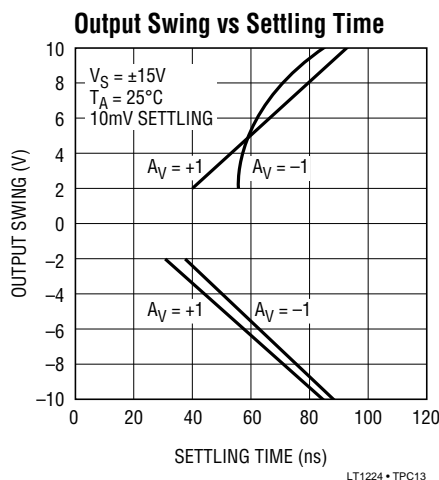
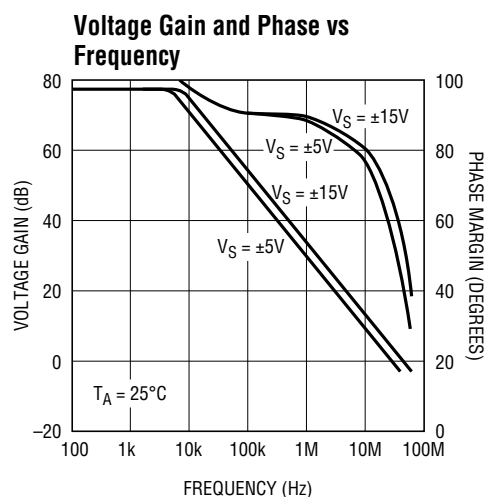
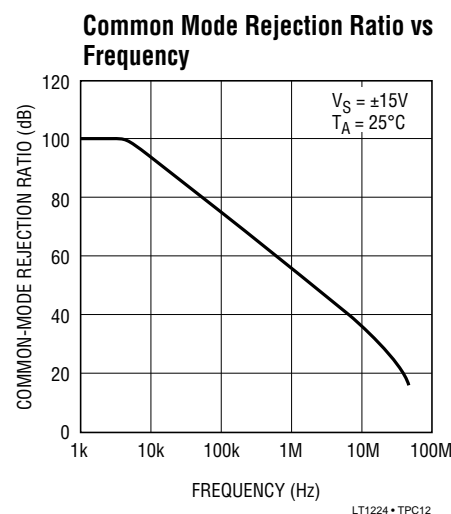
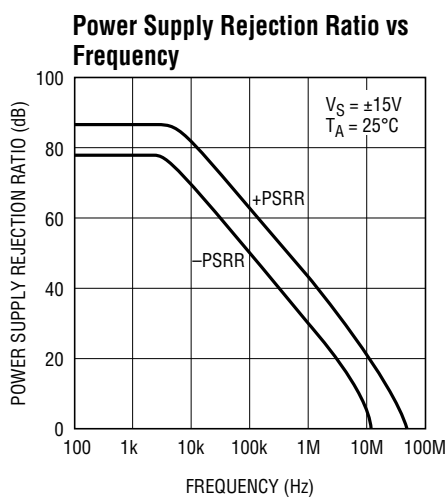
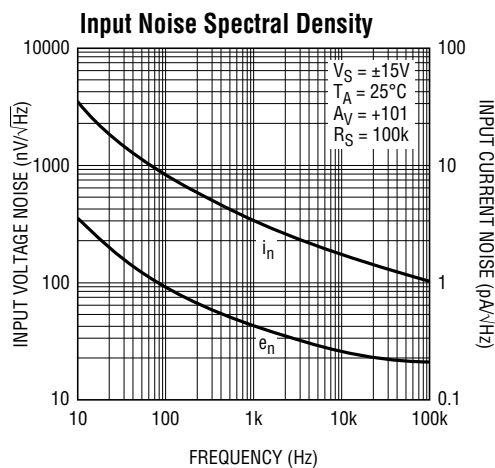

APPLICATIONS INFORMATION

The LT1224 may be inserted directly into HA2541, HA2544, AD847, EL2020 and LM6361 applications, provided that the nulling circuitry is removed. The suggested nulling circuit for the LT1224 is shown below.

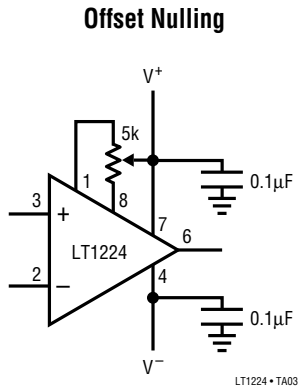

Layout and Passive Components

As with any high speed operational amplifier, care must be taken in board layout in order to obtain maximum performance. Key layout issues include: use of a ground plane, minimization of stray capacitance at the input pins, short lead lengths, RF-quality bypass capacitors located close to the device (typically 0.01µF to 0.1µF), and use of low ESR bypass capacitors for high drive current applications (typically 1µF to 10µF tantalum). Sockets should be avoided when maximum frequency performance is required, although low profile sockets can provide reasonable performance up to 50MHz. For more details see Design Note 50. Feedback resistor values greater than 5k are not recommended because a pole is formed with the input capacitance which can cause peaking. If feedback resistors greater than 5k are used, a parallel capacitor of 5pF to 10pF should be used to cancel the input pole and optimize dynamic performance.

Transient Response

The LT1224 gain bandwidth is 45MHz when measured at $f = 1\text{MHz}$. The actual frequency response in unity-gain is considerably higher than 45MHz due to peaking caused by a second pole beyond the unity-gain crossover. This is reflected in the 50° phase margin and shows up as

overshoot in the unity-gain small-signal transient response. Higher noise gain configurations exhibit less overshoot as seen in the inverting gain of one response.

Small Signal, $A_V = 1$

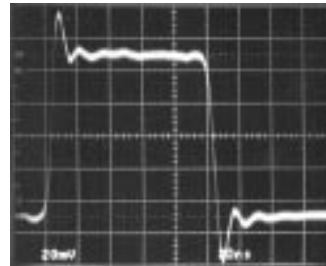

Small Signal, $A_V = -1$

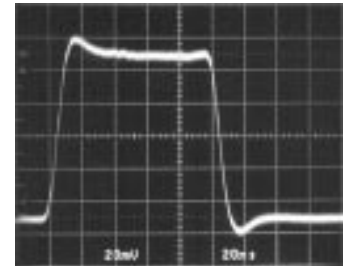

LT1224 • TA04

The large-signal responses in both inverting and non-inverting gain show symmetrical slewing characteristics. Normally the noninverting response has a much faster rising edge than falling edge due to the rapid change in input common-mode voltage which affects the tail current of the input differential pair. Slew enhancement circuitry has been added to the LT1224 so that the noninverting slew rate response is balanced.

Large Signal, $A_V = 1$

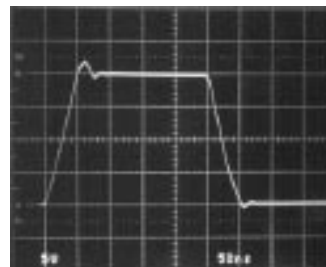

Large Signal, $A_V = -1$

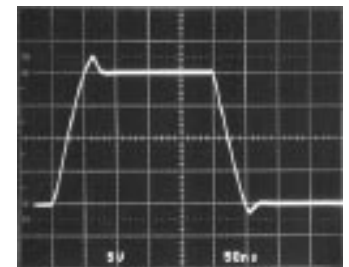

LT1224 • TA06

Input Considerations

Resistors in series with the inputs are recommended for the LT1224 in applications where the differential input voltage exceeds $\pm 6\text{V}$ continuously or on a transient basis. An example would be in noninverting configurations with high input slew rates or when driving heavy capacitive loads. The use of balanced source resistance at each input is recommended for applications where DC accuracy must be maximized.

APPLICATIONS INFORMATION

Capacitive Loading

The LT1224 is stable with all capacitive loads. This is accomplished by sensing the load induced output pole and adding compensation at the amplifier gain node. As the capacitive load increases, both the bandwidth and phase margin decrease so there will be peaking in the frequency domain and in the transient response. The photo of the small-signal response with 1000pF load shows 50% peaking. The large-signal response with a 10,000pF load shows the output slew rate being limited by the short-circuit current.

$A_V = -1, C_L = 1000\text{pF}$

$A_V = 1, C_L = 10,000\text{pF}$

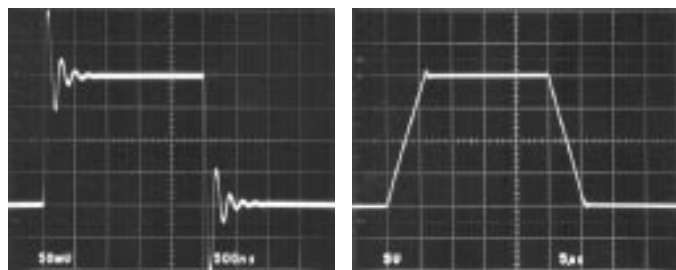

LT1224 • TA06

The LT1224 can drive coaxial cable directly, but for best pulse fidelity the cable should be doubly terminated with a resistor in series with the output.

Cable Driving

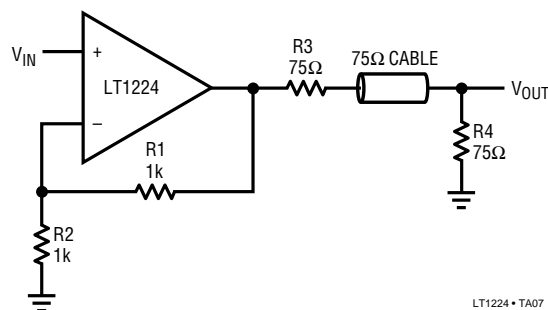

LT1224 • TA07

DAC Current-to-Voltage Converter

The wide bandwidth, high slew rate and fast settling time of the LT1224 make it well-suited for current-to-voltage conversion after current output D/A converters. A typical application is shown on the first page of this data sheet with a DAC-08 type converter with a full-scale output of 2mA. A compensation capacitor is used across the feedback resistor to null the pole at the inverting input caused by the DAC output capacitance. The combination of the LT1224 and DAC settles to 40mV in 140ns for both a 0V to 10V step and for a 10V to 0V step.

TYPICAL APPLICATIONS

1MHz, 2nd Order Butterworth Filter

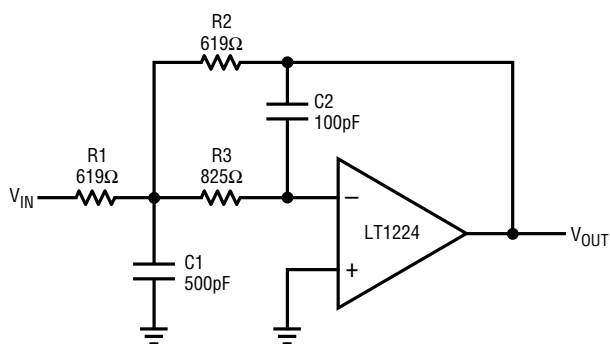

-38dB AT 10MHz
SMALL SIGNAL OVERSHOOT = 10%

LT1224 • TA08

Two Op Amp Instrumentation Amplifier

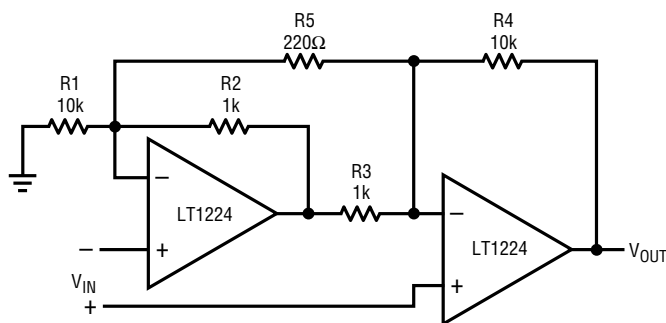

$$A_V = \frac{R_4}{R_3} \left[1 + \frac{1}{2} \left(\frac{R_2}{R_1} + \frac{R_3}{R_4} \right) + \frac{R_2 + R_3}{R_5} \right] = 102$$

TRIM R5 FOR GAIN
TRIM R1 FOR COMMON-MODE REJECTION
BW = 430kHz

LT1224 • TA09

SIMPLIFIED SCHEMATIC

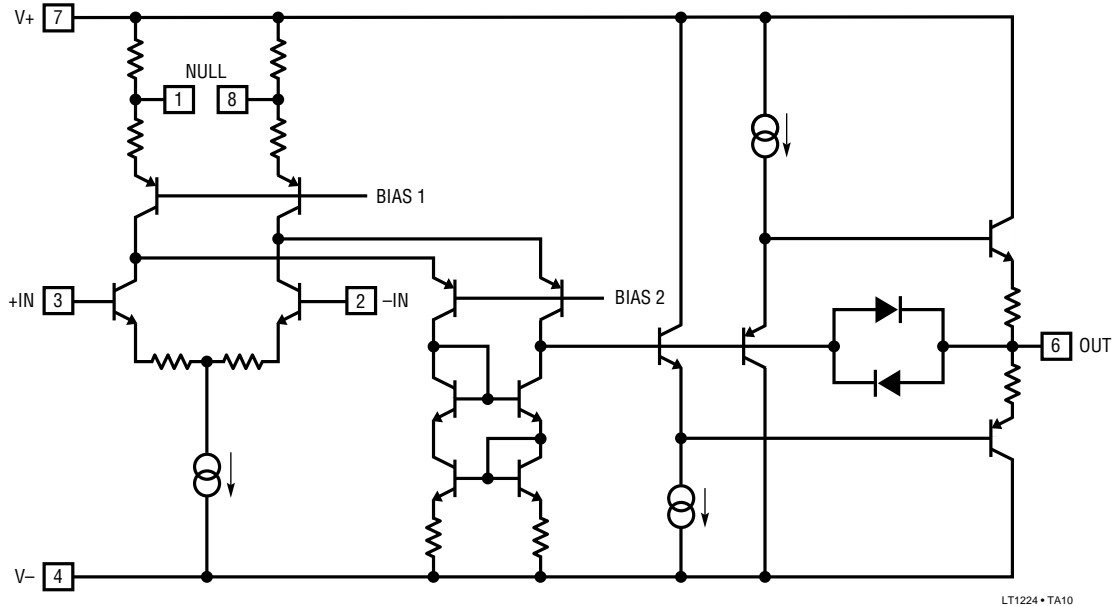

LT1224 • TA10

PACKAGE DESCRIPTION Dimensions in inches (millimeters) unless otherwise noted.

**N8 Package
8-Lead Plastic DIP**

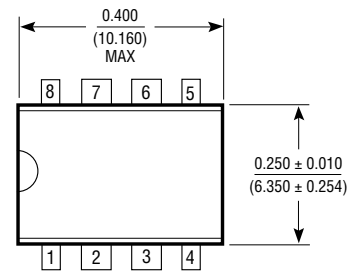
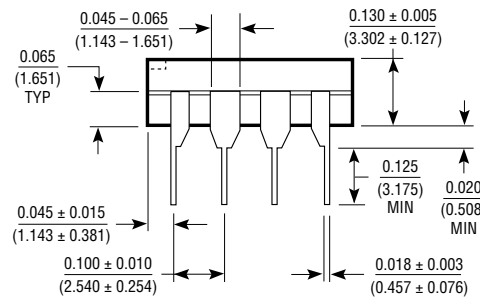
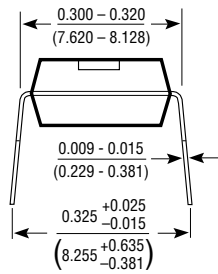

N8 1291

**S8 Package
8-Lead Plastic SOIC**

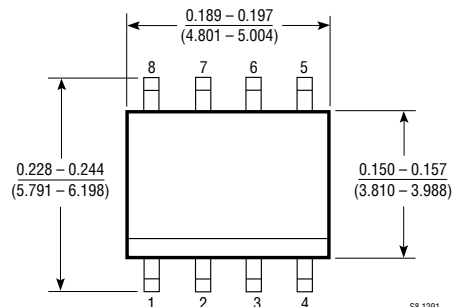
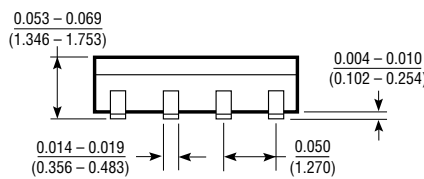
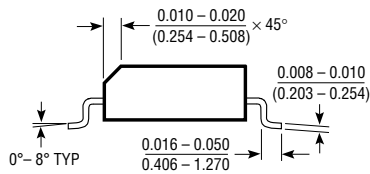

S8 1291