

LP4950C-5V and LP4951C Adjustable Micropower Voltage Regulators

 Check for Samples: [LP4950C-5V](#), [LP4951C](#)

FEATURES

- High Accuracy 5V Specified 100mA Output
- Extremely Low Quiescent Current
- Low Dropout Voltage
- Extremely Tight Load and Line Regulation
- Very Low Temperature Coefficient
- Use as Regulator or Reference
- Needs Only 1 μ F for Stability
- Current and Thermal Limiting

LP4951C VERSIONS ONLY

- Error Flag Warns of Output Dropout
- Logic-controlled Electronic Shutdown
- Output Programmable From 1.24 to 29V

DESCRIPTION

The LP4950C and LP4951C are micropower voltage regulators with very low quiescent current (75 μ A typ.) and very low dropout voltage (typ. 40mV at light loads and 380mV at 100mA). They are ideally suited for use in battery-powered systems. Furthermore, the quiescent current of the LP4950C/LP4951C increases only slightly in dropout, prolonging battery life.

The LP4950C in the popular 3-pin TO-92 package is pin compatible with older 5V regulators. The 8-lead LP4951C is available in a plastic surface mount package and offers additional system functions.

One such feature is an error flag output which warns of a low output voltage, often due to falling batteries on the input. It may be used for a power-on reset. A second feature is the logic-compatible shutdown input which enables the regulator to be switched on and off. Also, the part may be pin-strapped for a 5V output or programmed from 1.24V to 29V with an external pair of resistors.

Careful design of the LP4950C/LP4951C has minimized all contributions to the error budget. This includes a tight initial tolerance (.5% typ.), extremely good load and line regulation (.05% typ.) and a very low output voltage temperature coefficient, making the part useful as a low-power voltage reference.

BLOCK DIAGRAM AND TYPICAL APPLICATIONS

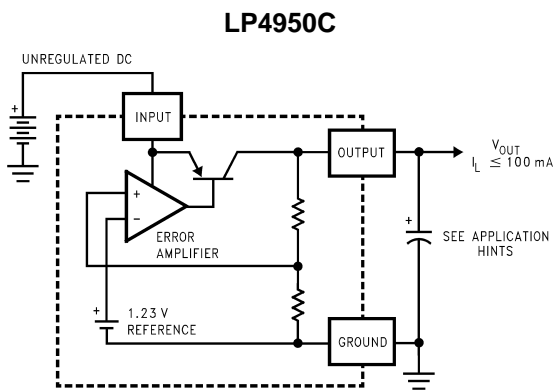

Figure 1.

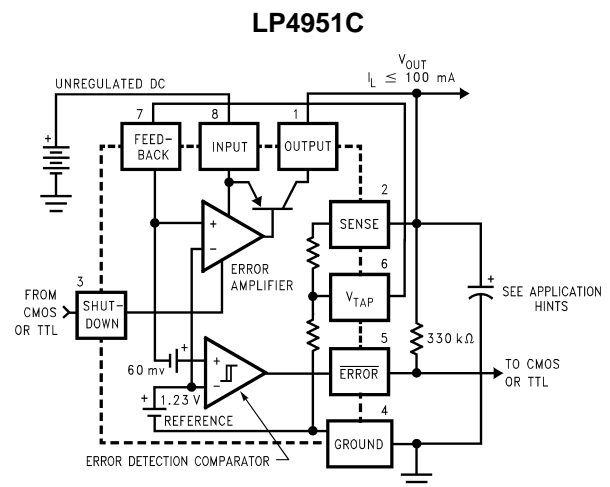

Figure 2.



Please be aware that an important notice concerning availability, standard warranty, and use in critical applications of Texas Instruments semiconductor products and disclaimers thereto appears at the end of this data sheet.

All trademarks are the property of their respective owners.



These devices have limited built-in ESD protection. The leads should be shorted together or the device placed in conductive foam during storage or handling to prevent electrostatic damage to the MOS gates.

ABSOLUTE MAXIMUM RATINGS ⁽¹⁾

Input Supply Voltage	-0.3 to +30V
SHUTDOWN Input Voltage, Error Comparator Output Voltage, ⁽²⁾	-0.3 to +30V
FEEDBACK Input Voltage ^{(2) (3)}	-1.5 to +30V
Power Dissipation	Internally Limited
Junction Temperature (T _J)	+150°C
Ambient Storage Temperature	-65° to +150°C
ESD Rating Human Body Model ⁽⁴⁾	2 kV
For soldering specifications, see the following document: www.ti.com/lit/snua549	

- (1) Absolute Maximum Ratings are limits beyond which damage to the device may occur. Operating Ratings are conditions under which operation of the device is specified. Operating Ratings do not imply specified performance limits. For specified performance limits and associated test conditions, see the Electrical Characteristics tables.
- (2) May exceed input supply voltage.
- (3) When used in dual-supply systems where the output terminal sees loads returned to a negative supply, the output voltage should be diode-clamped to ground.
- (4) Human Body Model 1.5 kΩ in series with 100 pF. LP4950 - passes 2 kV HBM. LP4951 - All pins pass 2 kV except Vfb -1000V.

OPERATING RATINGS ⁽¹⁾

Maximum Input Supply Voltage	30V
Junction Temperature Range ⁽²⁾	
LP4950C, LP4951C	-40°C to 125°C

- (1) Absolute Maximum Ratings are limits beyond which damage to the device may occur. Operating Ratings are conditions under which operation of the device is specified. Operating Ratings do not imply specified performance limits. For specified performance limits and associated test conditions, see the Electrical Characteristics tables.
- (2) The junction-to-ambient thermal resistances are as follows: 180°C/W and 160°C/W for the TO-92 package with 0.40 inch and 0.25 inch leads to the printed circuit board (PCB) respectively, 160°C/W for the molded plastic SOIC (D). The above thermal resistances for the SOIC package apply when the package is soldered directly to the PCB.

ELECTRICAL CHARACTERISTICS ⁽¹⁾

Parameter	Conditions (1)	LP4950CZ			Units
		LP4951CM			
			Tested	Design	
		Typ	Limit ⁽²⁾	Limit ⁽³⁾	
Output Voltage	$T_J = 25^\circ\text{C}$	5.0	5.1		V max
			4.9		V min
	Full Operating Temperature Range			5.15	V max
				4.85	V min
				5.2	V max
Output Voltage	$100\ \mu\text{A} \leq I_L \leq 100\ \text{mA}$ $T_J \leq T_{J\text{MAX}}$			4.8	V min
				5.24	V max
Output Voltage Temperature Coefficient	⁽⁴⁾			4.76	V min
Line Regulation ⁽⁵⁾	$6\text{V} \leq V_{\text{IN}} \leq 30\text{V}$ ⁽⁶⁾	0.04	0.2		% max
				0.4	% max
Load Regulation ⁽⁵⁾	$100\ \mu\text{A} \leq I_L \leq 100\ \text{mA}$	0.1	0.2		% max
				0.3	% max
Dropout Voltage ⁽⁷⁾	$I_L = 100\ \mu\text{A}$	50	80		mV max
				150	mV max
	$I_L = 100\ \text{mA}$	380	450		mV max
				600	mV max
Ground Current	$I_L = 100\ \mu\text{A}$	75	150		μA max
				170	μA max
	$I_L = 100\ \text{mA}$	8	15		mA max
				19	mA max
Dropout Ground Current	$V_{\text{IN}} = 4.5\text{V}$ $I_L = 100\ \mu\text{A}$	110	200		μA max
				230	μA max
Current Limit	$V_{\text{OUT}} = 0$	160	200		mA max
				220	mA max
Thermal Regulation	⁽⁸⁾	0.05	0.2		%/W max
Output Noise, 10 Hz to 100 kHz	$C_L = 1\ \mu\text{F}$	430			μV rms
	$C_L = 200\ \mu\text{F}$	160			μV rms
	$C_L = 3.3\ \mu\text{F}$ (Bypass = 0.01 μF Pins 7 to 1 (LP4951C))	100			μV rms

- (1) Unless otherwise noted all limits specified for $V_{\text{IN}} = 6\text{V}$, $I_L = 100\ \mu\text{A}$ and $C_L = 1\ \mu\text{F}$. Limits appearing in **boldface** type apply over the entire junction temperature range for operation. Limits appearing in normal type apply for $T_A = T_J = 25^\circ\text{C}$. Additional conditions for the 8-pin versions are FEEDBACK tied to V_{TAP} , OUTPUT tied to SENSE ($V_{\text{OUT}} = 5\text{V}$), and $V_{\text{SHUTDOWN}} \leq 0.8\text{V}$.
- (2) Specified and 100% production tested.
- (3) Specified but not 100% production tested. These limits are not used to calculate outgoing AQL levels.
- (4) Output or reference voltage temperature coefficient is defined as the worst case voltage change divided by the total temperature range.
- (5) Regulation is measured at constant junction temperature, using pulse testing with a low duty cycle. Changes in output voltage due to heating effects are covered under the specification for thermal regulation.
- (6) Line regulation for the LP4951C is tested at 150°C for $I_L = 1\ \text{mA}$. For $I_L = 100\ \mu\text{A}$ and $T_J = 125^\circ\text{C}$, line regulation is specified by design to 0.2%. See Typical Performance Characteristics for line regulation versus temperature and load current.
- (7) Dropout Voltage is defined as the input to output differential at which the output voltage drops 100 mV below its nominal value measured at 1V differential. At very low values of programmed output voltage, the minimum input supply voltage of 2V (2.3V over temperature) must be taken into account.
- (8) Thermal regulation is defined as the change in output voltage at a time T after a change in power dissipation is applied, excluding load or line regulation effects. Specifications are for a 50 mA load pulse at $V_{\text{IN}} = 30\text{V}$ (1.25W pulse) for $T = 10\text{ms}$.

ELECTRICAL CHARACTERISTICS

Parameter	Conditions ⁽¹⁾	LP4951C			Units
		Typ	Tested Limit ⁽²⁾	Design Limit ⁽³⁾	
8-PIN VERSIONS ONLY					
Reference Voltage		1.235	1.285		V max
				1.295	V max
			1.185		V min
				1.165	Vmin
Reference Voltage	⁽⁴⁾			1.335	V max
				1.135	V min
Feedback Pin Bias Current		20	40		nA max
				60	nA max
Reference Voltage Temperature Coefficient	⁽⁵⁾	50			ppm/°C
Feedback Pin Bias Current Temperature Coefficient		0.1			nA/°C
Error Comparator					
Output Leakage Current	VOH = 30V	0.01	1		µA max
				2	µA max
Output Low Voltage	VIN = 4.5V IOL = 400µA	150	250		mV max
				400	mV max
Upper Threshold Voltage	⁽³⁾	60	40		mV min
				25	mV min
Lower Threshold Voltage	⁽⁶⁾	75	95		mV max
				140	mV max
Hysteresis	⁽⁶⁾	15			mV
Shutdown Input					
Input Logic Voltage		1.3			V
	Low (Regulator ON)			0.7	V max
	High (Regulator OFF)			2.0	V min
Shutdown Pin Input Current	VSHUTDOWN = 2.4V	30	50		µA max
				100	µA max
	VSHUTDOWN = 30V	450	600		µA max
				750	µA max
Regulator Output Current in Shutdown	⁽⁷⁾	3	10		µA max
				20	µA max

- (1) Unless otherwise noted all limits specified for VIN = 6V, IL = 100µA and CL = 1µF. Limits appearing in **boldface** type apply over the entire junction temperature range for operation. Limits appearing in normal type apply for TA = TJ = 25°C. Additional conditions for the 8-pin versions are FEEDBACK tied to VTAP, OUTPUT tied to SENSE (VOUT = 5V), and VSHUTDOWN ≤ 0.8V.
- (2) Specified and 100% production tested.
- (3) Specified but not 100% production tested. These limits are not used to calculate outgoing AQL levels.
- (4) VREF ≤ VOUT ≤ (VIN - 1V), 2.3V ≤ VIN ≤ 30V, 100µA ≤ IL ≤ 100mA, TJ ≤ TJMAX.
- (5) Output or reference voltage temperature coefficient is defined as the worst case voltage change divided by the total temperature range.
- (6) Comparator thresholds are expressed in terms of a voltage differential at the Feedback terminal below the nominal reference voltage measured at VIN = 6V. To express these thresholds in terms of output voltage change, multiply by the error amplifier gain = VOUT/VREF = (R1 + R2)/R2. For example, at a programmed output voltage of 5V, the Error output is specified to go low when the output drops by 95 mV × 5V/1.235V = 384 mV. Thresholds remain constant as a percent of VOUT as VOUT is varied, with the dropout warning occurring at typically 5% below nominal, 7.5% specified.
- (7) VSHUTDOWN ≥ 2V, VIN ≤ 30V, VOUT = 0, Feedback pin tied to VTAP.

CONNECTION DIAGRAMS

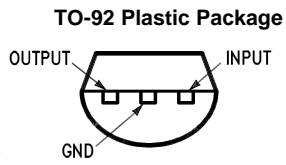

Figure 3. Bottom View

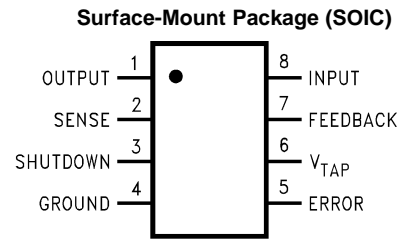

Figure 4. Top View

TYPICAL PERFORMANCE CHARACTERISTICS

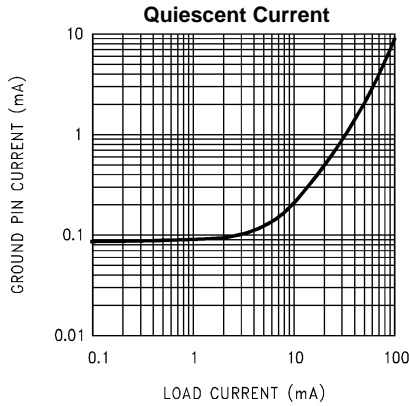

Figure 5.

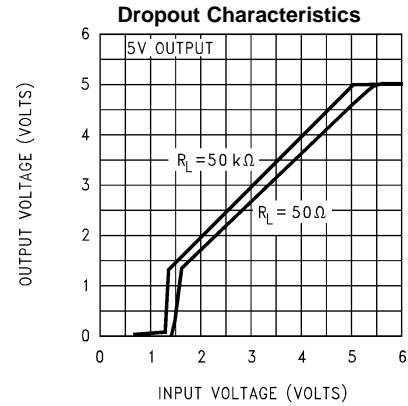

Figure 6.

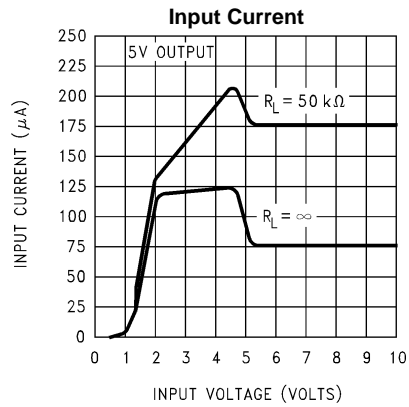

Figure 7.

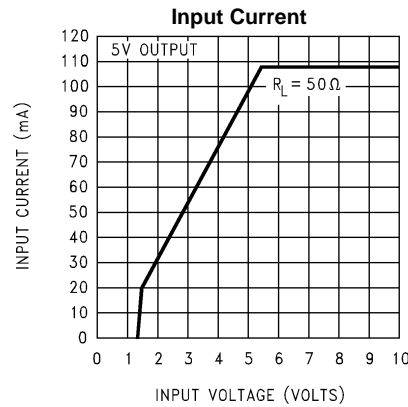

Figure 8.

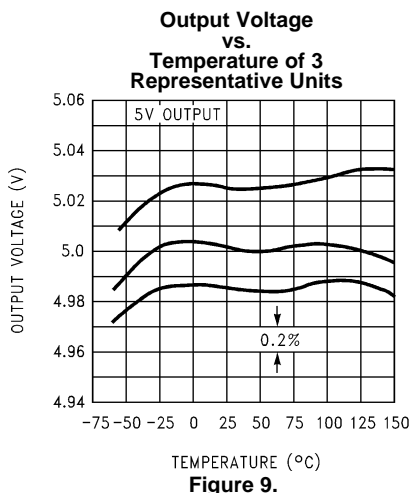

Figure 9.

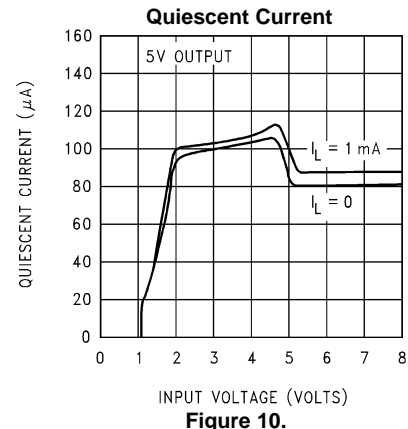

Figure 10.

TYPICAL PERFORMANCE CHARACTERISTICS (continued)

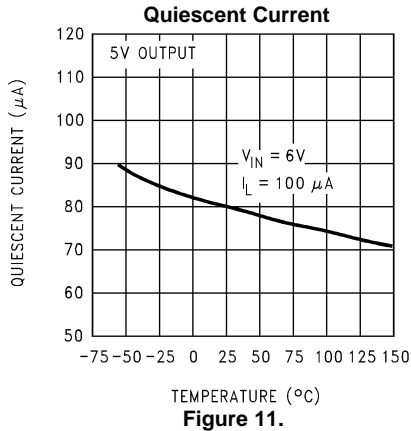

Figure 11.

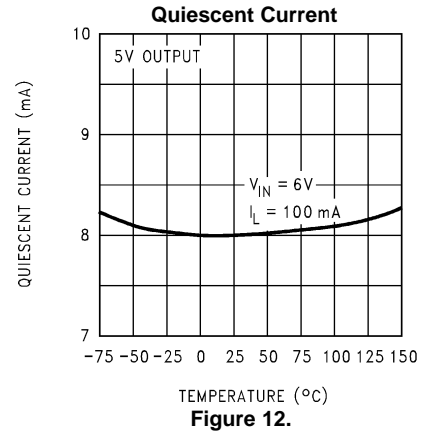

Figure 12.

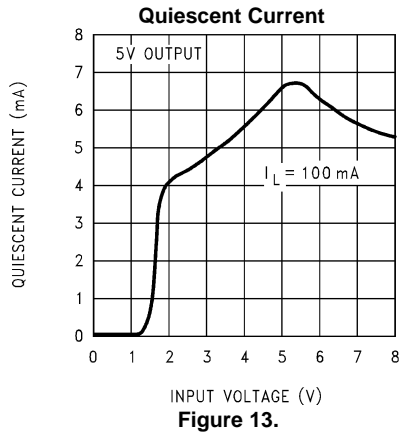

Figure 13.

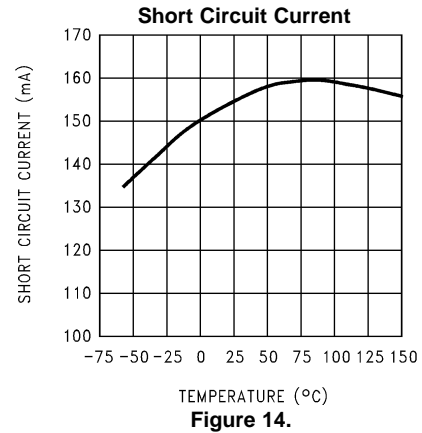

Figure 14.

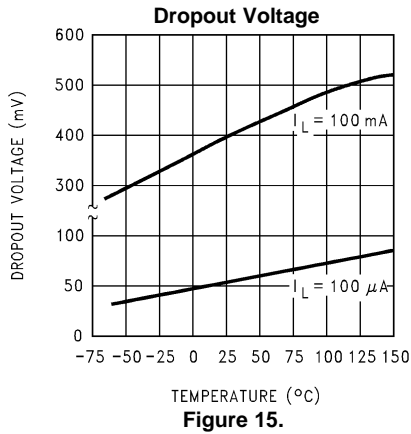

Figure 15.

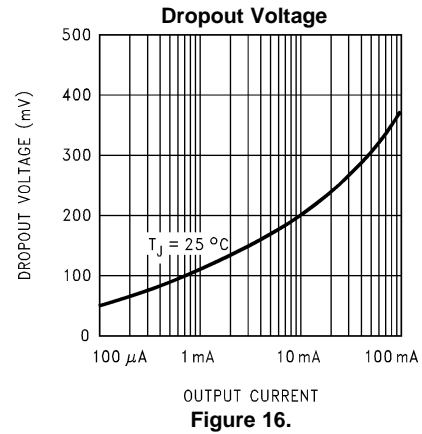
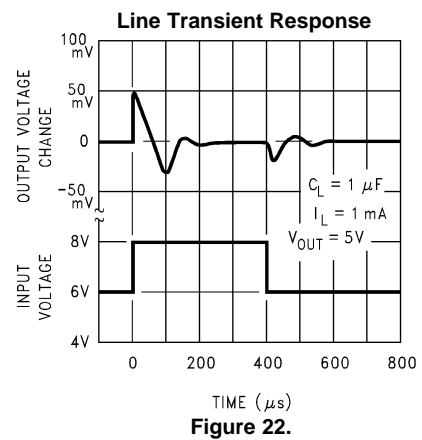
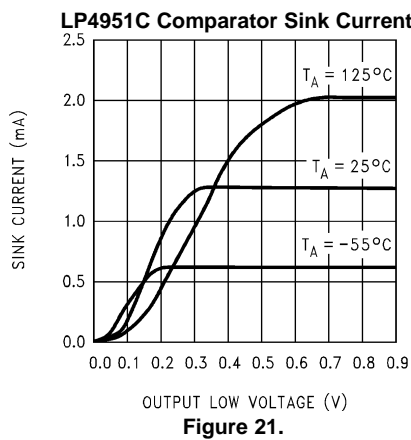
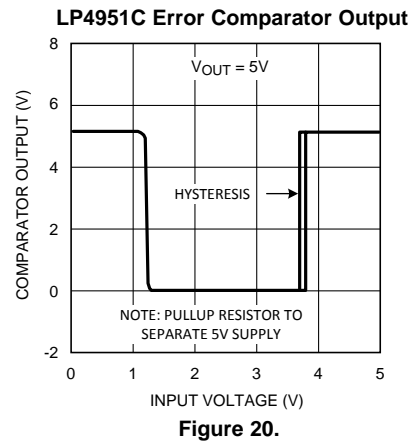
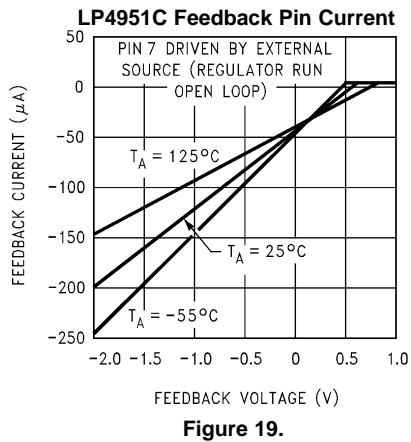
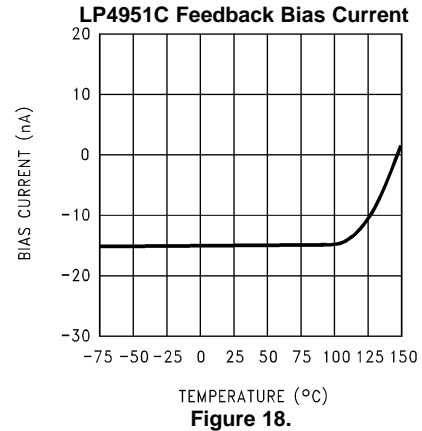
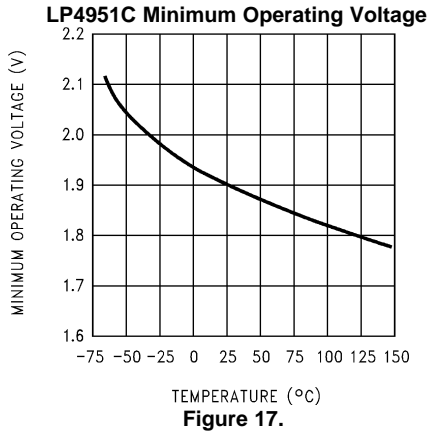

Figure 16.

TYPICAL PERFORMANCE CHARACTERISTICS (continued)



TYPICAL PERFORMANCE CHARACTERISTICS (continued)

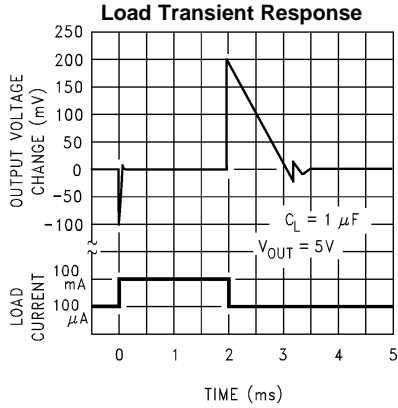

Figure 23.

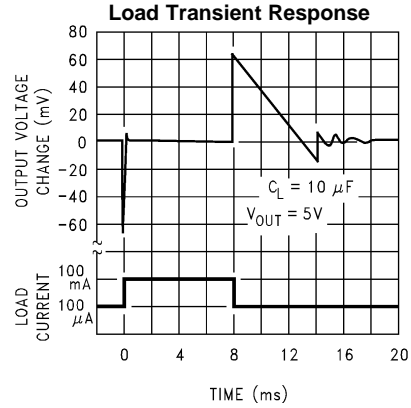

Figure 24.

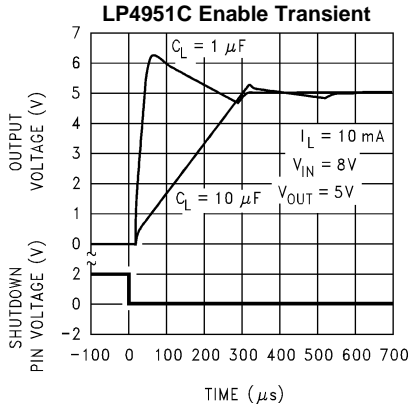

Figure 25.

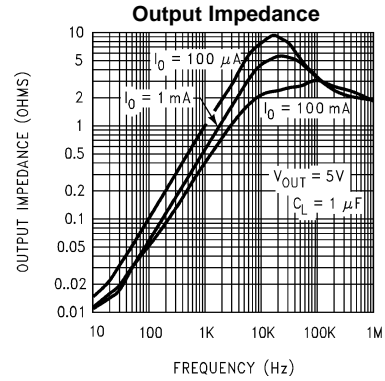

Figure 26.

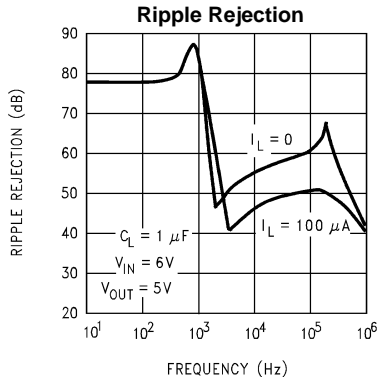

Figure 27.

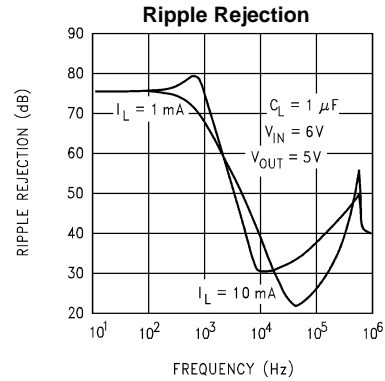

Figure 28.

TYPICAL PERFORMANCE CHARACTERISTICS (continued)

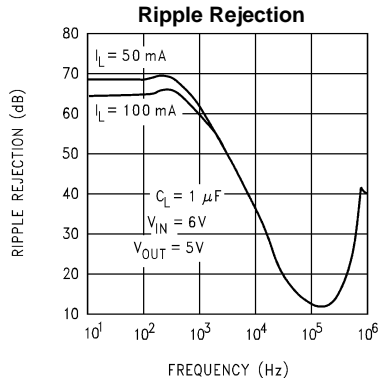

Figure 29.

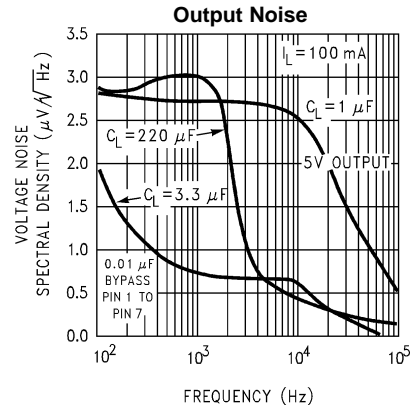

Figure 30.

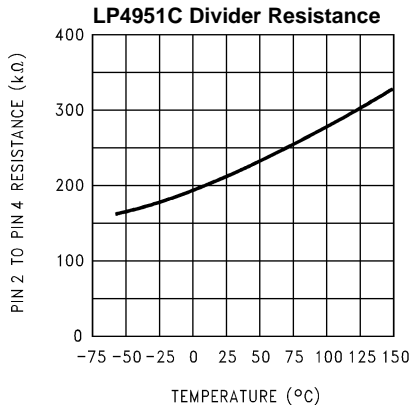

Figure 31.

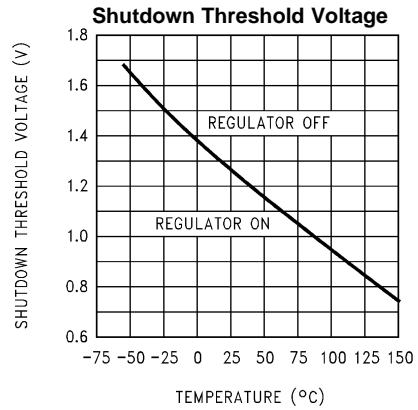

Figure 32.

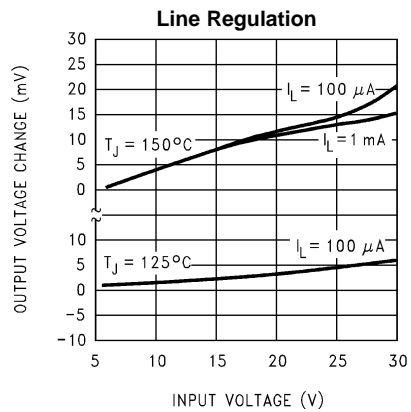

Figure 33.

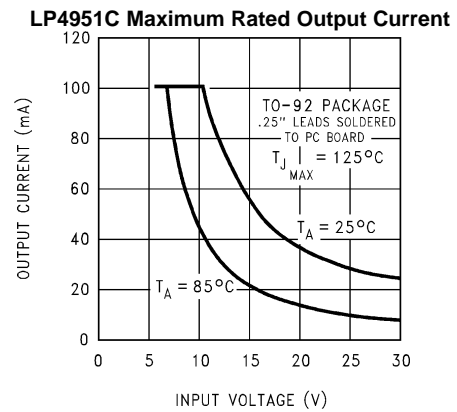

Figure 34.

TYPICAL PERFORMANCE CHARACTERISTICS (continued)

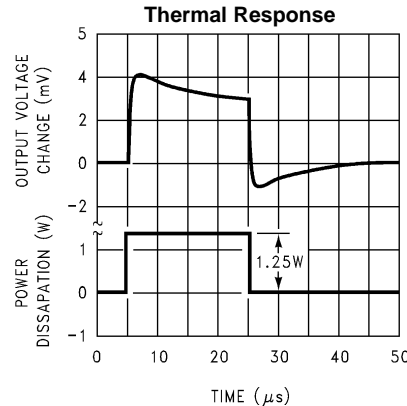

Figure 35.

APPLICATION HINTS

EXTERNAL CAPACITORS

A 1.0μF (or greater) capacitor is required between the output and ground for stability at output voltages of 5V or more. At lower output voltages, more capacitance is required. Without this capacitor the part will oscillate. Most types of tantalum or aluminum electrolytics work fine here; even film types work but are not recommended for reasons of cost. Many aluminum electrolytics have electrolytes that freeze at about -30°C , so solid tantalums are recommended for operation below -25°C . The important parameters of the capacitor are an ESR of about 5 Ω or less and a resonant frequency above 500 kHz. The value of this capacitor may be increased without limit.

At lower values of output current, less output capacitance is required for stability. The capacitor can be reduced to 0.33 μF for currents below 10 mA or 0.1 μF for currents below 1 mA. Using the 8-pin version at voltages below 5V runs the error amplifier at lower gains so that *more* output capacitance is needed. For the worst-case situation of a 100 mA load at 1.23V output (Output shorted to Feedback) a 3.3 μF (or greater) capacitor should be used.

Unlike many other regulators, the LP4950C will remain stable and in regulation with no load in addition to the internal voltage divider. This is especially important in CMOS RAM keep-alive applications. When setting the output voltage of the LP4951C version with external resistors, a minimum load of 1μA is recommended.

A 0.1μF capacitor should be placed from the LP4950C/LP4951C input to ground if there is more than 10 inches of wire between the input and the AC filter capacitor or if a battery is used as the input.

Stray capacitance to the LP4951C Feedback terminal (pin 7) can cause instability. This may especially be a problem when using high value external resistors to set the output voltage. Adding a 100pF capacitor between Output and Feedback and increasing the output capacitor to at least 3.3μF will fix this problem.

ERROR DETECTION COMPARATOR OUTPUT

The comparator produces a logic low output whenever the LP4951C output falls out of regulation by more than approximately 5%. This figure is the comparator's built-in offset of about 60 mV divided by the 1.235 reference voltage. (See to the block diagram in the front of the datasheet.) This trip level remains "5% below normal" regardless of the programmed output voltage of the 4951C. For example, the error flag trip level is typically 4.75V for a 5V output or 11.4V for a 12V output. The out of regulation condition may be due either to low input voltage, current limiting, or thermal limiting.

Figure 36 below gives a timing diagram depicting the $\overline{\text{ERROR}}$ signal and the regulated output voltage as the LP4951C input is ramped up and down. The $\overline{\text{ERROR}}$ signal becomes valid (low) at about 1.3V input. It goes high at about 5V input (the input voltage at which $V_{\text{OUT}} = 4.75\text{V}$). Since the LP4951C's dropout voltage is load-dependent (see curve in typical performance characteristics), the **input** voltage trip point (about 5V) will vary with the load current. The **output** voltage trip point (approx. 4.75V) does not vary with load.

The error comparator has an open-collector output which requires an external pullup resistor. This resistor may be returned to the output or some other supply voltage depending on system requirements. In determining a value for this resistor, note that while the output is rated to sink 400µA, this sink current adds to battery drain in a low battery condition. Suggested values range from 100k to 1 MΩ. The resistor is not required if this output is unused.

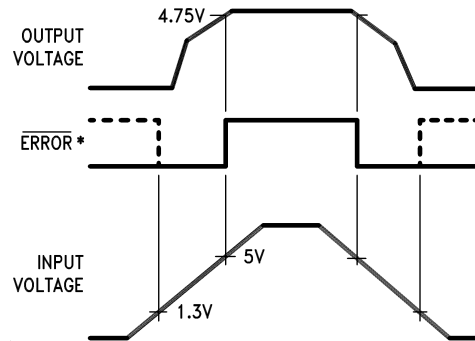

*When $V_{IN} \leq 1.3V$, the error flag pin becomes a high impedance, and the error flag voltage rises to its pull-up voltage. Using V_{OUT} as the pull-up voltage (see Figure 37), rather than an external 5V source, will keep the error flag voltage under 1.2V (typ.) in this condition. The user may wish to divide down the error flag voltage using equal-value resistors (10 kΩ suggested), to ensure a low-level logic signal during any fault condition, while still allowing a valid high logic level during normal operation.

Figure 36. $\overline{\text{ERROR}}$ Output Timing

PROGRAMMING THE OUTPUT VOLTAGE (LP4951C)

The LP4951C may be pin-strapped for 5V using its internal voltage divider by tying the pin 1 (output) to pin 2 (sense) pins together, and also tying the pin 7 (feedback) and pin 6 (V_{TAP}) pins together. Alternatively, it may be programmed for any output voltage between its 1.235V reference and its 30V maximum rating. As seen in Figure 37, an external pair of resistors is required.

The complete equation for the output voltage is

$$V_{OUT} = V_{REF} \cdot \left(1 + \frac{R_1}{R_2} \right) + I_{FB}R_1 \quad (1)$$

where V_{REF} is the nominal 1.235 reference voltage and I_{FB} is the feedback pin bias current, nominally -20 nA. The minimum recommended load current of $1\mu\text{A}$ forces an upper limit of 1.2 MΩ on the value of R_2 , if the regulator must work with no load (a condition often found in CMOS in standby). I_{FB} will produce a 2% typical error in V_{OUT} which may be eliminated at room temperature by trimming R_1 . For better accuracy, choosing $R_2 = 100\text{k}$ reduces this error to 0.17% while increasing the resistor program current to $12\mu\text{A}$. Since the LP4951C typically draws $60\mu\text{A}$ at no load with Pin 2 open-circuited, this is a small price to pay.

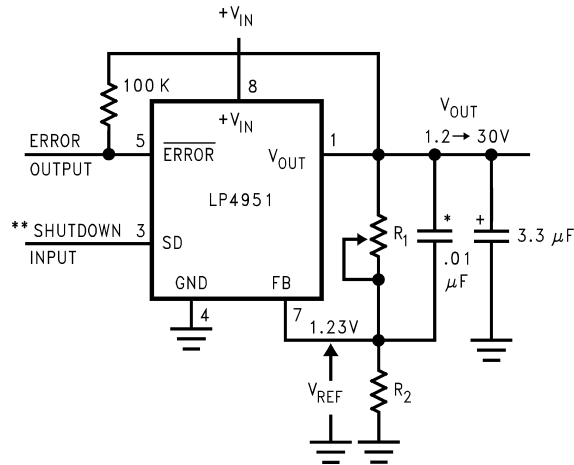

*See Application Hints

$$V_{out} = V_{Ref} \left(1 + \frac{R_1}{R_2} \right)$$

**Drive with TTL-high to shut down. Ground or leave open if shutdown feature is not to be used.

Note: Pins 2 and 6 are left open.

Figure 37. Adjustable Regulator (LP4951C)

REDUCING OUTPUT NOISE

In reference applications it may be advantageous to reduce the AC noise present at the output. One method is to reduce the regulator bandwidth by increasing the size of the output capacitor. This is the only way noise can be reduced on the 3 lead LP4950C but is relatively inefficient, as increasing the capacitor from 1μF to 220μF only decreases the noise from 430μV to 160μV rms for a 100kHz bandwidth at 5V output.

Noise can be reduced fourfold by a bypass capacitor across R_1 , since it reduces the high frequency gain from 4 to unity. Pick

$$C_{BYPASS} \cong \frac{1}{2\pi R_1 \bullet 200 \text{ Hz}} \quad (2)$$

or about 0.01μF. When doing this, the output capacitor must be increased to 3.3μF to maintain stability. These changes reduce the output noise from 430μV to 100μV rms for a 100kHz bandwidth at 5V output. With the bypass capacitor added, noise no longer scales with output voltage so that improvements are more dramatic at higher output voltages.

SCHEMATIC DIAGRAM

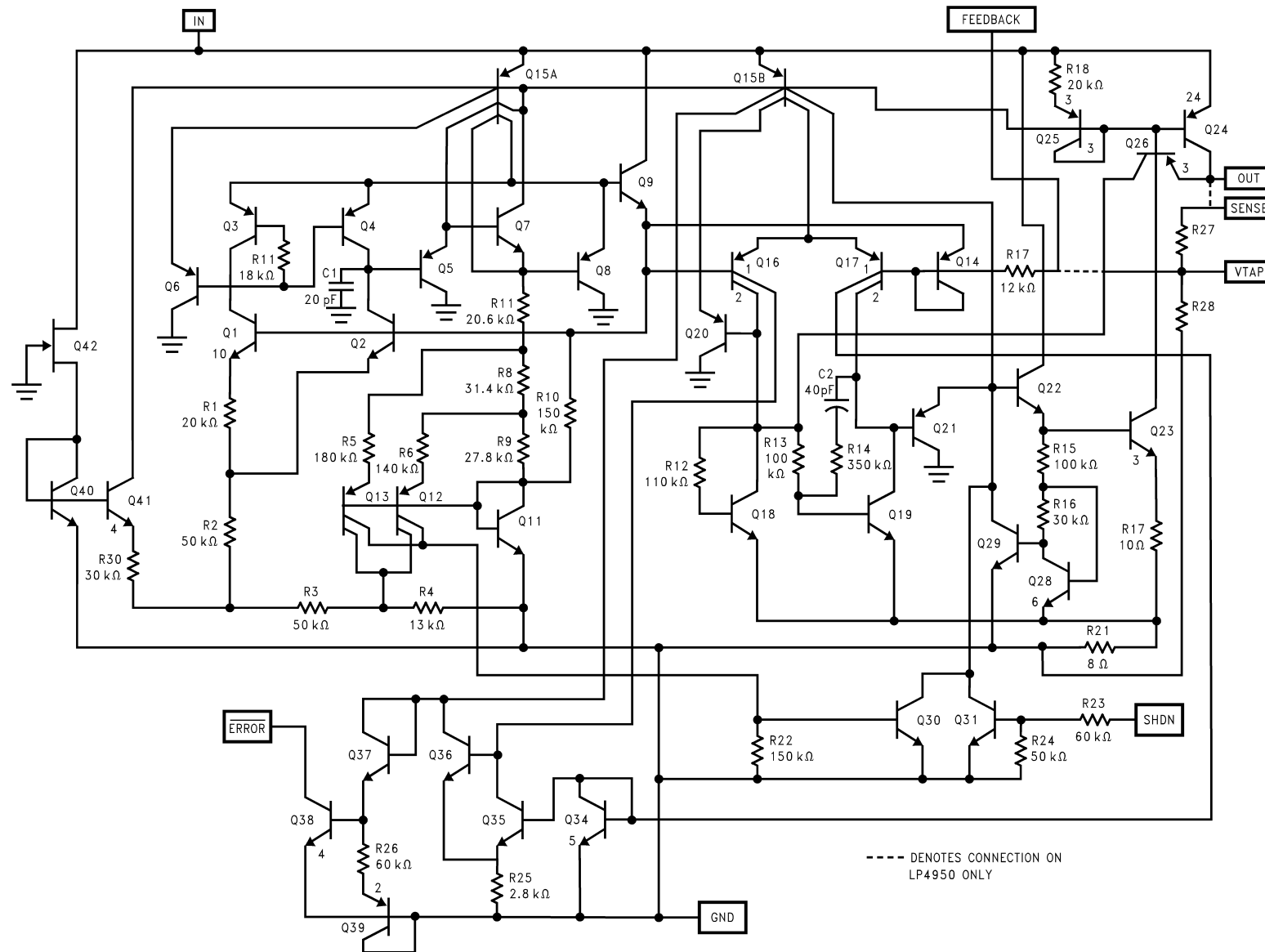

REVISION HISTORY

Changes from Revision B (April 2013) to Revision C	Page
• Changed layout of National Data Sheet to TI format	14

PACKAGING INFORMATION

Orderable Device	Status (1)	Package Type	Package Drawing	Pins	Package Qty	Eco Plan (2)	Lead/Ball Finish (6)	MSL Peak Temp (3)	Op Temp (°C)	Device Marking (4/5)	Samples
LP4951CM/NOPB	ACTIVE	SOIC	D	8	95	Green (RoHS & no Sb/Br)	CU SN	Level-1-260C-UNLIM	-40 to 125	LP495 1CM	Samples
LP4951CMX/NOPB	ACTIVE	SOIC	D	8	2500	Green (RoHS & no Sb/Br)	CU SN	Level-1-260C-UNLIM	-40 to 125	LP495 1CM	Samples

(1) The marketing status values are defined as follows:

ACTIVE: Product device recommended for new designs.

LIFEBUY: TI has announced that the device will be discontinued, and a lifetime-buy period is in effect.

NRND: Not recommended for new designs. Device is in production to support existing customers, but TI does not recommend using this part in a new design.

PREVIEW: Device has been announced but is not in production. Samples may or may not be available.

OBSELETE: TI has discontinued the production of the device.

(2) Eco Plan - The planned eco-friendly classification: Pb-Free (RoHS), Pb-Free (RoHS Exempt), or Green (RoHS & no Sb/Br) - please check <http://www.ti.com/productcontent> for the latest availability information and additional product content details.

TBD: The Pb-Free/Green conversion plan has not been defined.

Pb-Free (RoHS): TI's terms "Lead-Free" or "Pb-Free" mean semiconductor products that are compatible with the current RoHS requirements for all 6 substances, including the requirement that lead not exceed 0.1% by weight in homogeneous materials. Where designed to be soldered at high temperatures, TI Pb-Free products are suitable for use in specified lead-free processes.

Pb-Free (RoHS Exempt): This component has a RoHS exemption for either 1) lead-based flip-chip solder bumps used between the die and package, or 2) lead-based die adhesive used between the die and leadframe. The component is otherwise considered Pb-Free (RoHS compatible) as defined above.

Green (RoHS & no Sb/Br): TI defines "Green" to mean Pb-Free (RoHS compatible), and free of Bromine (Br) and Antimony (Sb) based flame retardants (Br or Sb do not exceed 0.1% by weight in homogeneous material)

(3) MSL, Peak Temp. - The Moisture Sensitivity Level rating according to the JEDEC industry standard classifications, and peak solder temperature.

(4) There may be additional marking, which relates to the logo, the lot trace code information, or the environmental category on the device.

(5) Multiple Device Markings will be inside parentheses. Only one Device Marking contained in parentheses and separated by a "~" will appear on a device. If a line is indented then it is a continuation of the previous line and the two combined represent the entire Device Marking for that device.

(6) Lead/Ball Finish - Orderable Devices may have multiple material finish options. Finish options are separated by a vertical ruled line. Lead/Ball Finish values may wrap to two lines if the finish value exceeds the maximum column width.

Important Information and Disclaimer: The information provided on this page represents TI's knowledge and belief as of the date that it is provided. TI bases its knowledge and belief on information provided by third parties, and makes no representation or warranty as to the accuracy of such information. Efforts are underway to better integrate information from third parties. TI has taken and continues to take reasonable steps to provide representative and accurate information but may not have conducted destructive testing or chemical analysis on incoming materials and chemicals. TI and TI suppliers consider certain information to be proprietary, and thus CAS numbers and other limited information may not be available for release.

In no event shall TI's liability arising out of such information exceed the total purchase price of the TI part(s) at issue in this document sold by TI to Customer on an annual basis.

TAPE AND REEL INFORMATION



QUADRANT ASSIGNMENTS FOR PIN 1 ORIENTATION IN TAPE



*All dimensions are nominal

Device	Package Type	Package Drawing	Pins	SPQ	Reel Diameter (mm)	Reel Width W1 (mm)	A0 (mm)	B0 (mm)	K0 (mm)	P1 (mm)	W (mm)	Pin1 Quadrant
LP4951CMX/NOPB	SOIC	D	8	2500	330.0	12.4	6.5	5.4	2.0	8.0	12.0	Q1

TAPE AND REEL BOX DIMENSIONS



*All dimensions are nominal

Device	Package Type	Package Drawing	Pins	SPQ	Length (mm)	Width (mm)	Height (mm)
LP4951CMX/NOPB	SOIC	D	8	2500	367.0	367.0	35.0

D (R-PDSO-G8)

PLASTIC SMALL OUTLINE



NOTES: A. All linear dimensions are in inches (millimeters).
 B. This drawing is subject to change without notice.
 C. Body length does not include mold flash, protrusions, or gate burrs. Mold flash, protrusions, or gate burrs shall not exceed 0.006 (0,15) each side.
 D. Body width does not include interlead flash. Interlead flash shall not exceed 0.017 (0,43) each side.
 E. Reference JEDEC MS-012 variation AA.

IMPORTANT NOTICE

Texas Instruments Incorporated and its subsidiaries (TI) reserve the right to make corrections, enhancements, improvements and other changes to its semiconductor products and services per JESD46, latest issue, and to discontinue any product or service per JESD48, latest issue. Buyers should obtain the latest relevant information before placing orders and should verify that such information is current and complete. All semiconductor products (also referred to herein as "components") are sold subject to TI's terms and conditions of sale supplied at the time of order acknowledgment.

TI warrants performance of its components to the specifications applicable at the time of sale, in accordance with the warranty in TI's terms and conditions of sale of semiconductor products. Testing and other quality control techniques are used to the extent TI deems necessary to support this warranty. Except where mandated by applicable law, testing of all parameters of each component is not necessarily performed.

TI assumes no liability for applications assistance or the design of Buyers' products. Buyers are responsible for their products and applications using TI components. To minimize the risks associated with Buyers' products and applications, Buyers should provide adequate design and operating safeguards.

TI does not warrant or represent that any license, either express or implied, is granted under any patent right, copyright, mask work right, or other intellectual property right relating to any combination, machine, or process in which TI components or services are used. Information published by TI regarding third-party products or services does not constitute a license to use such products or services or a warranty or endorsement thereof. Use of such information may require a license from a third party under the patents or other intellectual property of the third party, or a license from TI under the patents or other intellectual property of TI.

Reproduction of significant portions of TI information in TI data books or data sheets is permissible only if reproduction is without alteration and is accompanied by all associated warranties, conditions, limitations, and notices. TI is not responsible or liable for such altered documentation. Information of third parties may be subject to additional restrictions.

Resale of TI components or services with statements different from or beyond the parameters stated by TI for that component or service voids all express and any implied warranties for the associated TI component or service and is an unfair and deceptive business practice. TI is not responsible or liable for any such statements.

Buyer acknowledges and agrees that it is solely responsible for compliance with all legal, regulatory and safety-related requirements concerning its products, and any use of TI components in its applications, notwithstanding any applications-related information or support that may be provided by TI. Buyer represents and agrees that it has all the necessary expertise to create and implement safeguards which anticipate dangerous consequences of failures, monitor failures and their consequences, lessen the likelihood of failures that might cause harm and take appropriate remedial actions. Buyer will fully indemnify TI and its representatives against any damages arising out of the use of any TI components in safety-critical applications.

In some cases, TI components may be promoted specifically to facilitate safety-related applications. With such components, TI's goal is to help enable customers to design and create their own end-product solutions that meet applicable functional safety standards and requirements. Nonetheless, such components are subject to these terms.

No TI components are authorized for use in FDA Class III (or similar life-critical medical equipment) unless authorized officers of the parties have executed a special agreement specifically governing such use.

Only those TI components which TI has specifically designated as military grade or "enhanced plastic" are designed and intended for use in military/aerospace applications or environments. Buyer acknowledges and agrees that any military or aerospace use of TI components which have **not** been so designated is solely at the Buyer's risk, and that Buyer is solely responsible for compliance with all legal and regulatory requirements in connection with such use.

TI has specifically designated certain components as meeting ISO/TS16949 requirements, mainly for automotive use. In any case of use of non-designated products, TI will not be responsible for any failure to meet ISO/TS16949.

Products

Audio	www.ti.com/audio
Amplifiers	amplifier.ti.com
Data Converters	dataconverter.ti.com
DLP® Products	www.dlp.com
DSP	dsp.ti.com
Clocks and Timers	www.ti.com/clocks
Interface	interface.ti.com
Logic	logic.ti.com
Power Mgmt	power.ti.com
Microcontrollers	microcontroller.ti.com
RFID	www.ti-rfid.com
OMAP Applications Processors	www.ti.com/omap
Wireless Connectivity	www.ti.com/wirelessconnectivity

Applications

Automotive and Transportation	www.ti.com/automotive
Communications and Telecom	www.ti.com/communications
Computers and Peripherals	www.ti.com/computers
Consumer Electronics	www.ti.com/consumer-apps
Energy and Lighting	www.ti.com/energy
Industrial	www.ti.com/industrial
Medical	www.ti.com/medical
Security	www.ti.com/security
Space, Avionics and Defense	www.ti.com/space-avionics-defense
Video and Imaging	www.ti.com/video

TI E2E Community

e2e.ti.com