

LMV60x 1-MHz, Low-Power, General-Purpose, 2.7-V Operational Amplifiers

1 Features

- Typical 2.7-V Supply Values; Unless Otherwise Noted
- Ensured 2.7-V and 5-V Specifications
- Supply Current (Per Amplifier): 100 μ A
- Gain Bandwidth Product: 1 MHz
- Shutdown Current (LMV601): 45 pA
- Turnon Time from Shutdown (LMV601): 5 μ s
- Input Bias Current: 20 fA

2 Applications

- Cordless and Cellular Phones
- Laptops
- PDAs
- PCMCIA and Audio
- Portable and Battery-Powered Electronic Equipment
- Supply Current Monitoring
- Battery Monitoring
- Buffers
- Filters
- Drivers

3 Description

The LMV60x devices are single, dual, and quad low-voltage, low-power operational amplifiers. They are designed specifically for low-voltage, general-purpose applications. Other important product characteristics are low input bias current, rail-to-rail output, and wide temperature range. The LMV60x have 29-nV voltage noise at 10 KHz, 1-MHz GBW, 1-V/ μ s slew rate, 0.25-mV V_{os} . The LMV60x operates from a single supply voltage as low as 2.7 V, while drawing 100- μ A (typical) quiescent current. In shutdown mode, the current can be reduced to 45 pA.

The industrial-plus temperature range of -40°C to 125°C allows the LMV60x to accommodate a broad range of extended environment applications.

The LMV601 offers a shutdown pin that can be used to disable the device. Once in shutdown mode, the supply current is reduced to 45 pA (typical).

The LMV601 is offered in the tiny 6-pin SC70 package, the LMV602 in space-saving 8-pin VSSOP and SOIC, and the LMV604 in 14-pin TSSOP and SOIC. These small package amplifiers offer an ideal solution for applications requiring minimum PCB footprint. Applications with area constrained printed-circuit board requirements include portable and battery-operated electronics.

Device Information⁽¹⁾

PART NUMBER	PACKAGE	BODY SIZE (NOM)
LMV601	SC70 (6)	2.00 mm \times 1.25 mm
LMV602	SOIC (8)	4.90 mm \times 3.91 mm
	VSSOP (8)	3.00 mm \times 3.00 mm
LMV604	SOIC (8)	4.90 mm \times 3.91 mm
	TSSOP (14)	5.00 mm \times 4.40 mm

(1) For all available packages, see the orderable addendum at the end of the data sheet.

Sample and Hold Circuit

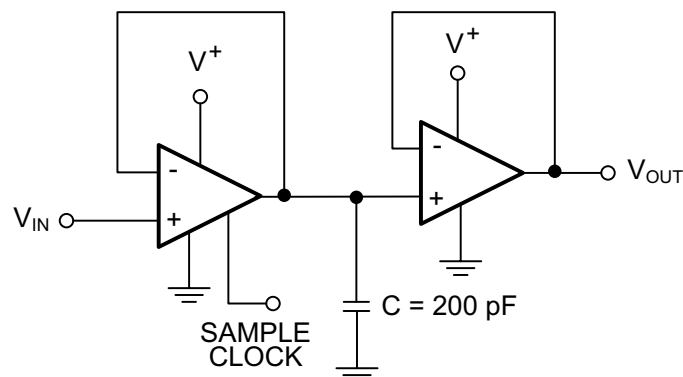

Copyright © 2016, Texas Instruments Incorporated



Table of Contents

1 Features	1	7.4 Device Functional Modes.....	15
2 Applications	1	8 Application and Implementation	18
3 Description	1	8.1 Application Information.....	18
4 Revision History	2	8.2 Typical Application	18
5 Pin Configuration and Functions	3	8.3 Dos and Don'ts.....	19
6 Specifications	5	9 Power Supply Recommendations	19
6.1 Absolute Maximum Ratings	5	10 Layout	20
6.2 ESD Ratings.....	5	10.1 Layout Guideline	20
6.3 Recommended Operating Conditions.....	5	10.2 Layout Example	20
6.4 Thermal Information	5	11 Device and Documentation Support	21
6.5 Electrical Characteristics – DC (2.7 V)	6	11.1 Device Support.....	21
6.6 Electrical Characteristics – AC (2.7 V).....	6	11.2 Documentation Support	21
6.7 Electrical Characteristics – DC (5 V)	7	11.3 Related Links	21
6.8 Electrical Characteristics – AC (5 V).....	7	11.4 Receiving Notification of Documentation Updates	21
6.9 Typical Characteristics.....	8	11.5 Community Resources.....	21
7 Detailed Description	15	11.6 Trademarks	21
7.1 Overview	15	11.7 Electrostatic Discharge Caution.....	22
7.2 Functional Block Diagram	15	11.8 Glossary	22
7.3 Feature Description.....	15	12 Mechanical, Packaging, and Orderable Information	22

4 Revision History

NOTE: Page numbers for previous revisions may differ from page numbers in the current version.

Changes from Revision B (March 2013) to Revision C

Page

• Added ESD Ratings table, Feature Description section, Device Functional Modes, Application and Implementation section, Power Supply Recommendations section, Layout section, Device and Documentation Support section, and Mechanical, Packaging, and Orderable Information section	1
• Changed Thermal Information table to align with JEDEC standards	5
• Changed ON mode (LMV601) typical value for V_{SD} in <i>Electrical Characteristics – DC (2.7 V)</i> from '1.7 to 2.7' to '1.7'.....	6
• Changed ON Mode (LMV601) max value for V_{SD} in <i>Electrical Characteristics – DC (2.7 V)</i> from '2.4 to 2.7' to '2.7'	6
• Changed Shutdown mode (LMV601) typical value for V_{SD} in <i>Electrical Characteristics – DC (2.7 V)</i> from '0 to 1' to '0'	6
• Changed Shutdown mode (LMV601) max value for V_{SD} in <i>Electrical Characteristics – DC (2.7 V)</i> from '0 to 0.8' to '0.8' ...	6
• Deleted '-0.2 to 4.2 (Range)' from V_{CM} in <i>Electrical Characteristics – DC (5 V)</i>	7
• Changed ON mode (LMV601) typical value for V_{SD} in <i>Electrical Characteristics – DC (5 V)</i> from '3.1 to 5' to '3.1'.....	7
• Changed ON mode (LMV601) max value for V_{SD} in <i>Electrical Characteristics – DC (5 V)</i> from '4.5 to 5' to '5'	7
• Changed Shutdown mode (LMV601) typical value for V_{SD} in <i>Electrical Characteristics – DC (5 V)</i> from '0 to 1' to '1'	7
• Changed Shutdown mode (LMV601) max value for V_{SD} in <i>Electrical Characteristics – DC (5 V)</i> from '0 to 0.8' to '0.8'	7

Changes from Revision A (March 2012) to Revision B

Page

• Changed layout of National Data Sheet to TI format	16
--	-----------

5 Pin Configuration and Functions

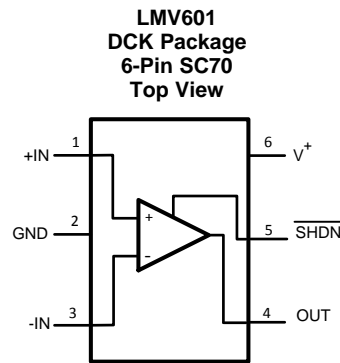

Pin Functions: LMV601

PIN		I/O	DESCRIPTION
NAME	NO.		
GND	2	P	Supply negative input
+IN	1	I	Noninverting input
-IN	3	I	Inverting input
OUT	4	O	Output
SHDN	5	I	Active low enable input
V+	6	P	Positive supply input

LMV601, LMV602, LMV604

SNOSC70C – APRIL 2012 – REVISED JULY 2016

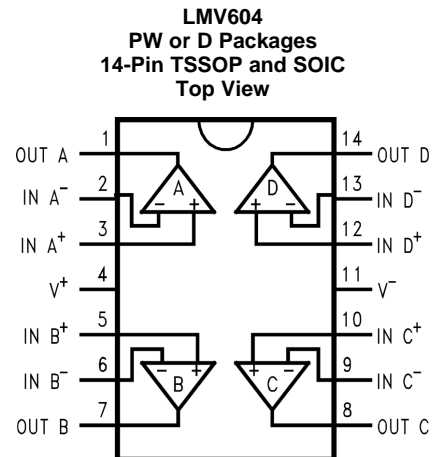
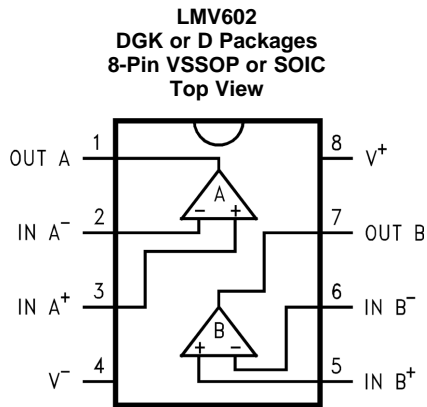
www.ti.com

Pin Functions: LMV602, LMV604

NAME	PIN		I/O	DESCRIPTION
	NO.			
	LMV602	LMV604		
+INA	3	3	I	Noninverting input, channel A
+INB	5	5	I	Noninverting input, channel B
+INC	—	10	I	Noninverting input, channel C
+IND	—	12	I	Noninverting input, channel D
–INA	2	2	I	Inverting input, channel A
–INB	6	6	I	Inverting input, channel B
–INC	—	9	I	Inverting input, channel C
–IND	—	13	I	Inverting input, channel D
OUTA	1	1	O	Output, channel A
OUTB	7	7	O	Output, channel B
OUTC	—	8	O	Output, channel C
OUTD	—	14	O	Output, channel D
V+	8	4	P	Positive (highest) power supply
V–	4	11	P	Negative (lowest) power supply

6 Specifications

6.1 Absolute Maximum Ratings

over operating free-air temperature range (unless otherwise noted)⁽¹⁾⁽²⁾

	MIN	MAX	UNIT
Differential input voltage	±Supply Voltage		
Supply voltage, (V+) – (V–)	6		V
Output short circuit to V+	See ⁽³⁾		
Output short circuit to V–	See ⁽⁴⁾		
Junction temperature, T _J ⁽⁵⁾	150		°C
Storage temperature, T _{stg}	–65	150	°C

- (1) Stresses beyond those listed under *Absolute Maximum Ratings* may cause permanent damage to the device. These are stress ratings only, which do not imply functional operation of the device at these or any other conditions beyond those indicated under *Recommended Operating Conditions*. Exposure to absolute-maximum-rated conditions for extended periods may affect device reliability.
- (2) If Military/Aerospace specified devices are required, please contact the Texas Instruments Sales Office/Distributors for availability and specifications.
- (3) Shorting output to V+ adversely affects reliability.
- (4) Shorting output to V– adversely affects reliability.
- (5) The maximum power dissipation is a function of T_{J(MAX)}, R_{θJA}. The maximum allowable power dissipation at any ambient temperature is P_D = (T_{J(MAX)} – T_A) / R_{θJA}. All numbers apply for packages soldered directly onto a PCB.

6.2 ESD Ratings

		VALUE	UNIT
V _(ESD) Electrostatic discharge	Human-body model (HBM) ⁽¹⁾⁽¹⁾	±2000	V
	Machine model (MM) ⁽²⁾	±200	

- (1) Human-Body Model, applicable std. MIL-STD-883, Method 3015.7.
- (2) Machine Model, applicable std. JESD22-A115-A (ESD MM std. of JEDEC) Field-Induced Charge-Device Model, applicable std. JESD22-C101-C (ESD FICDM std. of JEDEC).

6.3 Recommended Operating Conditions

over operating free-air temperature range (unless otherwise noted)

	MIN	MAX	UNIT
Supply voltage	2.7	5.5	V
Temperature	–40	125	°C

6.4 Thermal Information

THERMAL METRIC ⁽¹⁾	LMV601		LMV602		LMV604		UNIT
	DCK (SC70)	D (SOIC)	DGK (VSSOP)	D (SOIC)	PW (TSSOP)		
	6 PINS	8 PINS	8 PINS	14 PINS	14 PINS		
R _{θJA} Junction-to-ambient thermal resistance	229.1	120.8	178.3	91.5	123.8		°C/W
R _{θJC(top)} Junction-to-case (top) thermal resistance	116.1	65.2	68.4	49.7	50.5		°C/W
R _{θJB} Junction-to-board thermal resistance	53.3	61.4	98.8	46	66.2		°C/W
Ψ _{JT} Junction-to-top characterization parameter	8.8	16.1	9.8	12.4	6.3		°C/W
Ψ _{JB} Junction-to-board characterization parameter	52.7	60.8	97.3	45.7	65.6		°C/W

- (1) For more information about traditional and new thermal metrics, see the [Semiconductor and IC Package Thermal Metrics](#) application report.

6.5 Electrical Characteristics – DC (2.7 V)

Unless otherwise specified, all limits ensured for $T_J = 25^\circ\text{C}$, $V^+ = 2.7\text{ V}$, $V^- = 0\text{ V}$, $V_{CM} = V^+ / 2$, $V_O = V^+ / 2$ and $R_L > 1\text{ M}\Omega$.⁽¹⁾

PARAMETER		TEST CONDITIONS		MIN	TYP	MAX	UNIT
V_{OS}	Input offset voltage	LMV601			0.25	4	mV
		LMV602 and LMV604			0.55	5	
TCV_{OS}	Input offset voltage average drift				1.7		$\mu\text{V}/^\circ\text{C}$
I_B	Input bias current				0.02		μA
I_{OS}	Input offset current				6.6		fA
I_S	Supply current	Per amplifier			100	170	μA
		Shutdown mode, $V_{SD} = 0\text{ V}$ (LMV601)			45 pA	1	μA
CMRR	Common-mode rejection ratio	$0\text{ V} \leq V_{CM} \leq 1.7\text{ V}$			80		dB
PSRR	Power supply rejection ratio	$2.7\text{ V} \leq V^+ \leq 5\text{ V}$			82		dB
V_{CM}	Input common-mode voltage	For CMRR $\geq 50\text{ dB}$		0		1.7	V
A_V	Large signal voltage gain	$R_L = 10\text{ k}\Omega$ to 1.35 V			113		dB
V_O	Output swing	$R_L = 10\text{ k}\Omega$ to 1.35 V	Swing high		5	30	mV
			Swing low		30	5.3	
I_O	Output short-circuit current	Sourcing LMV601 and LMV602			32		mA
		Sourcing LMV604			24		
		Sinking			24		
t_{on}	Turnon time from shutdown	(LMV601)			5		μs
V_{SD}	Shutdown pin voltage range	ON mode (LMV601)			1.7	2.7	V
		Shutdown mode (LMV601)			0	0.8	

(1) Values apply only for factory testing conditions at the temperature indicated. Factory testing conditions result in very limited self-heating of the device such that $T_J = T_A$. No assurance of parametric performance is indicated in the electrical tables under conditions of internal self heating where $T_J > T_A$.

6.6 Electrical Characteristics – AC (2.7 V)

Unless otherwise specified, all limits ensured for $T_J = 25^\circ\text{C}$, $V^+ = 2.7\text{ V}$, $V^- = 0\text{ V}$, $V_{CM} = V^+ / 2$, $V_O = V^+ / 2$ and $R_L > 1\text{ M}\Omega$.⁽¹⁾

PARAMETER		TEST CONDITIONS		MIN	TYP	MAX	UNIT
SR	Slew rate	$R_L = 10\text{ k}\Omega$, ⁽²⁾			1		$\text{V}/\mu\text{s}$
GBW	Gain bandwidth product	$R_L = 100\text{ k}\Omega$, $C_L = 200\text{ pF}$			1		MHz
Φ_m	Phase margin	$R_L = 100\text{ k}\Omega$			72		deg
G_m	Gain margin	$R_L = 100\text{ k}\Omega$			20		dB
e_n	Input-referred voltage noise	$f = 1\text{ kHz}$			40		$\text{nV}/\sqrt{\text{Hz}}$
i_n	Input-referred current noise	$f = 1\text{ kHz}$			0.001		$\text{pA}/\sqrt{\text{Hz}}$
THD	Total harmonic distortion	$f = 1\text{ kHz}$, $A_V = 1$ $R_L = 600\ \Omega$, $V_{IN} = 1\text{ V}_{PP}$			0.017%		

(1) Values apply only for factory testing conditions at the temperature indicated. Factory testing conditions result in very limited self-heating of the device such that $T_J = T_A$. No assurance of parametric performance is indicated in the electrical tables under conditions of internal self heating where $T_J > T_A$.

(2) Connected as voltage follower with $2\text{-}V_{PP}$ step input. Number specified is the slower of the positive and negative slew rates.

6.7 Electrical Characteristics – DC (5 V)

over operating free-air temperature range (unless otherwise noted)⁽¹⁾

PARAMETER		TEST CONDITIONS		MIN	TYP	MAX	UNIT
V _{OS}	Input offset voltage	LMV601			0.25	4	mV
		LMV602 and LMV604			0.7	5	
TCV _{OS}	Input offset voltage average drift				1.9		μV/°C
I _B	Input bias current				0.02		μA
I _{OS}	Input offset current				6.6		fA
I _S	Supply current	Per amplifier			107	200	μA
		Shutdown mode, V _{SD} = 0 V (LMV601)			0.033	1	μA
CMRR	Common-mode rejection ratio	0 V ≤ V _{CM} ≤ 4 V			86		dB
PSRR	Power supply rejection ratio	2.7 V ≤ V ⁺ ≤ 5 V			82		dB
V _{CM}	Input common-mode voltage	For CMRR ≥ 50 dB		0		4	V
A _V	Large signal voltage gain ⁽²⁾	R _L = 10 kΩ to 2.5 V			116		dB
V _O	Output swing	R _L = 10 kΩ to 2.5 V	Swing high		7	30	mV
			Swing low	30	7		
I _O	Output short-circuit current	Sourcing			113		mA
		Sinking			75		
t _{on}	Turnon time from shutdown	(LMV601)			5		μs
V _{SD}	Shutdown pin voltage range	ON mode (LMV601)			3.1	5	V
		Shutdown mode (LMV601)			0	0.8	

(1) Values apply only for factory testing conditions at the temperature indicated. Factory testing conditions result in very limited self-heating of the device such that T_J = T_A. No assurance of parametric performance is indicated in the electrical tables under conditions of internal self heating where T_J > T_A.

(2) R_L is connected to mid-supply. The output voltage is GND + 0.2 V ≤ V_O ≤ V⁺ – 0.2 V

6.8 Electrical Characteristics – AC (5 V)

Unless otherwise specified, all limits ensured for T_J = 25°C, V⁺ = 5 V, V⁻ = 0 V, V_{CM} = V⁺ / 2, V_O = V⁺ / 2 and R_L > 1 MΩ.

PARAMETER		TEST CONDITIONS		MIN	TYP	MAX	UNIT
SR	Slew rate	R _L = 10 kΩ, ⁽¹⁾			1		V/μs
GBW	Gain bandwidth product	R _L = 100 kΩ, C _L = 200 pF			1		MHz
Φ _m	Phase margin	R _L = 100 kΩ			72		°
G _m	Gain margin	R _L = 100 kΩ			20		dB
e _n	Input-referred voltage noise	f = 1 kHz			39		nV/√Hz
i _n	Input-referred current noise	f = 1 kHz			0.001		pA/√Hz
THD	Total harmonic distortion	f = 1 kHz, A _V = 1 R _L = 600 Ω, V _{IN} = 1 V _{PP}			0.012%		

(1) Connected as voltage follower with 2-V_{PP} step input. Number specified is the slower of the positive and negative slew rates.

6.9 Typical Characteristics

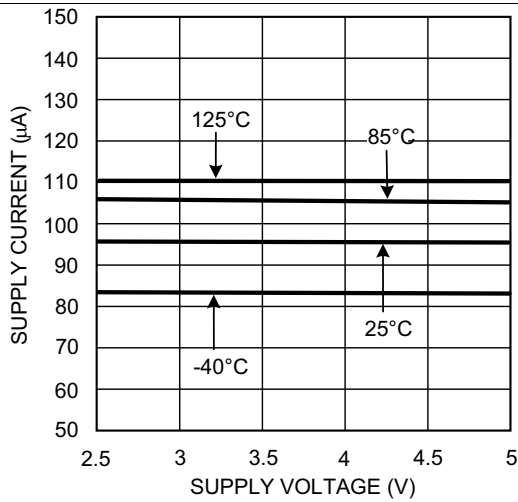

Figure 1. Supply Current vs Supply Voltage (LMV601)

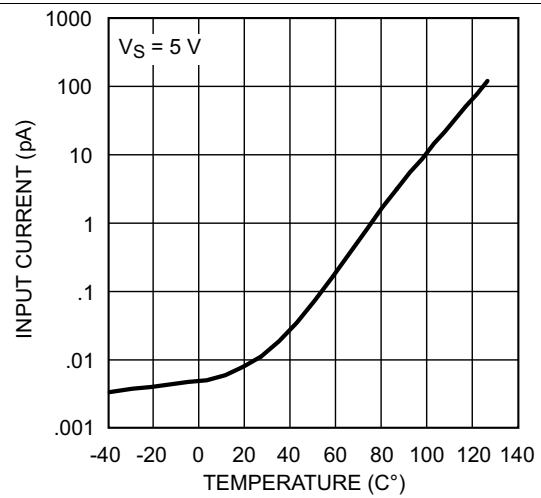

Figure 2. Input Current vs Temperature

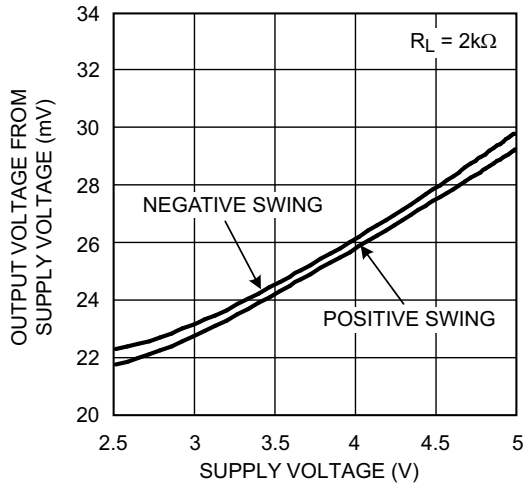

Figure 3. Output Voltage Swing vs Supply Voltage

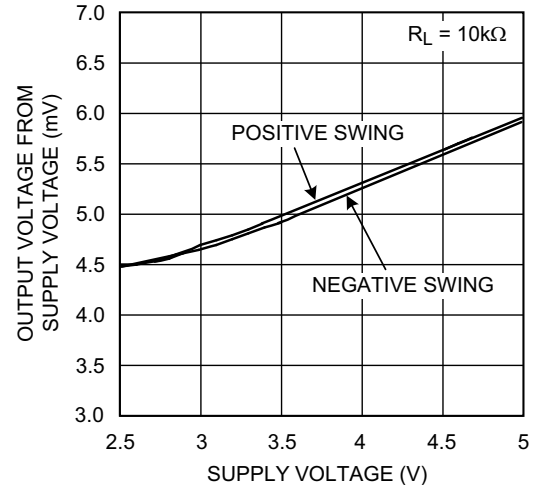

Figure 4. Output Voltage Swing vs Supply Voltage

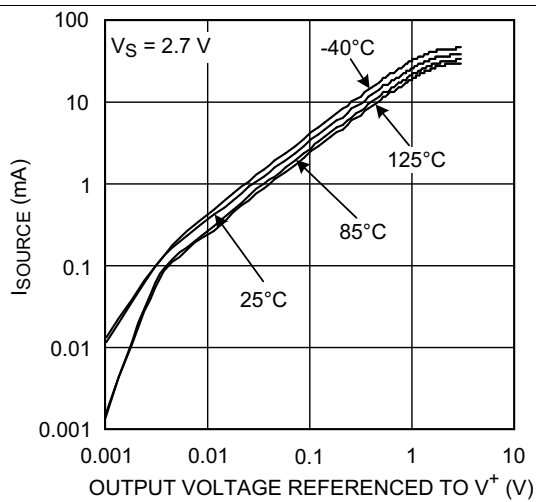

Figure 5. I_{SOURCE} vs V_{OUT}

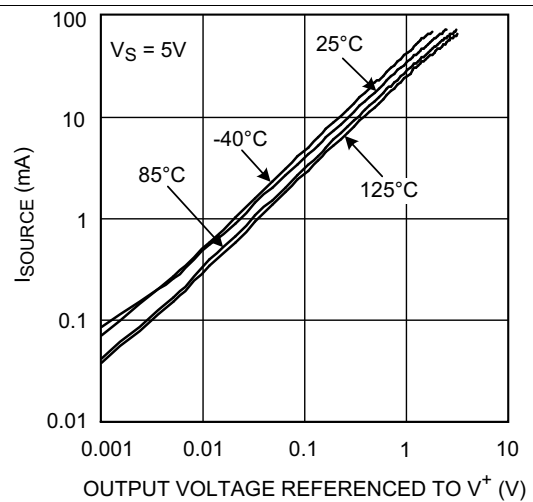

Figure 6. I_{SOURCE} vs V_{OUT}

Typical Characteristics (continued)

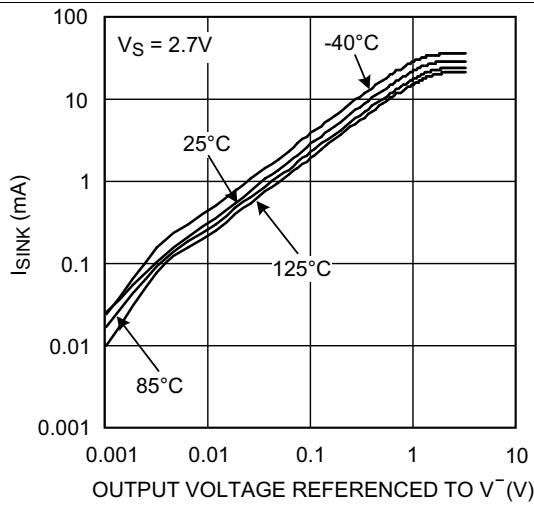

Figure 7. I_{SINK} vs V_{OUT}

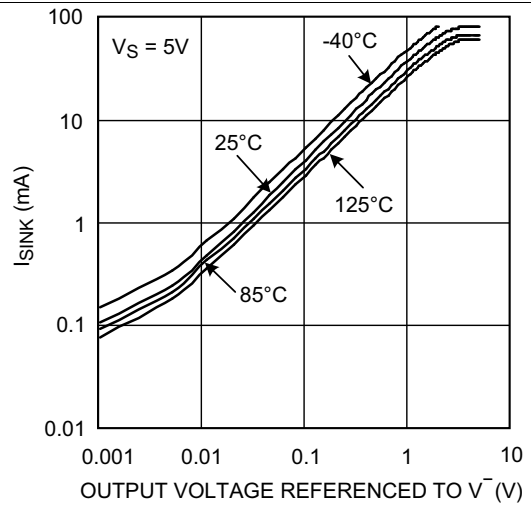

Figure 8. I_{SINK} vs V_{OUT}

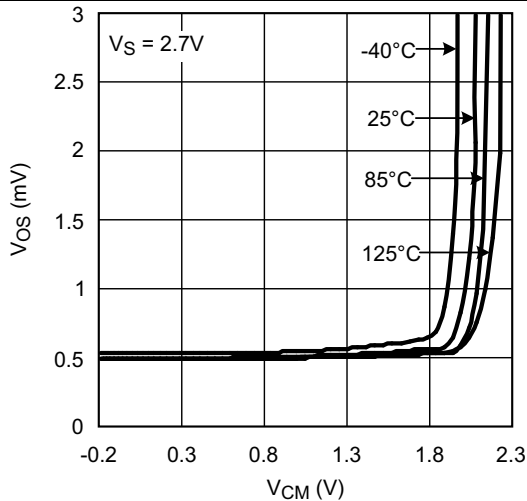

Figure 9. V_{OS} vs V_{CM}

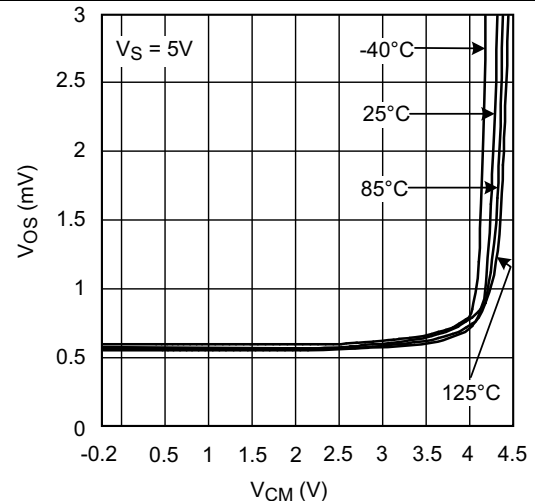

Figure 10. V_{OS} vs V_{CM}

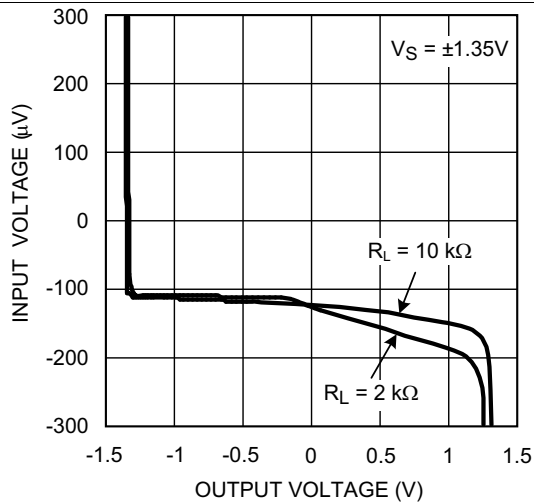

Figure 11. V_{IN} vs V_{OUT}

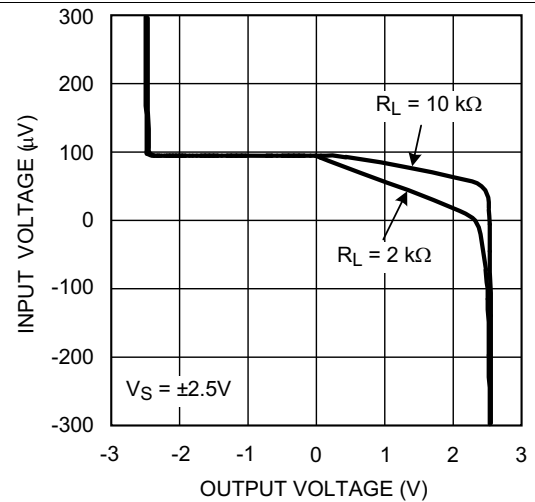

Figure 12. V_{IN} vs V_{OUT}

Typical Characteristics (continued)

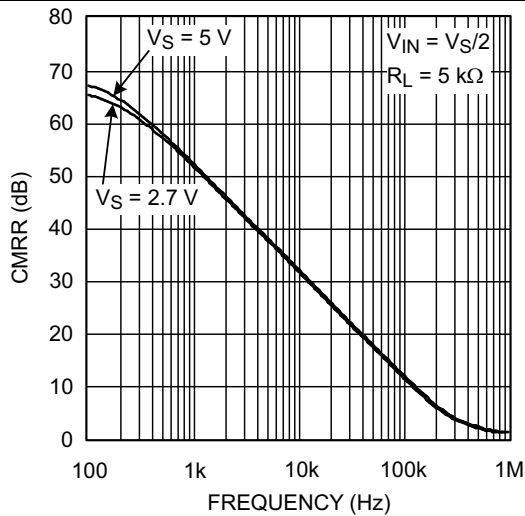

Figure 13. CMRR vs Frequency

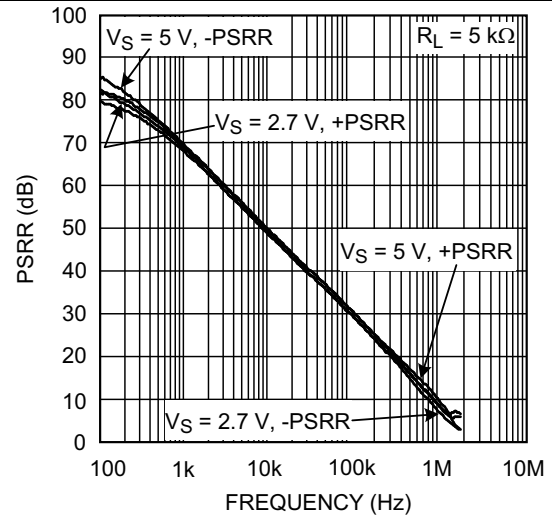

Figure 14. PSRR vs Frequency

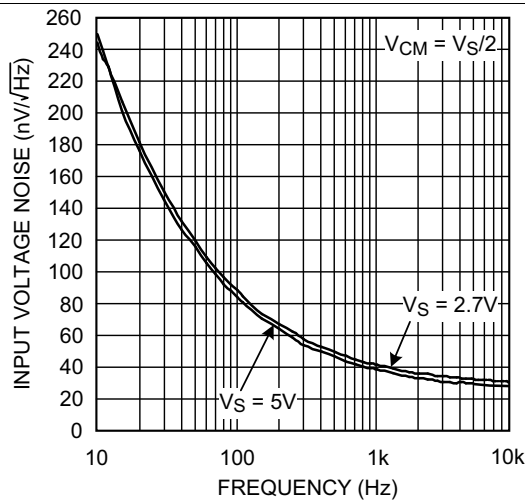

Figure 15. Input Voltage Noise vs Frequency

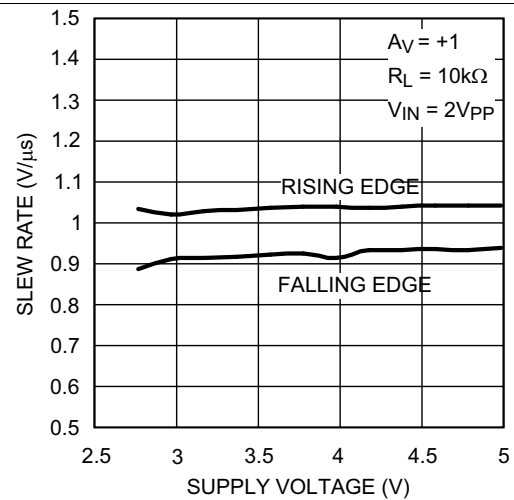

Figure 16. Slew Rate vs VSUPPLY

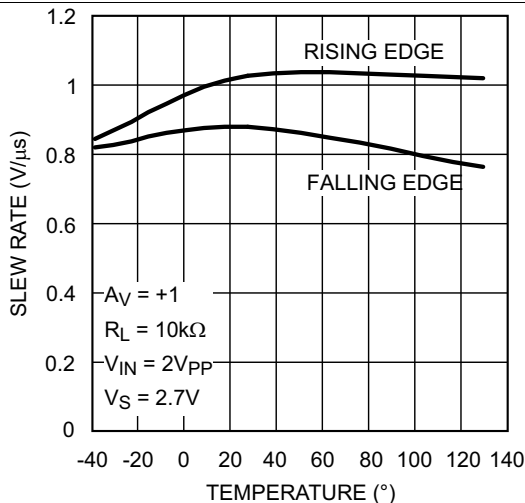

Figure 17. Slew Rate vs Temperature

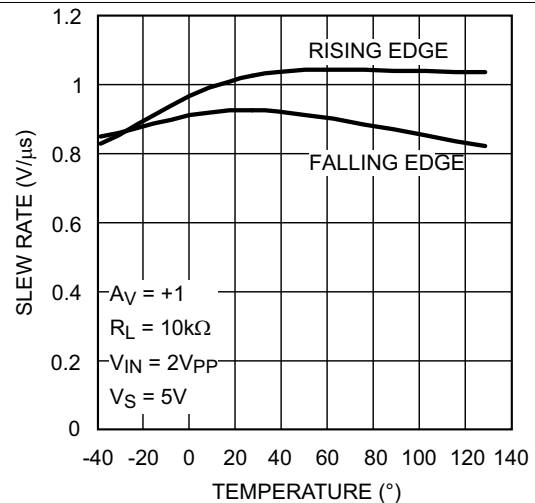

Figure 18. Slew Rate vs Temperature

Typical Characteristics (continued)

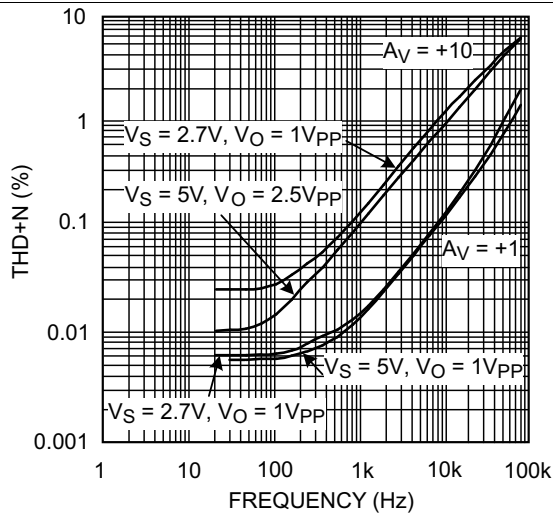

Figure 19. THD+N vs Frequency

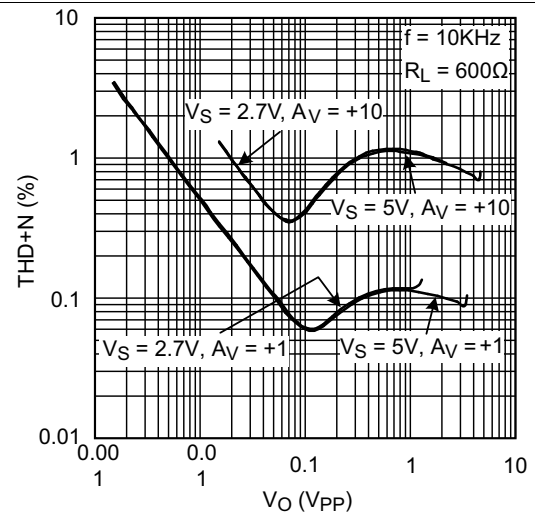

Figure 20. THD+N vs VOUT

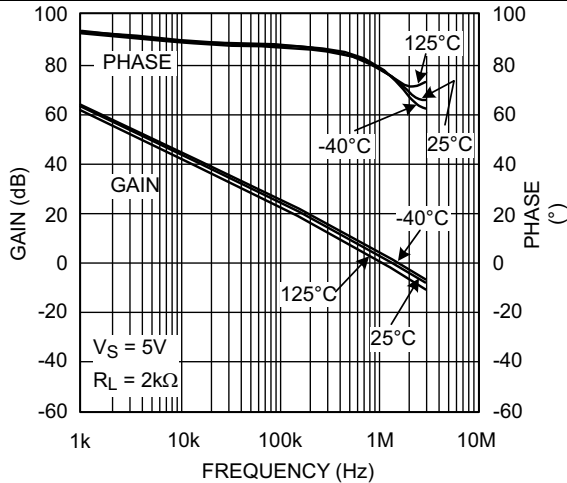

Figure 21. Open-Loop Frequency Over Temperature

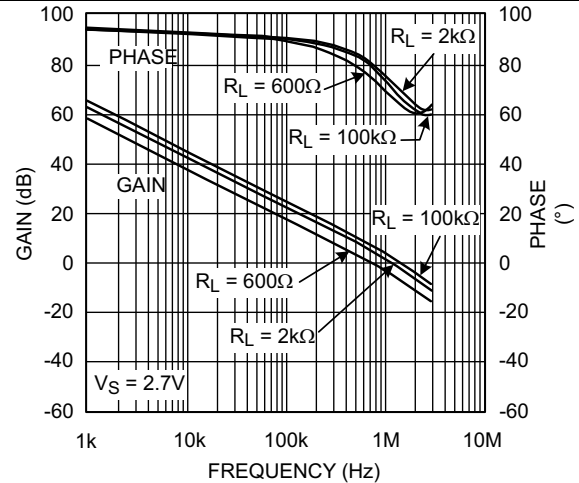

Figure 22. Open-Loop Frequency Response

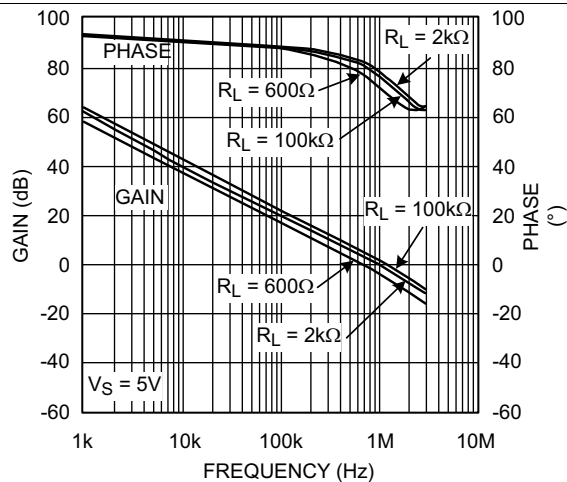

Figure 23. Open-Loop Frequency Response

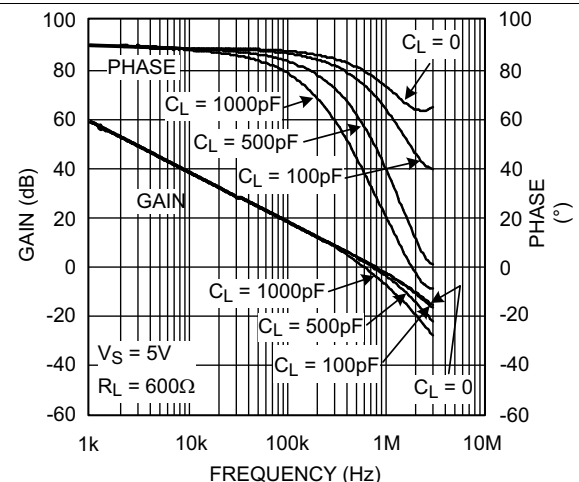

Figure 24. Gain and Phase vs CL

Typical Characteristics (continued)

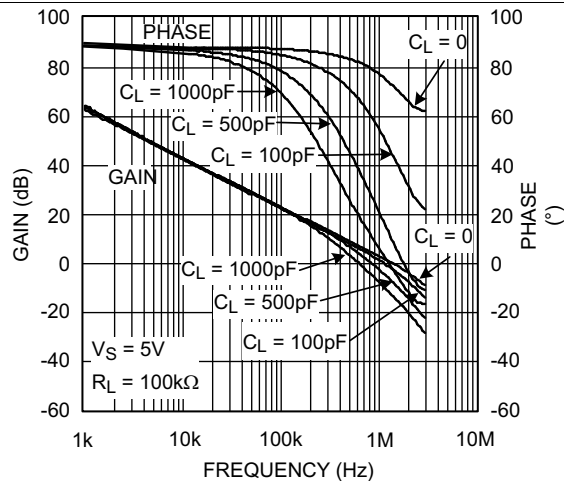

Figure 25. Gain and Phase vs C_L

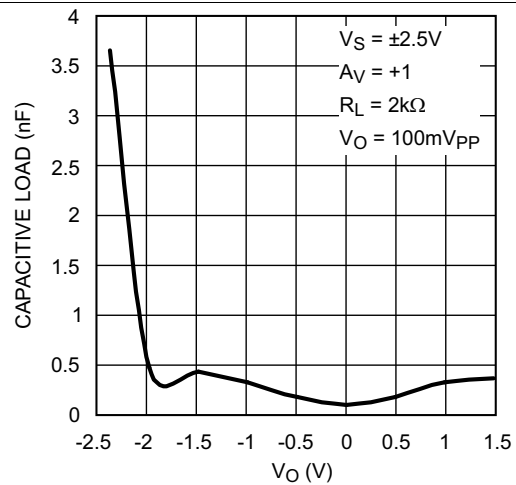

Figure 26. Stability vs Capacitive Load

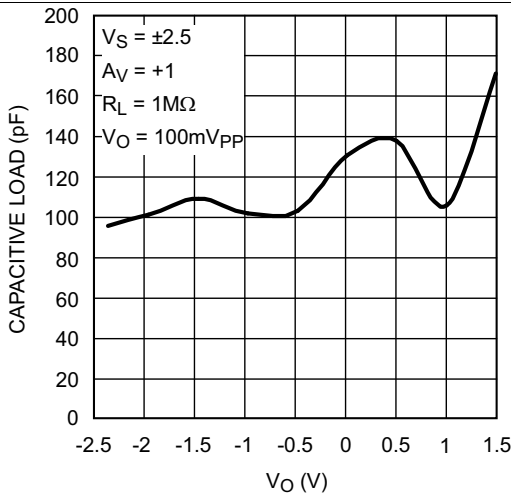

Figure 27. Stability vs Capacitive Load

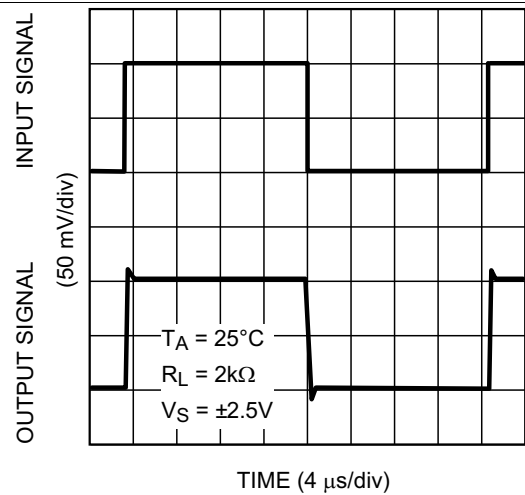

Figure 28. Noninverting Small Signal Pulse Response

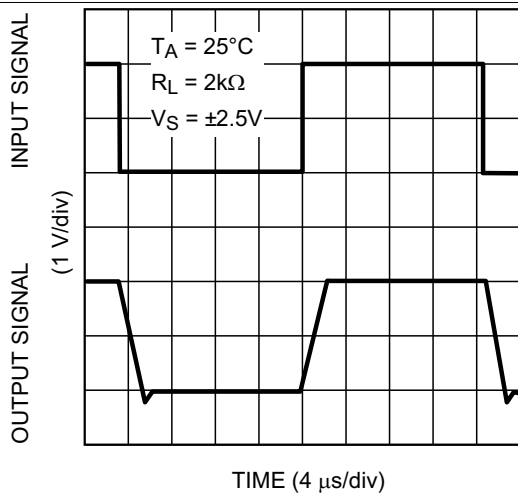

Figure 29. Noninverting Large Signal Pulse Response

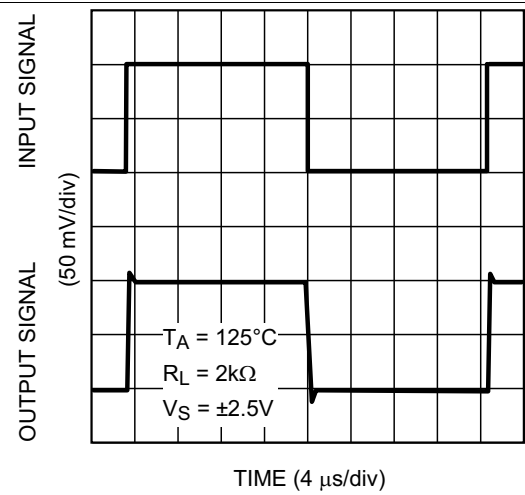
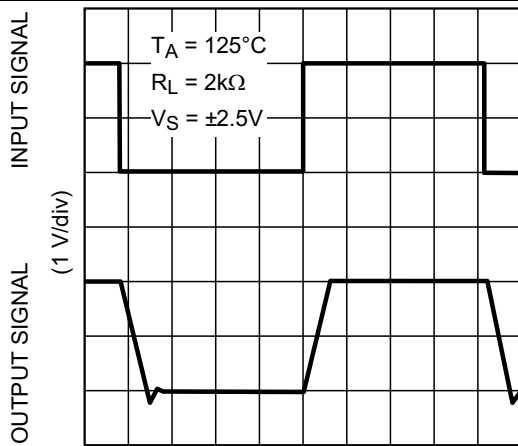

Figure 30. Noninverting Small Signal Pulse Response

Typical Characteristics (continued)



TIME (4 μs/div)

Figure 31. Noninverting Large Signal Pulse Response

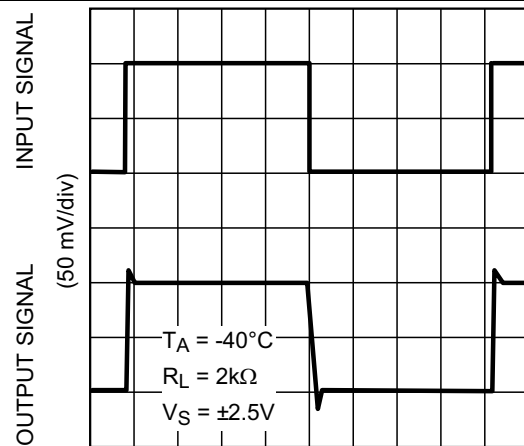

TIME (4 μs/div)

Figure 32. Noninverting Small Signal Pulse Response

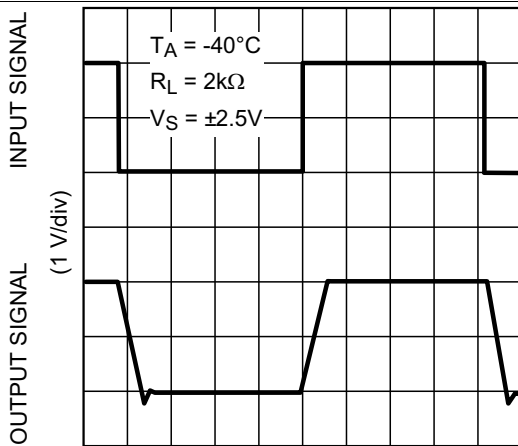

TIME (4 μs/div)

Figure 33. Noninverting Large Signal Pulse Response

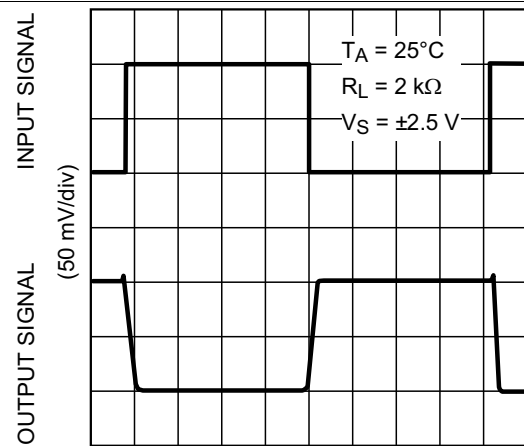

TIME (4 μs/div)

Figure 34. Inverting Small Signal Pulse Response

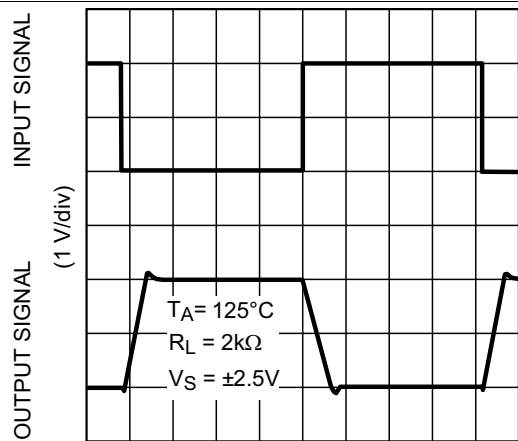

TIME (4 μs/div)

Figure 35. Inverting Large Signal Pulse Response

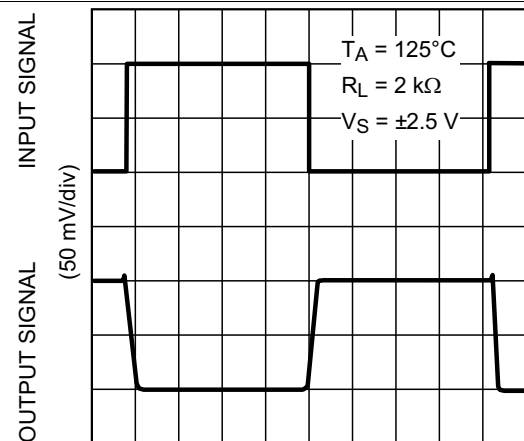

TIME (4 μs/div)

Figure 36. Inverting Small Signal Pulse Response

Typical Characteristics (continued)

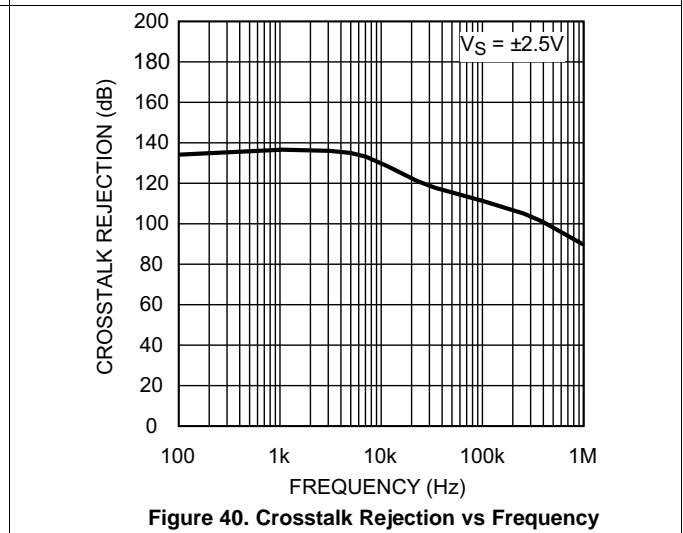
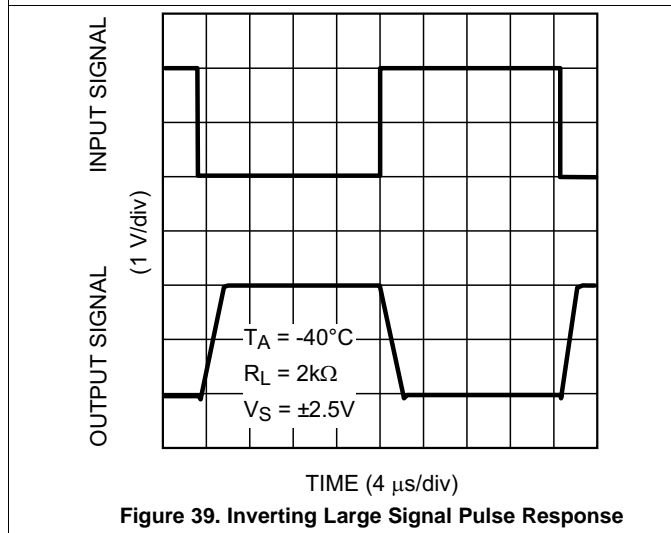
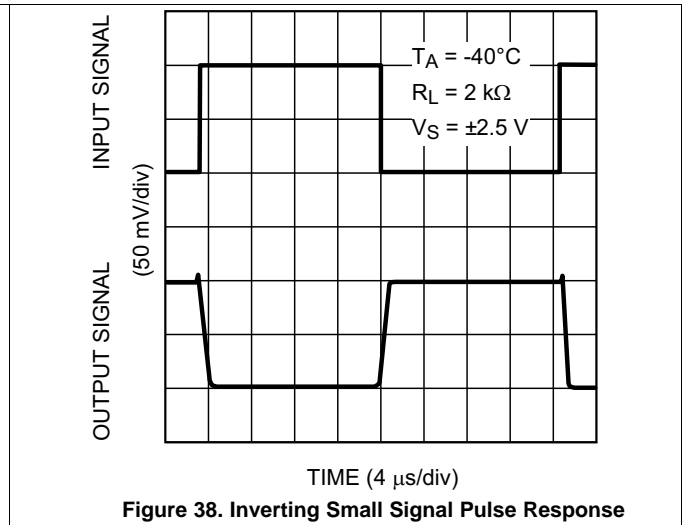
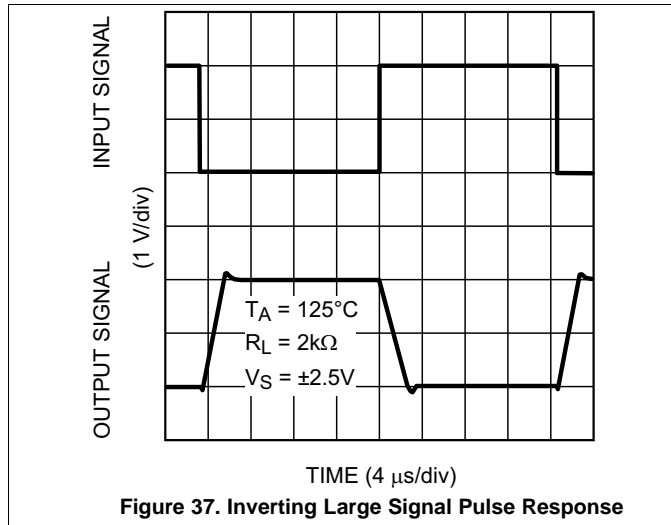

7 Detailed Description

7.1 Overview

The LMV60x family of amplifiers features low-voltage, low-power, and rail-to-rail output operational amplifiers designed for low-voltage portable applications. The family is designed using all CMOS technology. This results in an ultra-low input bias current. The LMV601 has a shutdown option, which can be used in portable devices to increase battery life.

A simplified schematic of the LMV60x family of amplifiers is shown in [Functional Block Diagram](#). The PMOS input differential pair allows the input to include ground. The output of this differential pair is connected to the Class AB turnaround stage. This Class AB turnaround has a lower quiescent current, compared to regular turnaround stages. This results in lower offset, noise, and power dissipation, while slew rate equals that of a conventional turnaround stage. The output of the Class AB turnaround stage provides gate voltage to the complementary common-source transistors at the output stage. These transistors enable the device to have rail-to-rail output.

7.2 Functional Block Diagram

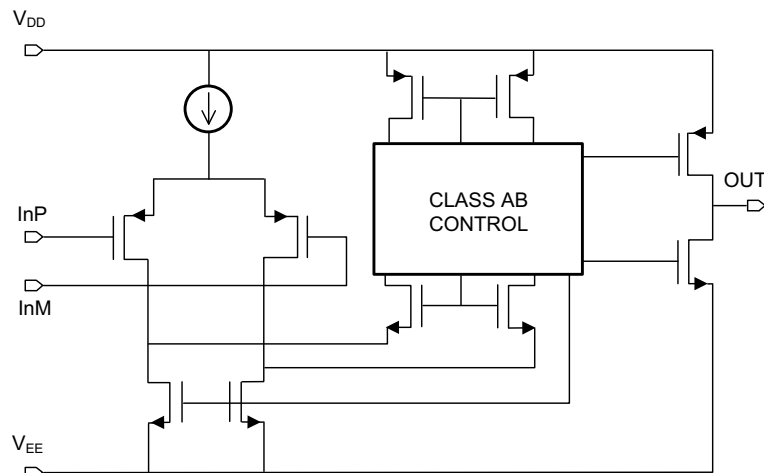

Copyright © 2016, Texas Instruments Incorporated

7.3 Feature Description

7.3.1 Class AB Turnaround Stage Amplifier

This patented folded cascode stage has a combined class AB amplifier stage, which replaces the conventional folded cascode stage. Therefore, the class AB folded cascode stage runs at a much lower quiescent current compared to conventional folded cascode stages. This results in significantly smaller offset and noise contributions. The reduced offset and noise contributions in turn reduce the offset voltage level and the voltage noise level at the input of the LMV60x. Also the lower quiescent current results in a high open-loop gain for the amplifier. The lower quiescent current does not affect the slew rate of the amplifier nor its ability to handle the total current swing coming from the input stage.

The input voltage noise of the device at low frequencies, below 1 kHz, is slightly higher than devices with a BJT input stage. However, the PMOS input stage results in a much lower input bias current and the input voltage noise drops at frequencies above 1 kHz.

7.4 Device Functional Modes

7.4.1 Low Input Bias Current

The LMV60x amplifiers have a PMOS input stage. As a result, they have a much lower input bias current than devices with BJT input stages. This feature makes these devices ideal for sensor circuits. A typical curve of the input bias current of the LMV601 is shown in [Figure 41](#).

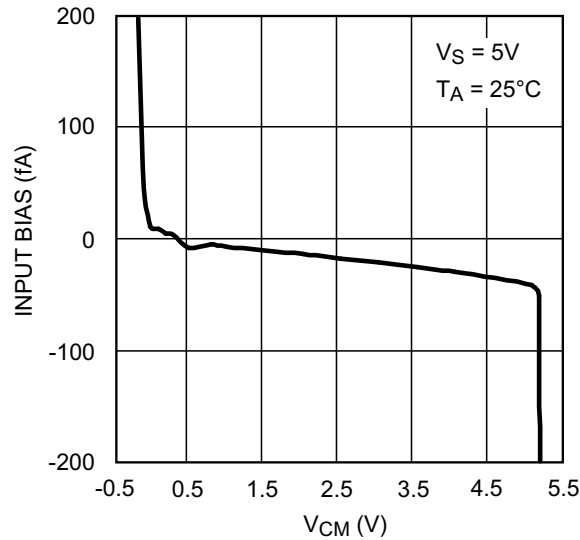
Device Functional Modes (continued)

Figure 41. Input Bias Current vs V_{CM}
7.4.2 Shutdown Feature

The LMV601 is capable of being turned off to conserve power and increase battery life in portable devices. Once in shutdown mode the supply current is drastically reduced, 1 μA maximum, and the output is *tri-stated*.

The device is disabled when the shutdown pin voltage is pulled low. The shutdown pin must never be left unconnected. Leaving the pin floating results in an undefined operation mode and the device may oscillate between shutdown and active modes.

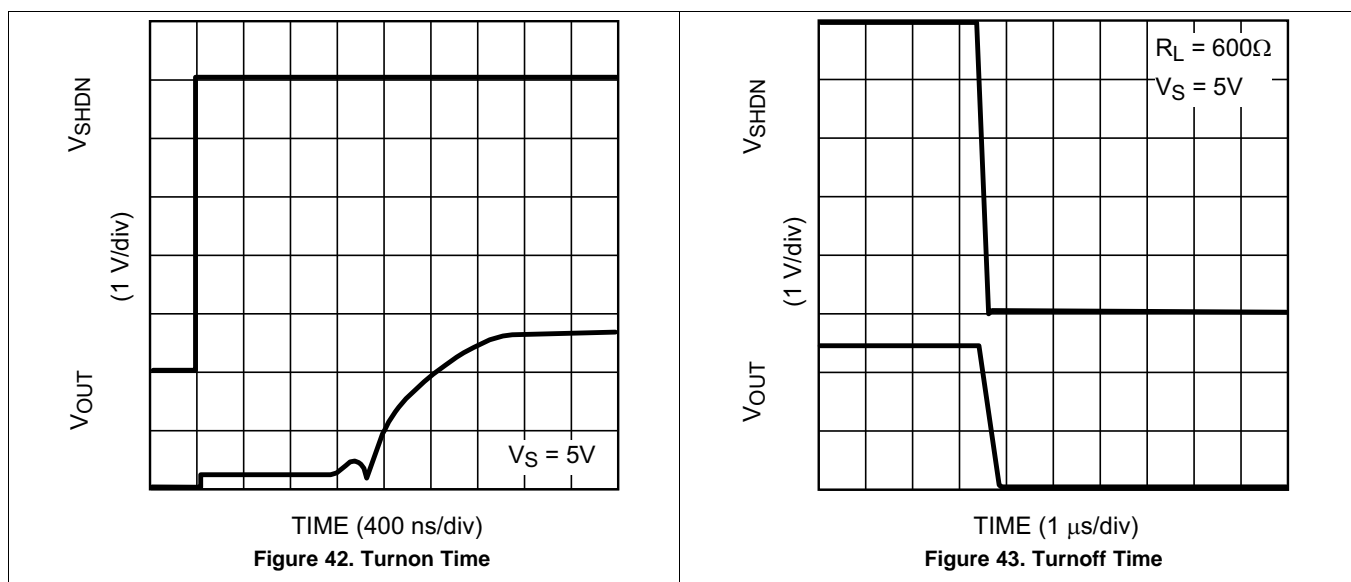
The LMV601 typically turns on 2.8 μs after the shutdown voltage is pulled high. The device turns off in less than 400 ns after shutdown voltage is pulled low. [Figure 42](#) and [Figure 43](#) show the turnon and turnoff time of the LMV601, respectively. To reduce the effect of the capacitance added to the circuit by the scope probe, in the turnoff time circuit a resistive load of 600 Ω is added. [Figure 44](#) and [Figure 45](#) show the test circuits used to obtain the two plots.



Device Functional Modes (continued)

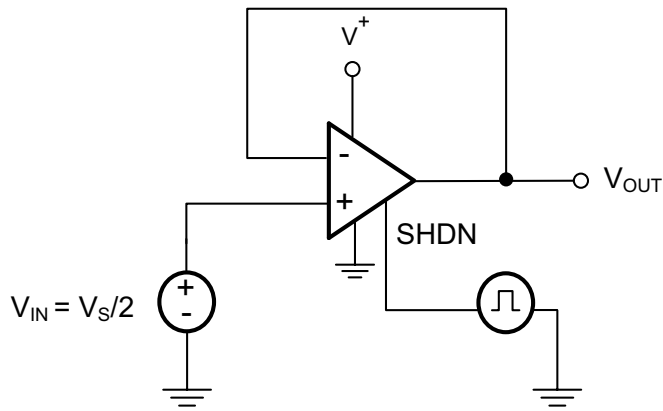

Figure 44. Turnon Time

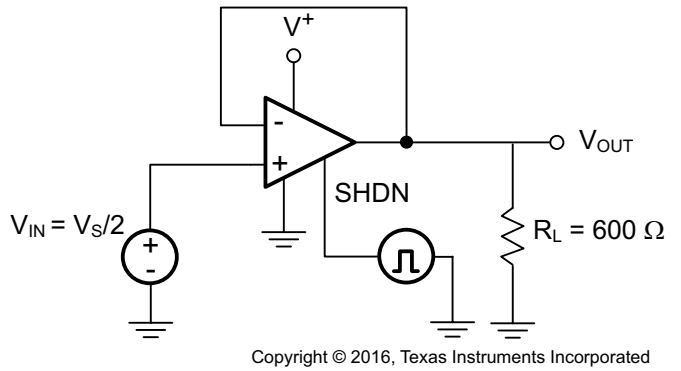

Figure 45. Turnoff Time

8 Application and Implementation

NOTE

Information in the following applications sections is not part of the TI component specification, and TI does not warrant its accuracy or completeness. TI's customers are responsible for determining suitability of components for their purposes. Customers should validate and test their design implementation to confirm system functionality.

8.1 Application Information

The LMV60x family of amplifiers features low-voltage, low-power, and rail-to-rail output operational amplifiers designed for low-voltage portable applications.

8.2 Typical Application

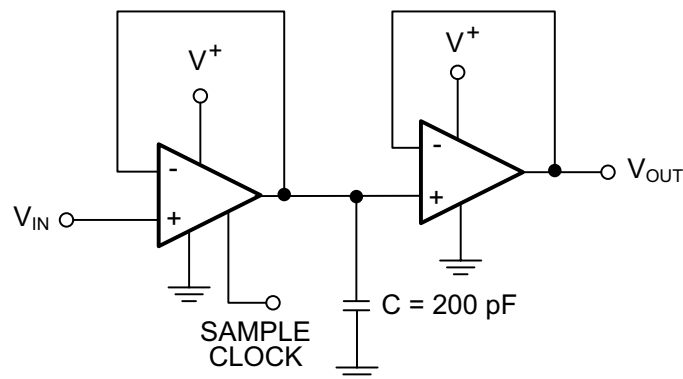

Copyright © 2016, Texas Instruments Incorporated

Figure 46. Sample and Hold Circuit

8.2.1 Design Requirements

The lower input bias current of the LMV601 results in a very high input impedance. The output impedance when the device is in shutdown mode is quite high. These high impedances, and the ability of the shutdown pin to be derived from a separate power source, make LMV601 a good choice for sample and hold circuits. The sample clock must be connected to the shutdown pin of the amplifier to rapidly turn the device on or off.

8.2.2 Detailed Design Procedure

Figure 46 shows the schematic of a simple sample-and-hold circuit. When the sample clock is high, the first amplifier is in normal operation mode and the second amplifier acts as a buffer. The capacitor, which appears as a load on the first amplifier, is charging at this time. The voltage across the capacitor is that of the noninverting input of the first amplifier because it is connected as a voltage-follower. When the sample clock is low, the first amplifier is shut off, bringing the output impedance to a high value. The high impedance of this output, along with the very high impedance on the input of the second amplifier, prevents the capacitor from discharging. There is very little voltage droop while the first amplifier is in shutdown mode. The second amplifier, which is still in normal operation mode and is connected as a voltage-follower, also provides the voltage sampled on the capacitor at its output.

Typical Application (continued)

8.2.3 Application Curve

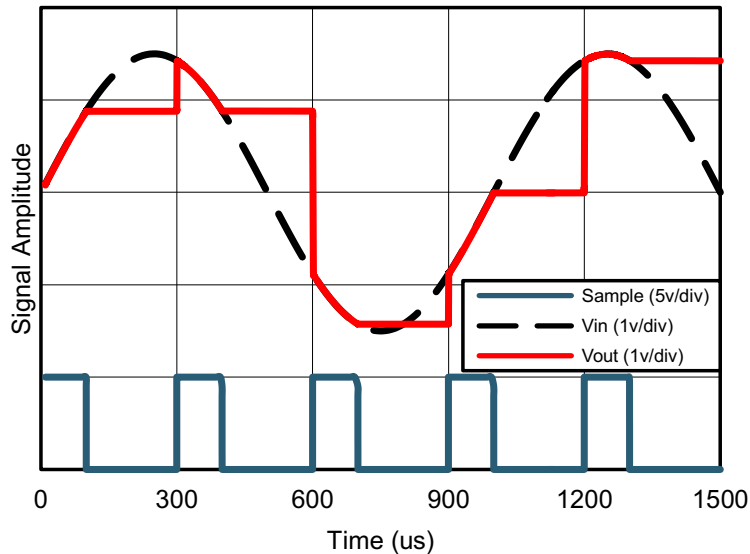

Figure 47. Sample-and-Hold Circuit Results

8.3 Dos and Don'ts

Do properly bypass the power supplies.

Do add series resistance to the output when driving capacitive loads, particularly cables, Muxes, and ADC inputs.

Do add series current-limiting resistors and external Schottky clamp diodes if input voltage is expected to exceed the supplies. Limit the current to 1 mA or less (1 k Ω per volt).

9 Power Supply Recommendations

For proper operation, the power supplies must be properly decoupled. For decoupling the supply lines, TI recommends that 10-nF capacitors be placed as close as possible to the operational amplifier power supply pins. For a single supply, place a capacitor between V⁺ and V⁻ supply leads. For dual supplies, place one capacitor between V⁺ and ground, and one capacitor between V⁻ and ground.

10 Layout

10.1 Layout Guideline

To properly bypass the power supply, consider the placement of several components on the printed-circuit board. A 6.8- μF or greater tantalum capacitor must be placed at the point where the power supply for the amplifier is introduced onto the board. Another 0.1- μF ceramic capacitor must be placed as close as possible to the power supply pin of the amplifier. If the amplifier is operated in a single power supply, only the V^+ pin must be bypassed with a 0.1- μF capacitor. If the amplifier is operated in a dual power supply, both V^+ and V^- pins must be bypassed.

It is good practice to use a ground plane on a printed-circuit board to provide all components with a low inductive ground connection.

TI recommends surface-mount components in 0805 size or smaller in the LMV601-N application circuits. Designers can take advantage of the VSSOP miniature sizes to condense board layout to save space and reduce stray capacitance.

10.2 Layout Example

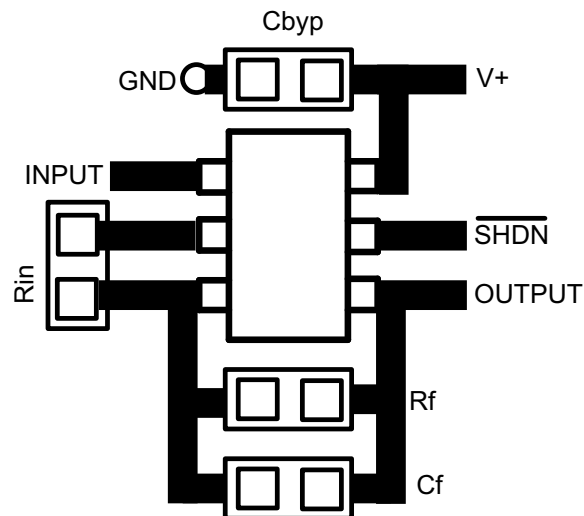

Figure 48. PCB Layout Example

11 Device and Documentation Support

11.1 Device Support

11.1.1 Development Support

- [LMV601 PSPICE Model](#) (zip file)
- [LMV601 PSPICE Model](#) (zip file)
- [LMV602 PSPICE Model](#) (zip file)
- [LMV604 PSPICE Model](#) (zip file)
- [TINA-TI SPICE-Based Analog Simulation Program](#)
- [DIP Adapter Evaluation Module](#)
- [TI Universal Operational Amplifier Evaluation Module](#)
- [TI Filterpro Software](#)

11.2 Documentation Support

11.2.1 Related Documentation

For additional applications, see the following:

[AN-31 Op Amp Circuit Collection](#) (SNLA140)

11.3 Related Links

The table below lists quick access links. Categories include technical documents, support and community resources, tools and software, and quick access to sample or buy.

Table 1. Related Links

PARTS	PRODUCT FOLDER	SAMPLE & BUY	TECHNICAL DOCUMENTS	TOOLS & SOFTWARE	SUPPORT & COMMUNITY
LMV601	Click here	Click here	Click here	Click here	Click here
LMV602	Click here	Click here	Click here	Click here	Click here
LMV604	Click here	Click here	Click here	Click here	Click here

11.4 Receiving Notification of Documentation Updates

To receive notification of documentation updates, navigate to the device product folder on ti.com. In the upper right corner, click on *Alert me* to register and receive a weekly digest of any product information that has changed. For change details, review the revision history included in any revised document.

11.5 Community Resources

The following links connect to TI community resources. Linked contents are provided "AS IS" by the respective contributors. They do not constitute TI specifications and do not necessarily reflect TI's views; see TI's [Terms of Use](#).

TI E2E™ Online Community *TI's Engineer-to-Engineer (E2E) Community*. Created to foster collaboration among engineers. At e2e.ti.com, you can ask questions, share knowledge, explore ideas and help solve problems with fellow engineers.

Design Support *TI's Design Support* Quickly find helpful E2E forums along with design support tools and contact information for technical support.

11.6 Trademarks

E2E is a trademark of Texas Instruments.

All other trademarks are the property of their respective owners.

11.7 Electrostatic Discharge Caution



These devices have limited built-in ESD protection. The leads should be shorted together or the device placed in conductive foam during storage or handling to prevent electrostatic damage to the MOS gates.

11.8 Glossary

[SLYZ022](#) — *TI Glossary*.

This glossary lists and explains terms, acronyms, and definitions.

12 Mechanical, Packaging, and Orderable Information

The following pages include mechanical, packaging, and orderable information. This information is the most current data available for the designated devices. This data is subject to change without notice and revision of this document. For browser-based versions of this data sheet, refer to the left-hand navigation.

PACKAGING INFORMATION

Orderable Device	Status (1)	Package Type	Package Drawing	Pins	Package Qty	Eco Plan (2)	Lead/Ball Finish (6)	MSL Peak Temp (3)	Op Temp (°C)	Device Marking (4/5)	Samples
LMV601MG/NOPB	ACTIVE	SC70	DCK	6	1000	Green (RoHS & no Sb/Br)	CU SN	Level-1-260C-UNLIM	-40 to 125	AUA	Samples
LMV601MGX/NOPB	ACTIVE	SC70	DCK	6	3000	Green (RoHS & no Sb/Br)	CU SN	Level-1-260C-UNLIM	-40 to 125	AUA	Samples
LMV602MA/NOPB	ACTIVE	SOIC	D	8	95	Green (RoHS & no Sb/Br)	CU SN	Level-1-260C-UNLIM	-40 to 125	LMV60 2MA	Samples
LMV602MAX/NOPB	ACTIVE	SOIC	D	8	2500	Green (RoHS & no Sb/Br)	CU SN	Level-1-260C-UNLIM	-40 to 125	LMV60 2MA	Samples
LMV602MM/NOPB	ACTIVE	VSSOP	DGK	8	1000	Green (RoHS & no Sb/Br)	CU SN	Level-1-260C-UNLIM	-40 to 125	AC9A	Samples
LMV602MMX/NOPB	ACTIVE	VSSOP	DGK	8	3500	Green (RoHS & no Sb/Br)	CU SN	Level-1-260C-UNLIM	-40 to 125	AC9A	Samples
LMV604MA/NOPB	ACTIVE	SOIC	D	14	55	Green (RoHS & no Sb/Br)	CU SN	Level-1-260C-UNLIM	-40 to 125	LMV604MA	Samples
LMV604MAX/NOPB	ACTIVE	SOIC	D	14	2500	Green (RoHS & no Sb/Br)	CU SN	Level-1-260C-UNLIM	-40 to 125	LMV604MA	Samples
LMV604MT/NOPB	ACTIVE	TSSOP	PW	14	94	Green (RoHS & no Sb/Br)	CU NIPDAU CU SN	Level-1-260C-UNLIM	-40 to 125	LMV604 MT	Samples
LMV604MTX/NOPB	ACTIVE	TSSOP	PW	14	2500	Green (RoHS & no Sb/Br)	CU NIPDAU CU SN	Level-1-260C-UNLIM	-40 to 125	LMV604 MT	Samples

(1) The marketing status values are defined as follows:

ACTIVE: Product device recommended for new designs.

LIFEBUY: TI has announced that the device will be discontinued, and a lifetime-buy period is in effect.

NRND: Not recommended for new designs. Device is in production to support existing customers, but TI does not recommend using this part in a new design.

PREVIEW: Device has been announced but is not in production. Samples may or may not be available.

OBSOLETE: TI has discontinued the production of the device.

(2) Eco Plan - The planned eco-friendly classification: Pb-Free (RoHS), Pb-Free (RoHS Exempt), or Green (RoHS & no Sb/Br) - please check <http://www.ti.com/productcontent> for the latest availability information and additional product content details.

TBD: The Pb-Free/Green conversion plan has not been defined.

Pb-Free (RoHS): TI's terms "Lead-Free" or "Pb-Free" mean semiconductor products that are compatible with the current RoHS requirements for all 6 substances, including the requirement that lead not exceed 0.1% by weight in homogeneous materials. Where designed to be soldered at high temperatures, TI Pb-Free products are suitable for use in specified lead-free processes.

Pb-Free (RoHS Exempt): This component has a RoHS exemption for either 1) lead-based flip-chip solder bumps used between the die and package, or 2) lead-based die adhesive used between the die and leadframe. The component is otherwise considered Pb-Free (RoHS compatible) as defined above.

Green (RoHS & no Sb/Br): TI defines "Green" to mean Pb-Free (RoHS compatible), and free of Bromine (Br) and Antimony (Sb) based flame retardants (Br or Sb do not exceed 0.1% by weight in homogeneous material)

- (3) MSL, Peak Temp. - The Moisture Sensitivity Level rating according to the JEDEC industry standard classifications, and peak solder temperature.
- (4) There may be additional marking, which relates to the logo, the lot trace code information, or the environmental category on the device.
- (5) Multiple Device Markings will be inside parentheses. Only one Device Marking contained in parentheses and separated by a "~" will appear on a device. If a line is indented then it is a continuation of the previous line and the two combined represent the entire Device Marking for that device.
- (6) Lead/Ball Finish - Orderable Devices may have multiple material finish options. Finish options are separated by a vertical ruled line. Lead/Ball Finish values may wrap to two lines if the finish value exceeds the maximum column width.

Important Information and Disclaimer:The information provided on this page represents TI's knowledge and belief as of the date that it is provided. TI bases its knowledge and belief on information provided by third parties, and makes no representation or warranty as to the accuracy of such information. Efforts are underway to better integrate information from third parties. TI has taken and continues to take reasonable steps to provide representative and accurate information but may not have conducted destructive testing or chemical analysis on incoming materials and chemicals. TI and TI suppliers consider certain information to be proprietary, and thus CAS numbers and other limited information may not be available for release.

In no event shall TI's liability arising out of such information exceed the total purchase price of the TI part(s) at issue in this document sold by TI to Customer on an annual basis.

TAPE AND REEL INFORMATION

QUADRANT ASSIGNMENTS FOR PIN 1 ORIENTATION IN TAPE

*All dimensions are nominal

Device	Package Type	Package Drawing	Pins	SPQ	Reel Diameter (mm)	Reel Width W1 (mm)	A0 (mm)	B0 (mm)	K0 (mm)	P1 (mm)	W (mm)	Pin1 Quadrant
LMV601MG/NOPB	SC70	DCK	6	1000	178.0	8.4	2.25	2.45	1.2	4.0	8.0	Q3
LMV601MGX/NOPB	SC70	DCK	6	3000	178.0	8.4	2.25	2.45	1.2	4.0	8.0	Q3
LMV602MAX/NOPB	SOIC	D	8	2500	330.0	12.4	6.5	5.4	2.0	8.0	12.0	Q1
LMV602MM/NOPB	VSSOP	DGK	8	1000	178.0	12.4	5.3	3.4	1.4	8.0	12.0	Q1
LMV602MMX/NOPB	VSSOP	DGK	8	3500	330.0	12.4	5.3	3.4	1.4	8.0	12.0	Q1
LMV604MAX/NOPB	SOIC	D	14	2500	330.0	16.4	6.5	9.35	2.3	8.0	16.0	Q1
LMV604MTX/NOPB	TSSOP	PW	14	2500	330.0	12.4	6.95	5.6	1.6	8.0	12.0	Q1
LMV604MTX/NOPB	TSSOP	PW	14	2500	330.0	12.4	6.95	5.6	1.6	8.0	12.0	Q1

TAPE AND REEL BOX DIMENSIONS

*All dimensions are nominal

Device	Package Type	Package Drawing	Pins	SPQ	Length (mm)	Width (mm)	Height (mm)
LMV601MG/NOPB	SC70	DCK	6	1000	210.0	185.0	35.0
LMV601MGX/NOPB	SC70	DCK	6	3000	210.0	185.0	35.0
LMV602MAX/NOPB	SOIC	D	8	2500	367.0	367.0	35.0
LMV602MM/NOPB	VSSOP	DGK	8	1000	210.0	185.0	35.0
LMV602MMX/NOPB	VSSOP	DGK	8	3500	367.0	367.0	35.0
LMV604MAX/NOPB	SOIC	D	14	2500	367.0	367.0	35.0
LMV604MTX/NOPB	TSSOP	PW	14	2500	367.0	367.0	35.0
LMV604MTX/NOPB	TSSOP	PW	14	2500	367.0	367.0	35.0

DGK (S-PDSO-G8)

PLASTIC SMALL-OUTLINE PACKAGE

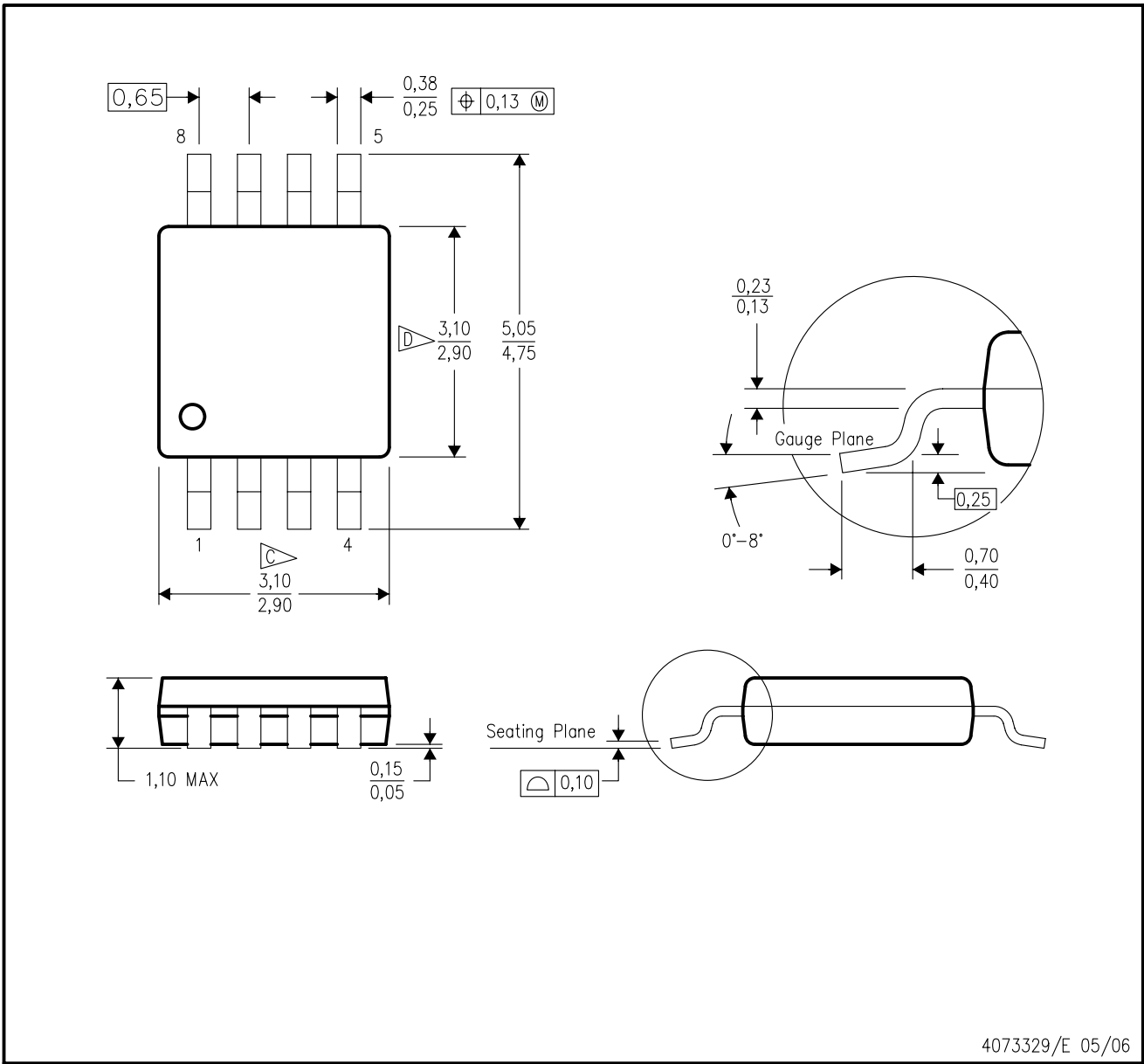

- NOTES:
- A. All linear dimensions are in millimeters.
 - B. This drawing is subject to change without notice.
 - C. Body length does not include mold flash, protrusions, or gate burrs. Mold flash, protrusions, or gate burrs shall not exceed 0.15 per end.
 - D. Body width does not include interlead flash. Interlead flash shall not exceed 0.50 per side.
 - E. Falls within JEDEC MO-187 variation AA, except interlead flash.



- NOTES:
- A. All linear dimensions are in millimeters.
 - B. This drawing is subject to change without notice.
 - C. Publication IPC-7351 is recommended for alternate designs.
 - D. Laser cutting apertures with trapezoidal walls and also rounding corners will offer better paste release. Customers should contact their board assembly site for stencil design recommendations. Refer to IPC-7525 for other stencil recommendations.
 - E. Customers should contact their board fabrication site for solder mask tolerances between and around signal pads.

DCK (R-PDSO-G6)

PLASTIC SMALL-OUTLINE PACKAGE

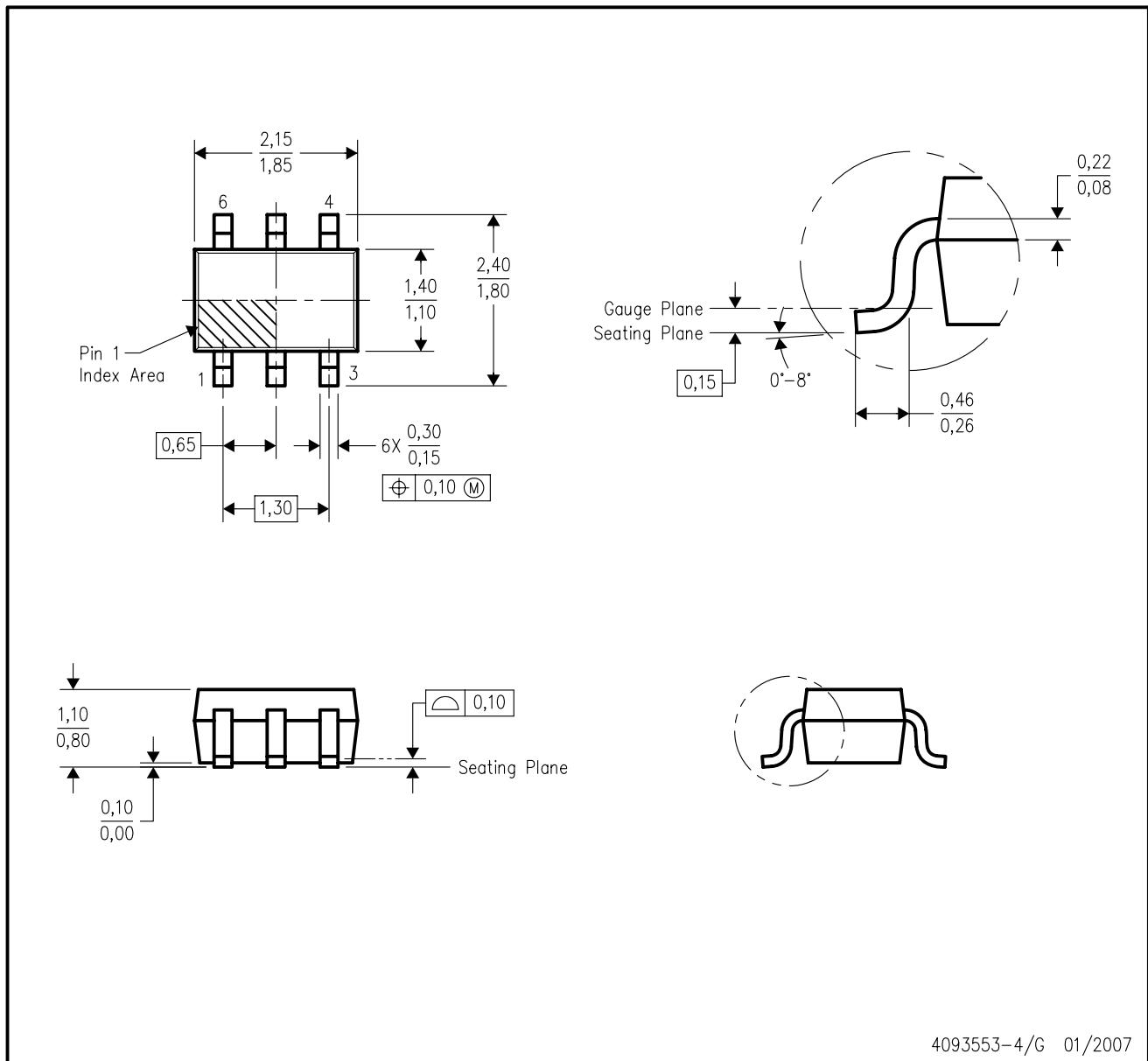

- NOTES:
- A. All linear dimensions are in millimeters.
 - B. This drawing is subject to change without notice.
 - C. Body dimensions do not include mold flash or protrusion. Mold flash and protrusion shall not exceed 0.15 per side.
 - D. Falls within JEDEC MO-203 variation AB.

DCK (R-PDSO-G6)

PLASTIC SMALL OUTLINE



- NOTES:
- A. All linear dimensions are in millimeters.
 - B. This drawing is subject to change without notice.
 - C. Customers should place a note on the circuit board fabrication drawing not to alter the center solder mask defined pad.
 - D. Publication IPC-7351 is recommended for alternate designs.
 - E. Laser cutting apertures with trapezoidal walls and also rounding corners will offer better paste release. Customers should contact their board assembly site for stencil design recommendations. Example stencil design based on a 50% volumetric metal load solder paste. Refer to IPC-7525 for other stencil recommendations.

D (R-PDSO-G14)

PLASTIC SMALL OUTLINE



- NOTES:
- A. All linear dimensions are in inches (millimeters).
 - B. This drawing is subject to change without notice.
 -  Body length does not include mold flash, protrusions, or gate burrs. Mold flash, protrusions, or gate burrs shall not exceed 0.006 (0,15) each side.
 -  Body width does not include interlead flash. Interlead flash shall not exceed 0.017 (0,43) each side.
 - E. Reference JEDEC MS-012 variation AB.

PW (R-PDSO-G14)

PLASTIC SMALL OUTLINE



4040064-3/G 02/11

- NOTES:
- A. All linear dimensions are in millimeters. Dimensioning and tolerancing per ASME Y14.5M-1994.
 - B. This drawing is subject to change without notice.
 -  C. Body length does not include mold flash, protrusions, or gate burrs. Mold flash, protrusions, or gate burrs shall not exceed 0,15 each side.
 -  D. Body width does not include interlead flash. Interlead flash shall not exceed 0,25 each side.
 - E. Falls within JEDEC MO-153

PW (R-PDSO-G14)

PLASTIC SMALL OUTLINE



4211284-2/G 08/15



- NOTES:
- A. All linear dimensions are in millimeters.
 - B. This drawing is subject to change without notice.
 - C. Publication IPC-7351 is recommended for alternate designs.
 - D. Laser cutting apertures with trapezoidal walls and also rounding corners will offer better paste release. Customers should contact their board assembly site for stencil design recommendations. Refer to IPC-7525 for other stencil recommendations.
 - E. Customers should contact their board fabrication site for solder mask tolerances between and around signal pads.

D (R-PDSO-G8)

PLASTIC SMALL OUTLINE



4040047-3/M 06/11

- NOTES:
- A. All linear dimensions are in inches (millimeters).
 - B. This drawing is subject to change without notice.
 -  Body length does not include mold flash, protrusions, or gate burrs. Mold flash, protrusions, or gate burrs shall not exceed 0.006 (0,15) each side.
 -  Body width does not include interlead flash. Interlead flash shall not exceed 0.017 (0,43) each side.
 - E. Reference JEDEC MS-012 variation AA.

IMPORTANT NOTICE

Texas Instruments Incorporated and its subsidiaries (TI) reserve the right to make corrections, enhancements, improvements and other changes to its semiconductor products and services per JESD46, latest issue, and to discontinue any product or service per JESD48, latest issue. Buyers should obtain the latest relevant information before placing orders and should verify that such information is current and complete. All semiconductor products (also referred to herein as "components") are sold subject to TI's terms and conditions of sale supplied at the time of order acknowledgment.

TI warrants performance of its components to the specifications applicable at the time of sale, in accordance with the warranty in TI's terms and conditions of sale of semiconductor products. Testing and other quality control techniques are used to the extent TI deems necessary to support this warranty. Except where mandated by applicable law, testing of all parameters of each component is not necessarily performed.

TI assumes no liability for applications assistance or the design of Buyers' products. Buyers are responsible for their products and applications using TI components. To minimize the risks associated with Buyers' products and applications, Buyers should provide adequate design and operating safeguards.

TI does not warrant or represent that any license, either express or implied, is granted under any patent right, copyright, mask work right, or other intellectual property right relating to any combination, machine, or process in which TI components or services are used. Information published by TI regarding third-party products or services does not constitute a license to use such products or services or a warranty or endorsement thereof. Use of such information may require a license from a third party under the patents or other intellectual property of the third party, or a license from TI under the patents or other intellectual property of TI.

Reproduction of significant portions of TI information in TI data books or data sheets is permissible only if reproduction is without alteration and is accompanied by all associated warranties, conditions, limitations, and notices. TI is not responsible or liable for such altered documentation. Information of third parties may be subject to additional restrictions.

Resale of TI components or services with statements different from or beyond the parameters stated by TI for that component or service voids all express and any implied warranties for the associated TI component or service and is an unfair and deceptive business practice. TI is not responsible or liable for any such statements.

Buyer acknowledges and agrees that it is solely responsible for compliance with all legal, regulatory and safety-related requirements concerning its products, and any use of TI components in its applications, notwithstanding any applications-related information or support that may be provided by TI. Buyer represents and agrees that it has all the necessary expertise to create and implement safeguards which anticipate dangerous consequences of failures, monitor failures and their consequences, lessen the likelihood of failures that might cause harm and take appropriate remedial actions. Buyer will fully indemnify TI and its representatives against any damages arising out of the use of any TI components in safety-critical applications.

In some cases, TI components may be promoted specifically to facilitate safety-related applications. With such components, TI's goal is to help enable customers to design and create their own end-product solutions that meet applicable functional safety standards and requirements. Nonetheless, such components are subject to these terms.

No TI components are authorized for use in FDA Class III (or similar life-critical medical equipment) unless authorized officers of the parties have executed a special agreement specifically governing such use.

Only those TI components which TI has specifically designated as military grade or "enhanced plastic" are designed and intended for use in military/aerospace applications or environments. Buyer acknowledges and agrees that any military or aerospace use of TI components which have **not** been so designated is solely at the Buyer's risk, and that Buyer is solely responsible for compliance with all legal and regulatory requirements in connection with such use.

TI has specifically designated certain components as meeting ISO/TS16949 requirements, mainly for automotive use. In any case of use of non-designated products, TI will not be responsible for any failure to meet ISO/TS16949.

Products

Audio	www.ti.com/audio
Amplifiers	amplifier.ti.com
Data Converters	dataconverter.ti.com
DLP® Products	www.dlp.com
DSP	dsp.ti.com
Clocks and Timers	www.ti.com/clocks
Interface	interface.ti.com
Logic	logic.ti.com
Power Mgmt	power.ti.com
Microcontrollers	microcontroller.ti.com
RFID	www.ti-rfid.com
OMAP Applications Processors	www.ti.com/omap
Wireless Connectivity	www.ti.com/wirelessconnectivity

Applications

Automotive and Transportation	www.ti.com/automotive
Communications and Telecom	www.ti.com/communications
Computers and Peripherals	www.ti.com/computers
Consumer Electronics	www.ti.com/consumer-apps
Energy and Lighting	www.ti.com/energy
Industrial	www.ti.com/industrial
Medical	www.ti.com/medical
Security	www.ti.com/security
Space, Avionics and Defense	www.ti.com/space-avionics-defense
Video and Imaging	www.ti.com/video

TI E2E Community

e2e.ti.com