

LMH6624/LMH6626

Single/Dual Ultra Low Noise Wideband Operational Amplifier

General Description

The LMH6624/LMH6626 offer wide bandwidth (1.5GHz for single, 1.3GHz for dual) with very low input noise ($0.92\text{nV}/\sqrt{\text{Hz}}$, $2.3\text{pA}/\sqrt{\text{Hz}}$) and ultra low dc errors ($100\mu\text{V } V_{\text{OS}}$, $\pm 0.1\mu\text{V}/^\circ\text{C}$ drift) providing very precise operational amplifiers with wide dynamic range. This enables the user to achieve closed-loop gains of greater than 10, in both inverting and non-inverting configurations.

The LMH6624 (single) and LMH6626's (dual) traditional voltage feedback topology provide the following benefits: balanced inputs, low offset voltage and offset current, very low offset drift, 81dB open loop gain, 95dB common mode rejection ratio, and 88dB power supply rejection ratio.

The LMH6624/LMH6626 operate from $\pm 2.5\text{V}$ to $\pm 6\text{V}$ in dual supply mode and from $+5\text{V}$ to $+12\text{V}$ in single supply configuration.

LMH6624 is offered in SOT23-5 and SOIC-8 packages.

The LMH6626 is offered in SOIC-8 and MSOP-8 packages.

Features

$V_{\text{S}} = \pm 6\text{V}$, $T_{\text{A}} = 25^\circ\text{C}$, $A_{\text{V}} = 20$, (Typical values unless specified)

- | | |
|---|--------------------------------------|
| ■ Gain bandwidth (LMH6624) | 1.5GHz |
| ■ Input voltage noise | $0.92\text{nV}/\sqrt{\text{Hz}}$ |
| ■ Input offset voltage (limit over temp) | 700 μV |
| ■ Slew rate | 350V/ μs |
| ■ Slew rate ($A_{\text{V}} = 10$) | 400V/ μs |
| ■ HD2 @ $f = 10\text{MHz}$, $R_{\text{L}} = 100\Omega$ | -63dBc |
| ■ HD3 @ $f = 10\text{MHz}$, $R_{\text{L}} = 100\Omega$ | -80dBc |
| ■ Supply voltage range (dual supply) | $\pm 2.5\text{V}$ to $\pm 6\text{V}$ |
| ■ Supply voltage range (single supply) | $+5\text{V}$ to $+12\text{V}$ |
| ■ Improved replacement for the CLC425 (LMH6624) | |
| ■ Stable for closed loop $ A_{\text{V}} \geq 10$ | |

Applications

- Instrumentation sense amplifiers
- Ultrasound pre-amps
- Magnetic tape & disk pre-amps
- Wide band active filters
- Professional Audio Systems
- Opto-electronics
- Medical diagnostic systems

Connection Diagrams

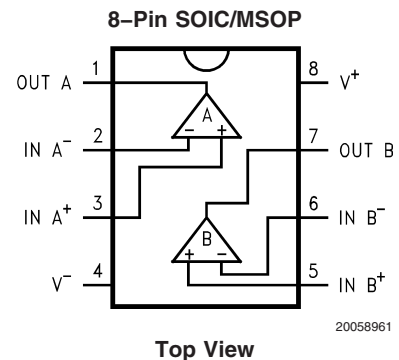
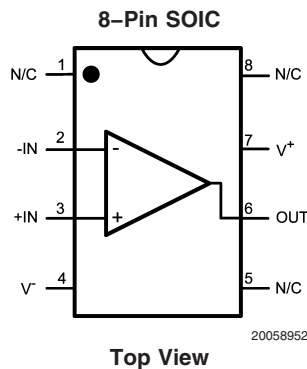
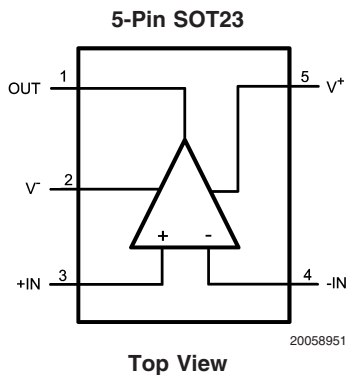

Absolute Maximum Ratings (Note 1)

If Military/Aerospace specified devices are required, please contact the National Semiconductor Sales Office/Distributors for availability and specifications.

| | |
|---|--|
| ESD Tolerance | |
| Human Body Model | 2000V (Note 2) |
| Machine Model | 200V (Note 9) |
| V _{IN} Differential | ±1.2V |
| Supply Voltage (V ⁺ - V ⁻) | 13.2V |
| Voltage at Input pins | V ⁺ +0.5V, V ⁻ -0.5V |
| Soldering Information | |
| Infrared or Convection (20 sec.) | 235°C |

| | |
|---|-----------------|
| Wave Soldering (10 sec.) | 260°C |
| Storage Temperature Range | -65°C to +150°C |
| Junction Temperature (Note 3), (Note 4) | +150°C |

Operating Ratings (Note 1)

| | |
|---|-----------------|
| Operating Temperature Range (Note 3), (Note 4) | -40°C to +125°C |
| Package Thermal Resistance (θ _{JA})(Note 4) | |
| SOIC-8 | 166°C/W |
| SOT23-5 | 265°C/W |
| MSOP-8 | 235°C/W |

±2.5V Electrical Characteristics

Unless otherwise specified, all limits guaranteed at T_A = 25°C, V⁺ = 2.5V, V⁻ = -2.5V, V_{CM} = 0V, A_V = +20, R_F = 500Ω, R_L = 100Ω. **Boldface** limits apply at the temperature extremes. See (Note 12).

| Symbol | Parameter | Conditions | Min (Note 6) | Typ (Note 5) | Max (Note 6) | Units |
|--------------------------------------|-------------------------------------|--|-----------------------|-----------------|-----------------------|--------|
| Dynamic Performance | | | | | | |
| f _{CL} | -3dB BW | V _O = 400mV _{PP} (LMH6624) | | 90 | | MHz |
| | | V _O = 400mV _{PP} (LMH6626) | | 80 | | |
| SR | Slew Rate(Note 8) | V _O = 2V _{PP} , A _V = +20 (LMH6624) | | 300 | | V/μs |
| | | V _O = 2V _{PP} , A _V = +20 (LMH6626) | | 290 | | |
| | | V _O = 2V _{PP} , A _V = +10 (LMH6624) | | 360 | | |
| | | V _O = 2V _{PP} , A _V = +10 (LMH6626) | | 340 | | |
| t _r | Rise Time | V _O = 400mV Step, 10% to 90% | | 4.1 | | ns |
| t _f | Fall Time | V _O = 400mV Step, 10% to 90% | | 4.1 | | ns |
| t _s | Settling Time 0.1% | V _O = 2V _{PP} (Step) | | 20 | | ns |
| Distortion and Noise Response | | | | | | |
| e _n | Input Referred Voltage Noise | f = 1MHz (LMH6624) | | 0.92 | | nV/√Hz |
| | | f = 1MHz (LMH6626) | | 1.0 | | |
| i _n | Input Referred Current Noise | f = 1MHz (LMH6624) | | 2.3 | | pA/√Hz |
| | | f = 1MHz (LMH6626) | | 1.8 | | |
| HD2 | 2 nd Harmonic Distortion | f _C = 10MHz, V _O = 1V _{PP} , R _L 100Ω | | -60 | | dBc |
| HD3 | 3 rd Harmonic Distortion | f _C = 10MHz, V _O = 1V _{PP} , R _L 100Ω | | -76 | | dBc |
| Input Characteristics | | | | | | |
| V _{OS} | Input Offset Voltage | V _{CM} = 0V | -0.75 -0.95 | -0.25 | +0.75 +0.95 | mV |
| | Average Drift (Note 7) | V _{CM} = 0V | | ±0.25 | | μV/°C |
| I _{OS} | Input Offset Current | V _{CM} = 0V | -1.5 -2.0 | -0.05 | +1.5 +2.0 | μA |
| | Average Drift (Note 7) | V _{CM} = 0V | | 2 | | nA/°C |
| I _B | Input Bias Current | V _{CM} = 0V | | 13 | +20 +25 | μA |
| | Average Drift (Note 7) | V _{CM} = 0V | | 12 | | nA/°C |
| R _{IN} | Input Resistance (Note 10) | Common Mode | | 6.6 | | MΩ |
| | | Differential Mode | | 4.6 | | kΩ |
| C _{IN} | Input Capacitance (Note 10) | Common Mode | | 0.9 | | pF |
| | | Differential Mode | | 2.0 | | |
| CMRR | Common Mode Rejection Ratio | Input Referred, V _{CM} = -0.5 to +1.9V V_{CM} = -0.5 to +1.75V | 87 85 | 90 | | dB |

±2.5V Electrical Characteristics (Continued)

Unless otherwise specified, all limits guaranteed at $T_A = 25^\circ\text{C}$, $V^+ = 2.5\text{V}$, $V^- = -2.5\text{V}$, $V_{\text{CM}} = 0\text{V}$, $A_V = +20$, $R_F = 500\Omega$, $R_L = 100\Omega$. **Boldface** limits apply at the temperature extremes. See (Note 12).

| Symbol | Parameter | Conditions | Min (Note 6) | Typ (Note 5) | Max (Note 6) | Units |
|---------------------------------|------------------------------|--|---|-----------------|-----------------|------------------|
| Transfer Characteristics | | | | | | |
| A_{VOL} | Large Signal Voltage Gain | (LMH6624) $R_L = 100\Omega$, $V_O = -1\text{V}$ to $+1\text{V}$ | 75 70 | 79 | | dB |
| | | (LMH6626) $R_L = 100\Omega$, $V_O = -1\text{V}$ to $+1\text{V}$ | 72 67 | 79 | | |
| X_t | Crosstalk Rejection | $f = 1\text{MHz}$ (LMH6626) | | -75 | | dB |
| Output Characteristics | | | | | | |
| V_O | Output Swing | $R_L = 100\Omega$ | ± 1.1 ± 1.0 | ± 1.5 | | V |
| | | No Load | ± 1.4 ± 1.25 | ± 1.7 | | |
| R_O | Output Impedance | $f \leq 100\text{KHz}$ | | 10 | | $\text{m}\Omega$ |
| I_{SC} | Output Short Circuit Current | (LMH6624) Sourcing to Ground $\Delta V_{\text{IN}} = 200\text{mV}$ (Note 3), (Note 11) | 90 75 | 145 | | mA |
| | | (LMH6624) Sinking to Ground $\Delta V_{\text{IN}} = -200\text{mV}$ (Note 3), (Note 11) | 90 75 | 145 | | |
| | | (LMH6626) Sourcing to Ground $\Delta V_{\text{IN}} = 200\text{mV}$ (Note 3), (Note 11) | 60 50 | 120 | | |
| | | (LMH6626) Sinking to Ground $\Delta V_{\text{IN}} = -200\text{mV}$ (Note 3), (Note 11) | 60 50 | 120 | | |
| I_{OUT} | Output Current | (LMH6624) Sourcing, $V_O = +0.8\text{V}$ Sinking, $V_O = -0.8\text{V}$ | | 100 | | mA |
| | | (LMH6626) Sourcing, $V_O = +0.8\text{V}$ Sinking, $V_O = -0.8\text{V}$ | | 75 | | |
| Power Supply | | | | | | |
| PSRR | Power Supply Rejection Ratio | $V_S = \pm 2.0\text{V}$ to $\pm 3.0\text{V}$ | 82 80 | 90 | | dB |
| I_S | Supply Current (per channel) | No Load | | 11.4 | 16 18 | mA |

±6V Electrical Characteristics

Unless otherwise specified, all limits guaranteed at $T_A = 25^\circ\text{C}$, $V^+ = 6\text{V}$, $V^- = -6\text{V}$, $V_{\text{CM}} = 0\text{V}$, $A_V = +20$, $R_F = 500\Omega$, $R_L = 100\Omega$. **Boldface** limits apply at the temperature extremes. See (Note 12).

| Symbol | Parameter | Conditions | Min (Note 6) | Typ (Note 5) | Max (Note 6) | Units |
|----------------------------|--------------------|--|-----------------|-----------------|-----------------|------------------|
| Dynamic Performance | | | | | | |
| f_{CL} | -3dB BW | $V_O = 400\text{mV}_{\text{PP}}$ (LMH6624) | | 95 | | MHz |
| | | $V_O = 400\text{mV}_{\text{PP}}$ (LMH6626) | | 85 | | |
| SR | Slew Rate (Note 8) | $V_O = 2V_{\text{PP}}$, $A_V = +20$ (LMH6624) | | 350 | | V/ μs |
| | | $V_O = 2V_{\text{PP}}$, $A_V = +20$ (LMH6626) | | 320 | | |
| | | $V_O = 2V_{\text{PP}}$, $A_V = +10$ (LMH6624) | | 400 | | |
| | | $V_O = 2V_{\text{PP}}$, $A_V = +10$ (LMH6626) | | 360 | | |
| t_r | Rise Time | $V_O = 400\text{mV}$ Step, 10% to 90% | | 3.7 | | ns |

±6V Electrical Characteristics (Continued)

Unless otherwise specified, all limits guaranteed at $T_A = 25^\circ\text{C}$, $V^+ = 6\text{V}$, $V^- = -6\text{V}$, $V_{CM} = 0\text{V}$, $A_V = +20$, $R_F = 500\Omega$, $R_L = 100\Omega$. **Boldface** limits apply at the temperature extremes. See (Note 12).

| Symbol | Parameter | Conditions | Min (Note 6) | Typ (Note 5) | Max (Note 6) | Units |
|--------------------------------------|---|---|---|-----------------|---------------------|------------------------------|
| t_f | Fall Time | $V_O = 400\text{mV}$ Step, 10% to 90% | | 3.7 | | ns |
| t_s | Settling Time 0.1% | $V_O = 2V_{PP}$ (Step) | | 18 | | ns |
| Distortion and Noise Response | | | | | | |
| e_n | Input Referred Voltage Noise | $f = 1\text{MHz}$ (LMH6624) | | 0.92 | | $\text{nV}/\sqrt{\text{Hz}}$ |
| | | $f = 1\text{MHz}$ (LMH6626) | | 1.0 | | |
| i_n | Input Referred Current Noise | $f = 1\text{MHz}$ (LMH6624) | | 2.3 | | $\text{pA}/\sqrt{\text{Hz}}$ |
| | | $f = 1\text{MHz}$ (LMH6626) | | 1.8 | | |
| HD2 | 2 nd Harmonic Distortion | $f_C = 10\text{MHz}$, $V_O = 1V_{PP}$, $R_L = 100\Omega$ | | -63 | | dBc |
| HD3 | 3 rd Harmonic Distortion | $f_C = 10\text{MHz}$, $V_O = 1V_{PP}$, $R_L = 100\Omega$ | | -80 | | dBc |
| Input Characteristics | | | | | | |
| V_{OS} | Input Offset Voltage | $V_{CM} = 0\text{V}$ | -0.5 -0.7 | ± 0.10 | +0.5 +0.7 | mV |
| | Average Drift (Note 7) | $V_{CM} = 0\text{V}$ | | ± 0.2 | | $\mu\text{V}/^\circ\text{C}$ |
| I_{OS} | Input Offset Current Average Drift (Note 7) | (LMH6624) $V_{CM} = 0\text{V}$ | -1.1 -2.5 | 0.05 | 1.1 2.5 | μA |
| | | (LMH6626) $V_{CM} = 0\text{V}$ | -2.0 -2.5 | 0.1 | 2.0 2.5 | |
| | | $V_{CM} = 0\text{V}$ | | | 0.7 | |
| I_B | Input Bias Current | $V_{CM} = 0\text{V}$ | | 13 | +20 +25 | μA |
| | Average Drift (Note 7) | $V_{CM} = 0\text{V}$ | | 12 | | $\text{nA}/^\circ\text{C}$ |
| R_{IN} | Input Resistance (Note 10) | Common Mode | | 6.6 | | $\text{M}\Omega$ |
| | | Differential Mode | | 4.6 | | $\text{k}\Omega$ |
| C_{IN} | Input Capacitance (Note 10) | Common Mode | | 0.9 | | pF |
| | | Differential Mode | | 2.0 | | |
| CMRR | Common Mode Rejection Ratio | Input Referred, $V_{CM} = -4.5$ to $+5.25\text{V}$ $V_{CM} = -4.5$ to $+5.0\text{V}$ | 90 87 | 95 | | dB |
| Transfer Characteristics | | | | | | |
| A_{VOL} | Large Signal Voltage Gain | (LMH6624) $R_L = 100\Omega$, $V_O = -3\text{V}$ to $+3\text{V}$ | 77 72 | 81 | | dB |
| | | (LMH6626) $R_L = 100\Omega$, $V_O = -3\text{V}$ to $+3\text{V}$ | 74 70 | 80 | | |
| | | | | | | |
| X_t | Crosstalk Rejection | $f = 1\text{MHz}$ (LMH6626) | | -75 | | dB |
| Output Characteristics | | | | | | |
| V_O | Output Swing | (LMH6624) $R_L = 100\Omega$ | ± 4.4 ± 4.3 | ± 4.9 | | V |
| | | (LMH6624) No Load | ± 4.8 ± 4.65 | ± 5.2 | | |
| | | (LMH6626) $R_L = 100\Omega$ | ± 4.3 ± 4.2 | ± 4.8 | | |
| | | (LMH6626) No Load | ± 4.8 ± 4.65 | ± 5.2 | | |
| | | | | | | |
| R_O | Output Impedance | $f \leq 100\text{kHz}$ | | 10 | | $\text{m}\Omega$ |

±6V Electrical Characteristics (Continued)

Unless otherwise specified, all limits guaranteed at $T_A = 25^\circ\text{C}$, $V^+ = 6\text{V}$, $V^- = -6\text{V}$, $V_{CM} = 0\text{V}$, $A_V = +20$, $R_F = 500\Omega$, $R_L = 100\Omega$. **Boldface** limits apply at the temperature extremes. See (Note 12).

| Symbol | Parameter | Conditions | Min (Note 6) | Typ (Note 5) | Max (Note 6) | Units |
|---------------------|------------------------------|---|------------------|-----------------|-----------------|-------|
| I_{SC} | Output Short Circuit Current | (LMH6624) Sourcing to Ground $\Delta V_{IN} = 200\text{mV}$ (Note 3), (Note 11) | 100 85 | 156 | | mA |
| | | (LMH6624) Sinking to Ground $\Delta V_{IN} = -200\text{mV}$ (Note 3), (Note 11) | 100 85 | 156 | | |
| | | (LMH6626) Sourcing to Ground $\Delta V_{IN} = 200\text{mV}$ (Note 3), (Note 11) | 65 55 | 120 | | |
| | | (LMH6626) Sinking to Ground $\Delta V_{IN} = -200\text{mV}$ (Note 3), (Note 11) | 65 55 | 120 | | |
| I_{OUT} | Output Current | (LMH6624) Sourcing, $V_O = +4.3\text{V}$ Sinking, $V_O = -4.3\text{V}$ | | 100 | | mA |
| | | (LMH6626) Sourcing, $V_O = +4.3\text{V}$ Sinking, $V_O = -4.3\text{V}$ | | 80 | | |
| Power Supply | | | | | | |
| PSRR | Power Supply Rejection Ratio | $V_S = \pm 5.4\text{V}$ to $\pm 6.6\text{V}$ | 82 80 | 88 | | dB |
| I_S | Supply Current (per channel) | No Load | | 12 | 16 18 | mA |

Note 1: Absolute maximum ratings indicate limits beyond which damage to the device may occur. Operating Ratings indicate conditions for which the device is intended to be functional, but specific performance is not guaranteed. For guaranteed specifications and the test conditions, see the Electrical Characteristics.

Note 2: Human body model, $1.5\text{k}\Omega$ in series with 100pF .

Note 3: Applies to both single-supply and split-supply operation. Continuous short circuit operation at elevated ambient temperature can result in exceeding the maximum allowed junction temperature of 150°C .

Note 4: The maximum power dissipation is a function of $T_{J(MAX)}$, θ_{JA} , and T_A . The maximum allowable power dissipation at any ambient temperature is $P_D = (T_{J(MAX)} - T_A) / \theta_{JA}$. All numbers apply for packages soldered directly onto a PC board.

Note 5: Typical Values represent the most likely parametric norm.

Note 6: All limits are guaranteed by testing or statistical analysis.

Note 7: Average drift is determined by dividing the change in parameter at temperature extremes into the total temperature change.

Note 8: Slew rate is the slowest of the rising and falling slew rates.

Note 9: Machine Model, 0Ω in series with 200pF .

Note 10: Simulation results.

Note 11: Short circuit test is a momentary test. Output short circuit duration is 1.5ms .

Note 12: Electrical table values apply only for factory testing conditions at the temperature indicated. Factory testing conditions result in very limited self-heating of the device such that $T_J = T_A$. No guarantee of parametric performance is indicated in the electrical tables under conditions of internal self-heating where $T_J > T_A$. Absolute maximum ratings indicate junction temperature limits beyond which the device may be permanently degraded, either mechanically or electrically.

Ordering Information

| Package | Part Number | Package Marking | Transport Media | NSC Drawing |
|---------|-------------|-----------------|--------------------------|-------------|
| SOT23-5 | LMH6624MF | A94A | 1k Units Tape and Reel | MF05A |
| | LMH6624MFX | | 3k Units Tape and Reel | |
| SOIC-8 | LMH6624MA | LMH6624MA | 95 Units/Rail | M08A |
| | LMH6624MAX | | 2.5k Units Tape and Reel | |
| SOIC-8 | LMH6626MA | LMH6626MA | 95 Units/Rail | M08A |
| | LMH6626MAX | | 2.5k Units Tape and Reel | |
| MSOP-8 | LMH6626MM | A98A | 1k Units Tape and Reel | MUA08A |
| | LMH6626MMX | | 3.5k Units Tape and Reel | |

Typical Performance Characteristics

Voltage Noise vs. Frequency

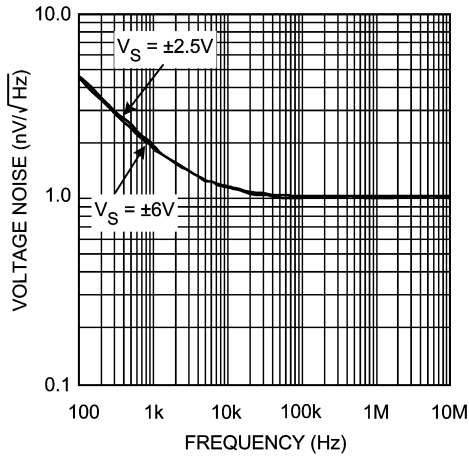

20058962

Current Noise vs. Frequency

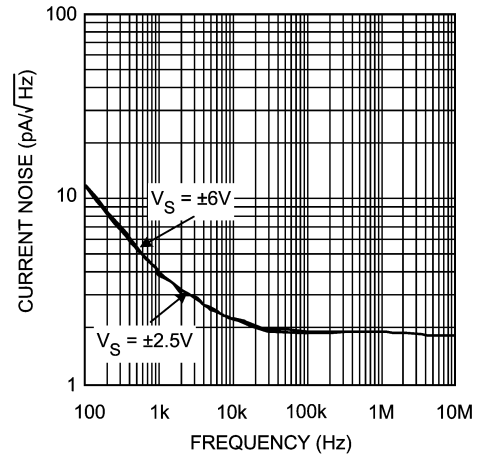

20058963

Inverting Frequency Response

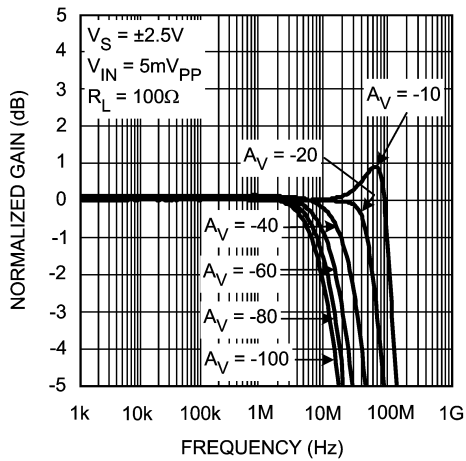

20058989

Inverting Frequency Response

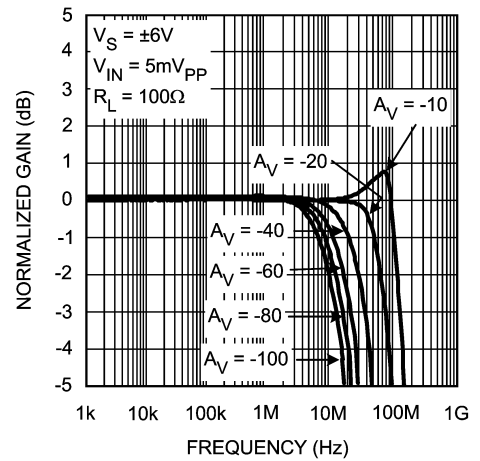

20058988

Non-Inverting Frequency Response

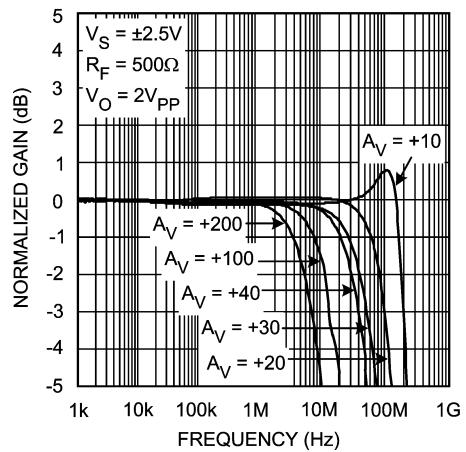

20058904

Non-Inverting Frequency Response

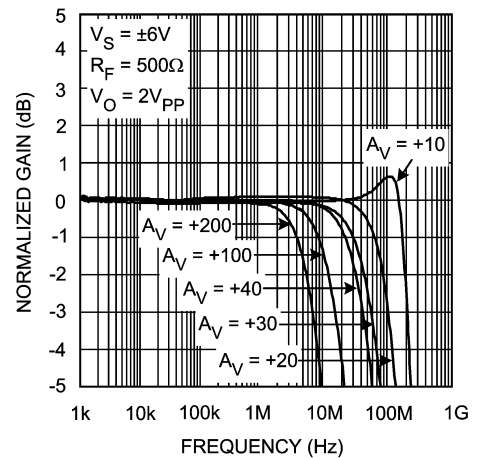

20058903

Typical Performance Characteristics (Continued)

Open Loop Frequency Response Over Temperature

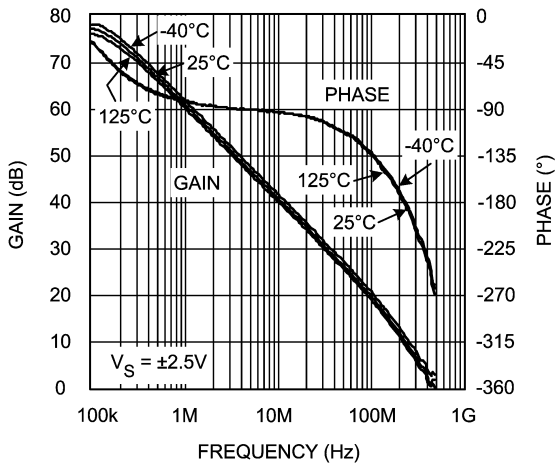

20058966

Open Loop Frequency Response Over Temperature

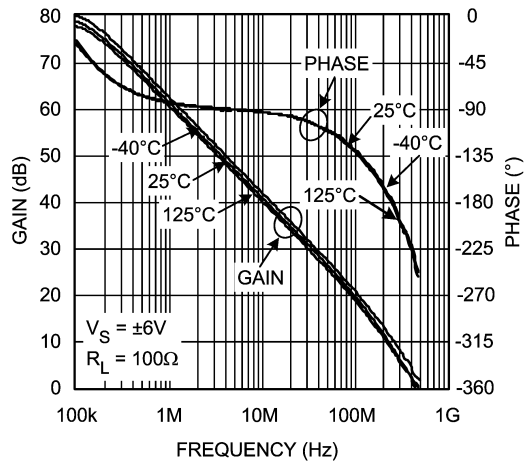

20058964

Frequency Response with Cap. Loading

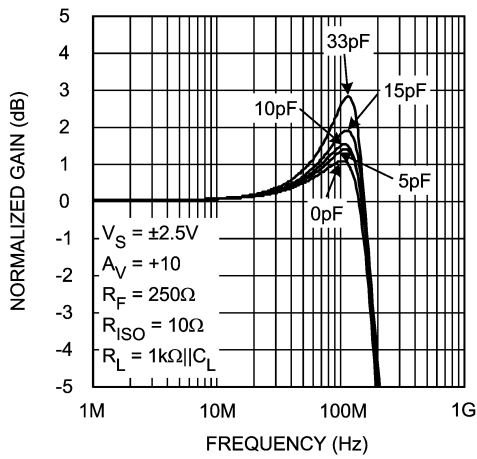

20058984

Frequency Response with Cap. Loading

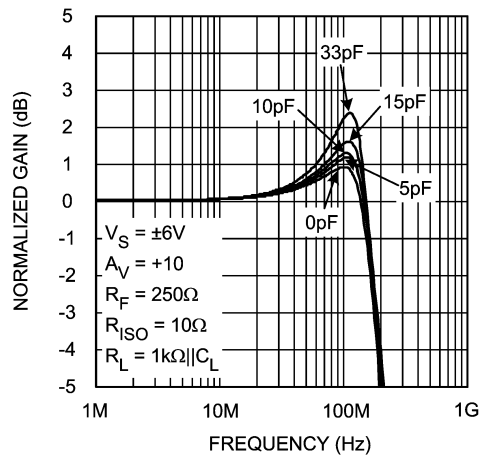

20058986

Frequency Response with Cap. Loading

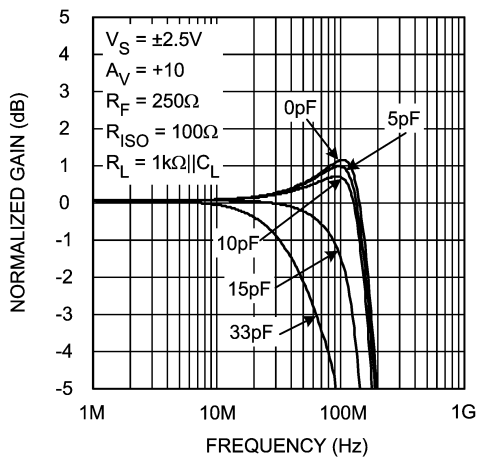

20058987

Frequency Response with Cap. Loading

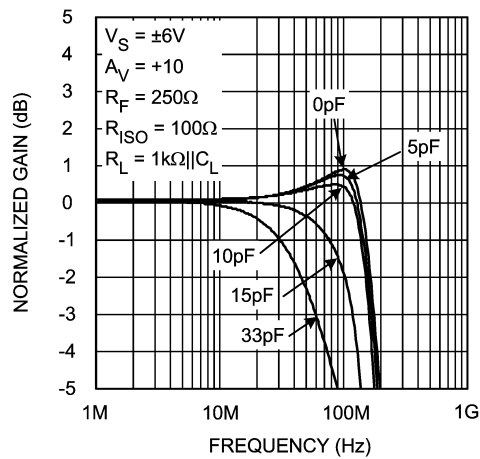

20058985

Typical Performance Characteristics (Continued)

Non-Inverting Frequency Response Varying V_{IN}

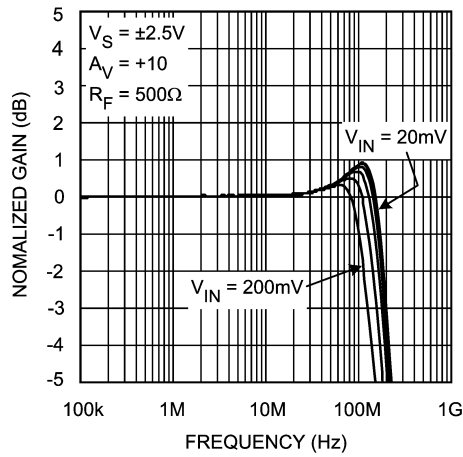

20058906

Non-Inverting Frequency Response Varying V_{IN}

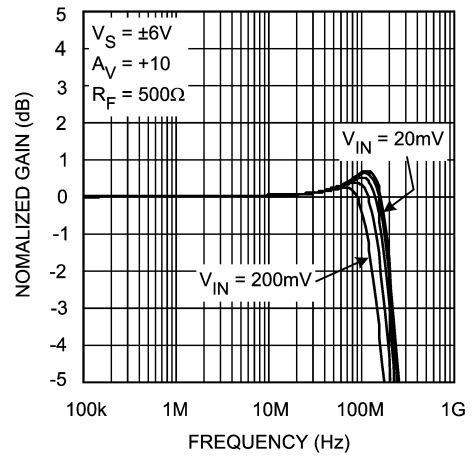

20058905

Non-Inverting Frequency Response Varying V_{IN} (LMH6624)

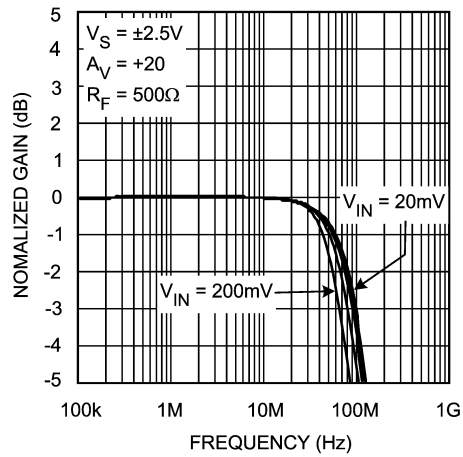

20058908

Non-Inverting Frequency Response Varying V_{IN} (LMH6626)

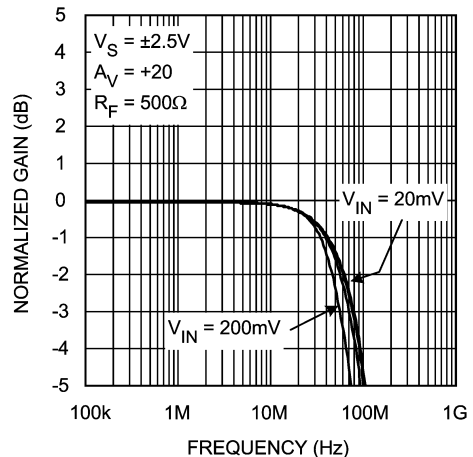

20058981

Non-Inverting Frequency Response Varying V_{IN} (LMH6624)

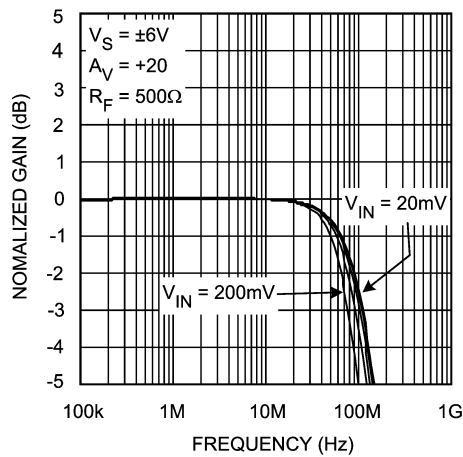

20058907

Non-Inverting Frequency Response Varying V_{IN} (LMH6626)

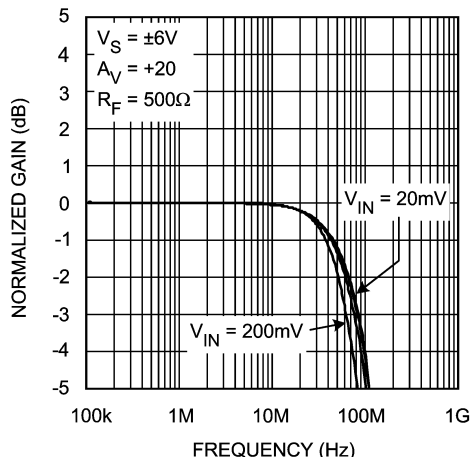

20058980

Typical Performance Characteristics (Continued)

Sourcing Current vs. V_{OUT} (LMH6624)

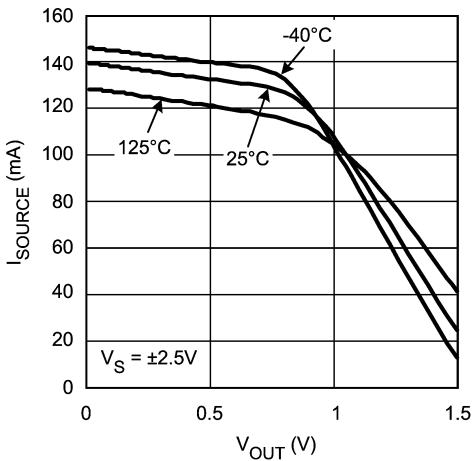

20058957

Sourcing Current vs. V_{OUT} (LMH6626)

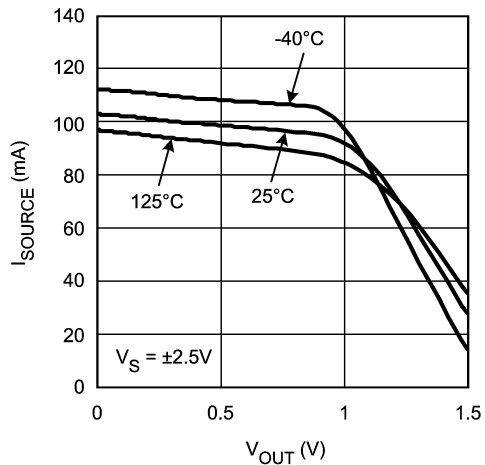

20058972

Sourcing Current vs. V_{OUT} (LMH6624)

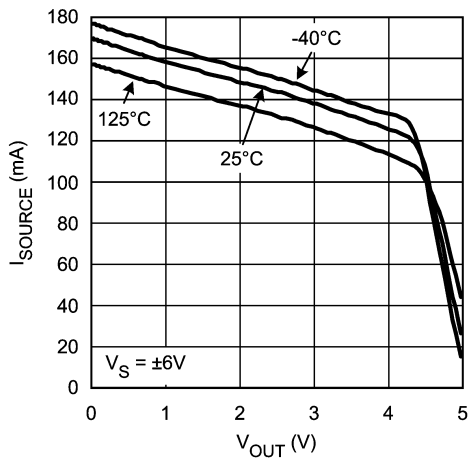

20058954

Sourcing Current vs. V_{OUT} (LMH6626)

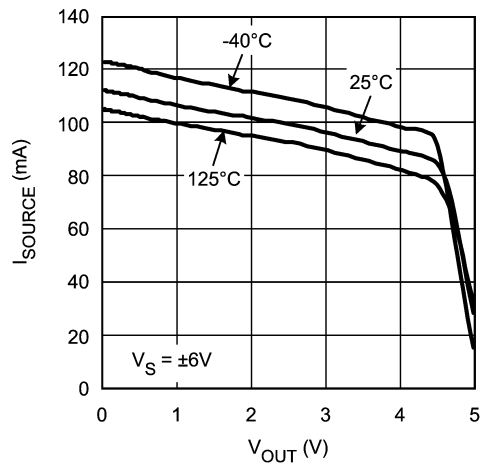

20058969

V_{OS} vs. V_{SUPPLY} (LMH6624)

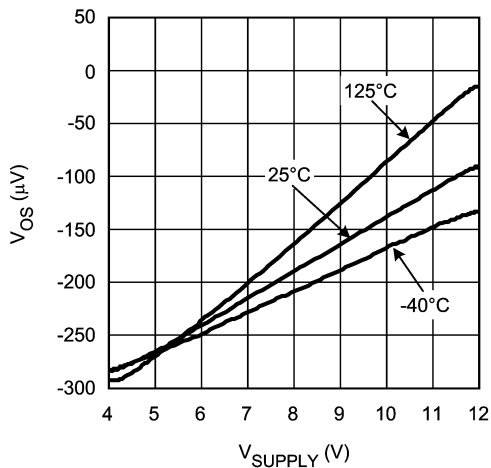

20058967

V_{OS} vs. V_{SUPPLY} (LMH6626)

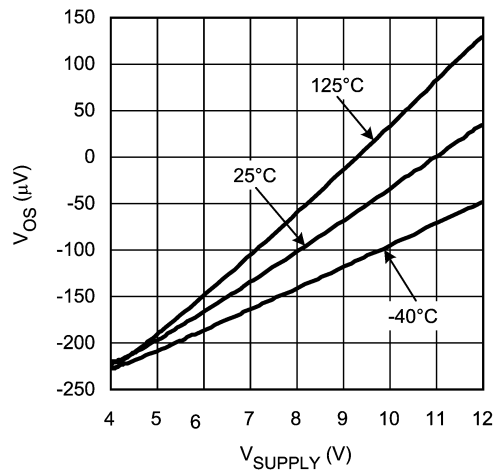

20058968

Typical Performance Characteristics (Continued)

Sinking Current vs. V_{OUT} (LMH6624)

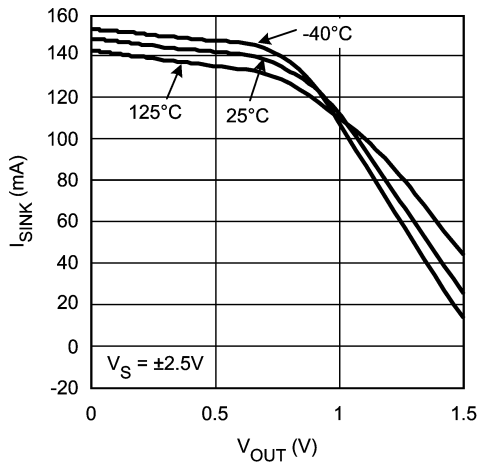

20058958

Sinking Current vs. V_{OUT} (LMH6626)

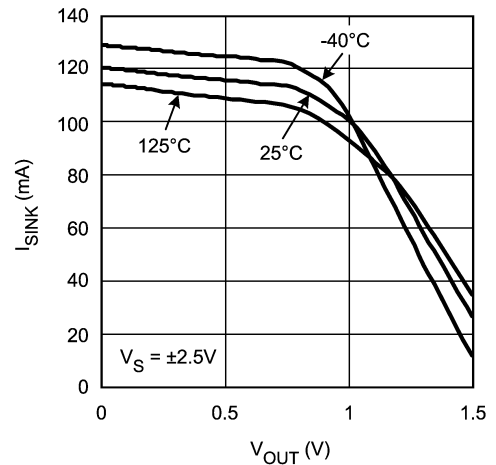

20058971

Sinking Current vs. V_{OUT} (LMH6624)

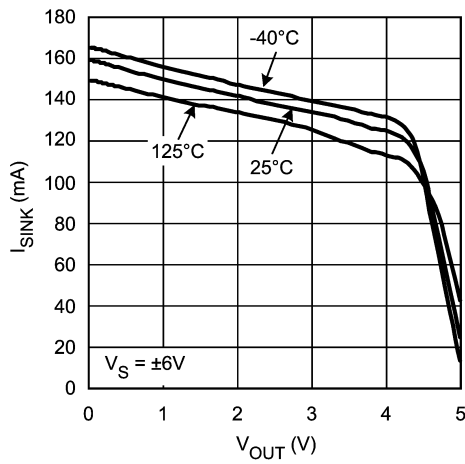

20058956

Sinking Current vs. V_{OUT} (LMH6626)

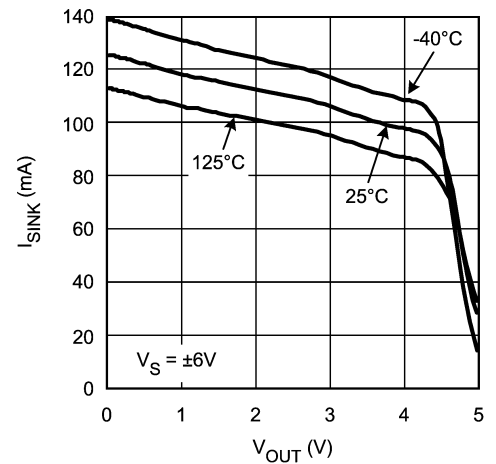

20058970

I_{OS} vs. V_{SUPPLY}

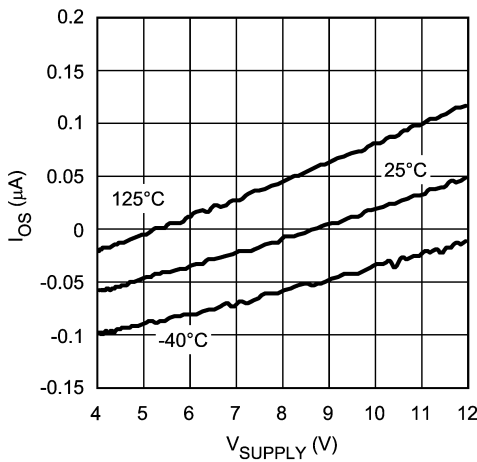

20058953

Crosstalk Rejection vs. Frequency (LMH6626)

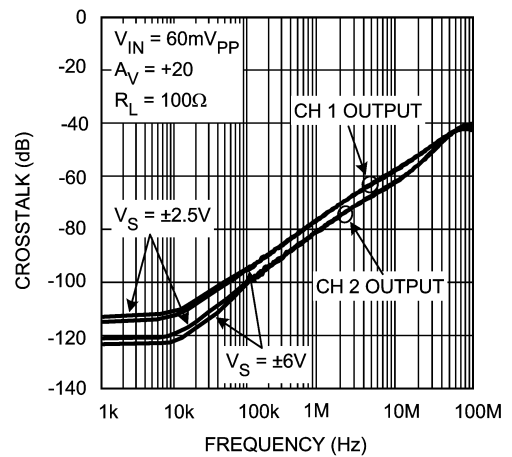

20058979

Typical Performance Characteristics (Continued)

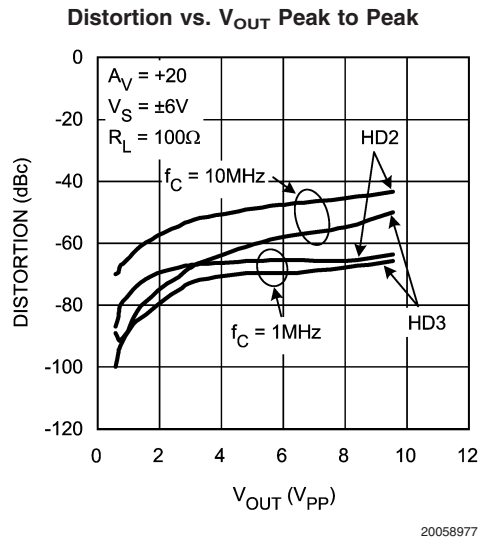
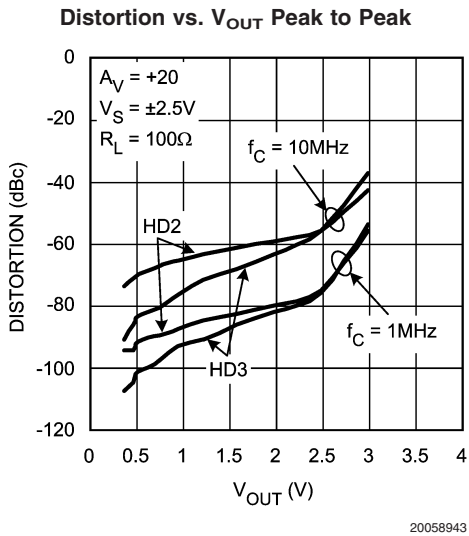
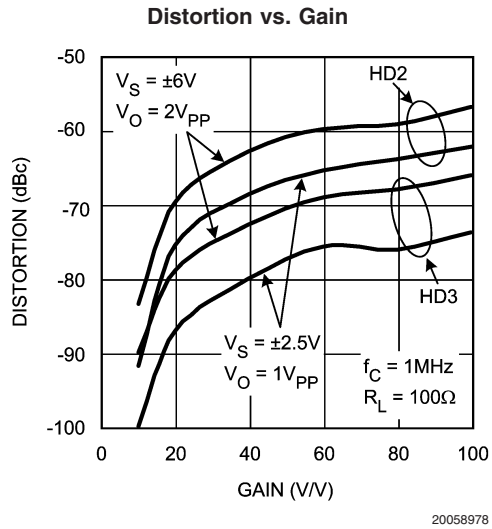
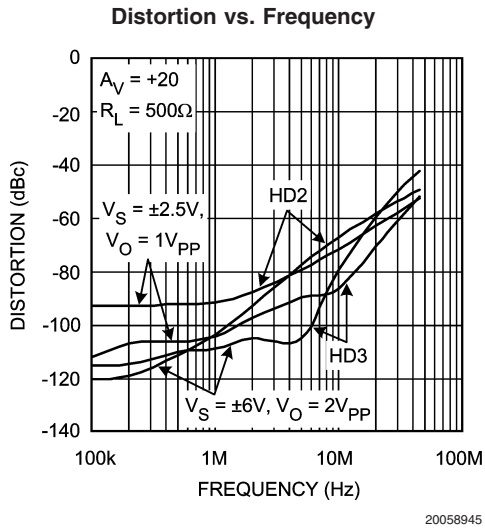
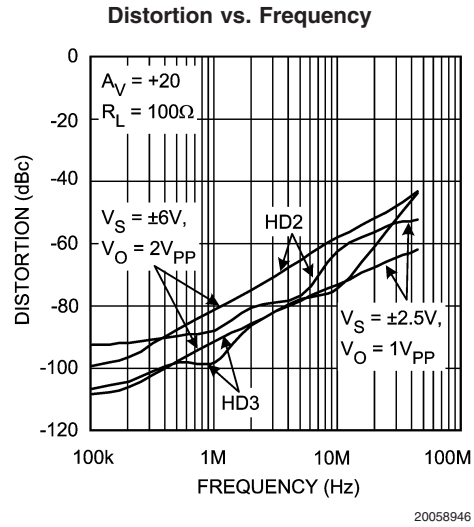
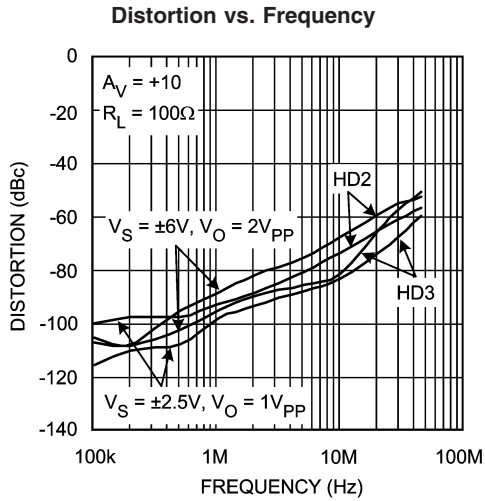

Typical Performance Characteristics (Continued)

Non-Inverting Large Signal Pulse Response

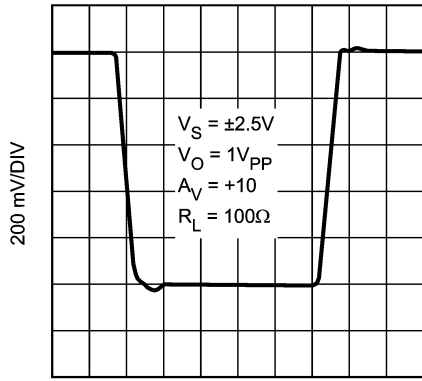

10 ns/DIV

20058973

Non-Inverting Large Signal Pulse Response

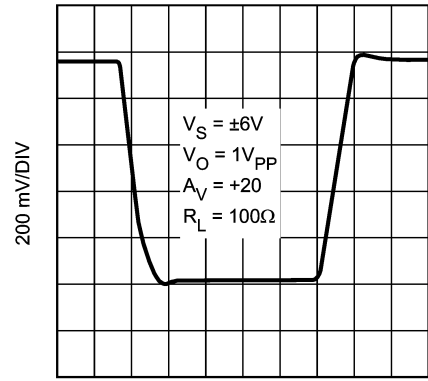

10 ns/DIV

20058974

Non-Inverting Small Signal Pulse Response

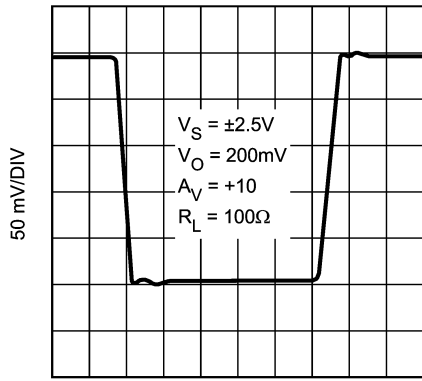

10 ns/DIV

20058975

Non-Inverting Small Signal Pulse Response

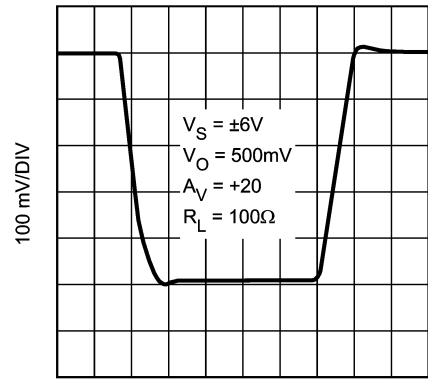

10 ns/DIV

20058976

PSRR vs. Frequency

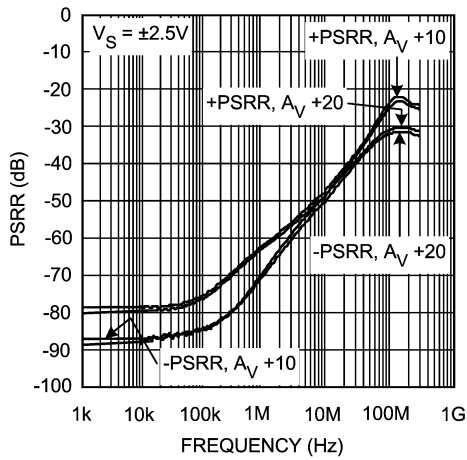

20058948

PSRR vs. Frequency

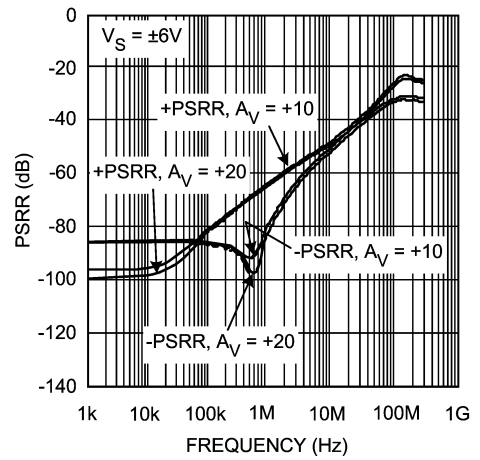

20058949

Typical Performance Characteristics (Continued)

Input Referred CMRR vs. Frequency

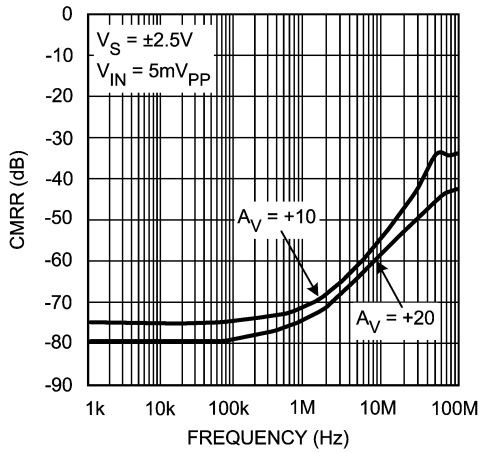

20058901

Input Referred CMRR vs. Frequency

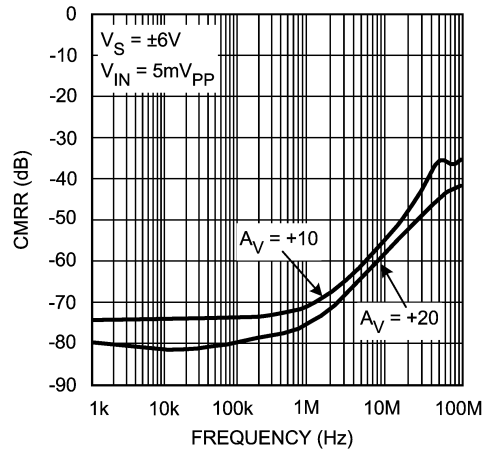

20058902

Amplifier Peaking with Varying R_F

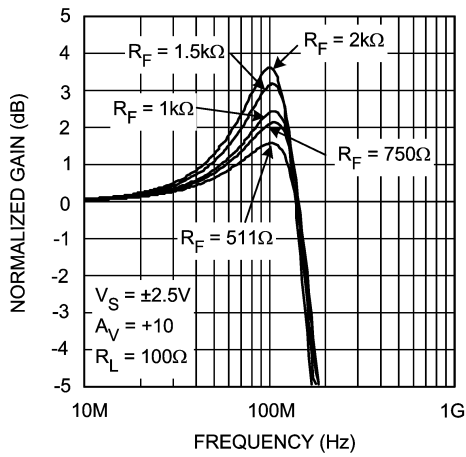

20058983

Amplifier Peaking with Varying R_F

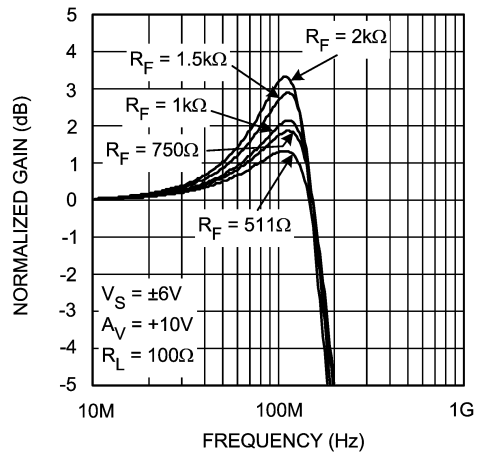

20058982

Application Section

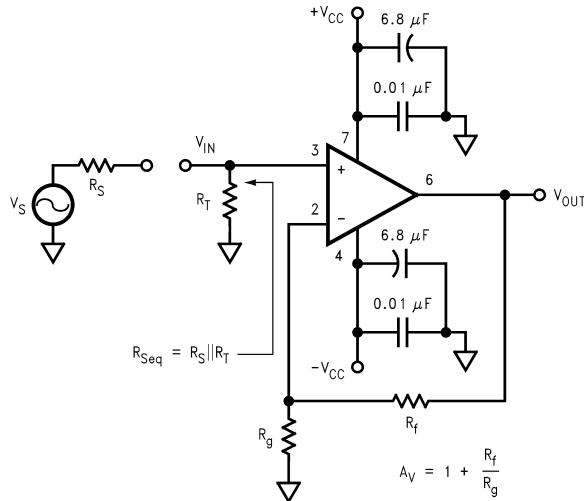

20058918

FIGURE 1. Non-Inverting Amplifier Configuration

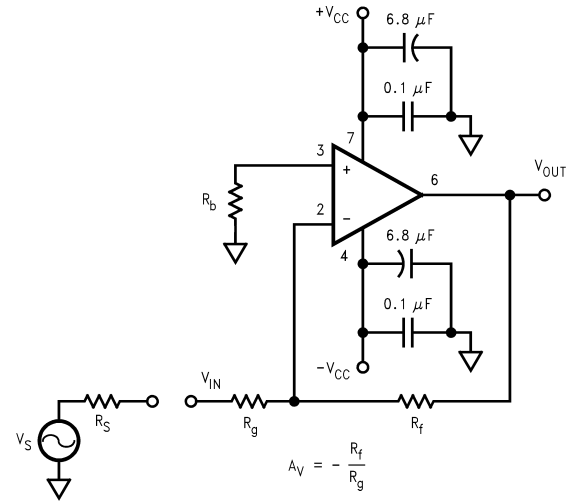

20058919

FIGURE 2. Inverting Amplifier Configuration

INTRODUCTION

The LMH6624/LMH6626 are very wide gain bandwidth, ultra low noise voltage feedback operational amplifiers. Their excellent performances enable applications such as medical diagnostic ultrasound, magnetic tape & disk storage and fiber-optics to achieve maximum high frequency signal-to-noise ratios. The set of characteristic plots in the "Typical Performance" section illustrates many of the performance trade offs. The following discussion will enable the proper selection of external components to achieve optimum system performance.

BIAS CURRENT CANCELLATION

To cancel the bias current errors of the non-inverting configuration, the parallel combination of the gain setting (R_g) and feedback (R_f) resistors should equal the equivalent source resistance (R_{seq}) as defined in Figure 1. Combining this constraint with the non-inverting gain equation also seen in Figure 1, allows both R_f and R_g to be determined explicitly from the following equations:

$$R_f = A_V R_{seq} \text{ and } R_g = R_f / (A_V - 1)$$

When driven from a 0Ω source, such as the output of an op amp, the non-inverting input of the LMH6624/LMH6626 should be isolated with at least a 25Ω series resistor.

As seen in Figure 2, bias current cancellation is accomplished for the inverting configuration by placing a resistor (R_b) on the non-inverting input equal in value to the resistance seen by the inverting input ($R_f || (R_g + R_s)$). R_b should be no less than 25Ω for optimum LMH6624/LMH6626 performance. A shunt capacitor can minimize the additional noise of R_b .

TOTAL INPUT NOISE vs. SOURCE RESISTANCE

To determine maximum signal-to-noise ratios from the LMH6624/LMH6626, an understanding of the interaction between the amplifier's intrinsic noise sources and the noise arising from its external resistors is necessary.

Figure 3 describes the noise model for the non-inverting amplifier configuration showing all noise sources. In addition to the intrinsic input voltage noise (e_n) and current noise ($i_n = i_{n+} = i_{n-}$) source, there is also thermal voltage noise ($e_t = \sqrt{4KTR}$) associated with each of the external resistors. Equation 1 provides the general form for total equivalent input voltage noise density (e_{ni}). Equation 2 is a simplification of Equation 1 that assumes

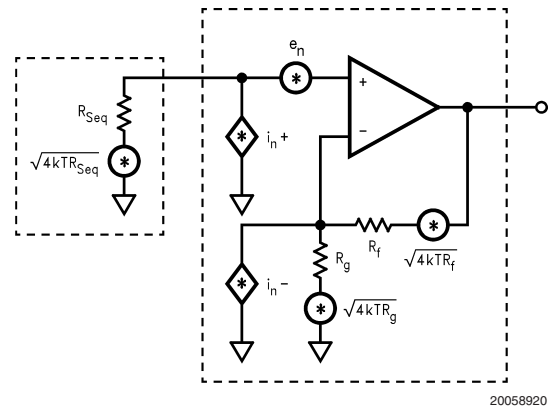

20058920

FIGURE 3. Non-Inverting Amplifier Noise Model

Application Section (Continued)

$$e_{ni} = \sqrt{e_n^2 + (i_n + R_{Seq})^2 + 4kTR_{Seq} + (i_n - (R_f || R_g))^2 + 4kT(R_f || R_g)} \quad (1)$$

$R_f || R_g = R_{Seq}$ for bias current cancellation. *Figure 4* illustrates the equivalent noise model using this assumption. *Figure 5* is a plot of e_{ni} against equivalent source resistance (R_{Seq}) with all of the contributing voltage noise source of Equation 2. This plot gives the expected e_{ni} for a given (R_{Seq}) which assumes $R_f || R_g = R_{Seq}$ for bias current cancellation. The total equivalent output voltage noise (e_{no}) is $e_{ni} \cdot A_V$.

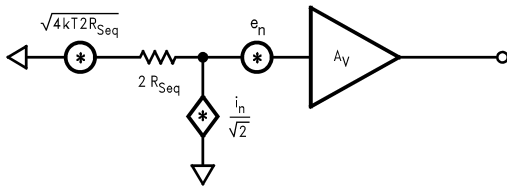

20058921

FIGURE 4. Noise Model with $R_f || R_g = R_{Seq}$

$$e_{ni} = \sqrt{e_n^2 + 2(i_n R_{Seq})^2 + 4kT(2R_{Seq})} \quad (2)$$

As seen in *Figure 5*, e_{ni} is dominated by the intrinsic voltage noise (e_n) of the amplifier for equivalent source resistances below 33.5Ω . Between 33.5Ω and $6.43k\Omega$, e_{ni} is dominated by the thermal noise ($e_t = \sqrt{4kT(2R_{Seq})}$) of the external resistor. Above $6.43k\Omega$, e_{ni} is dominated by the amplifier's current noise ($i_n = \sqrt{2} i_{nR_{Seq}}$). When $R_{Seq} = 464\Omega$ (ie., $e_n / \sqrt{2} i_n$) the contribution from voltage noise and current noise of LMH6624/LMH6626 is equal. For example, configured with a gain of $+20V/V$ giving a $-3dB$ of $90MHz$ and driven from $R_{Seq} = 25\Omega$, the LMH6624 produces a total equivalent input noise voltage ($e_{ni} \times \sqrt{Hz} \cdot 1.57 \cdot 90MHz$) of $16.5\mu V_{rms}$.

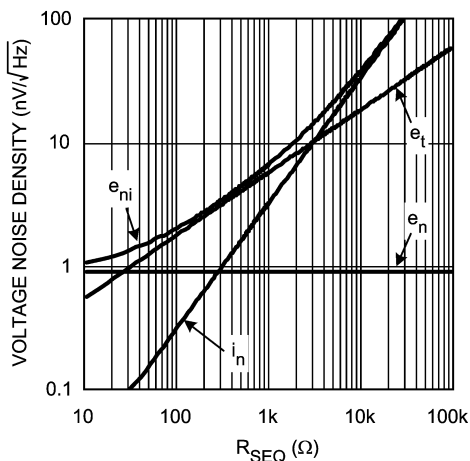

20058922

FIGURE 5. Voltage Noise Density vs. Source Resistance

If bias current cancellation is not a requirement, then $R_f || R_g$ need not equal R_{Seq} . In this case, according to Equation 1,

$R_f || R_g$ should be as low as possible to minimize noise. Results similar to Equation 1 are obtained for the inverting configuration of *Figure 2* if R_{Seq} is replaced by R_b and R_g is replaced by $R_g + R_s$. With these substitutions, Equation 1 will yield an e_{ni} referred to the non-inverting input. Referring e_{ni} to the inverting input is easily accomplished by multiplying e_{ni} by the ratio of non-inverting to inverting gains.

NOISE FIGURE

Noise Figure (NF) is a measure of the noise degradation caused by an amplifier.

$$NF = 10 \text{LOG} \left\{ \frac{S_i / N_i}{S_o / N_o} \right\} = 10 \text{LOG} \left\{ \frac{e_{ni}^2}{e_t^2} \right\} \quad (3)$$

The Noise Figure formula is shown in Equation 3. The addition of a terminating resistor R_T , reduces the external thermal noise but increases the resulting NF. The NF is increased because R_T reduces the input signal amplitude thus reducing the input SNR.

$$NF = 10 \text{LOG} \left[\frac{e_n^2 + i_n^2 (R_{Seq}^2 + (R_f || R_g)^2) + 4kT(R_{Seq} + (R_f || R_g))}{4kT(R_{Seq} + (R_f || R_g))} \right] \quad (4)$$

The noise figure is related to the equivalent source resistance (R_{Seq}) and the parallel combination of R_f and R_g . To minimize noise figure.

- Minimize $R_f || R_g$
- Choose the Optimum R_S (R_{OPT})

R_{OPT} is the point at which the NF curve reaches a minimum and is approximated by:

$$R_{OPT} \approx e_n / i_n$$

SINGLE SUPPLY OPERATION

The LMH6624/LMH6626 can be operated with single power supply as shown in *Figure 6*. Both the input and output are capacitively coupled to set the DC operating point.

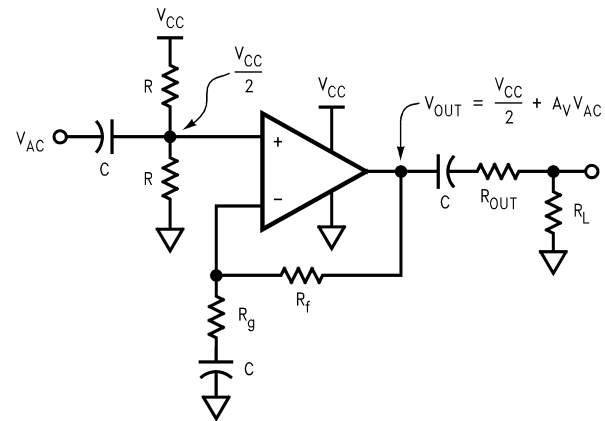

20058926

FIGURE 6. Single Supply Operation

LOW NOISE TRANSMIMPEDANCE AMPLIFIER

Figure 7 implements a low-noise transimpedance amplifier commonly used with photo-diodes. The transimpedance gain is set by R_f . Equation 4 provides the total input current

Application Section (Continued)

noise density (i_{ni}) equation for the basic transimpedance configuration and is plotted against feedback resistance (R_f) showing all contributing noise sources in *Figure 8*. This plot indicates the expected total equivalent input current noise density (i_{ni}) for a given feedback resistance (R_f). The total equivalent output voltage noise density (e_{no}) is $i_{ni} * R_f$.

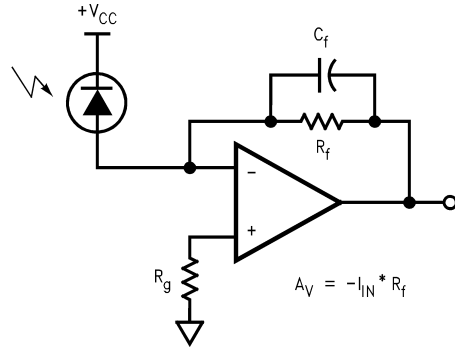

20058927

FIGURE 7. Transimpedance Amplifier Configuration

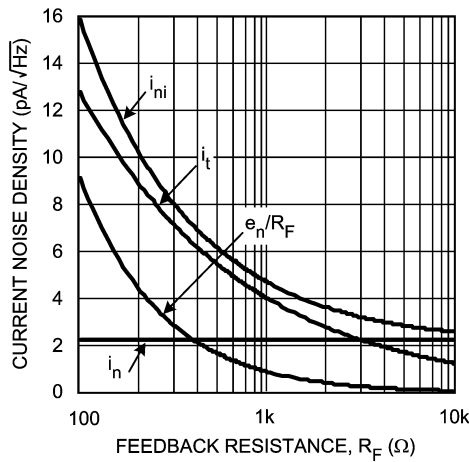

20058928

FIGURE 8. Current Noise Density vs. Feedback Resistance

$$i_{ni} = \sqrt{i_n^2 + \left(\frac{e_n}{R_f}\right)^2 + \frac{4kT}{R_f}} \quad (5)$$

LOW NOISE INTEGRATOR

The LMH6624/LMH6626 implement a deBoo integrator shown in *Figure 9*. Positive feedback maintains integration linearity. The LMH6624/LMH6626's low input offset voltage and matched inputs allow bias current cancellation and provide for very precise integration. Keeping R_G and R_S low helps maintain dynamic stability.

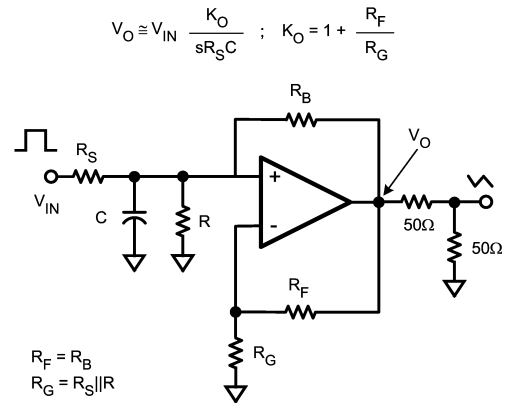

20058929

FIGURE 9. Low Noise Integrator

HIGH-GAIN Sallen-Key ACTIVE FILTERS

The LMH6624/LMH6626 are well suited for high gain Sallen-Key type of active filters. *Figure 10* shows the 2nd order Sallen-Key low pass filter topology. Using component predistortion methods discussed in OA-21 enables the proper selection of components for these high-frequency filters.

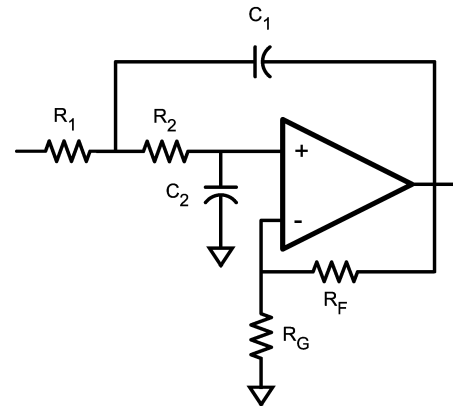

20058930

FIGURE 10. Sallen-Key Active Filter Topology

LOW NOISE MAGNETIC MEDIA EQUALIZER

The LMH6624/LMH6626 implement a high-performance low noise equalizer for such application as magnetic tape channels as shown in *Figure 11*. The circuit combines an integrator with a bandpass filter to produce the low noise equalization. The circuit's simulated frequency response is illustrated in *Figure 12*.

Application Section (Continued)

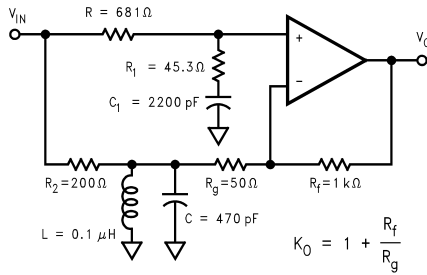

$$\frac{V_O}{V_{IN}} = K_0 \left(\frac{sC_1 R_1 + 1}{sC_1 (R_1 + R) + 1} - \left(\frac{R_f}{R_f + R_g} \right) \frac{sLR_g}{s^2 LCR_2 R_g + sL(R_2 + R_g) + R_2 R_g} \right)$$

20058931

FIGURE 11. Noise Magnetic Media Equalizer

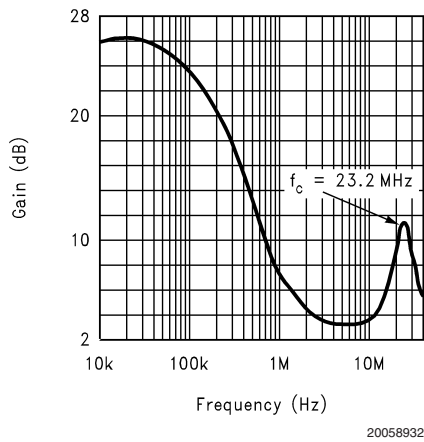

FIGURE 12. Equalizer Frequency Response

LAYOUT CONSIDERATION

National Semiconductor suggests the copper patterns on the evaluation boards listed below as a guide for high frequency layout. These boards are also useful as an aid in device testing and characterization. As is the case with all high-speed amplifiers, accepted-practice RF design technique on

the PCB layout is mandatory. Generally, a good high frequency layout exhibits a separation of power supply and ground traces from the inverting input and output pins. Parasitic capacitances between these nodes and ground may cause frequency response peaking and possible circuit oscillations (see Application Note OA-15 for more information). Use high quality chip capacitors with values in the range of 1000pF to 0.1F for power supply bypassing. One terminal of each chip capacitor is connected to the ground plane and the other terminal is connected to a point that is as close as possible to each supply pin as allowed by the manufacturer's design rules. In addition, connect a tantalum capacitor with a value between 4.7μF and 10μF in parallel with the chip capacitor. Signal lines connecting the feedback and gain resistors should be as short as possible to minimize inductance and microstrip line effect. Place input and output termination resistors as close as possible to the input/output pins. Traces greater than 1 inch in length should be impedance matched to the corresponding load termination.

Symmetry between the positive and negative paths in the layout of differential circuitry should be maintained to minimize the imbalance of amplitude and phase of the differential signal.

These free evaluation boards are shipped when a device sample request is placed with National Semiconductor.

Component value selection is another important parameter in working with high speed/high performance amplifiers. Choosing external resistors that are large in value compared to the value of other critical components will affect the closed loop behavior of the stage because of the interaction of these resistors with parasitic capacitances. These parasitic capacitors could either be inherent to the device or be a by-product of the board layout and component placement. Moreover, a large resistor will also add more thermal noise to the signal path. Either way, keeping the resistor values low will diminish this interaction. On the other hand, choosing very low value resistors could load down nodes and will contribute to higher overall power dissipation and high distortion.

| Device | Package | Evaluation Board Part Number |
|-----------|---------|------------------------------|
| LMH6624MF | SOT23-5 | CLC730216 |
| LMH6624MA | SOIC-8 | CLC730227 |
| LMH6626MA | SOIC-8 | CLC730036 |
| LMH6626MM | MSOP-8 | CLC730123 |

Physical Dimensions inches (millimeters) unless otherwise noted

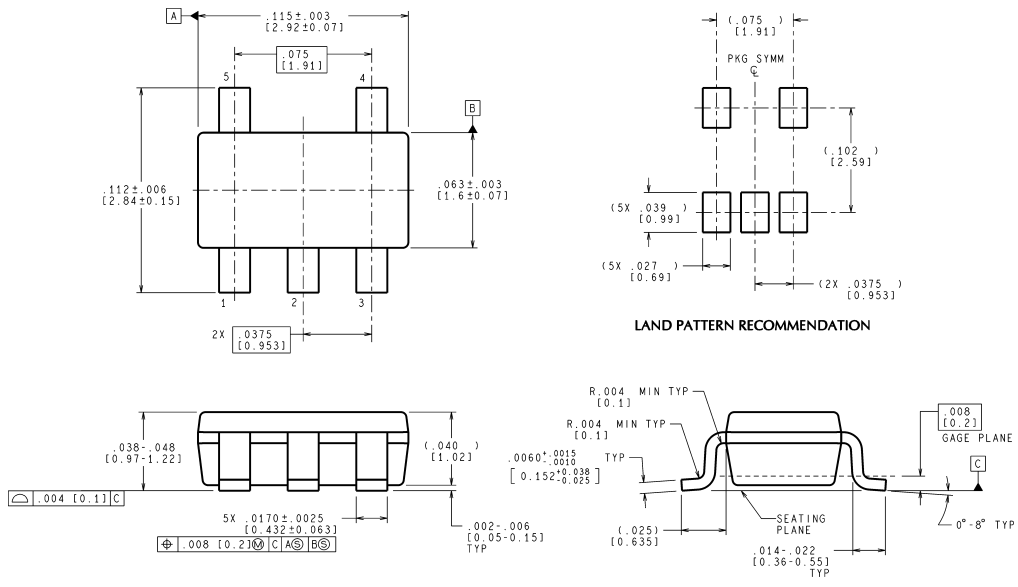

CONTROLLING DIMENSION IS INCH
VALUES IN [] ARE MILLIMETERS

MF05A (Rev B)

5-Pin SOT23
NS Package Number MF05A

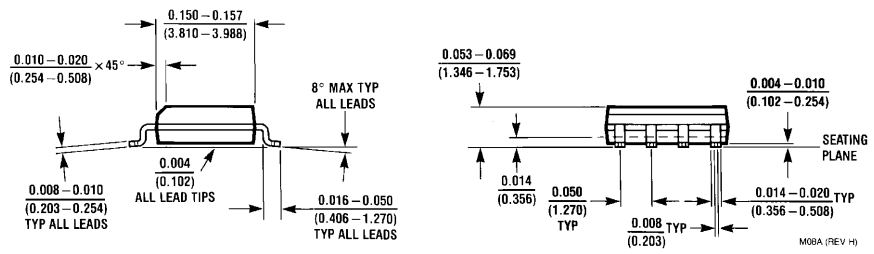
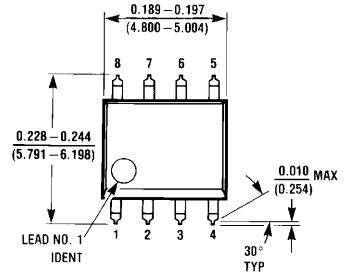

8-Pin SOIC
NS Package Number M08A

Physical Dimensions inches (millimeters) unless otherwise noted (Continued)

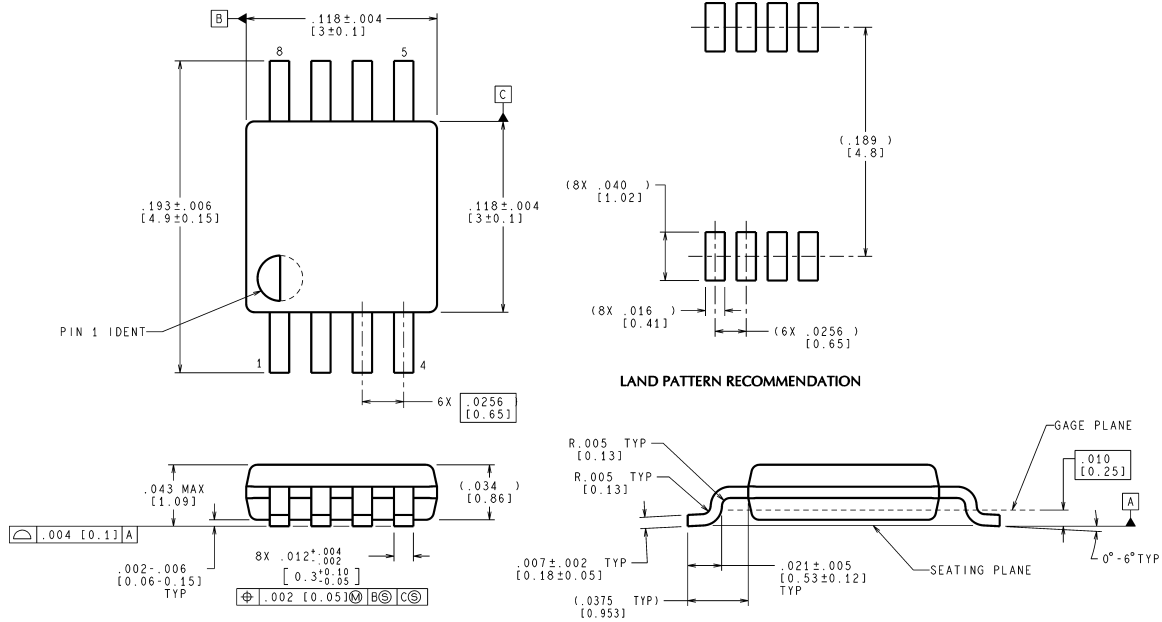

CONTROLLING DIMENSION IS INCH
VALUES IN [] ARE MILLIMETERS

MUA08A (Rev E)

8-Pin MSOP
NS Package Number MUA08A

National does not assume any responsibility for use of any circuitry described, no circuit patent licenses are implied and National reserves the right at any time without notice to change said circuitry and specifications.
For the most current product information visit us at www.national.com.

LIFE SUPPORT POLICY

NATIONAL'S PRODUCTS ARE NOT AUTHORIZED FOR USE AS CRITICAL COMPONENTS IN LIFE SUPPORT DEVICES OR SYSTEMS WITHOUT THE EXPRESS WRITTEN APPROVAL OF THE PRESIDENT AND GENERAL COUNSEL OF NATIONAL SEMICONDUCTOR CORPORATION. As used herein:

1. Life support devices or systems are devices or systems which, (a) are intended for surgical implant into the body, or (b) support or sustain life, and whose failure to perform when properly used in accordance with instructions for use provided in the labeling, can be reasonably expected to result in a significant injury to the user.
2. A critical component is any component of a life support device or system whose failure to perform can be reasonably expected to cause the failure of the life support device or system, or to affect its safety or effectiveness.

BANNED SUBSTANCE COMPLIANCE

National Semiconductor manufactures products and uses packing materials that meet the provisions of the Customer Products Stewardship Specification (CSP-9-111C2) and the Banned Substances and Materials of Interest Specification (CSP-9-111S2) and contain no "Banned Substances" as defined in CSP-9-111S2.

Leadfree products are RoHS compliant.



National Semiconductor
Americas Customer Support Center
Email: new.feedback@nsc.com
Tel: 1-800-272-9959

National Semiconductor
Europe Customer Support Center
Fax: +49 (0) 180-530 85 86
Email: europa.support@nsc.com
Deutsch Tel: +49 (0) 69 9508 6208
English Tel: +44 (0) 870 24 0 2171
Français Tel: +33 (0) 1 41 91 8790

National Semiconductor
Asia Pacific Customer Support Center
Email: ap.support@nsc.com

National Semiconductor
Japan Customer Support Center
Fax: 81-3-5639-7507
Email: jpn.feedback@nsc.com
Tel: 81-3-5639-7560