

LM73605/LM73606 3.5-V to 36-V, 5-A or 6-A Synchronous Step-Down Voltage Converter

1 Features

- Synchronous Rectification
- Wettable Flanks QFN Package (WQFN)
- Low Quiescent Current
 - 0.8 μA in Shutdown (typical)
 - 15 μA in Active Mode with No Load (typical)
- Wide Voltage Conversion Range:
 - $t_{\text{ON_MIN}} = 60 \text{ ns}$ (typical)
 - $t_{\text{OFF_MIN}} = 70 \text{ ns}$ (typical)
- Low MOSFET ON-Resistance:
 - $R_{\text{DS_ON_HS}} = 53 \text{ m}\Omega$ (typical)
 - $R_{\text{DS_ON_LS}} = 31 \text{ m}\Omega$ (typical)
- External Bias Input to Improve Efficiency
- Pin-Selectable Auto Mode or Forced PWM Operation
- Adjustable Frequency Range: 350 kHz to 2.2 MHz
- Synchronizable to External Clock
- Internal Compensation
- Power-Good Flag
- Precision Enable to Program System UVLO
- Flexible Soft-Start Features:
 - Start-up into Pre-Biased Load
 - Fixed or Adjustable Soft-Start Time
 - Output Voltage Tracking
- Cycle-by-Cycle Current Limiting
- Short-Circuit Protection With Hiccup Mode
- Thermal Shutdown Protection
- Create a Custom Design With the WEBENCH[®] Power Designer using [LM73605](#) or [LM73606](#)

2 Applications

- Industrial Distributed Power Applications
- Telecommunications Systems
- General-Purpose Wide V_{IN} Regulation

3 Description

The LM73605/LM73606 family of devices are easy-to-use synchronous step-down DC-DC converters capable of driving up to 5 A (LM73605) or 6 A (LM73606) of load current from a supply voltage ranging from 3.5 V to 36 V. The LM73605/LM73606 provide exceptional efficiency and output accuracy in a very small solution size. Peak current-mode control is employed. Additional features such as adjustable switching frequency, synchronization to an external clock, FPWM option, power-good flag, precision enable, adjustable soft start, and tracking provide both flexible and easy-to-use solutions for a wide range of applications. Automatic frequency foldback at light load and optional external bias improve efficiency over the entire load range. The family requires few external components and has a pinout designed for simple PCB layout with optimal EMI and thermal performance. Protection features include thermal shutdown, input undervoltage lockout, cycle-by-cycle current limiting, and hiccup short-circuit protection. The LM73605 and LM73606 devices are pin-to-pin compatible for easy current scaling.

Device Information⁽¹⁾

PART NUMBER	PACKAGE	BODY SIZE (NOM)
LM73605	WQFN (30)	6.00 mm x 4.00 mm
LM73606	Wettable Flanks	

(1) For all available packages, see the orderable addendum at the end of the data sheet.

Simplified Schematic

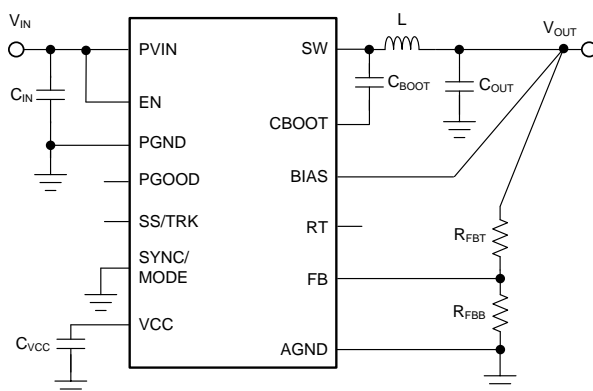

Copyright © 2017, Texas Instruments Incorporated

Efficiency vs Load Current $V_{\text{OUT}} = 5 \text{ V}$, $f_{\text{sw}} = 500 \text{ kHz}$, Auto Mode

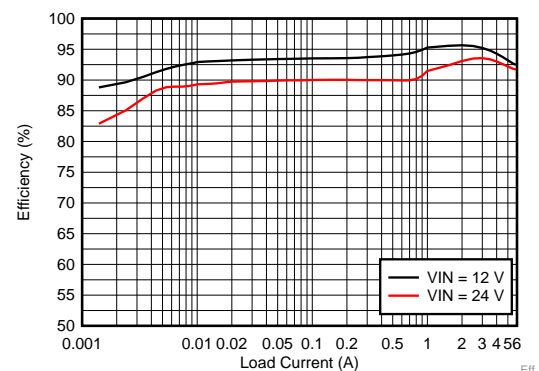

Table of Contents

1 Features	1	7.4 Device Functional Modes.....	23
2 Applications	1	8 Application and Implementation	25
3 Description	1	8.1 Application Information.....	25
4 Revision History	2	8.2 Typical Application	25
5 Pin Configuration and Functions	3	9 Power Supply Recommendations	39
6 Specifications	5	10 Layout	39
6.1 Absolute Maximum Ratings	5	10.1 Layout Guidelines	39
6.2 ESD Ratings.....	5	10.2 Layout Example	42
6.3 Recommended Operating Conditions.....	5	11 Device and Documentation Support	43
6.4 Thermal Information	6	11.1 Device Support.....	43
6.5 Electrical Characteristics.....	6	11.2 Related Documentation	43
6.6 Timing Characteristics.....	7	11.3 Related Links	43
6.7 Switching Characteristics	8	11.4 Receiving Notification of Documentation Updates	43
6.8 System Characteristics	8	11.5 Community Resources.....	44
6.9 Typical Characteristics	9	11.6 Trademarks	44
7 Detailed Description	11	11.7 Electrostatic Discharge Caution.....	44
7.1 Overview	11	11.8 Glossary	44
7.2 Functional Block Diagram	11	12 Mechanical, Packaging, and Orderable	
7.3 Feature Description	12	Information	45

4 Revision History

DATE	REVISION	NOTES
September 2017	*	Initial release

5 Pin Configuration and Functions

RNP Package
30-Pin Wettable Flanks QFN (WQFN) 6 mm × 4 mm × 0.8 mm
Top View

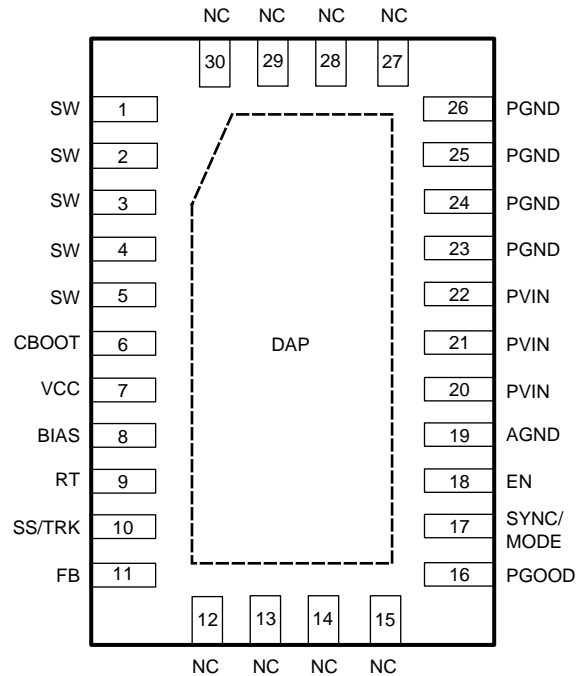

Pin Functions

PIN		I/O ⁽¹⁾	DESCRIPTION
NO.	NAME		
1, 2, 3, 4, 5	SW	P	Switching output of the regulator. Internally connected to source of the HS FET and drain of the LS FET. Connect to power inductor and boot-strap capacitor.
6	CBOOT	P	Boot-strap capacitor connection for HS FET driver. Connect a high-quality 470-nF capacitor from this pin to the SW pin.
7	VCC	P	Output of internal bias supply. Used as supply to internal control circuits and drivers. Connect a high-quality 2.2- μ F capacitor from this pin to GND. TI does not recommend loading this pin by external circuitry.
8	BIAS	P	Optional BIAS LDO supply input. TI recommends tying to V_{OUT} when $3.3\text{ V} \leq V_{OUT} \leq 18\text{ V}$, or tie to an external 3.3-V or 5-V rail if available, to improve efficiency. BIAS pin voltage must not be greater than V_{IN} . Tie to ground when not in use.
9	RT	A	Switching frequency setting pin. Place a resistor from this pin to ground to set the switching frequency. If floating, the default switching frequency will be 500 kHz. Do not short to ground.
10	SS/TRK	A	Soft-start control pin. Leave this pin floating for a 5-ms internal soft-start ramp. An external capacitor can be connected from this pin to ground to extend the soft start time. A 2- μ A current sourced from this pin charges the capacitor to provide the ramp. Connect to external ramp for tracking. Do not short to ground.
11	FB	I	Feedback input for output voltage regulation. Connect a resistor divider to set the output voltage. Never short this pin to ground during operation.
12–15, 27–30	NC	—	No internal connection. Connect to ground net and copper to improve heat sinking and board-level reliability.
16	PGOOD	O	Open drain power-good flag output. Connect to suitable voltage supply through a current limiting resistor. High = V_{OUT} regulation OK, Low = V_{OUT} regulation fault. PGOOD = LOW when EN = low and $V_{IN} > 2\text{ V}$.

(1) A = Analog, O = Output, I = Input, G = Ground, P = Power

Pin Functions (continued)

PIN		I/O ⁽¹⁾	DESCRIPTION
NO.	NAME		
17	SYNC/MODE	I	Synchronization input and mode setting pin. Do not float. Tie to ground if not used. Tie to ground: auto mode, higher efficiency at light loads; Tie to logic high: forced PWM, constant switching frequency over load; Tie to external clock source: forced PWM, synchronize to the rising edge of the external clock.
18	EN	I	Enable input to regulator. Do not float. High = ON, Low = OFF. Can be tied to PVIN. Precision enable input allows adjustable input voltage UVLO using external resistor divider.
19	AGND	G	Analog ground. Ground reference for internal circuitry. All electrical parameters are measured with respect to this pin. Connect to system ground on PCB.
20–22	PVIN	P	Supply input to internal bias LDO and HS FET. Connect to input supply and input bypass capacitors C _{IN} . C _{IN} must be placed right next to this pin and PGND pins on PCB, and connected with short and wide traces.
23–26	PGND	G	Power ground, connected to the source of LS FET internally. Connect to system ground, DAP/EP, AGND, ground side of C _{IN} and C _{OUT} on PCB. Path to C _{IN} must be as short as possible
EP	DAP	G	Low impedance connection to AGND. Connect to system ground on PCB. Major heat dissipation path for the device. Must be used for heat sinking by soldering to ground copper on PCB. Thermal vias are preferred to improve heat dissipation to other layers.

6 Specifications

6.1 Absolute Maximum Ratings

Over operating free-air temperature range of -40°C to $+125^{\circ}\text{C}$ (unless otherwise noted)⁽¹⁾

	PARAMETER	MIN	MAX	UNIT
Input voltages	PVIN to PGND	-0.3	42	V
	EN to AGND	-0.3	$V_{\text{IN}} + 0.3$	
	FB, RT, SS/TRK to AGND	-0.3	5	
	PGOOD to AGND	-0.1	20	
	SYNC to AGND	-0.3	5.5	
	BIAS to AGND	-0.3	Lower of $(V_{\text{IN}} + 0.3)$ or 20	
	AGND to PGND	-0.3	0.3	
Output voltages	SW to PGND	-0.3	$V_{\text{IN}} + 0.3$	V
	SW to PGND less than 10-ns transients	-3.5	42	
	CBOOT to SW	-0.3	5	
	VCC to AGND	-0.3	5	
Operating junction temperature, T_{J}		-40	150	$^{\circ}\text{C}$
Storage temperature, T_{stg}		-65	150	$^{\circ}\text{C}$

- (1) Stresses beyond those listed under *Absolute Maximum Ratings* may cause permanent damage to the device. These are stress ratings only, which do not imply functional operation of the device at these or any other conditions beyond those indicated under *Recommended Operating Conditions*. Exposure to absolute-maximum-rated conditions for extended periods may affect device reliability.

6.2 ESD Ratings

		VALUE	UNIT
$V_{\text{(ESD)}}$ Electrostatic discharge	Human-body model (HBM), per ANSI/ESDA/JEDEC JS-001 ⁽¹⁾	± 2000	V
	Charged-device model (CDM), per JEDEC specification JESD22-C101 ⁽²⁾	± 750	

- (1) JEDEC document JEP155 states that 500-V HBM allows safe manufacturing with a standard ESD control process.
 (2) JEDEC document JEP157 states that 250-V CDM allows safe manufacturing with a standard ESD control process.

6.3 Recommended Operating Conditions

Over operating free-air temperature range of -40°C to $+125^{\circ}\text{C}$ (unless otherwise noted)⁽¹⁾

		MIN	MAX	UNIT
Input voltages	PVIN to PGND	3.5	36	V
	EN	0	V_{IN}	
	FB	0	4.5	
	PGOOD	0	18	
	BIAS input not used	0	0.3	
	BIAS input used	0	Lower of $(V_{\text{IN}} + 0.3)$ or 18	
	AGND to PGND	-0.1	0.1	
Output voltage	V_{OUT}	1	95% of V_{IN}	V
Output current	I_{OUT} , LM73605	0	5	A
	I_{OUT} , LM73606	0	6	A
Temperature	Operating junction temperature, T_{J}	-40	125	$^{\circ}\text{C}$

- (1) Recommended operating rating indicate conditions for which the device is intended to be functional, but do not ensure specific performance limits. For ensured specifications, see [Electrical Characteristics](#)

6.4 Thermal Information

THERMAL METRIC ⁽¹⁾		LM73605/LM73606	
		RNP (WQFN)	
		30 PINS	
Symbol	Description	Value	Unit
$R_{\theta JA}$	Junction-to-ambient thermal resistance	34.3	°C/W
$R_{\theta JC(top)}$	Junction-to-case (top) thermal resistance	14.6	°C/W
$R_{\theta JB}$	Junction-to-board thermal resistance	7.3	°C/W
ψ_{JT}	Junction-to-top characterization parameter	0.1	°C/W
ψ_{JB}	Junction-to-board characterization parameter	7.1	°C/W
$R_{\theta JC(bot)}$	Junction-to-case (bottom) thermal resistance	1	°C/W

(1) For more information about traditional and new thermal metrics, see the [Semiconductor and IC Package Thermal Metrics](#) application report.

6.5 Electrical Characteristics

Limits apply over the recommended operating junction temperature (T_J) range of -40°C to $+125^{\circ}\text{C}$, unless otherwise stated. Minimum and maximum limits are specified through test, design or statistical correlation. Typical values represent the most likely parametric norm at $T_J = 25^{\circ}\text{C}$, and are provided for reference purposes only. Unless otherwise stated, the following conditions apply: $V_{IN} = 12\text{ V}$, $V_{OUT} = 3.3\text{ V}$, $f_{SW} = 500\text{ kHz}$.

PARAMETER		TEST CONDITIONS	MIN	TYP	MAX	UNIT
SUPPLY VOLTAGE (PVIN PINS)						
V_{IN}	Operating input voltage range		3.5		36	V
I_{SD}	Shutdown quiescent current; measured at V_{IN} pin ⁽¹⁾	$V_{EN} = 0\text{ V}$ $T_J = 25^{\circ}\text{C}$		0.8	10	μA
I_{Q_NONSW}	Operating quiescent current from V_{IN} (non-switching)	$V_{EN} = 2\text{ V}$, $V_{FB} = 1.5\text{ V}$, $V_{BIAS} = 3.3\text{ V}$ external		0.6	12	μA
ENABLE (EN PIN)						
$V_{EN_VCC_H}$	Enable input high level for V_{CC} output	V_{EN} rising			1.15	V
$V_{EN_VCC_L}$	Enable input low level for V_{CC} output	V_{EN} falling	0.3			V
$V_{EN_VOUT_H}$	Enable input high level for V_{OUT}	V_{EN} rising	1.14	1.196	1.25	V
$V_{EN_VOUT_HYS}$	Enable input hysteresis for V_{OUT}	V_{EN} falling hysteresis		-100		mV
I_{LKG_EN}	Enable input leakage current	$V_{EN} = 2\text{ V}$		1.4	200	nA
INTERNAL LDO (VCC PIN, BIAS PIN)						
V_{CC}	Internal V_{CC} voltage	PWM operation		3.27		V
		PFM operation		3.1		V
V_{CC_UVLO}	Internal V_{CC} undervoltage lockout	V_{CC} rising	2.96	3.14	3.27	V
		V_{CC} falling hysteresis		-605		mV
V_{BIAS_ON}	Input changeover	V_{BIAS} rising		3.09	3.25	V
		V_{BIAS} falling hysteresis		-63		mV
I_{BIAS_NONSW}	Operating quiescent current from external V_{BIAS} (non-switching)	$V_{EN} = 2\text{ V}$, $V_{FB} = 1.5\text{ V}$, $V_{BIAS} = 3.3\text{ V}$ external		21	50	μA
VOLTAGE REFERENCE (FB PIN)						
V_{FB}	Feedback voltage	PWM mode	0.987	1.006	1.017	V
I_{LKG_FB}	Input leakage current at FB pin	$V_{FB} = 1\text{ V}$		0.2	60	nA

(1) Shutdown current includes leakage current of the switching transistors.

Electrical Characteristics (continued)

Limits apply over the recommended operating junction temperature (T_J) range of -40°C to $+125^{\circ}\text{C}$, unless otherwise stated. Minimum and maximum limits are specified through test, design or statistical correlation. Typical values represent the most likely parametric norm at $T_J = 25^{\circ}\text{C}$, and are provided for reference purposes only. Unless otherwise stated, the following conditions apply: $V_{IN} = 12\text{ V}$, $V_{OUT} = 3.3\text{ V}$, $f_{SW} = 500\text{ kHz}$.

PARAMETER		TEST CONDITIONS	MIN	TYP	MAX	UNIT
HIGH SIDE DRIVER (CBOOT PIN)						
V_{CBOOT_UVLO}	CBOOT - SW undervoltage lockout		1.6	2.2	2.7	V
CURRENT LIMITS AND HICCUP						
I_{HS_LIMIT}	Short-circuit, high-side current limit ⁽²⁾	LM73605	6	7.3	8.35	A
		LM73606	7.4	8.7	9.85	
I_{LS_LIMIT}	Low-side current limit ⁽²⁾	LM73605	4.79	5.5	6.1	A
		LM73606	5.8	6.6	7.25	
I_{NEG_LIMIT}	Negative current limit	LM73605		-5		A
		LM73606		-6		
V_{HICCUP}	Hiccup threshold on FB pin		0.36	0.4	0.44	V
I_{L_ZC}	Zero cross-current limit			0.06		A
SOFT START (SS/TRK PIN)						
I_{SSC}	Soft-start charge current		1.8	2	2.2	μA
R_{SSD}	Soft-start discharge resistance	UVLO, TSD, OCP, or EN = 0		1		$\text{k}\Omega$
POWER GOOD (PGOOD PIN) and OVERVOLTAGE PROTECTION						
V_{PGOOD_OV}	Power-good overvoltage threshold	% of FB voltage	106%	110%	113%	
V_{PGOOD_UV}	Power-good undervoltage threshold	% of FB voltage	86%	90%	93%	
V_{PGOOD_HYS}	Power-good hysteresis	% of FB voltage		1.2%		
V_{PGOOD_VALID}	Minimum input voltage for proper PGOOD function	50- μA pullup to PGOOD pin, $V_{EN} = 0\text{ V}$, $T_J = 25^{\circ}\text{C}$		1.3	2	V
R_{PGOOD}	Power-good ON-resistance	$V_{EN} = 2.5\text{ V}$		40	100	Ω
		$V_{EN} = 0\text{ V}$		30	90	
MOSFETS						
$R_{DS_ON_HS}$ ⁽³⁾	High-side MOSFET ON-resistance	$I_{OUT} = 1\text{ A}$, $V_{BIAS} = V_{OUT} = 3.3\text{ V}$		53	90	$\text{m}\Omega$
$R_{DS_ON_LS}$ ⁽³⁾	Low-side MOSFET ON-resistance	$I_{OUT} = 1\text{ A}$, $V_{BIAS} = V_{OUT} = 3.3\text{ V}$		31	55	$\text{m}\Omega$
THERMAL SHUTDOWN						
T_{SD} ⁽⁴⁾	Thermal shutdown threshold	Shutdown threshold		160		$^{\circ}\text{C}$
	Recovery threshold			135		$^{\circ}\text{C}$

(2) This current limit was measured as the internal comparator trip point. Due to inherent delays in the current limit comparator and drivers, the peak current limit measured in closed loop with faster slew rate will be larger, and valley current limit will be lower.

(3) Measured at pins

(4) Ensured by design

6.6 Timing Characteristics

		MIN	NOM	MAX	UNIT
CURRENT LIMITS AND HICCUP					
N_{OC} ⁽¹⁾	Number of switching cycles before hiccup is tripped		128		Cycles
t_{OC}	Overcurrent hiccup retry delay time		46		ms

(1) Ensured by design

Timing Characteristics (continued)

			MIN	NOM	MAX	UNIT
SOFT START (SS/TRK PIN)						
t_{SS}	Internal soft-start time	$C_{SS} = \text{OPEN}$, from EN rising edge to PGOOD rising edge	3.5	6.3		ms
POWER GOOD (PGOOD PIN) and OVERVOLTAGE PROTECTION						
t_{PGOOD_RISE}	PGOOD rising edge deglitch delay		80	140	200	μs
t_{PGOOD_FALL}	PGOOD falling edge deglitch delay		80	140	200	μs

6.7 Switching Characteristics

PARAMETER	TEST CONDITIONS		MIN	TYP	MAX	UNIT
PWM LIMITS (SW PINS)						
t_{ON-MIN}	Minimum switch on-time			60	82	ns
$t_{OFF-MIN}$	Minimum switch off-time			70	120	ns
t_{ON-MAX}	Maximum switch on-time	HS timeout in dropout	3	6	9	μs
OSCILLATOR (RT and SYNC PINS)						
f_{OSC}	Internal oscillator frequency	$R_T = \text{Open}$	440	500	560	kHz
f_{ADJ}	Minimum adjustable frequency by R_T or SYNC	$R_T = 115 \text{ k}\Omega$, 0.1%	315	350	385	kHz
	Maximum adjustable frequency by R_T or SYNC	$R_T = 17.4 \text{ k}\Omega$, 0.1%	1980	2200	2420	kHz
V_{SYNC_HIGH}	Sync input high level threshold				2	V
V_{SYNC_LOW}	Sync input low level threshold		0.4			V
V_{MODE_HIGH}	Mode input high level threshold for FPWM			0.42		V
V_{MODE_LOW}	Mode input low level threshold for AUTO mode			0.4		V
t_{SYNC_MIN}	Sync input minimum ON and OFF-time			80		ns

6.8 System Characteristics

The following specifications apply to the circuit found in typical [schematic](#) with appropriate modifications from typical [bill of materials](#). These parameters are not tested in production and represent typical performance only. Unless otherwise stated the following conditions apply: $T_A = 25^\circ\text{C}$, $V_{IN} = 12 \text{ V}$, $V_{OUT} = 3.3 \text{ V}$, $f_{SW} = 500 \text{ kHz}$.

PARAMETER	TEST CONDITIONS		MIN	TYP	MAX	UNIT
V_{FB_PFM}	Output voltage offset at no load in auto mode	$V_{IN} = 3.8 \text{ V}$ to 36 V , $V_{SYNC} = 0 \text{ V}$, auto mode $I_{OUT} = 0 \text{ A}$		2%		
V_{DROP}	Minimum input to output voltage differential to maintain specified accuracy	$V_{OUT} = 5 \text{ V}$, $I_{OUT} = 3 \text{ A}$, $f_{SW} = 2.2 \text{ MHz}$		0.4		V
I_{Q_SW}	Operating quiescent current (switching)	$V_{EN} = 3.3 \text{ V}$, $I_{OUT} = 0 \text{ A}$, $R_T = \text{open}$, $V_{BIAS} = V_{OUT} = 3.3 \text{ V}$, $R_{FBT} = 1 \text{ Meg}$		15		μA
I_{PEAK_MIN}	Minimum inductor peak current	LM73605: $V_{SYNC} = 0$, $I_{OUT} = 10 \text{ mA}$		1		A
		LM73606: $V_{SYNC} = 0 \text{ V}$, $I_{OUT} = 10 \text{ mA}$		1.3		
I_{BIAS_SW}	Operating quiescent current from external V_{BIAS} (switching)	$f_{SW} = 500 \text{ kHz}$, $I_{OUT} = 1 \text{ A}$		7		mA
		$f_{SW} = 2.2 \text{ MHz}$, $I_{OUT} = 1 \text{ A}$		25		
D_{MAX}	Maximum switch duty cycle	While in frequency foldback	97.5%			
t_{DEAD}	Dead time between high-side and low-side MOSFETs			4		ns

6.9 Typical Characteristics

Unless otherwise specified, $V_{IN} = 12\text{ V}$, $V_{OUT} = 3.3\text{ V}$ and $f_{SW} = 500\text{ kHz}$. Curves represent most likely parametric norm at specified condition.

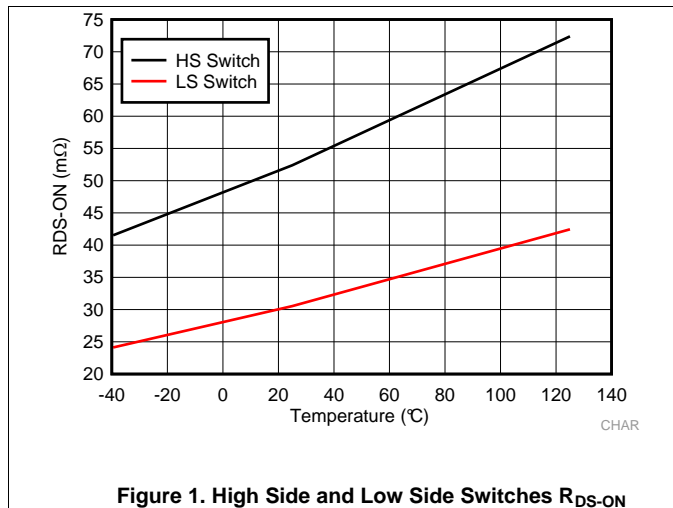

Figure 1. High Side and Low Side Switches R_{DS-ON}

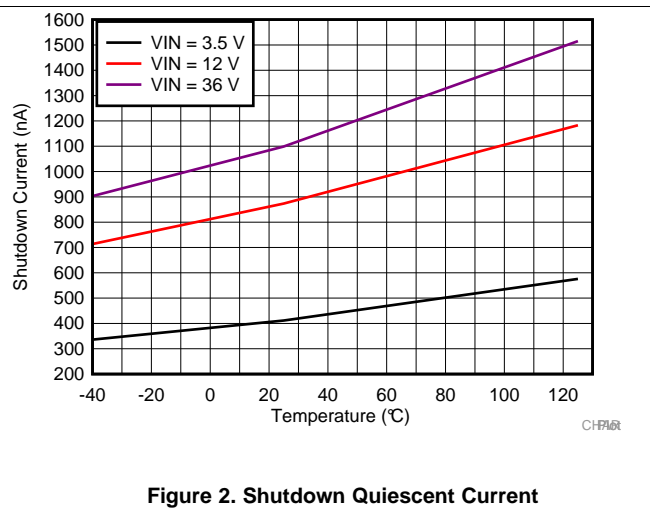

Figure 2. Shutdown Quiescent Current

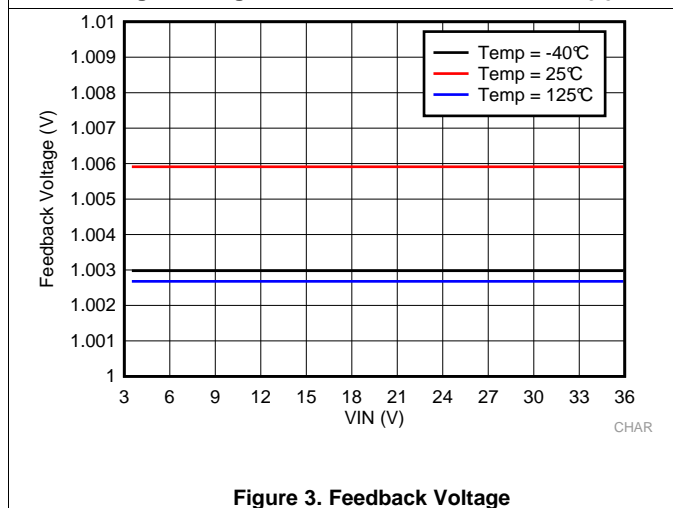

Figure 3. Feedback Voltage

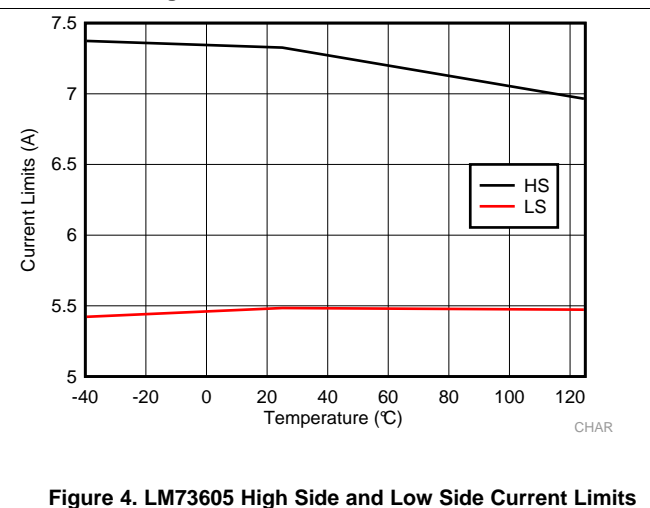

Figure 4. LM73605 High Side and Low Side Current Limits

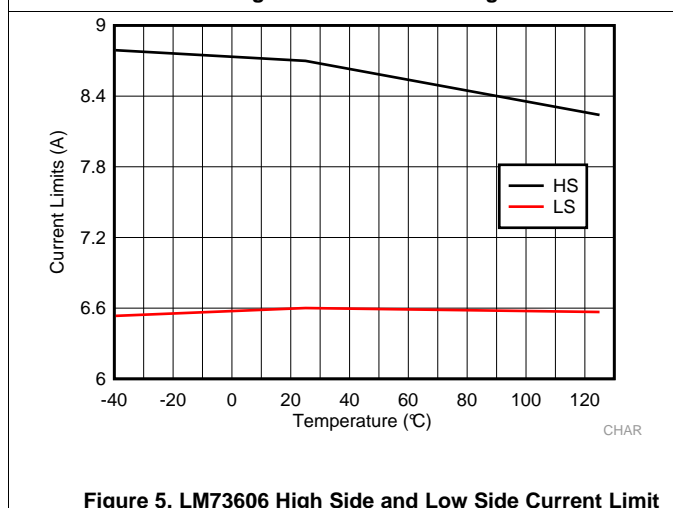

Figure 5. LM73606 High Side and Low Side Current Limit

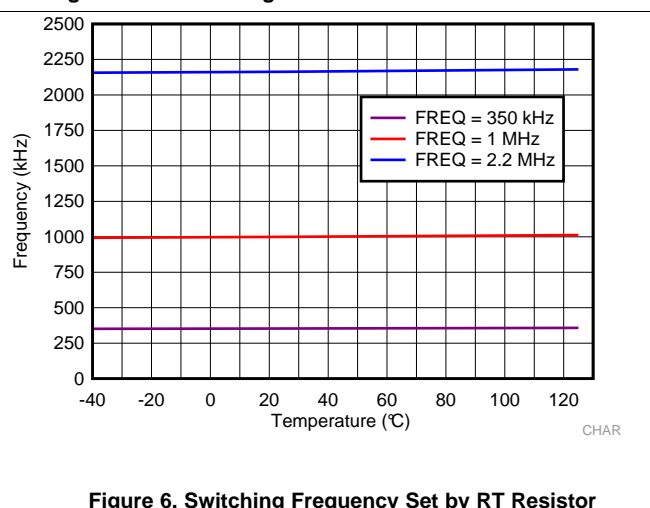

Figure 6. Switching Frequency Set by RT Resistor

Typical Characteristics (continued)

Unless otherwise specified, $V_{IN} = 12\text{ V}$, $V_{OUT} = 3.3\text{ V}$ and $f_{SW} = 500\text{ kHz}$. Curves represent most likely parametric norm at specified condition.

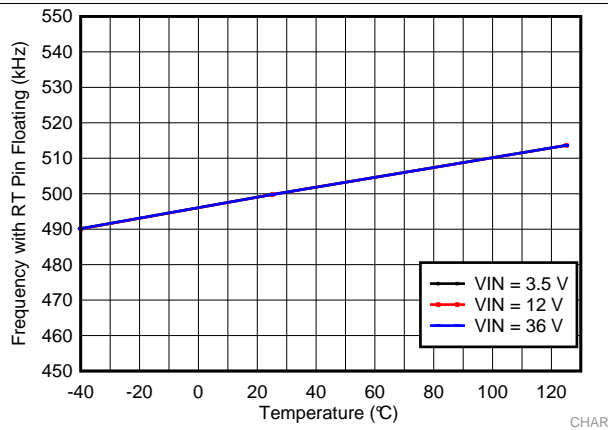

Figure 7. Switching Frequency with RT Pin Open Circuit

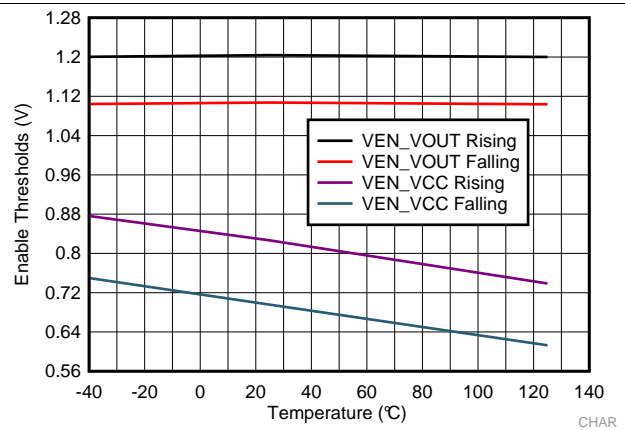

Figure 8. Enable Thresholds

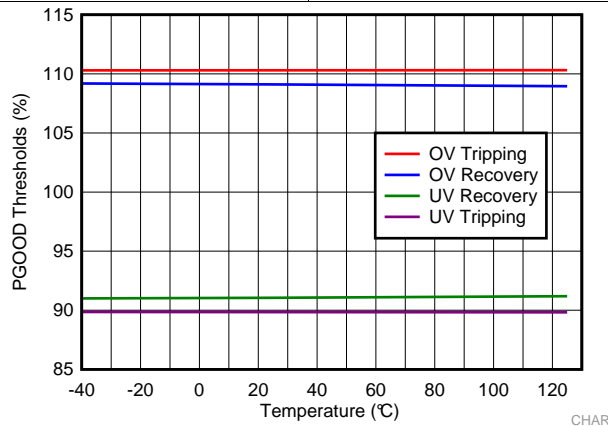

Figure 9. PGOOD Thresholds

7 Detailed Description

7.1 Overview

The LM73605/6 is an easy-to-use synchronous step-down DC-DC converter that operates from a 3.5-V to 36-V supply voltage. It is capable of delivering up to 5-A (LM73605) or 6-A (LM73606) DC load current with exceptional efficiency and thermal performance in a very small solution size.

The LM73605/6 employs fixed-frequency peak current-mode control with configurable auto or FPWM operation mode. Auto mode provides very high efficiency at light loads, and FPWM mode maintains constant switching frequency over entire load range.

The device is internally compensated, which reduces design time and the number of external components. The switching frequency is programmable from 350 kHz to 2.2 MHz by an external resistor. The LM73605/6 can also synchronize to an external clock within the same frequency range. The wide switching frequency range allows the device to be optimized for a wide range of system requirements. It can be optimized for small solution size with higher frequency; or for high efficiency with lower switching frequency. The LM73605/6 has very low quiescent current, which is critical for battery operated systems. It allows for a wide range of voltage conversion ratios due to very small minimum ON-time (t_{ON_MIN}) and minimum OFF-time (t_{OFF_MIN}). Automated frequency foldback is employed at very high or low duty cycles to further extend the operating range.

The LM73605/6 also features a power-good (PGOOD) flag, precision enable, internal or adjustable soft start, pre-biased start-up, and output voltage tracking. Protection features include thermal shutdown, undervoltage lockout (UVLO), cycle-by-cycle current limiting, and short-circuit hiccup protection. It provides flexible and easy-to-use solutions for a wide range of applications.

The family requires very few external components and has a pin out designed for simple, optimum PCB layout for enhanced EMI and thermal performance. The LM73605/6 device is available in a 30-pin WQFN leadless package.

7.2 Functional Block Diagram

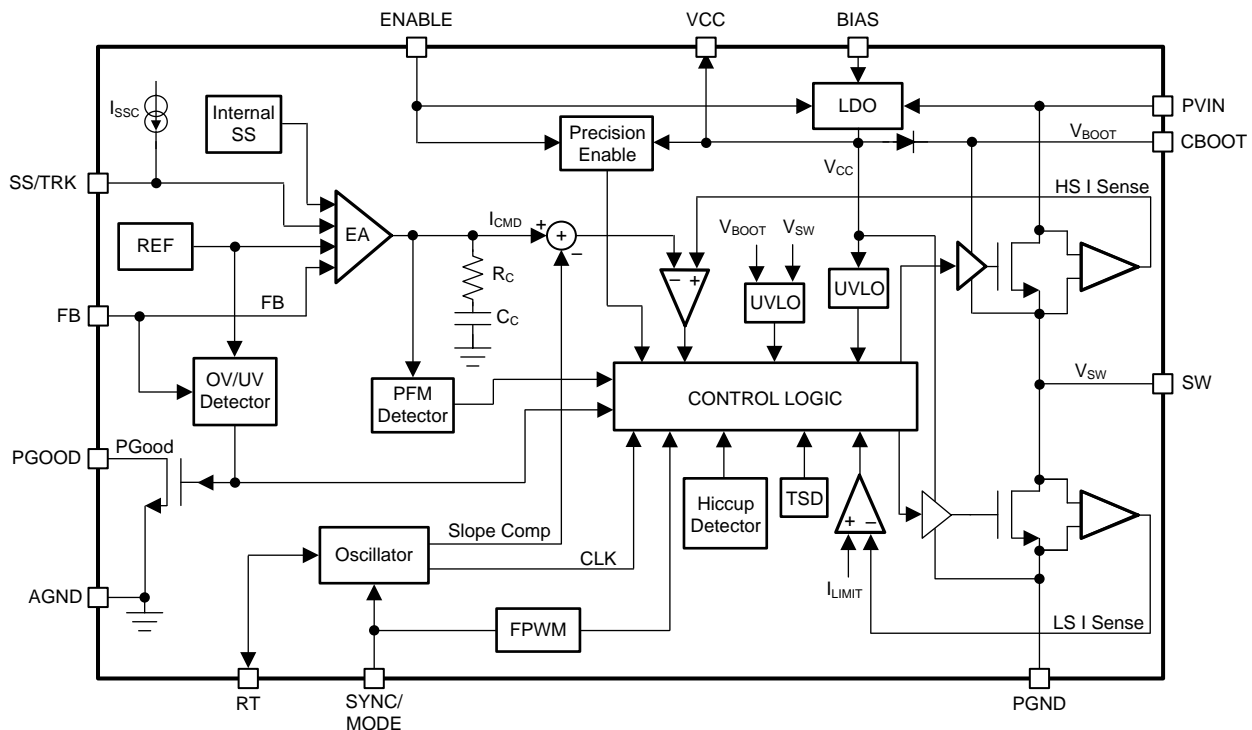

Copyright © 2017, Texas Instruments Incorporated

7.3 Feature Description

7.3.1 Synchronous Step-Down Regulator

The LM73605/6 is a synchronous buck converter with both power MOSFETs integrated in the device. [Figure 10](#) shows a simplified schematic for synchronous and non-synchronous buck converters. The synchronous buck integrates both high-side (HS) and low-side (LS) power MOSFETs. The non-synchronous buck integrates HS MOSFET and works with a discrete power diode as LS rectifier.

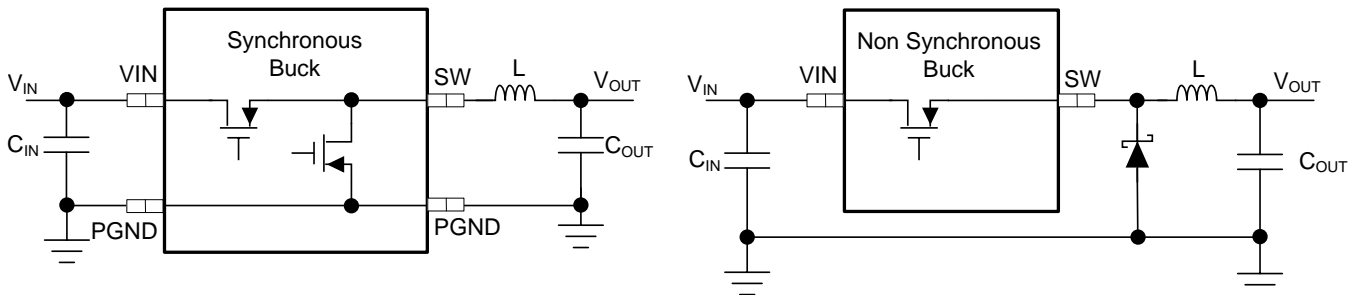

Copyright © 2017, Texas Instruments Incorporated

Figure 10. Simplified Synchronous vs Non-synchronous Buck Converters

A synchronous converter with integrated HS and LS MOSFETs offers benefits such as less design effort, lower external components count, reduced total solution size, higher efficiency at heavier load, easier PCB design, and more control flexibility.

The main advantage of a synchronous converter is that the voltage drop across the LS MOSFET is lower than the voltage drop across the power diode of a non-synchronous converter. Lower voltage drop translates into less power dissipation and higher efficiency. The LM73605/6 integrates HS and LS MOSFETs with very low on-time resistance to improve efficiency. It is especially beneficial when the output voltage is low. Because the LS MOSFET is integrated into the device, at light loads a synchronous converter has the flexibility to operate in either discontinuous or continuous conduction mode.

An integrated LS MOSFET also allows the controller to obtain inductor current information when the LS switch is on. It allows the control loop to make more complex decisions based on HS and LS currents. It allows the LM73605/6 to have peak and valley cycle-by-cycle current limiting for more robust protection.

7.3.2 Auto Mode and FPWM Mode

The LM73605/6 has configurable auto mode or FPWM options.

In auto mode, the device operates in diode emulation mode (DEM) at light loads. In DEM, inductor current stops flowing when it reaches 0 A. This is also referred to as discontinuous conduction mode (DCM). This is the same behavior as the non-synchronous regulator, with higher efficiency. At heavier load, when the inductor current valley is above 0 A, the device operates in continuous conduction mode (CCM), where the switching frequency is fixed and set by RT.

In auto mode, the peak inductor current has a minimum limit, I_{PEAK_MIN} , in the LM73605/6. When peak current reaches I_{PEAK_MIN} , the switching frequency reduces to regulate the required load current. Switching frequency lowers when load reduces. This is when the device operates in pulse frequency modulation (PFM). PFM further improves efficiency by reducing switching losses. Light load efficiency is especially important for battery operated systems.

In forced PWM (FPWM) mode, the device operates in CCM regardless of load with the frequency set by RT or synchronization input. Inductor current can go negative at light loads. At light loads, the efficiency is lower than auto mode, due to higher conduction losses and switching losses. In FPWM, the device has fixed switching frequency over the entire load range, which is beneficial to noise sensitive applications.

[Figure 11](#) shows the inductor current waveforms in each mode with heavy load, light load, and very light load. The difference between the two modes is at lighter loads where inductor current valley reaches zero.

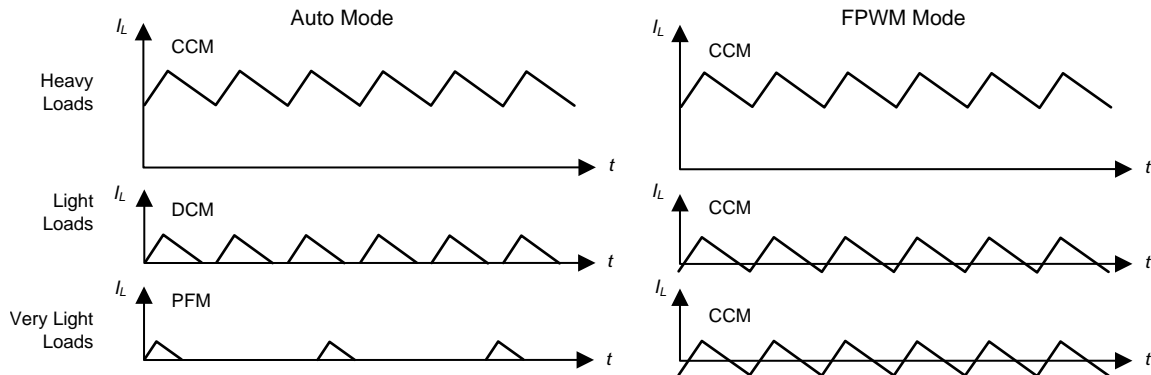
Feature Description (continued)

Figure 11. Inductor Current Waveforms at Auto Mode and FPWM Mode with Different Loads

In CCM, the inductor current peak-to-peak ripple can be estimated by [Equation 1](#):

$$I_{\text{ripple}} = \frac{(V_{\text{IN}} - V_{\text{OUT}})}{f_{\text{SW}} \times L} \times \frac{V_{\text{OUT}}}{V_{\text{IN}}} \quad (1)$$

The average or DC value of the inductor current equals the load current, or output current I_{OUT} , in steady state. Peak inductor current can be calculated by [Equation 2](#)

$$I_{\text{PEAK}} = I_{\text{OUT}} + I_{\text{Lripple}} / 2 \quad (2)$$

Valley inductor current can be calculated by [Equation 3](#)

$$I_{\text{VALLEY}} = I_{\text{OUT}} - I_{\text{Lripple}} / 2 \quad (3)$$

In auto mode, the CCM to DCM boundary condition is when $I_{\text{VALLEY}} = 0$ A. When $I_{\text{Lripple}} \geq I_{\text{PEAK-MIN}}$, the load current at the DCM boundary condition can be found by [Equation 4](#). When the peak-to-peak ripple current is smaller than $I_{\text{Lripple}} \geq I_{\text{PEAK-MIN}}$, the PFM boundary will be reached first.

$$I_{\text{OUT-DCM}} = I_{\text{Lripple}} / 2$$

when

- $I_{\text{Lripple}} \geq I_{\text{PEAK-MIN}}$ (4)

In auto mode, the PFM operation boundary condition is when $I_{\text{PEAK}} = I_{\text{PEAK-MIN}}$. Frequency foldback occurs when peak current drops to $I_{\text{PEAK-MIN}}$, no matter in CCM or DCM operation. When current ripple is small, $I_{\text{Lripple}} < I_{\text{PEAK-MIN}}$, the peak current will reach $I_{\text{PEAK-MIN}}$ when still in CCM. The output current at CCM PFM boundary can be found by [Equation 5](#)

$$I_{\text{OUT-CCM-PFM}} = I_{\text{PEAK-MIN}} - I_{\text{Lripple}} / 2$$

when

- $I_{\text{Lripple}} < I_{\text{PEAK-MIN}}$ (5)

The current ripple increases with reduced frequency if load reduces. When valley current reaches zero, the frequency continues to fold back with constant peak current and discontinuous current.

In FPWM mode, there is no $I_{\text{PEAK-MIN}}$ limit. The peak current is defined by [Equation 2](#) at light loads and heavy loads.

See [Frequency Synchronization and Mode Setting](#) for mode setting options in LM73605/6. Mode setting only affects operation at light loads. There is no difference if load current is above the DCM and PFM boundary conditions discussed above.

Feature Description (continued)

7.3.3 Fixed-Frequency Peak Current-Mode Control

The LM73605/6 synchronous switched mode voltage regulator employs fixed frequency peak current mode control with advanced features. The fixed switching frequency is controlled by an internal clock. To get accurate DC load regulation, a voltage feedback loop is implemented to generate peak current command. The HS switch is turned on at the rising edge of the clock. As shown in Figure 12, during the HS switch on-time t_{ON} , the SW pin voltage V_{SW} swings up to approximately V_{IN} , and the inductor current I_L increases with a linear slope. The HS switch is turned off when the inductor current reaches the peak current command. During the HS switch off-time t_{OFF} , the LS switch is turned on. Inductor current discharges through the LS switch, which forces the V_{SW} to swing below ground by the voltage drop across the LS switch. The LS switch is turned off at the next clock cycle, before the HS switch is turned on. The regulation loop adjusts the peak current command to maintain a constant output voltage.

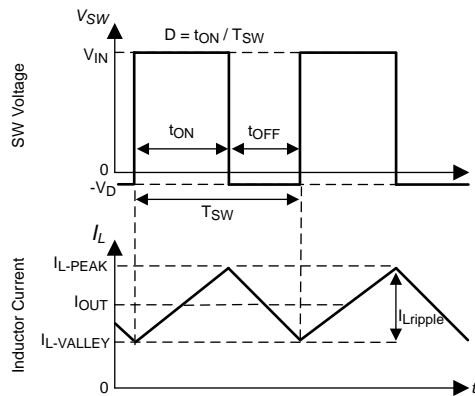

Figure 12. SW Voltage and Inductor Current Waveforms in CCM

Duty cycle D is defined by the on-time of the HS switch over the switching period:

$$D = t_{ON} / T_{SW}$$

where

- $T_{SW} = 1 / f_{SW}$ is the switching period (6)

In an ideal buck converter, where losses are ignored, D is proportional to the output voltage and inverse proportional to the input voltage: $D = V_{OUT} / V_{IN}$.

When the LM73605/6 is set to operate in auto mode, the LS switch is turned off when its current reaches zero ampere before the next clock cycle comes. Both HS switch and LS switch are off before the HS switch is turned on at the next clock cycle.

7.3.4 Adjustable Output Voltage

The voltage regulation loop in the LM73605/6 regulates the FB pin voltage to be the same as the internal reference voltage. The output voltage of the LM73605/6 is set by a resistor divider to program the ratio from V_{OUT} to V_{FB} . The resistor divider is connected from the output to ground with the mid-point connecting to the FB pin.

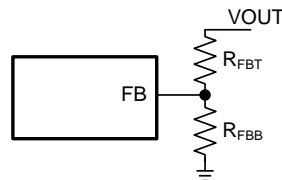

Figure 13. Output Voltage Setting by Resistor Divider

Feature Description (continued)

The internal voltage reference and feedback loop produce precise voltage regulation over temperature. TI recommends using divider resistors with 1% tolerance or better, and with temperature coefficient of 100 ppm or lower. Typically, $R_{FBT} = 10\text{ k}\Omega$ to $100\text{ k}\Omega$ is recommended. Larger R_{FBT} and R_{FBB} values reduce the quiescent current going through the divider, which help maintain high efficiency at very light load. But larger divider values also make the feedback path more susceptible to noise. If efficiency at very light load is critical in a certain application, R_{FBT} up to $1\text{ M}\Omega$ can be used.

R_{FBB} can be calculated by [Equation 7](#):

$$R_{FBB} = \frac{V_{FB}}{V_{OUT} - V_{FB}} R_{FBT} \quad (7)$$

The minimum programmable V_{OUT} equals V_{FB} , with R_{FBB} open. The maximum V_{OUT} is limited by the maximum duty cycle at a given frequency:

$$D_{MAX} = 1 - (t_{OFF_MIN} / T_{SW})$$

where

- t_{OFF_MIN} is the minimum off time of the HS switch
 - $T_{SW} = 1 / f_{SW}$ is the switching period
- (8)

Ideally, without frequency foldback, $V_{OUT_MAX} = V_{IN_MIN} \times D_{MAX}$.

Power losses in the circuit reduces the maximum output voltage. The LM73605/6 folds back switching frequency under t_{OFF_MIN} condition to further extend V_{OUT_MAX} . The device maintains output regulation with lower input voltage. The minimum fold-back frequency is limited by the maximum HS on-time, t_{ON_MAX} . Maximum output voltage with frequency foldback can be estimated by:

$$V_{OUT_MAX} = V_{IN_MIN} \times \frac{t_{ON_MAX}}{t_{ON_MAX} + t_{OFF_MIN}} - I_{OUT} \times (R_{DS_ON_HS} + DCR) \quad (9)$$

The voltage drops on the HS MOSFET and inductor DCR have been taken into account in [Equation 9](#). The switching losses were not included.

If the resistor divider is not connected properly, the output voltage cannot be regulated because the feedback loop cannot obtain correct output voltage information. If the FB pin is shorted to ground or disconnected, the output voltage is driven close to V_{IN} . The load connected to the output could be damaged under this condition. Do not short FB to ground or leave it open circuit during operation.

The FB pin is a noise sensitive node. It is important to place the resistor divider as close as possible to the FB pin, and route the feedback node with a short and thin trace. The trace connecting V_{OUT} to R_{FBT} can be long, but it must be routed away from the noisy area of the PCB. For more layout recommendations, see [Layout](#).

7.3.5 Enable and UVLO

The LM73605/6 regulates output voltage when the VCC voltage is higher than the undervoltage lock out (UVLO) level, V_{CC_UVLO} , and the EN voltage is higher than $V_{EN_VOUT_H}$.

The internal LDO output voltage VCC is turned on when the EN voltage is higher than $V_{EN_VCC_H}$. The precision enable circuitry is also turned on when VCC is above UVLO. Normal operation of the LM73605/6 with regulated output voltage is enabled when the EN voltage is greater than $V_{EN_VOUT_H}$. When the EN voltage is less than $V_{EN_VCC_L}$, the device is in shutdown mode. The internal dividers make sure $V_{EN_VOUT_H}$ is always higher than $V_{EN_VCC_H}$.

The EN pin cannot be left floating. The simplest way to enable the operation of the LM73605/6 is to connect the EN pin to PVIN, which allows self-start-up of the LM73605/6 when V_{IN} rises. Use of a pullup resistor between PVIN and EN pins helps reduce noise coupling from PVIN pin to the EN pin.

Many applications benefit from employing an enable divider to establish a customized system UVLO. This can be used either for sequencing, system timing requirement, or to reduce the occurrence of deep discharge of a battery power source. [Figure 14](#) shows how to use a resistor divider to set a system UVLO level. An external logic output can also be used to drive the EN pin for system sequencing.

Feature Description (continued)

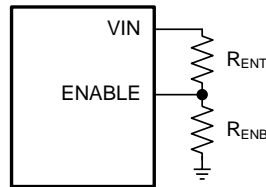

Figure 14. System UVLO

With a selected R_{ENT} , the R_{ENB} can be calculated by:

$$R_{ENB} = \frac{V_{EN_VOUT_H}}{V_{IN_ON_H} - V_{EN_VOUT_H}} R_{ENT}$$

where

- $V_{IN_ON_H}$ is the desired supply voltage threshold to turn on this device (10)

Note that the divider adds to supply quiescent current by $V_{IN} / (R_{ENT} + R_{ENB})$. Small R_{ENT} and R_{ENB} values add more quiescent current loss. However, large divider values make the node more sensitive to noise. R_{ENT} in the hundreds of $k\Omega$ range is a good starting point.

7.3.6 Internal LDO, V_{CC_UVLO} , and BIAS Input

The LM73605/6 integrates an internal LDO, generating VCC voltage for control circuitry and MOSFET drivers. The VCC pin must have a 1- μ F to 4.7- μ F bypass capacitor placed as close as possible to the pin and properly grounded. Do not load the VCC pin or short it to ground during operation. Shorting VCC pin to ground during operation may damage the device.

The UVLO on VCC voltage, V_{CC_UVLO} , turns off the regulation when VCC voltage is too low. It prevents the LM73605/6 from operating until the VCC voltage is enough for the internal circuitry. Hysteresis on V_{CC_UVLO} prevents the part from turning off during power up if V_{IN} droops due to input current demands. The LDO generates VCC voltage from one of the two inputs: the supply voltage V_{IN} , or the BIAS input. When BIAS is tied to ground, the LDO input is V_{IN} . When BIAS is tied to a voltage higher than 3.3 V, the LDO input is V_{BIAS} . BIAS voltage must be lower than both V_{IN} and 18 V.

The BIAS input is designed to reduce the LDO power loss. The LDO power loss is:

$$P_{LOSS_LDO} = I_{LDO} \times (V_{IN_LDO} - V_{OUT_LDO}) \quad (11)$$

The higher the difference between the input and output voltages of the LDO, the more loss occurs to supply the same LDO output current. The BIAS input provides an option to supply the LDO with a lower voltage than V_{IN} , to reduce the difference of the input and output voltages of the LDO and reduce power loss. For example, if the LDO current is 10 mA at a certain frequency with $V_{IN} = 24$ V and $V_{OUT} = 5$ V. The LDO loss with BIAS tied to ground is equal to $10 \text{ mA} \times (24 \text{ V} - 3.27 \text{ V}) = 207.3 \text{ mW}$, while the loss with BIAS tied to V_{OUT} is equal to $10 \text{ mA} \times (5 - 3.27) = 17.3 \text{ mW}$.

The efficiency improvement is more significant at light and mid loads because the LDO loss is a higher percentage in the total loss. The improvements is more significant with higher switching frequency because the LDO current is higher at higher switching frequency. The improvement is more significant when $V_{IN} \gg V_{OUT}$ because the voltage difference is higher.

[Figure 15](#) and [Figure 16](#) show efficiency improvement with bias tied to V_{OUT} in a $V_{OUT} = 5$ V and $f_{SW} = 2200$ kHz application, in auto mode and FPWM mode, respectively.

Feature Description (continued)

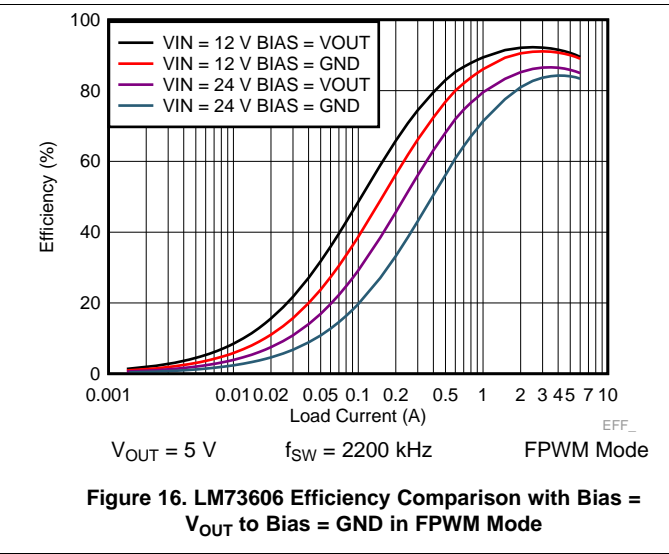
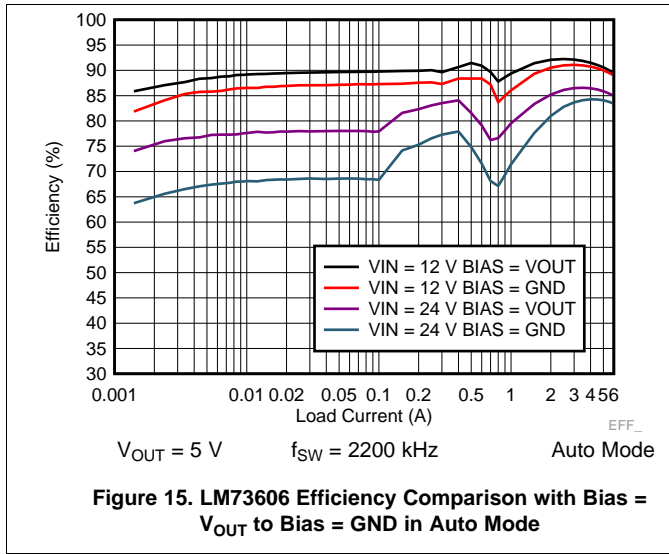

TI recommends tying the BIAS pin to V_{OUT} when V_{OUT} is equal to or greater than 3.3 V and no greater than 18 V. Tie the BIAS pin to ground when not in use. A ceramic capacitor, C_{BIAS} , can be used from the BIAS pin to ground for bypassing. If V_{OUT} has high frequency noise or spikes during transients or fault conditions, a resistor (1 to 10 Ω) connected between V_{OUT} to BIAS can be used together with C_{BIAS} for filtering.

The VCC voltage is typically 3.27 V. When the LM73605/6 is operating in PFM mode with frequency foldback, VCC voltage is reduced to 3.1 V (typical) to further decrease the quiescent current and improve efficiency at very light loads. Figure 17 shows an example of VCC voltage change with mode change.

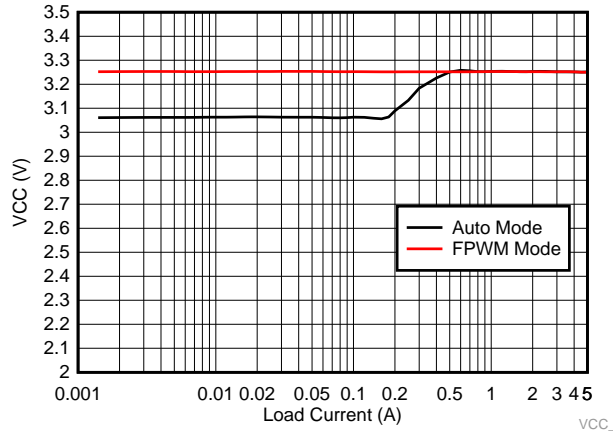

$V_{OUT} = 5\text{ V}$ $f_{SW} = 500\text{ kHz}$ $V_{IN} = 12\text{ V}$

Figure 17. VCC Voltage vs Load Current

VCC voltage has an internal undervoltage lockout threshold, V_{CC_UVLO} . When VCC voltage is higher than V_{CC_UVLO} rising threshold, the device is active and in normal operation if $V_{EN} > V_{EN_VOUT_H}$. If VCC voltage droops below V_{CC_UVLO} falling threshold, the V_{OUT} is shut down.

Feature Description (continued)

7.3.7 Soft Start and Voltage Tracking

The LM73605/6 features controlled output voltage ramp during start-up. The soft-start feature reduces inrush current during start-up and improves system performance and reliability.

If the SS/TRK pin is floating, the LM73605/6 starts up following the fixed internal soft-start ramp.

If longer soft-start time is desired, an external capacitor can be added from SS/TRK pin to ground. There is a 2- μ A (typical) internal current source, I_{SSC} , to charge the external capacitor. For a desired soft-start time t_{SS} , capacitance of C_{SS} can be found by [Equation 12](#).

$$C_{SS} = I_{SSC} \times t_{SS}$$

where

- C_{SS} = soft-start capacitor value (F)
 - I_{SSC} = soft-start charging current (A)
 - t_{SS} = desired soft-start time (s)
- (12)

The FB voltage always follows the lower potential of the internal voltage ramp or the voltage on the SS/TRK pin. Thus, the soft-start time can only be extended longer than the internal soft-start time by connecting C_{SS} . Use C_{SS} to extend soft-start time when there are a large amount of output capacitors, or the output voltage is high, or the output is heavily loaded during start-up.

LM73605/6 is operating in diode emulation mode during start-up regardless of mode setting. The device is capable of starting up into pre-biased output conditions. During start-up, the device sets the minimum inductor current to zero to avoid back charging the input capacitors.

LM73605/6 can track an external voltage ramp applied to the SS/TRK pin, if the ramp is slower than the internal soft-start ramp. The external ramp final voltage after start-up must be greater than 1.5 V to avoid noise interfering with the reference voltage. [Figure 18](#) shows how to use resistor divider to set V_{OUT} to follow an external ramp.

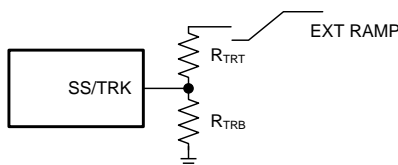

Figure 18. Soft Start Tracking External Ramp

V_{OUT} tracking also provides the option of ramping up faster than the internal start-up ramp. The FB voltage always follows the lower potential of the internal voltage ramp and the voltage on the SS/TRK pin. [Figure 19](#) shows the case when V_{OUT} ramps slower than the internal ramp, while [Figure 20](#) shows when V_{OUT} ramps faster than the internal ramp. If the tracking ramp is delayed after the internal ramp is completed, V_{FB} follows the tracking ramp even if it is faster than the internal ramp. Faster start-up time may result in large inductor current during start-up. Use with special care.

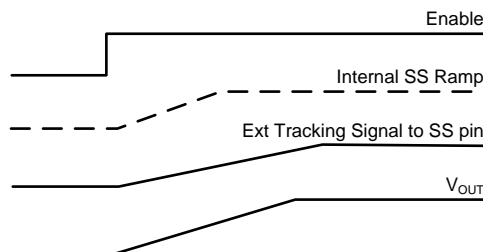

Figure 19. Tracking with Longer Start-up Time than the Internal Ramp

Feature Description (continued)

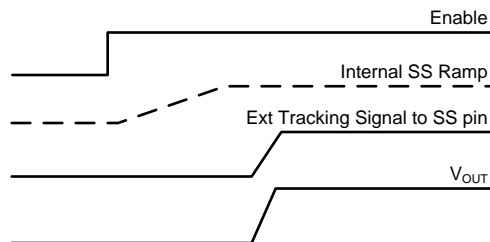

Figure 20. Tracking with Shorter Start-up Time than the Internal Ramp

The SS/TRK pin is discharged to ground by an internal pulldown resistor R_{SSD} when the output voltage is shutting down, such as in the event of UVLO, thermal shutdown, hiccup, or $V_{EN} = 0$. If a large C_{SS} is used, and the time when $V_{EN} = 0$ V is very short, the C_{SS} may not be fully discharged before the next soft start. Under this condition, the FB voltage follows the internal ramp slew rate until the voltage on C_{SS} is reached, then follow the slew rate defined by C_{SS} .

7.3.8 Adjustable Switching Frequency

The internal oscillator frequency is controlled by the impedance on the RT pin. If the RT pin is open circuit, the LM73605/6 operates at its default switching frequency, 500 kHz. The RT pin is not designed to be connected directly to ground. To program the switching frequency by RT resistor, Equation 13, or Figure 21, or Table 1 can be used to find the resistance value.

$$R_T(k\Omega) = \frac{1}{f_{SW}(kHz) \times 2.675 \times 10^{-5} - 0.0007} \quad (13)$$

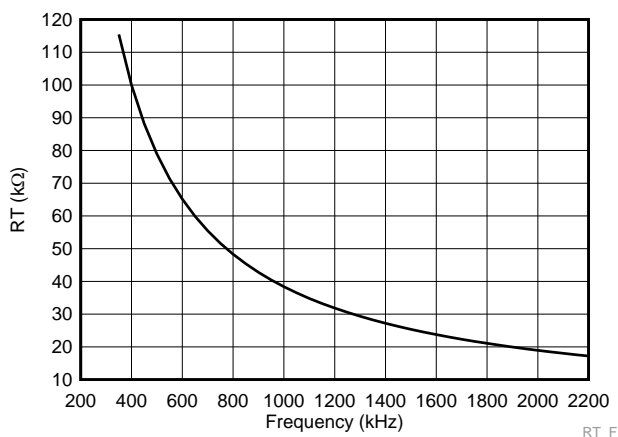

Figure 21. R_T Resistance vs Switching Frequency

Table 1. Typical Frequency Setting Resistance

SWITCHING FREQUENCY f_{SW} (kHz)	RT RESISTANCE (kΩ)
350	115
400	100
500	78.7 (or open)
750	52.3
1000	39.2
1500	26.1
2000	19.1
2200	17.4

The choice of switching frequency is usually a compromise between conversion efficiency and the size of the solution. Lower switching frequency has lower switching losses (including gate charge losses, switch transition losses, etc.). It usually results in higher overall efficiency. However, higher switching frequency allows the use of smaller power inductor and output capacitors, hence a more compact design. Lower inductance also helps transient response (higher large signal slew rate of inductor current), and has lower DCR. The optimal switching frequency is usually a trade-off in a given application and thus needs to be determined on a case-by-case basis. Factors that need to be taken into account include input voltage range, output voltage, most frequent load current level(s), external component choices, solution size/cost requirements, efficiency and thermal management requirements.

The choice of switching frequency may also be limited whether an operating condition triggers t_{ON_MIN} or t_{OFF_MIN} . Minimum on-time, t_{ON_MIN} , is the smallest time that the HS switch can be on. Minimum OFF-time, t_{OFF_MIN} , is the smallest duration that the HS switch can be off.

In CCM operation, t_{ON_MIN} and t_{OFF_MIN} limits the voltage conversion range given a selected switching frequency, f_{SW} . The minimum duty cycle allowed is:

$$D_{MIN} = t_{ON_MIN} \times f_{SW} \quad (14)$$

The maximum duty cycle allowed is:

$$D_{MAX} = 1 - t_{OFF_MIN} \times f_{SW} \quad (15)$$

Given an output voltage, the choice of the switching frequency affects the allowed input voltage range, solution size and efficiency. The maximum operational supply voltage can be found by:

$$V_{IN_MAX} = V_{OUT} / (f_{SW} \times t_{ON_MIN}) \quad (16)$$

At lower supply voltage, the switching frequency decreases once t_{OFF_MIN} is tripped. The minimum V_{IN} without frequency foldback can be approximated by:

$$V_{IN_MIN} = V_{OUT} / (1 - f_{SW} \times t_{OFF_MIN}) \quad (17)$$

With a desired V_{OUT} , the range of allowed V_{IN} is narrower with higher switching frequency.

LM73605/6 has an advanced frequency fold-back algorithm under both t_{ON_MIN} and t_{OFF_MIN} conditions. With frequency foldback, stable output voltage regulation is extended to wider range of supply voltages.

At very high V_{IN} conditions, where t_{ON_MIN} limitation is met, the switching frequency reduces to allow higher V_{IN} while maintaining V_{OUT} regulation. Note that the peak to peak inductor current ripple will increase with higher V_{IN} and lower frequency. TI does not recommend designing the circuit to operate with t_{ON_MIN} under typical conditions.

At very low V_{IN} conditions, where t_{OFF_MIN} limitation is met, the switching frequency decreases until t_{ON_MAX} condition is met. Such frequency fold-back mechanism allows the LM73605/6 to have very low dropout voltage regardless of frequency setting.

7.3.9 Frequency Synchronization and Mode Setting

The LM73605/6 switching action can synchronize to an external clock from 350 kHz to 2.2 MHz. TI recommends connecting the external clock to the SYNC/MODE pin with an appropriate termination resistor. Ground the SYNC/MODE pin if not used.

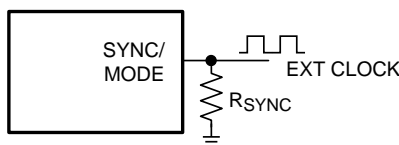

Figure 22. Frequency Synchronization

Recommendations for the external clock include a high level no lower than 2 V, low level no higher than 0.4 V, duty cycle between 10% and 90%, and both positive and negative pulse width no shorter than 80 ns. When the external clock fails at logic high or low, the LM73605/6 switches at the frequency programmed by the RT resistor after a time-out period. TI recommends connecting a resistor to the RT pin such that the internal oscillator frequency is the same as the external clock frequency. This allows the regulator to continue operating at approximately the same switching frequency if the external clock fails with the same control loop behavior.

The SYNC/MODE pin is also used as an operation mode control input.

- To set the operation in auto mode, connect SYNC/MODE pin to ground, or a logic signal lower than 0.3 V.
- To set the operation in FPWM mode, connect SYNC/MODE pin to a bias voltage or logic signal greater than 0.6 V.
- When the LM73605/6 is synchronized to an external clock, the operation mode is FPWM.

Table 2 summarizes the operation mode and features according to the SYNC/MODE input signal. For more details, see [Active Mode](#) and [Auto Mode and FPWM Mode](#).

Table 2. SYNC/MODE Pin Settings and Operation Modes

SYNC/MODE INPUT	SWITCHING FREQUENCY	OPERATING MODE	LIGHT LOAD BEHAVIOR
Logic low	Set by RT resistor	Auto mode	<ul style="list-style-type: none"> • No negative inductor current, device operates in discontinuous conduction mode (DCM) when current valley reaches 0 A. • Minimum peak inductor current is limited at $I_{PEAK-MIN}$; device operates in pulse frequency modulation (PFM) mode when peak current reaches $I_{PEAK-MIN}$. • Switching frequency reduces in PFM mode.
Logic high	Set by RT resistor	FPWM mode	<ul style="list-style-type: none"> • Fixed frequency continuous conduction mode (CCM) regardless of load • Inductor current have negative portion at light loads • No $I_{PEAK-MIN}$
External clock	Set by external clock		

7.3.10 Internal Compensation and C_{FF}

The LM73605/6 is internally compensated. The internal compensation is designed such that the loop response is stable over a wide operating frequency and output voltage range. The internal R-C values are 500 k Ω and 30 pF respectively.

When large resistance value (M Ω) is used for R_{FBT} , the pole formed by an internal parasitic capacitor and R_{FBT} can be low enough to reduce the phase margin. If only low ESR output capacitors (ceramic types) are used for C_{OUT} , the control loop could have low phase margin. To provide a phase boost an external feed-forward capacitor (C_{FF}) can be added in parallel with R_{FBT} . Choose the C_{FF} capacitor to provide most phase boost at the estimated crossover frequency f_x :

$$f_x = \frac{K}{V_{OUT} \times C_{OUT}}$$

where

- $K = 20.27$ with LM73605
- $K = 24.16$ with LM73606

Select C_{OUT} so that the f_x is no higher than 1/6 of the switching frequency. Typically, $f_x / f_{SW} = 1/10$ to 1/8 provides a good combination of stability and performance.

Place the external feed-forward capacitor in parallel with the top resistor divider R_{FBT} when additional phase boost is needed.

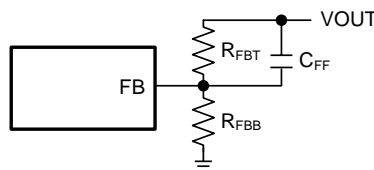

Figure 23. Feed-Forward Capacitor for Loop Compensation

The feed-forward capacitor C_{FF} in parallel with R_{FBT} places an additional zero before the crossover frequency of the control loop to boost phase margin. The zero frequency can be found by [Equation 19](#):

$$f_{Z-CFF} = 1 / (2\pi \times R_{FBT} \times C_{FF}) \tag{19}$$

An additional pole is also introduced with C_{FF} at the frequency of:

$$f_{P-CFF} = 1 / (2\pi \times C_{FF} \times (R_{FBT} // R_{FBB})) \tag{20}$$

Select the C_{FF} so that the bandwidth of the control loop without the C_{FF} is centered between f_{Z-CFF} and f_{P-CFF} . The zero at f_{Z-CFF} adds phase boost at the crossover frequency and improves transient response. The pole at f_{P-CFF} helps maintaining proper gain margin at frequency beyond the crossover.

The need of C_{FF} depends on R_{FBT} and C_{OUT} . Typically, choose $R_{FBT} \leq 100 \text{ k}\Omega$. C_{FF} may not be required, because the internal parasitic pole is at higher frequency. If C_{OUT} has larger ESR, and ESR zero $f_{Z-ESR} = 1 / (2\pi \times \text{ESR} \times C_{OUT})$ is low enough to provide phase boost around the crossover frequency, do not use C_{FF} . Equation 21 was tested for ceramic output capacitors:

$$C_{FF} = \frac{1}{2 \times \pi \times f_x} \times \frac{1}{\sqrt{R_{FBT} \times (R_{FBT} // R_{FBB})}} \quad (21)$$

The C_{FF} creates a time constant with R_{FBT} that couples in the attenuated output voltage ripple to the FB node. If the C_{FF} value is too large, it can couple too much ripple to the FB and affect V_{OUT} regulation. It could also couple too much transient voltage deviation and falsely trigger PGOOD flag.

7.3.11 Bootstrap Capacitor and $V_{BOOT-UVLO}$

The driver of the HS switch requires a bias voltage higher than the V_{IN} voltage. The capacitor, C_{BOOT} in [Simplified Schematic](#), connected between CBOOT and SW pins works as a charge pump to boost voltage on the CBOOT pin to $(V_{SW} + V_{CC})$. A boot diode is integrated on the die to minimize external component count. TI recommends a high-quality 0.47- μF , 6.3-V or higher voltage ceramic capacitor for C_{BOOT} . The $V_{BOOT-UVLO}$ threshold is designed to maintain proper HS switch operation. If the C_{BOOT} is not charged above this voltage with respect to SW, the device initiates a charging sequence using the LS switch before turning on the HS switch.

7.3.12 Power-Good and Overvoltage Protection

The LM73605/6 has a built-in power-good (PGOOD) flag to indicate whether the output voltage is at an appropriate level or not. The PGOOD flag can be used for start-up sequencing of multiple rails. The PGOOD pin is an open-drain output that requires a pullup resistor to an appropriate logic voltage (any voltage below 15 V). The pin can sink 5 mA of current and maintain its specified logic low level. A typical pullup resistor value is 10 k Ω to 100 k Ω . When the FB voltage is higher than $V_{PGOOD-OV}$ or lower than $V_{PGOOD-UV}$ threshold, the PGOOD internal switch is turned on, and the PGOOD pin voltage is pulled low. When the FB is within the range, the PGOOD switch is turned off, and the pin is pulled up to the voltage connected to the pullup resistor. The PGOOD function also have a deglitch timer for about 140 μs for each transition. If it is desired to pull up PGOOD pin to a voltage higher than 15 V, a resistor divider can be used to divide the voltage down.

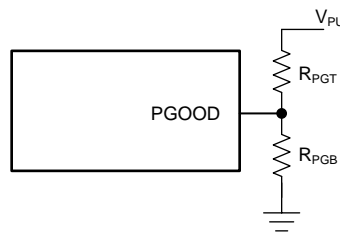

Figure 24. Divider for PGOOD Pullup Voltage

With a given pullup voltage V_{PU} , select a desired voltage on the PGOOD pin, V_{PG} . With a selected R_{PGT} , the R_{PGB} can be found by:

$$R_{PGB} = \frac{V_{PG}}{V_{PU} - V_{PG}} R_{PGT} \quad (22)$$

When the device is disabled, the output voltage is low, and the PGOOD flag indicates logic low as long as $V_{IN} > 2 \text{ V}$.

7.3.13 Overcurrent and Short-Circuit Protection

The LM73605/6 is protected from overcurrent conditions with cycle-by-cycle current limiting on both HS and LS MOSFETs.

The HS switch is turned off when HS current goes beyond the peak current limit, I_{HS_LIMIT} . The LS switch can only be turned off when LS current is below LS current limit, I_{LS_LIMIT} . If the LS switch current is higher than I_{LS_LIMIT} at the end of a switching cycle, the switching cycle is extended until the LS current reduces below the limit.

Current limiting on both HS and LS switches provides tighter control of the maximum DC inductor current, or output current. They also help prevent runaway current at extreme conditions. With LM73605/6, the maximum output current is always limited at

$$I_{DC_LIMIT} = (I_{HS_LIMIT} + I_{LS_LIMIT}) / 2 \quad (23)$$

The LM73605/6 employs hiccup current protection at extreme overload conditions, including short-circuit condition. Hiccup is only activated when V_{OUT} droops below 40% (typical) of the regulation voltage and stays below for 128 consecutive switching cycles. Under overcurrent conditions when V_{OUT} has not fallen below 40% of regulation, the LM73605/6 continues operation with cycle-by-cycle HS and LS current limiting.

Hiccup is disabled during soft-start. When hiccup is triggered, the device turns off V_{OUT} regulation and re-tries soft start after a re-try delay time, $T_{OC} = 46$ ms (typical). The long wait time allows the device, and the load, to cool down under such fault conditions. If the fault condition still exists when re-try, hiccup shuts down the device and repeats the wait and re-try cycle. If the fault condition has been removed, the device starts up normally.

If tracking was used for initial sequencing, the device restarts using the internal soft-start ramp. Hiccup mode helps to reduce the device power dissipation and die temperature under severe overcurrent conditions and short circuits. It improves system reliability and prolongs the life span of the device.

In FPWM mode, negative current protection is implemented to protect the switches from extreme negative currents. When LS switch current reaches I_{NEG_LIMIT} , LS switch turns off, and HS switch turns on to conduct the negative current. HS switch is turned off once its current reaches 0 A.

7.3.14 Thermal Shutdown

Thermal shutdown protection prevents the device from extreme junction temperature. The device is turned off when the junction temperature exceeds 160°C (typical). After thermal shutdown occurs, hysteresis prevents the device from switching until the junction temperature drops to approximately 135°C. When the junction temperature falls below 135°C, the LM73605/6 restarts.

7.4 Device Functional Modes

7.4.1 Shutdown Mode

The EN pin provides electrical on/off control of the device. When the EN pin voltage is below $V_{EN_VCC_L}$, the device is in shutdown mode. The LDO output voltage $V_{CC} = 0$ V and the output voltage $V_{OUT} = 0$ V. In shutdown mode the quiescent current drops to a very low value.

7.4.2 Standby Mode

The internal LDO has a lower EN threshold than that required to start the regulator. When the EN pin voltage is above $V_{EN_VCC_H}$, the internal LDO regulates the VCC voltage. The precision enable circuitry is turned on once V_{CC} is above V_{CC_UVLO} . The device is in standby mode if EN voltage is below $V_{EN_VOUT_H}$. The internal MOSFETs remains in tri-state unless the voltage on EN pin goes beyond $V_{EN_VOUT_H}$ threshold. The LM73605/6 also employs UVLO protection. If the VCC voltage is below the V_{CC_UVLO} level, the output of the regulator is turned off.

7.4.3 Active Mode

The LM73605/6 is in active mode when the EN voltage is above $V_{EN_VOUT_H}$, and V_{CC} is above V_{CC_UVLO} . The simplest way to enable the operation of the LM73605/6 is to pull up the EN pin to PVIN which allows self-start-up when the input voltage ramps up.

In active mode, depending on the load current and mode setting, the LM73605/6 is in one of four modes:

1. CCM with fixed switching frequency when load current is above half of the peak-to-peak inductor current ripple;

Device Functional Modes (continued)

2. DCM with fixed switching frequency when load current is lower than half of the peak-to-peak inductor current ripple in CCM operation;
3. PFM when switching frequency is decreased at very light load;
4. Under overcurrent or overtemperature conditions, the device operates in one of the fault protection modes.

Please refer to [Table 2](#) for mode-setting details.

7.4.3.1 CCM Mode

In continuous conduction mode (CCM) operation, inductor current has a continuous triangular waveform. The HS switch is on at the beginning of a switching cycle and the LS switch is turned off the end of each switching cycle. In auto mode, the LM73605/6 operates in CCM when the load current is higher than $\frac{1}{2}$ of the peak-to-peak inductor current ($I_{L\text{ripple}}$). In FPWM mode, the LM73605/6 operates in CCM regardless of load.

In CCM operation, the switching frequency is typically constant, unless $t_{\text{ON_MIN}}$, $t_{\text{OFF_MIN}}$, or $I_{\text{PEAK_MIN}}$ conditions are met. The constant switching frequency is determined by RT setting, or the external synchronization clock frequency. The duty cycle is also constant in CCM: $D = V_{\text{OUT}} / V_{\text{IN}}$ if loss is ignored, regardless of load. The peak-to-peak inductor ripple is constant with the same V_{IN} and V_{OUT} , regardless of load.

With very high or very low supply voltages, when the $t_{\text{ON_MIN}}$ or $t_{\text{OFF_MIN}}$ condition is met, the frequency reduces to maintain V_{OUT} regulation with even higher or lower V_{IN} , respectively. When the $I_{\text{PEAK_MIN}}$ condition is met in auto mode, switching frequency will fold back to provide higher efficiency. $I_{\text{PEAK_MIN}}$ is disabled in FPWM mode.

7.4.3.2 DCM Mode

Discontinuous conduction mode (DCM) operation only happens in auto mode, when the load current is lower than half of the CCM inductor current ripple, and peak current is higher than $I_{\text{PEAK_MIN}}$. There is no DCM in FPWM mode. DCM is also known as diode emulation mode. The LS FET is turned off when the inductor current ramps to 0 A. DCM has the same switching frequency as CCM, which is set by the RT pin. Duty cycle and peak current reduces with lighter load in DCM. DCM is more efficient than FPWM under the same condition, because of lower switching losses and lower conduction losses. When the peak current reduces to $I_{\text{PEAK_MIN}}$ at lighter load, the LM73605/6 operates in PFM mode.

7.4.3.3 PFM Mode

Pulse-frequency-modulation (PFM) mode is activated when peak current is lower than $I_{\text{PEAK_MIN}}$, only in auto mode. Peak current is kept constant and V_{OUT} is regulated by frequency. Efficiency is greatly improved by lowered switching losses, especially at very light loads.

In PFM operation, a small DC positive offset appears on V_{OUT} . The lower the frequency is folded back in PFM, the more the DC offset is on V_{OUT} . See V_{OUT} regulation curves in [Application Curves](#). If the DC offset on V_{OUT} is not acceptable, a dummy load at V_{OUT} , or lower R_{FET} and R_{FBB} resistance values can be used to reduce the offset. Alternatively the device can be run in FPWM mode where the switching frequency is constant, and no offset is added to affect the V_{OUT} accuracy unless $t_{\text{ON_MIN}}$ is reached.

7.4.3.4 Fault Protection Mode

The LM73605/6 has hiccup current protection at extreme overload and short circuit conditions. Hiccup is activated when V_{OUT} droops below 40% (typical) of the regulation voltage and stays for 128 consecutive switching cycles. Hiccup is disabled during soft start. In hiccup, the device turns off V_{OUT} and re-tries soft start after 46-ms wait time. Cycle repeats until overcurrent fault condition has been removed. Hiccup mode helps to reduce the device power dissipation and die temperature under severe overcurrent conditions and short circuits. It improves system reliability and prolongs the life span of the device.

Under overcurrent conditions when V_{OUT} droops below regulation but above 40% of regulated voltage, the LM73605/6 stays in cycle-by-cycle HS and LS current limiting protection mode.

Thermal shutdown prevents the device from extreme junction temperature by turning off the device when the junction temperature exceeds 160°C (typical). After thermal shutdown occurs, hysteresis prevents the device from switching until the junction temperature drops to approximately 135°C. When the junction temperature falls below 135°C, the LM73605/6 restarts.

8 Application and Implementation

NOTE

Information in the following applications sections is not part of the TI component specification, and TI does not warrant its accuracy or completeness. TI's customers are responsible for determining suitability of components for their purposes. Customers should validate and test their design implementation to confirm system functionality.

8.1 Application Information

The LM73605/6 is a step-down DC-DC voltage regulator. It is designed to operate with a wide supply voltage range (3.5 V to 36 V), wide switching frequency range (350 kHz to 2.2 MHz), and wide output voltage range: up to 95% V_{IN} . It is a synchronous converter with both HS and LS MOSFETs integrated, and capable of delivering a maximum output current of 5 A (LM73605) or 6 A (LM73606). The following design procedure can be used to select component values for the LM73605/6. Alternately, the WEBENCH® software may be used to generate a complete design. The WEBENCH® software uses an iterative design procedure and accesses a comprehensive database of components when generating a design (see [Custom Design With WEBENCH® Tools](#)). This section presents a simplified discussion of the design process.

8.2 Typical Application

The LM73605/6 only requires a few external components to perform high efficiency power conversion, as shown in [Figure 25](#).

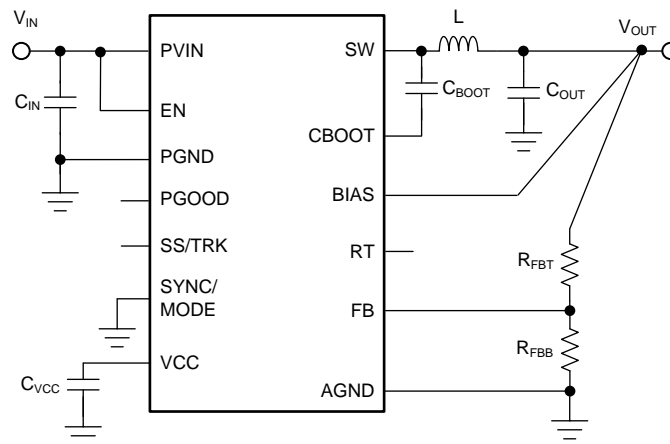

Copyright © 2017, Texas Instruments Incorporated

Figure 25. LM73605/6 Basic Schematic

The LM73605/6 also integrates many practical features to meet a wide range of system design requirements and optimization, such as UVLO, programmable soft-start time, start-up tracking, programmable switching frequency, clock synchronization and a power-good flag. Note that for ease of use, the feature pins do not require an additional component when not in use. They can be either left floating or shorted to ground as defined in .

A comprehensive schematic with all features utilized is shown in [Figure 26](#).

Typical Application (continued)

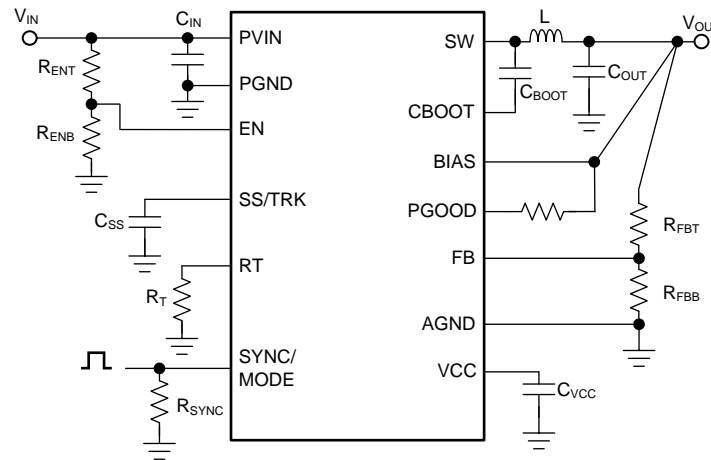

Copyright © 2017, Texas Instruments Incorporated

Figure 26. LM73605/6 Comprehensive Schematic with All Features Utilized

The external components must fulfill not only the needs of the power conversion, but also the stability criteria of the control loop. The LM73605/6 is optimized to work with a range of external components. can be used to for quick component selection.

Table 3. Typical Component Selection

f_{sw} (kHz)	V_{OUT} (V)	L (μ H)	C_{OUT} (μ F) ⁽¹⁾	R_{FBT} (k Ω)	R_{FBB} (k Ω)	RT (k Ω)
350	1	2.2	500	100	OPEN	115
500	1	1.5	400	100	OPEN	78.7 or open
1000	1	0.68	200	100	OPEN	39.2
2200	1	0.47	100	100	OPEN	17.4
350	3.3	4.7	200	100	43.5	115
500	3.3	3.3	150	100	43.5	78.7 or open
1000	3.3	1.8	88	100	43.5	39.2
2200	3.3	1.2	44	100	43.5	17.4
350	5	6.8	120	100	25	115
500	5	4.7	88	100	25	78.7 or open
1000	5	3.3	66	100	25	39.2
2200	5	2.2	44	100	25	17.4
350	12	15	66	100	9.1	115
500	12	10	44	100	9.1	78.7 or open
1000	12	6.8	22	100	9.1	39.2
350	24	22	40	100	4.3	115
500	24	15	30	100	4.3	78.7 or open

(1) All the C_{OUT} values are after derating. Add more when using ceramics.

8.2.1 Design Requirements

Detailed design procedure is described based on a design example. For this design example, use the parameters listed in [Table 4](#).

Table 4. Design Example Parameters

DESIGN PARAMETER	VALUE
Typical input voltage	12 V
Output voltage	5 V
Output current	5 A
Operating frequency	500 kHz
Soft-start time	11 ms

8.2.2 Detailed Design Procedure

8.2.2.1 Custom Design With WEBENCH® Tools

To create a custom design with the WEBENCH® Power Designer, click the [LM73605](#) or [LM73606](#) device.

1. Start by entering the input voltage (V_{IN}), output voltage (V_{OUT}), and output current (I_{OUT}) requirements.
2. Optimize the design for key parameters such as efficiency, footprint, and cost using the optimizer dial.
3. Compare the generated design with other possible solutions from Texas Instruments.

The WEBENCH Power Designer provides a customized schematic along with a list of materials with real-time pricing and component availability.

In most cases, these actions are available:

- Run electrical simulations to see important waveforms and circuit performance
- Run thermal simulations to understand board thermal performance
- Export customized schematic and layout into popular CAD formats
- Print PDF reports for the design, and share the design with colleagues

Get more information about WEBENCH tools at www.ti.com/WEBENCH.

8.2.2.2 Output Voltage Setpoint

The output voltage of the LM73605/6 device is externally adjustable using a resistor divider network. The divider network is comprised of top feedback resistor R_{FBT} and bottom feedback resistor R_{FBB} . Use [Equation 24](#) to determine the output voltage of the converter.

$$V_{OUT} = V_{FB} \times \left(1 + \frac{R_{FBT}}{R_{FBB}} \right) \quad (24)$$

Typically, $R_{FBT} = 10 \text{ k}\Omega$ to $100 \text{ k}\Omega$ is recommended. Larger R_{FBT} and R_{FBB} values reduce the quiescent current going through the divider, which help maintain high efficiency at very light loads. But larger divider values also make the feedback path more susceptible to noise. If efficiency at very light loads is critical in a certain application, R_{FBT} up to $1 \text{ M}\Omega$ can be used.

$$R_{FBB} = \frac{V_{FB}}{V_{OUT} - V_{FB}} R_{FBT} \quad (25)$$

$R_{FBT} = 100 \text{ k}\Omega$ is selected here. $R_{FBB} = 24.99 \text{ k}\Omega$ can be calculated to get 5-V output voltage.

8.2.2.3 Switching Frequency

The default switching frequency of the LM73605/6 device is set at 500 kHz. For this design, the RT pin can be floating, and the LM73605/6 switches at 500 kHz in CCM mode. An RT resistor of $78.7 \text{ k}\Omega$, calculated using [Equation 13](#), [Figure 21](#), or [Table 1](#), can be connected from RT pin to ground to obtain 500-kHz operation frequency as well.

The LM73605/6 switching action can synchronize to an external clock from 350 kHz to 2.2 MHz. TI recommends connecting an external clock to the SYNC/MODE pin with a 50-Ω to 100-Ω termination resistor. The SYNC/MODE pin must be grounded if not used.

RT pin is floating and SYNC/MODE pin is tied to ground in this design.

8.2.2.4 Input Capacitors

The LM73605/6 device requires high-frequency ceramic input decoupling capacitors. Depending on the application, a bulk input capacitor can also be added. The typical recommended ceramic decoupling capacitors include one small, 0.1 μF to 1 μF, and one large, 10 μF to 22 μF, capacitors. High-quality ceramic type X5R or X7R is recommended. The voltage rating must be greater than the maximum input voltage. As a general rule, to compensate the derating TI recommends a voltage rating of twice the maximum input voltage.

It is very important in buck regulator to place the small decoupling capacitor right next to the PVIN and PGND pins. This capacitor is used to bypass the high frequency switching noise by providing a return path of the noise. It prevents the noise from spreading to wider area of the board. The large bypass ceramic capacitor must also be as close as possible to the PVIN and PGND pins.

Additionally, some bulk capacitance may be required, especially if the LM73605/6 circuit is not located within approximately 2 inches from the input voltage source. This capacitor is used to provide damping to the voltage spike due to the lead inductance of the cable. The optimum value for this capacitor is four times the ceramic input capacitance with ESR close to the characteristic impedance of the LC filter formed by your input inductance and your ceramic input capacitors. It is not critical that the electrolytic filter be at the optimum value for damping, but it must be rated to handle the maximum input voltage including ripple voltage.

For this design, two 10-μF, X7R dielectric capacitors rated for 50 V are used for the input decoupling capacitance, and a capacitor with a value of 0.47 μF for high-frequency filtering.

NOTE

DC bias effect: High capacitance ceramic capacitors have a DC bias derating effect, which will have a strong influence on the final effective capacitance. Therefore, the right capacitor value has to be chosen carefully. Package size and voltage rating in combination with dielectric material are responsible for differences between the rated capacitor value and the effective capacitance.

8.2.2.5 Inductor Selection

The first criterion for selecting an output inductor is the inductance. In most buck converters, this value is based on the desired peak-to-peak ripple current in the inductor, $I_{L_{ripple}}$. An inductance that gives a ripple current of 10% to 30% of the maximum output current (5 A or 6 A) is a good starting point. The inductance can be calculated from [Equation 26](#):

$$L = \frac{(V_{IN} - V_{OUT}) \times D}{f_{SW} \times I_{L_{ripple}}}$$

where

- $I_{L_{ripple}} = (0.1 \text{ to } 0.3) \times I_{L_MAX}$
 - $I_{L_MAX} = 5 \text{ A for LM73605 and } 6 \text{ A for LM73606}$
 - $D = V_{OUT} / V_{IN}$
- (26)

Selected $I_{L_{ripple}}$ is between 10% to 30% of the rated current of the device.

As with switching frequency, the selection of the inductor is a tradeoff between size, cost, and performance. Higher inductance gives lower ripple current and hence lower output voltage ripple. With peak current mode control, the current ripple is the input signal to the control loop. A certain amount of ripple current is needed to maintain the signal to noise ratio of the control loop. Within the same series (same size/height), a larger inductance will have a higher series resistance (ESR). With similar ESR, size and/or height will be greater. Larger inductance also has slower current slew rate during large load transients.

Lower inductance usually results in a smaller, less expensive component; however, the current ripple will be higher, thus more output capacitor is needed to maintain the same amount of output voltage ripple. The RMS current is higher with the same load current due to larger ripple. The switching loss is higher because the switch current, which is the peak current, is higher when the HS switch turns off and LS switch turns on. Core loss of the inductor is also larger with higher ripple. Core loss needs to be considered, especially with higher switching frequencies. Check the ripple current over V_{INMIN} to V_{INMAX} range to make sure current ripple is reasonable over entire supply voltage range.

For applications with large V_{OUT} and typical $V_{OUT}/V_{IN} > 50\%$, sub-harmonic oscillation can be a concern in peak current-mode-controlled buck converters. Select inductance so that

$$L \geq V_{OUT} / (N \times F_{SW})$$

where

- $N = 3$ with LM73605
 - $N = 3.6$ with LM73606
- (27)

The second criterion is inductor saturation current rating. Because the maximum inductor current is limited by the high-side switch current limit, it is advised to select an inductor with a saturation current higher than the $I_{LIMIT-HS}$. TI recommends selection of soft saturation inductors. A power inductor could be the major source of radiated noise. When EMI is a concern in the application, select a shielded inductor, if possible.

For this design, 20% ripple of 5 A yields 5.8- μ H inductance. A 4.7- μ H inductor is selected, which gives 25% ripple current.

8.2.2.6 Output Capacitor Selection

The output capacitor is responsible for filtering the inductor current, and supplying load current during transients. Capacitor selection depends on application conditions as well as ripple and transient requirements. Best performance is achieved by using ceramic capacitors or combinations of ceramic and other types of capacitors. For high output voltage conditions, such as 12 V and above, finding ceramic capacitors that are rated for an appropriate voltage becomes challenging. In such cases choose a low-ESR SP-CAP™™ or POSCAP™-type capacitor. It is a good idea to use a low-value ceramic capacitor in parallel with other capacitors, to bypass high frequency noise between ground and V_{OUT} .

For a given input and output requirement, [Equation 28](#) gives an approximation for a minimum output capacitor required.

$$C_{OUT} > \frac{1}{(f_{SW} \times r \times \Delta V_{OUT} / I_{OUT})} \times \left[\left(\frac{r^2}{12} \times (1 + D') \right) + (D' \times (1 + r)) \right]$$

where

- r = Ripple ratio of the inductor ripple current ($I_{Lripple} / 5$ A or 6 A)
- ΔV_{OUT} = Target output voltage undershoot, for example, 5% to 10% of V_{OUT}

$D' = 1 -$ duty cycle

- f_{SW} = switching frequency
 - I_{OUT} = load current
- (28)

Along with this for the same requirement, calculate the maximum ESR with [Equation 29](#).

$$ESR < \frac{D'}{f_{SW} \times C_{OUT}} \times \left(\frac{1}{r} + 0.5 \right)$$
(29)

The output capacitor is also the dominating factor in the loop response of a peak-current mode controlled buck converter. A simplified estimation of the control loop crossover frequency can be found by [Equation 18](#).

Select C_{OUT} so that the f_x is no higher than 1/6 of the switching frequency. Typically, $f_x / f_{SW} = 1/10$ to $1/8$ provides a good combination of stability and performance.

For this design, one 0.47- μ F, 50-V X7R and four 22- μ F, 16-V, X7R ceramic capacitors are used in parallel.

8.2.2.7 Feed-Forward Capacitor

The LM73605/6 is internally compensated. Typically, select $R_{FBT} \leq 100 \text{ k}\Omega$, then C_{FF} is not needed. When very low quiescent current is needed, $R_{FBT} = 1 \text{ M}\Omega$ may be used. If C_{OUT} is mainly ceramic type low ESR capacitors, an external feed-forward capacitor C_{FF} may be needed to improve the phase margin. Add C_{FF} in parallel with R_{FBT} . C_{FF} is chosen such that the phase boost is maximized at the estimated crossover frequency f_x . [Equation 21](#) was tested.

With this design, because $R_{FBT} = 100 \text{ k}\Omega$ is selected, no C_{FF} is needed.

8.2.2.8 Bootstrap Capacitors

Every LM73605/6 design requires a bootstrap capacitor, C_{BOOT} . The recommended bootstrap capacitor is 0.47 μF and rated at 6.3 V or greater. The bootstrap capacitor is located between the SW pin and the CBOOT pin. The bootstrap capacitor must be a high-quality ceramic type with X7R or X5R grade dielectric for temperature stability.

8.2.2.9 VCC Capacitor

The VCC pin is the output of an internal LDO for LM73605/6. The input for this LDO comes from either V_{IN} or BIAS pin voltage. The recommended C_{VCC} capacitor is 2.2 μF and rated at 6.3 V or greater. It must be a high-quality ceramic type with X7R or X5R grade to insure stability. Never short VCC pin to ground during operation.

8.2.2.10 BIAS

Because $V_{OUT} = 5 \text{ V}$ in this design, the BIAS pin is tied to V_{OUT} to reduce LDO power loss. The output voltage is supplying the LDO current instead of the input voltage. The power saving is $I_{LDO} \times (V_{IN} - V_{OUT})$. The power saving is more significant when $V_{IN} \gg V_{OUT}$ and with higher frequency operation. To prevent V_{OUT} noise and transients from coupling to BIAS, a series resistor, 1 Ω to 10 Ω , may be added between V_{OUT} and BIAS. A bypass capacitor with a value of 1 μF or higher can be added close to the BIAS pin to filter noise.

8.2.2.11 Soft Start

The SS/TRK pin can be floating to start up following the internal soft-start ramp. In order to extend the soft-start time, an external soft-start capacitor can be used. Use [Equation 12](#) in order to calculate the soft-start capacitor value.

With a desired soft-start time $t_{SS} = 11 \text{ ms}$, a soft-start charging current of $I_{SSC} = 2 \mu\text{A}$ (typical), and $V_{FB} = 1.006 \text{ V}$ (typical), [Equation 12](#) yields a soft-start capacitor value of 22 nF.

8.2.2.12 Undervoltage Lockout Setpoint

The system undervoltage lockout (UVLO) is adjusted using the external voltage divider network of R_{ENT} and R_{ENB} . With one selected R_{ENT} value, R_{ENB} can be found by [Equation 10](#).

Note that the divider adds to supply quiescent current by $V_{IN} / (R_{ENT} + R_{ENB})$. Small R_{ENT} and R_{ENB} values add more quiescent current loss. However, large divider values make the node more sensitive to noise.

In this design, EN pin is tied to PVIN pin with a 100-k Ω resistor.

8.2.2.13 PGOOD

For this design, a 100-k Ω resistor is used to pull up PGOOD to V_{OUT} .

8.2.3 Application Curves

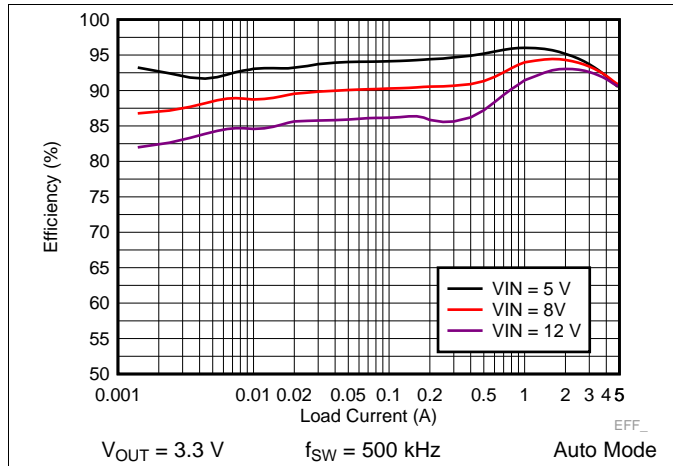

Figure 27. LM73605 Efficiency

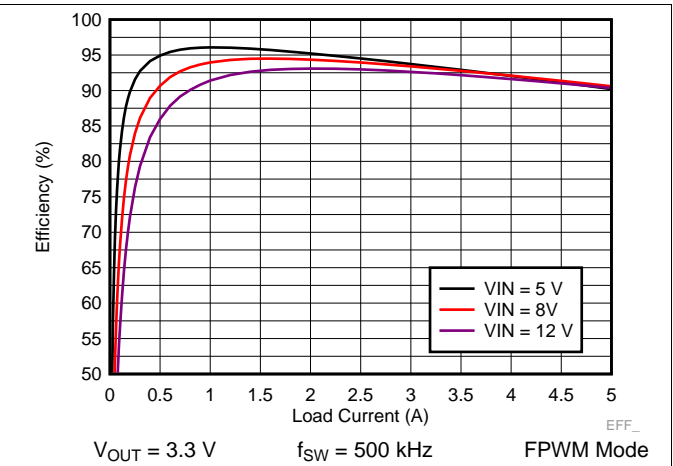

Figure 28. LM73605 Efficiency

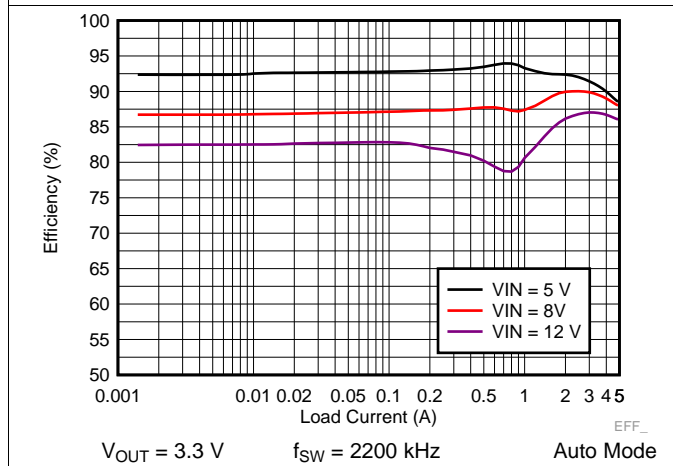

Figure 29. LM73605 Efficiency

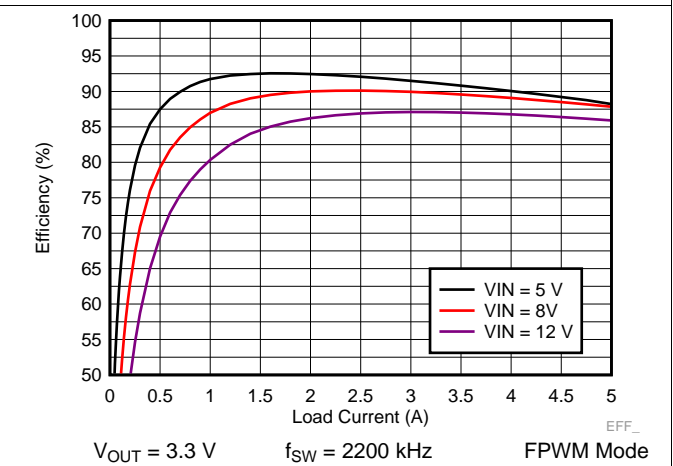

Figure 30. LM73605 Efficiency

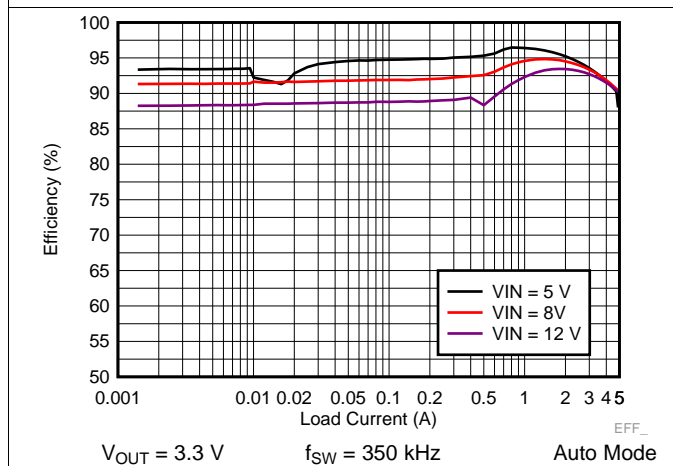

Figure 31. LM73605 Efficiency

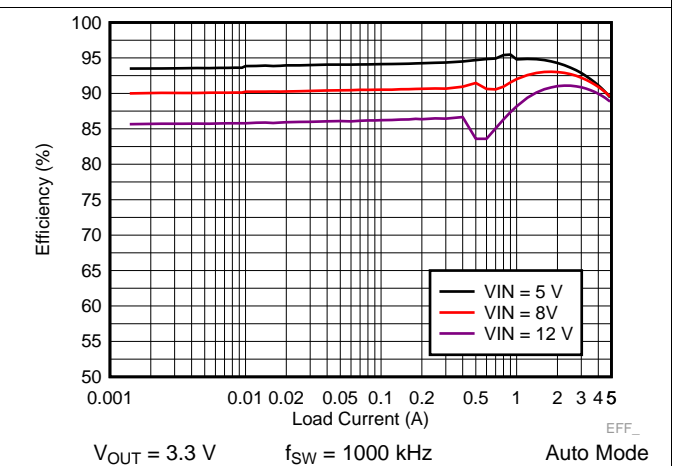
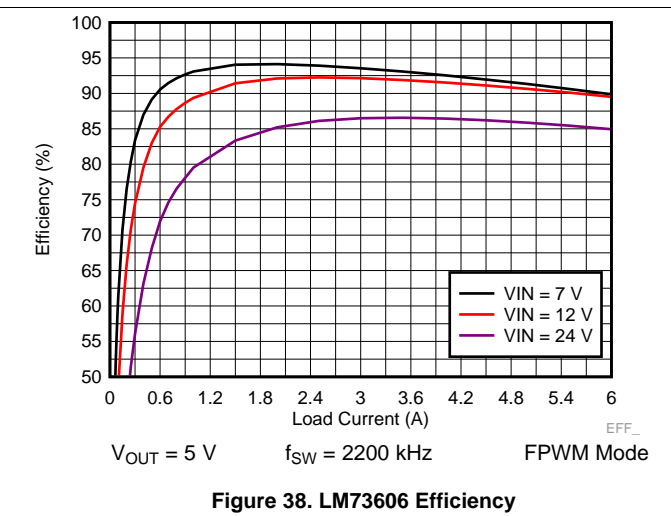
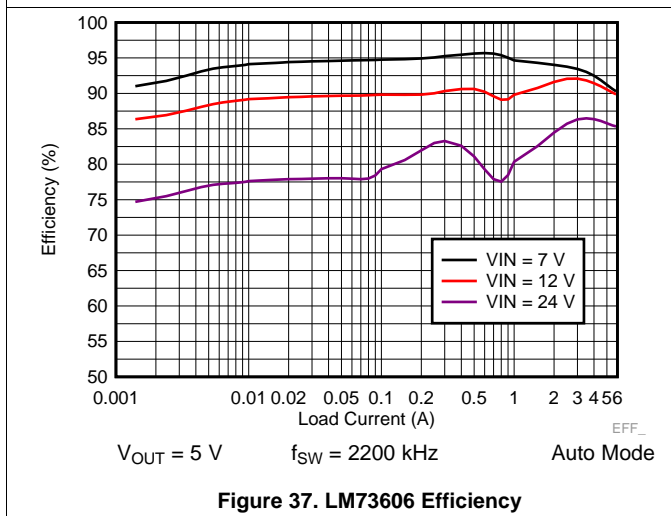
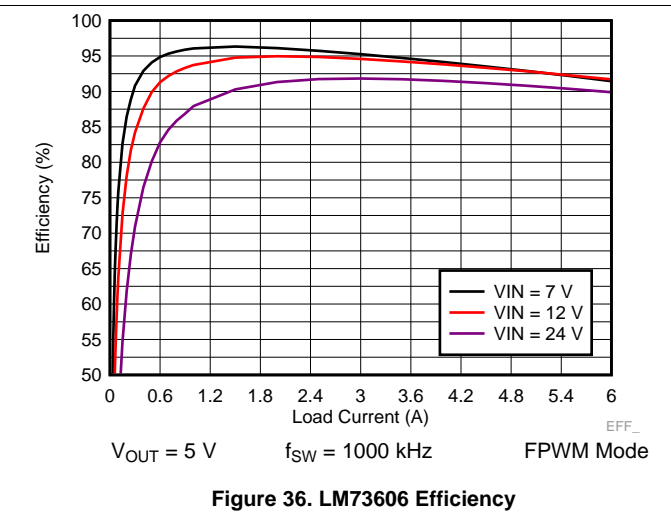
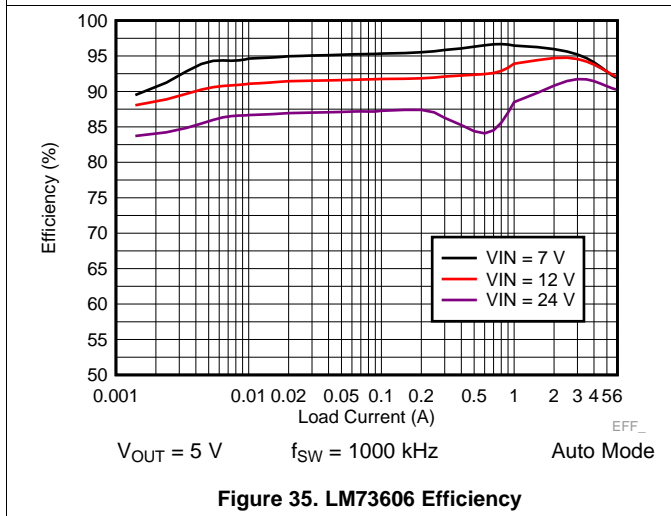
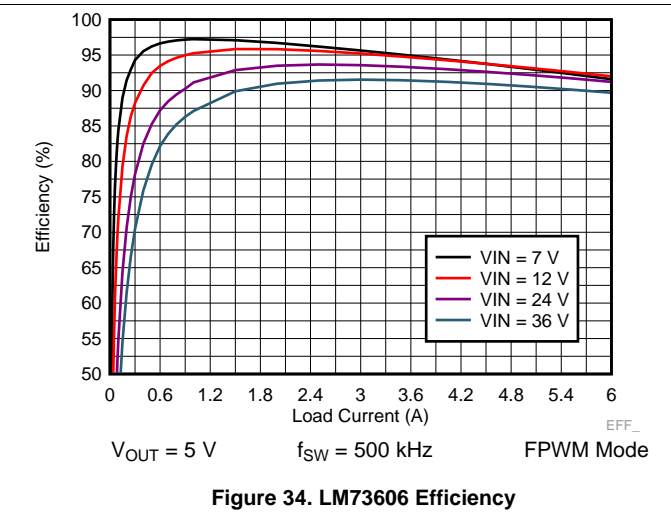
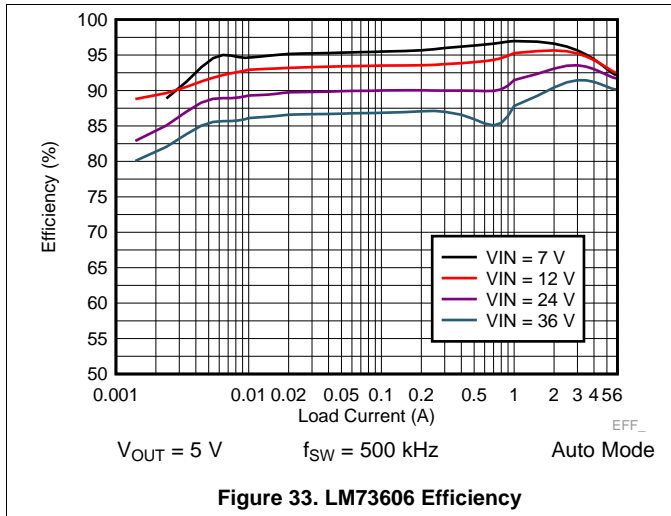
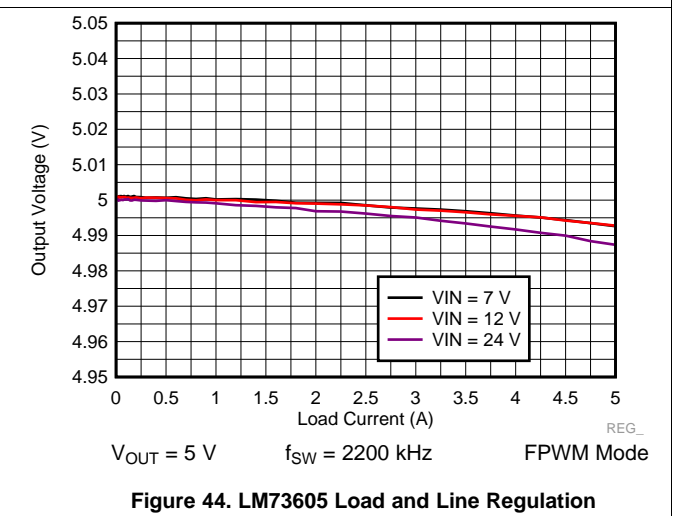
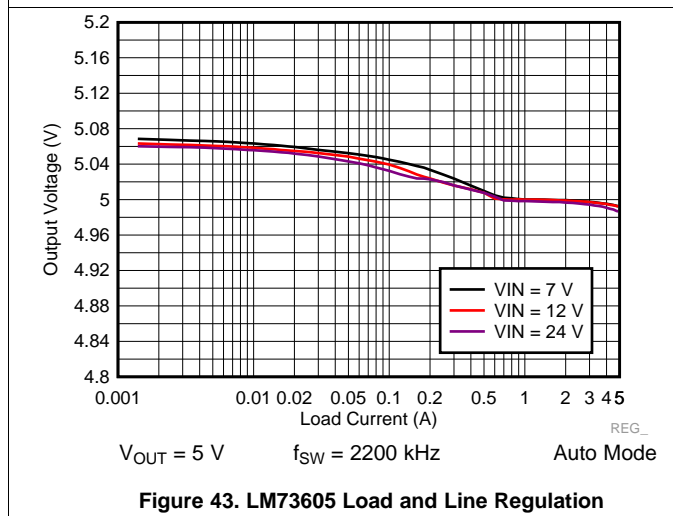
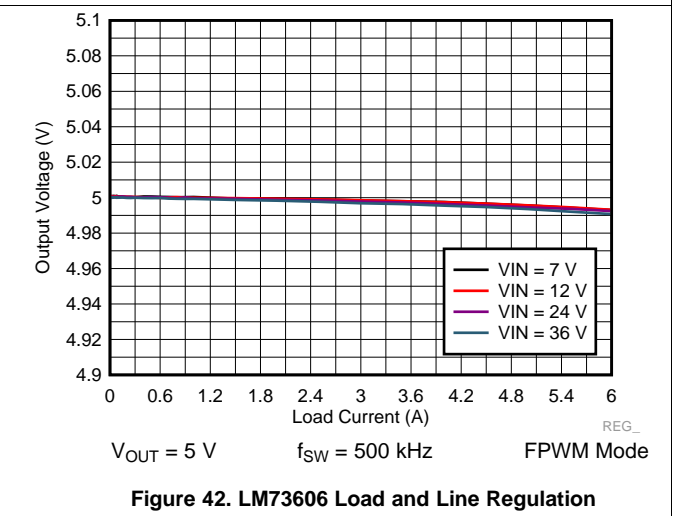
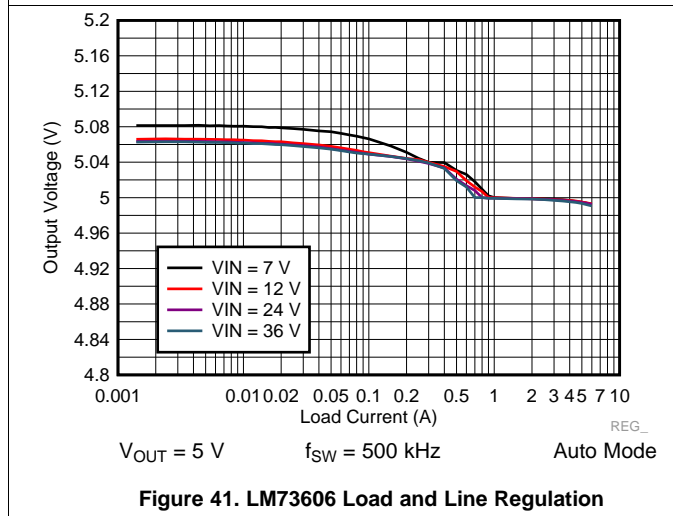
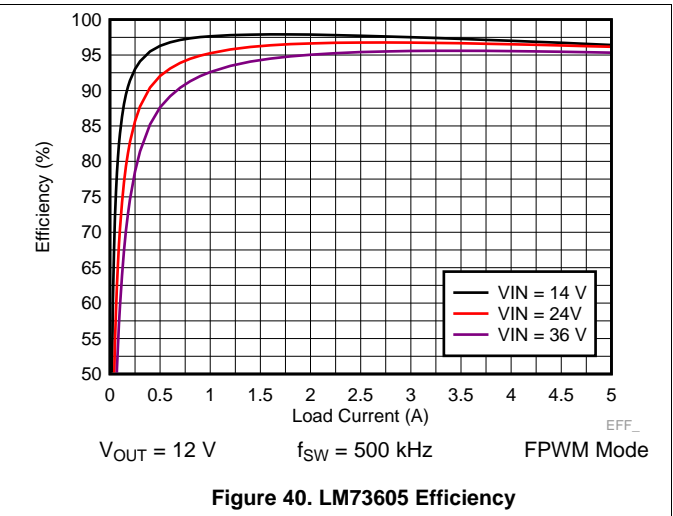
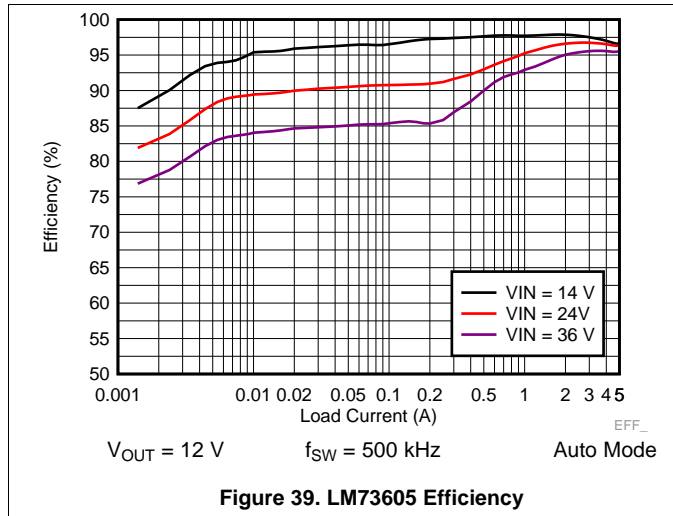

Figure 32. LM73605 Efficiency





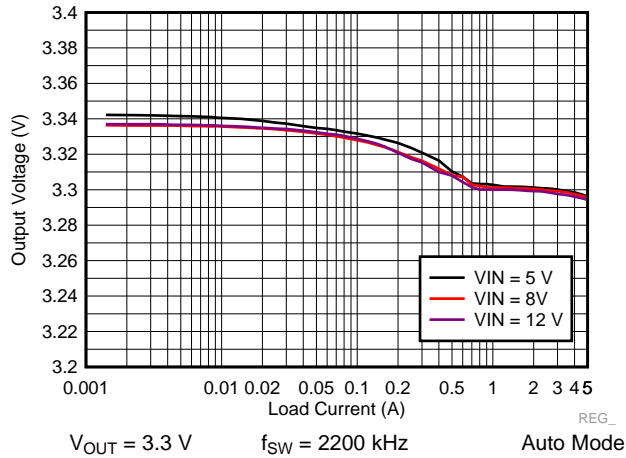

Figure 45. LM73605 Load and Line Regulation

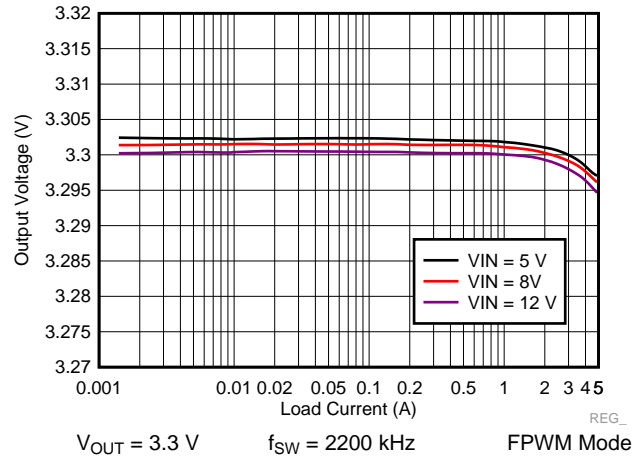

Figure 46. LM73605 Load and Line Regulation

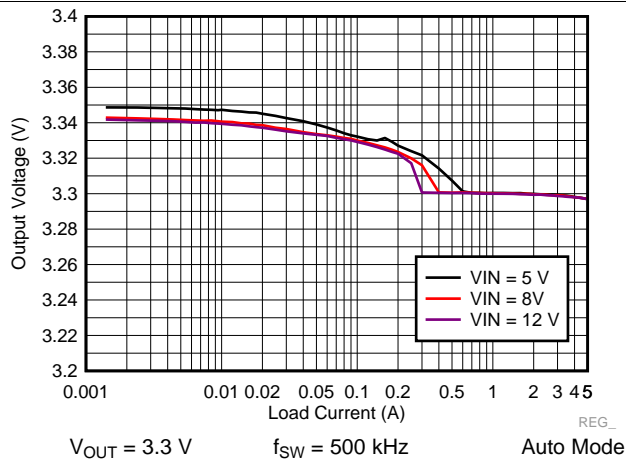

Figure 47. LM73605 Load and Line Regulation

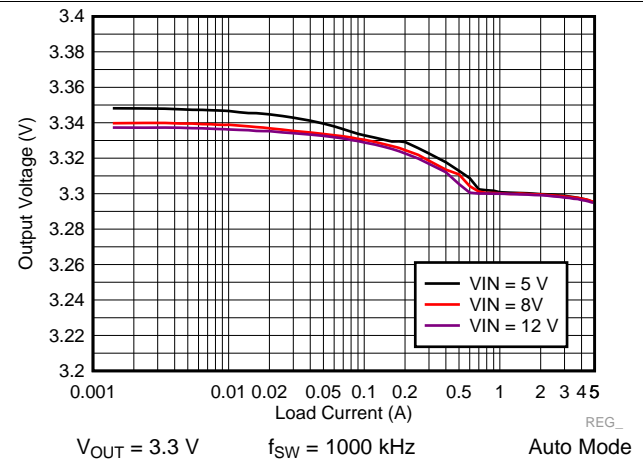

Figure 48. LM73605 Load and Line Regulation

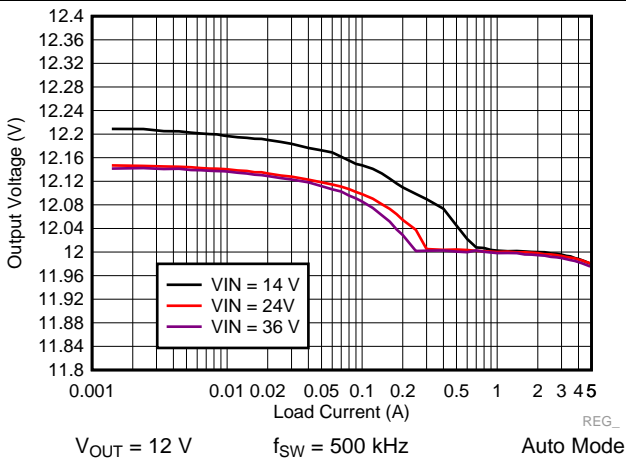

Figure 49. LM73605 Load and Line Regulation

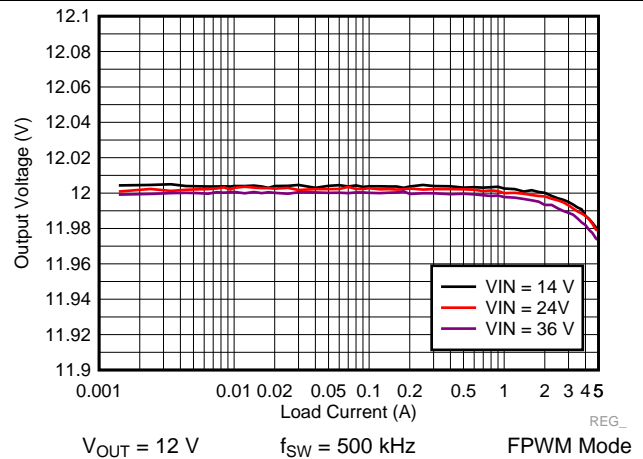

Figure 50. LM73605 Load and Line Regulation

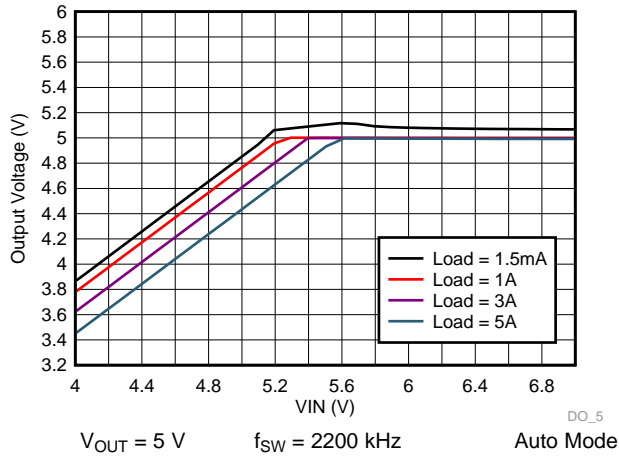

Figure 51. LM73605 Dropout Curve

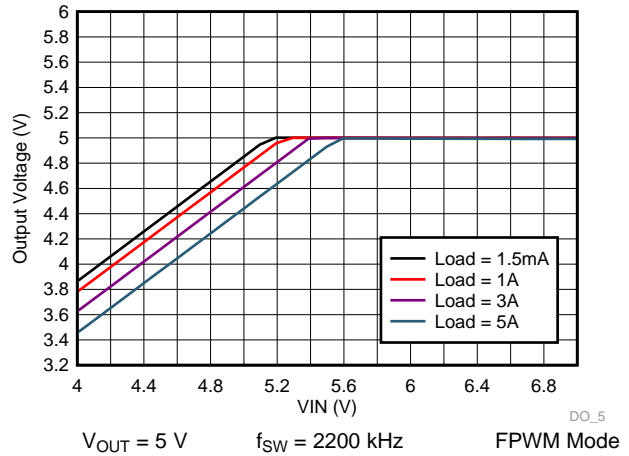

Figure 52. LM73605 Dropout Curve

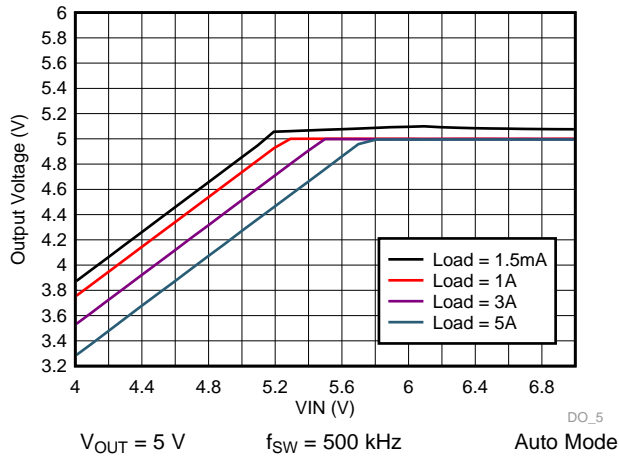

Figure 53. LM73605 Dropout Curve

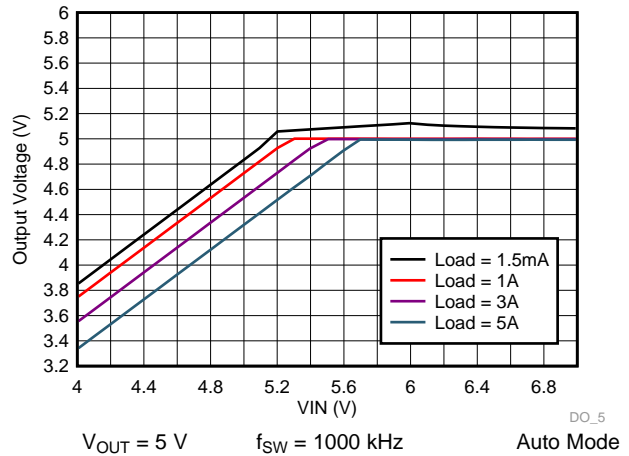

Figure 54. LM73605 Dropout Curve

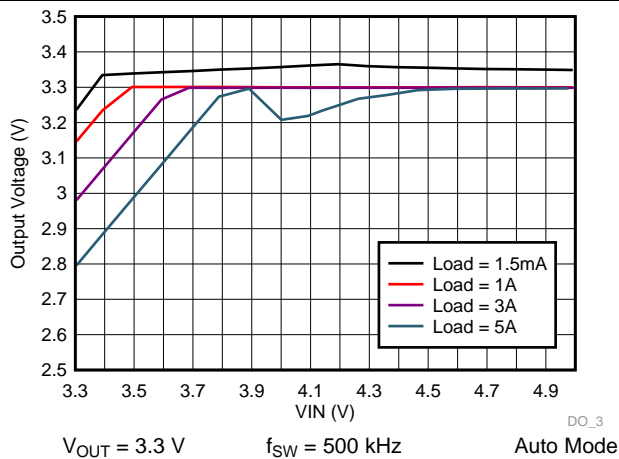

Figure 55. LM73605 Dropout Curve

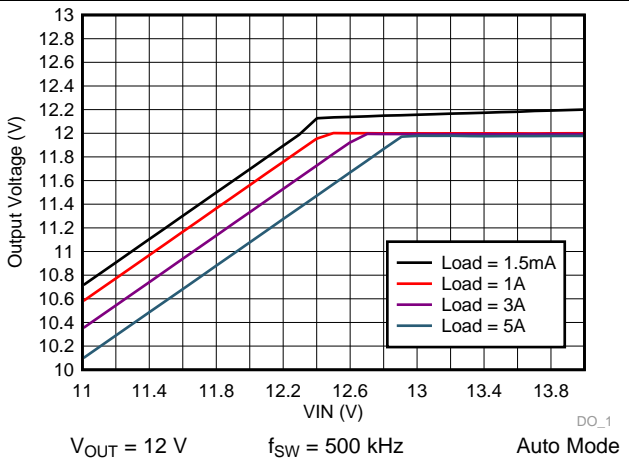
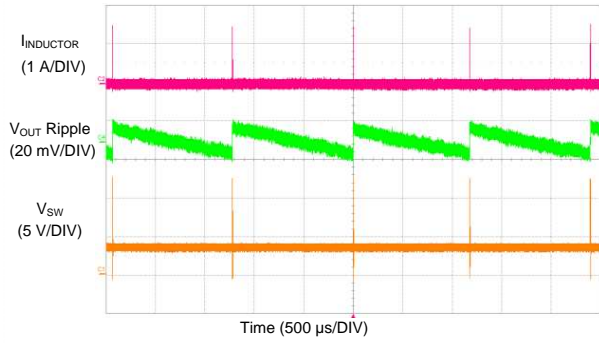
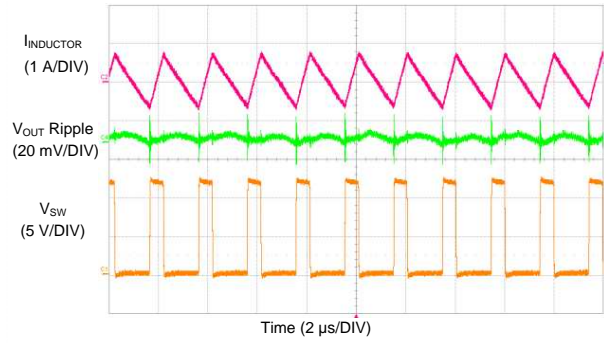

Figure 56. LM73605 Dropout Curve



$V_{IN} = 12\text{ V}$ $V_{OUT} = 3.3\text{ V}$ $f_{SW} = 500\text{ kHz}$
 $I_{OUT} = 1\text{ mA}$ Auto Mode

Figure 57. LM73606 Switching Waveform and V_{OUT} Ripple



$V_{IN} = 12\text{ V}$ $V_{OUT} = 3.3\text{ V}$ $f_{SW} = 500\text{ kHz}$
 $I_{OUT} = 1\text{ mA}$ FPWM Mode

Figure 58. LM73606 Switching Waveform and V_{OUT} Ripple

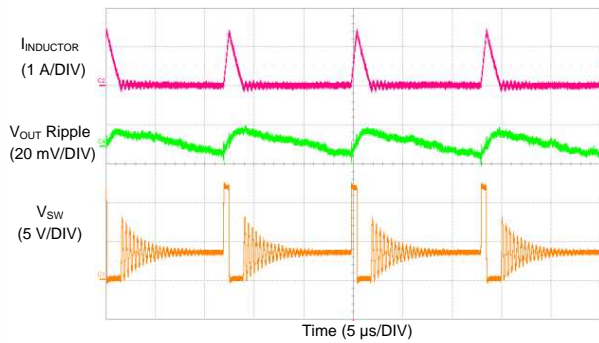

$V_{IN} = 12\text{ V}$ $V_{OUT} = 3.3\text{ V}$ $f_{SW} = 500\text{ kHz}$
 $I_{OUT} = 100\text{ mA}$ Auto Mode

Figure 59. LM73606 Switching Waveform and V_{OUT} Ripple

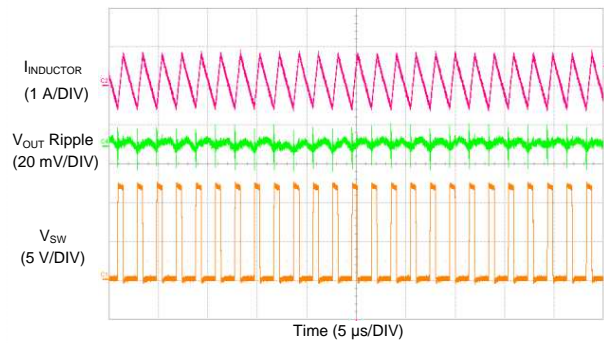

$V_{IN} = 12\text{ V}$ $V_{OUT} = 3.3\text{ V}$ $f_{SW} = 500\text{ kHz}$
 $I_{OUT} = 100\text{ mA}$ FPWM Mode

Figure 60. LM73606 Switching Waveform and V_{OUT} Ripple

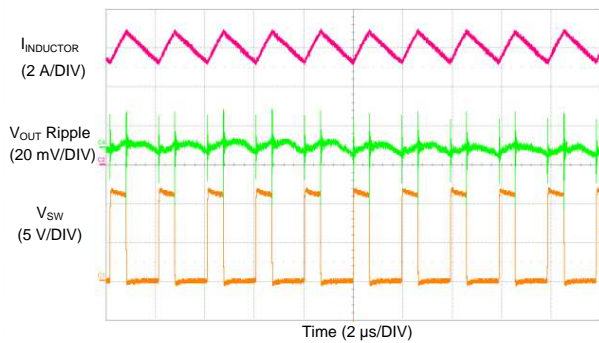

$V_{IN} = 12\text{ V}$ $V_{OUT} = 3.3\text{ V}$ $f_{SW} = 500\text{ kHz}$
 $I_{OUT} = 6\text{ A}$ Auto Mode

Figure 61. LM73606 Switching Waveform and V_{OUT} Ripple

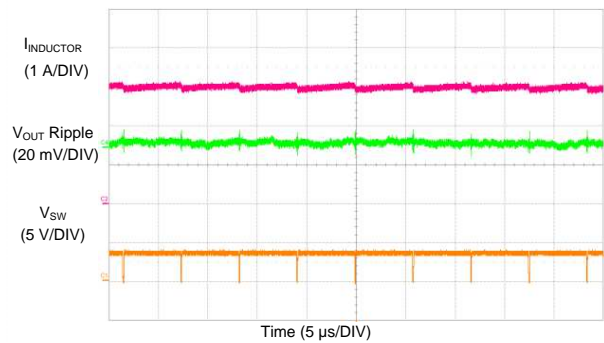

$V_{IN} = 3.66\text{ V}$ $V_{OUT} = 3.3\text{ V}$ f_{SW} set at 500 kHz
 $I_{OUT} = 3\text{ A}$ Auto Mode

Figure 62. LM73606 Switching Waveform at Dropout

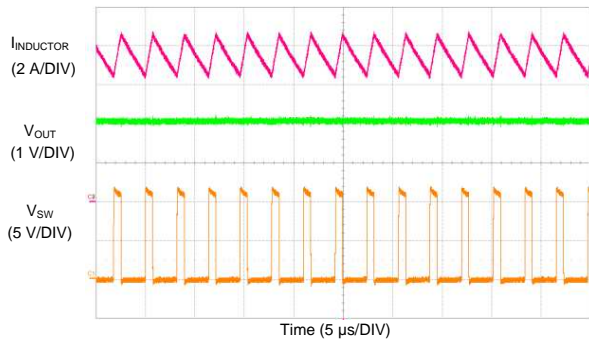

$V_{IN} = 12\text{ V}$ V_{OUT} set at 3.3 V f_{SW} set at 500 kHz
 $I_{OUT} = 7.5\text{ A}$ V_{OUT} droops to 2 V

Figure 63. LM73606 Overcurrent Behavior

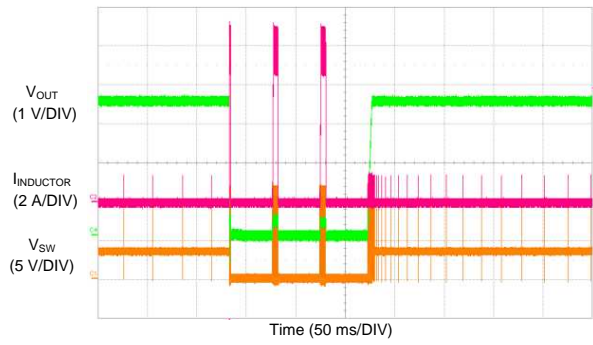

$V_{IN} = 12\text{ V}$ $V_{OUT} = 3.3\text{ V}$ $f_{SW} = 500\text{ kHz}$

Figure 64. LM73606 Short-Circuit Hiccup Protection and Recovery

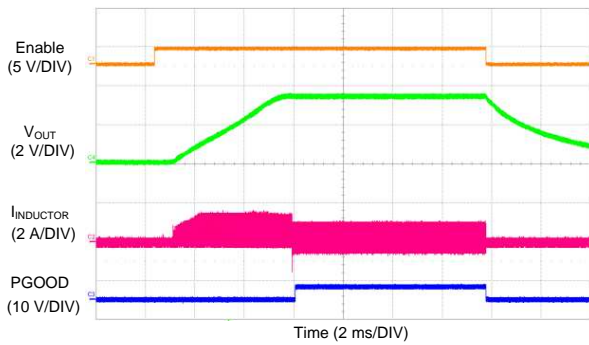

$V_{IN} = 12\text{ V}$ $V_{OUT} = 3.3\text{ V}$ $f_{SW} = 500\text{ kHz}$
 $I_{OUT} = 200\text{ mA}$ FPWM Mode

Figure 65. LM73606 Soft Start With 200-mA Load in FPWM Mode

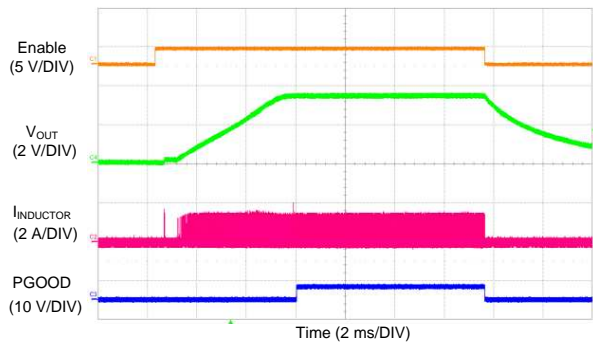

$V_{IN} = 12\text{ V}$ $V_{OUT} = 3.3\text{ V}$ $f_{SW} = 500\text{ kHz}$
 $I_{OUT} = 200\text{ mA}$ Auto Mode

Figure 66. LM73606 Soft Start With 200-mA Load in Auto Mode

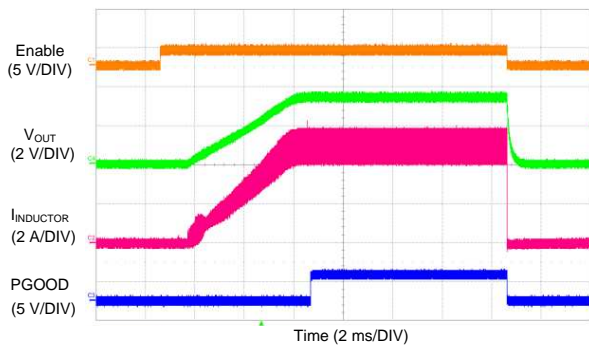

$V_{IN} = 12\text{ V}$ $V_{OUT} = 3.3\text{ V}$ $f_{SW} = 500\text{ kHz}$
 $I_{OUT} = 5\text{ A}$ Auto Mode

Figure 67. LM73606 Soft Start With 5-A Load

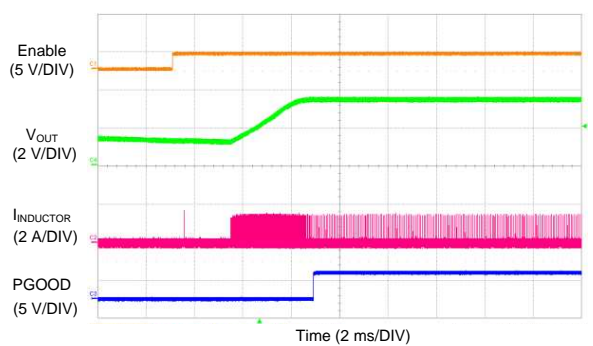

$V_{IN} = 12\text{ V}$ $V_{OUT} = 3.3\text{ V}$ $f_{SW} = 500\text{ kHz}$
 $V_{PRE-BIAS} = 1.5\text{ V}$ Auto Mode

Figure 68. LM73606 Soft Start With Pre-Biased Output Voltage

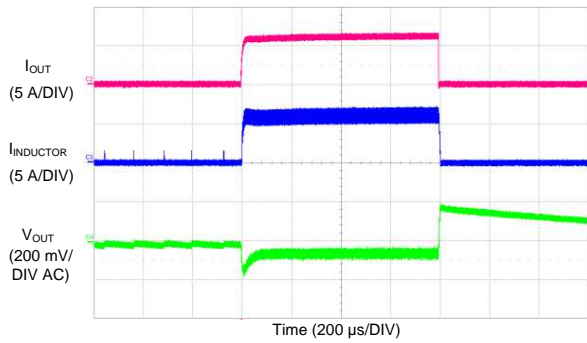

$V_{IN} = 12\text{ V}$ $V_{OUT} = 3.3\text{ V}$ $f_{SW} = 500\text{ kHz}$
 $I_{OUT} = 10\text{ mA to } 6\text{ A to } 10\text{ mA}$ Auto Mode

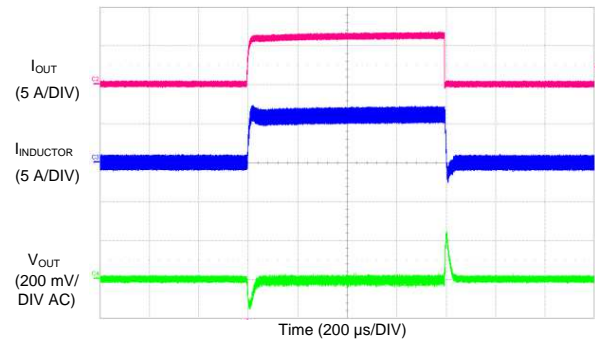
Figure 69. LM73606 Load Transients

$V_{IN} = 12\text{ V}$ $V_{OUT} = 3.3\text{ V}$ $f_{SW} = 500\text{ kHz}$
 $I_{OUT} = 10\text{ mA to } 6\text{ A to } 10\text{ mA}$ FPWM Mode

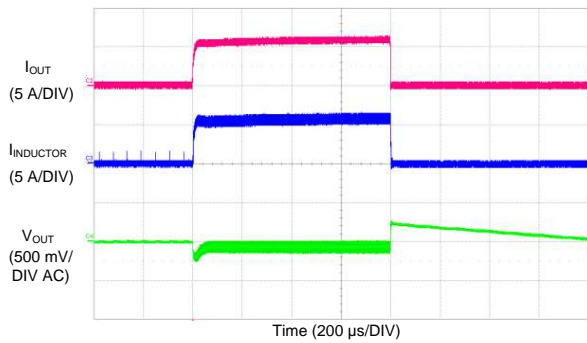
Figure 70. LM73606 Load Transients

$V_{IN} = 12\text{ V}$ $V_{OUT} = 5\text{ V}$ $f_{SW} = 2200\text{ kHz}$
 $I_{OUT} = 10\text{ mA to } 5\text{ A to } 10\text{ mA}$ Auto Mode

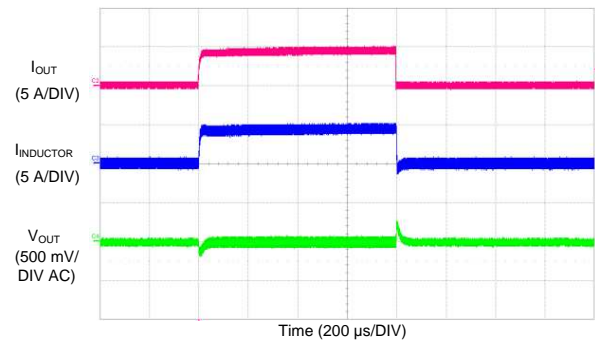
Figure 71. LM73605 Load Transients

$V_{IN} = 12\text{ V}$ $V_{OUT} = 5\text{ V}$ $f_{SW} = 2200\text{ kHz}$
 $I_{OUT} = 10\text{ mA to } 5\text{ A to } 10\text{ mA}$ FPWM Mode

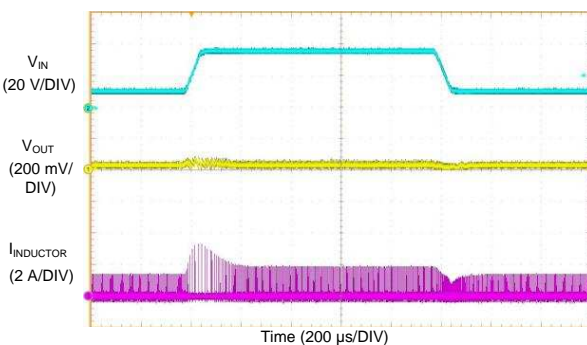
Figure 72. LM73605 Load Transients

$I_{OUT} = 100\text{ mA}$ $V_{OUT} = 3.3\text{ V}$ $f_{SW} = 500\text{ kHz}$
 $V_{IN} = 10\text{ V to } 35\text{ V to } 10\text{ V}$ Auto Mode

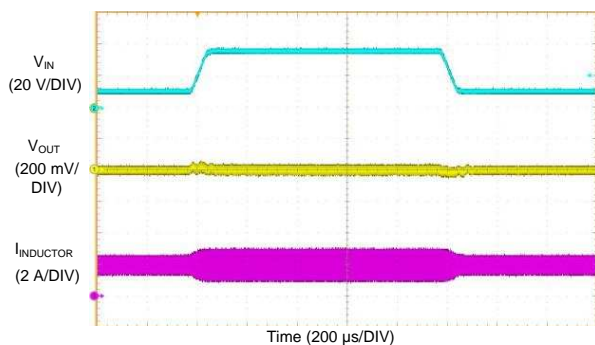
Figure 73. LM73606 Line Transients

$I_{OUT} = 2\text{ A}$ $V_{OUT} = 3.3\text{ V}$ $f_{SW} = 500\text{ kHz}$
 $V_{IN} = 10\text{ V to } 35\text{ V to } 10\text{ V}$ Auto Mode

Figure 74. LM73606 Line Transients

9 Power Supply Recommendations

The LM73605/6 is designed to operate from an input voltage supply range from 3.5 V to 36 V. This input supply must be able to withstand the maximum input current and maintain a voltage above 3.5 V at the PVIN pin. The resistance of the input supply rail must be low enough that an input current transient does not cause a high enough drop at the LM73605/6 supply voltage that can cause a false UVLO fault triggering and system reset. If the input supply is located more than a few inches from the LM73605/6, additional bulk capacitance may be required in addition to the ceramic bypass capacitors. A 47- μ F or 100- μ F electrolytic capacitor is a typical choice.

10 Layout

10.1 Layout Guidelines

The performance of any switching converter depends heavily upon the layout of the PCB. Use the following guidelines to design a PCB layout with optimum power conversion performance, EMI performance, and thermal performance.

1. Place ceramic high frequency bypass capacitors as close as possible to the PVIN and PGND pins, which are right next to each other on the package. Place the small value ceramic capacitor closest to the pins. This is very important for EMI performance.
2. Use short and wide traces, or localized IC layer planes, for high current paths, such as V_{IN} , V_{OUT} , SW and GND connections. Short and wide copper traces reduce power loss and noise due to low parasitic resistances and inductances. Wide copper traces also help reduce die temperature, because they also provide wide heat dissipation paths. Use thick copper (2 oz) on high current layer(s) if possible.
3. Confine pulsing current paths (V_{IN} , SW, and ground return for V_{IN}) on the device layer as much as possible to prevent switching noises from contaminating other layers.
4. C_{BOOT} capacitor also contains pulsing current. Place C_{BOOT} close to the pin and route to SW with short trace. The pinout of the device makes it easy to optimize the C_{BOOT} placement and routing.
5. Use a solid ground plane at the layer right underneath the device as a noise shielding and heat dissipation path.
6. Place the VCC bypass capacitor close to the VCC pin. Tie the ground pad of the capacitor to the ground plane using a via right next to it.
7. Use via next to AGND pin to the ground plane.
8. Minimize trace length to the FB pin. Both feedback resistors must be located right next to the FB pin. Tie the ground side of R_{FBB} to the ground plane with a via right next to it. Place C_{FF} directly in parallel with R_{FBT} if used.
9. If V_{OUT} accuracy at the load is important, make sure the V_{OUT} sense point is made close to the load. Route V_{OUT} sense to R_{FBT} through a path away from noisy nodes and preferably on a layer on the other side of the ground plane. If BIAS is connected to V_{OUT} , do not use the same trace to route V_{OUT} to BIAS and to R_{FBT} . BIAS current contains pulsing driver current and it changes with operating mode. Use separated traces for BIAS and V_{OUT} sense to optimize V_{OUT} regulation accuracy.
10. Provide adequate device heat sinking. Use an array of heat-sinking vias to connect the exposed pad to the ground plane and the bottom PCB layer. Connect the DAP and NC pins on the short sides of the device to the GND net, so that IC layer ground copper can provide an optimal dog-bone shape heat sink. Heat generated on the die can flow directly from device junction to the DAP then to the copper and spread to the wider copper outside of the device. Try to keep copper area solid on the top and bottom layer around thermal vias on the DAP to optimize heat dissipation.

Layout Guidelines (continued)

10.1.1 Layout For EMI Reduction

To optimize EMI performance, place the components in the high di/dt current path, as shown in [Figure 75](#), as close as possible to each other. When the components are close to each other, the area of the loop enclosed by these components, and the parasitic inductance of this loop, are minimized. The noises generated by the pulsing current and parasitic inductances are then minimized.

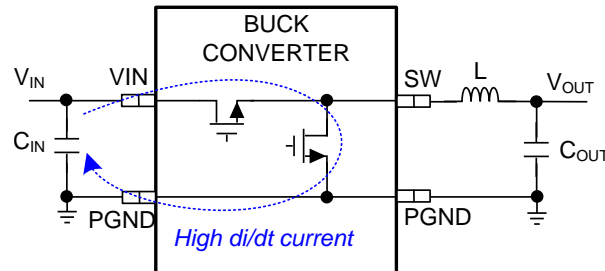

Figure 75. Pulsing Current Path of Buck Converter

In a buck converter, the high di/dt current path is composed of the HS and LS MOSFETs and the input capacitors. Because the two MOSFETs are integrated inside the device, they are closer to each other than in discrete solutions. PVIN and PGND pins are the connections from the MOSFETs to the input capacitors. The first step of the layout must be placing the input capacitors, especially the small value ceramic bypass one, as close as possible to PVIN and PGND pins.

The LM73605/6 pin out is optimized for low EMI layout. Multiple pins are used for PVIN and PGND to minimized bond wire resistances and inductances. The PVIN and PGND pins are right next to each other to simplify optimal layout. The CBOOT pin is placed next to SW pin for easy and compact C_{BOOT} capacitor layout.

10.1.2 Ground Plane

The ground plane of a PCB provides the best return path for the pulsing current on the device layer. Make sure the ground plane is solid, especially the part right underneath the pulsing current paths. Solid copper under a pulsing current path provide a mirrored return path for the high frequency components and minimize voltage spikes generated by the pulsing current. It shields the layers on the other side of the plane from switching noises. Route signal traces on the other side of the ground plane as much as possible. Use multiple vias in parallel to connect the grounds on the device layer to the ground plane.

10.1.3 Optimize Thermal Performance

The key to thermal optimization on PCB design is to provide heat transferring paths from the device to the outer large copper area. Use thick copper (2 oz) on high current layer(s) if possible. Use thermal vias under the DAP to transfer heat to other layers. Connect NC pins to the GND net, so that GND copper can run underneath the device to create dog-bone shape heat sink. Try to leave copper solid on IC side as much as possible above and below the device. Place components and route traces away from major heat transferring paths if possible, to avoid blocking heat dissipation path. Try to leave copper solid, free of components and traces, around the thermal vias on the other side of the board as well. Solid copper behaves as heat sink to spread the heat to a larger area and provide more contact area to the air.

When calculating power dissipation, use the maximum input voltage and the average output current for the application. Many common operating conditions are provided in [Application Curves](#). Less common applications can be derived through interpolation. In all designs, the junction temperature must be kept below the rated maximum of 125°C.

Layout Guidelines (continued)

The thermal characteristics of the LM73605/6 are specified using the parameter $R_{\theta JA}$, which characterize thermal resistance from the junction of the silicon to the ambient in a specific system. Although the value of $R_{\theta JA}$ is dependant on many variables, it still can be used to approximate the operating junction temperature of the device. To obtain an estimate of the device junction temperature, one may use [Equation 30](#):

$$T_J = P_{IC_LOSS} \times R_{\theta JA} + T_A$$

where

- T_J = Junction temperature in °C
- $P_{IC_LOSS} = V_{IN} \times I_{IN} \times (1 - \text{Efficiency}) - 1.1 \times I_{OUT} \times DCR$
- DCR = Inductor DC parasitic resistance in Ω
- $R_{\theta JA}$ = Junction-to-ambient thermal resistance of the device in °C/W
- T_A = Ambient temperature in °C. (30)

The maximum operating junction temperature of the LM73605/6 is 125°C. $R_{\theta JA}$ is highly related to PCB size and layout, as well as environmental factors such as heat sinking and air flow. [Figure 76](#) shows measured results of $R_{\theta JA}$ with different copper area on 2-layer boards and 4-layer boards, with 1-W and 2-W power dissipation on the LM73605/6.

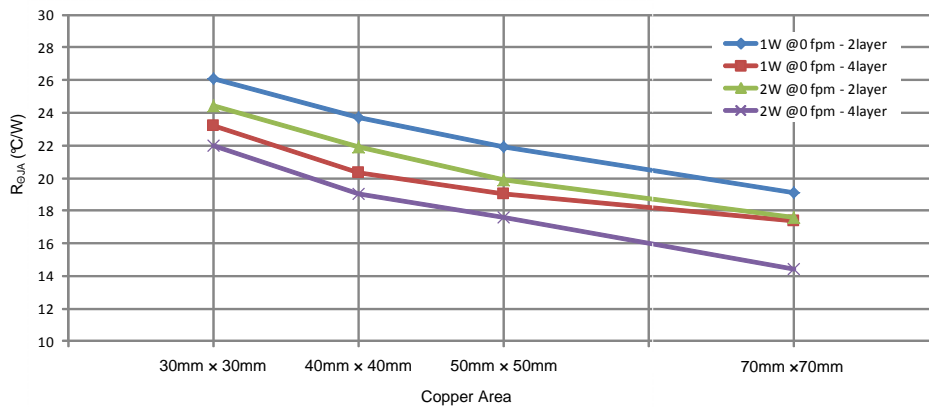

Figure 76. Measured $R_{\theta JA}$ vs PCB Copper Area on 2-Layer Boards and 4-Layer Boards

10.2 Layout Example

A layout example is shown in [Figure 77](#). A four-layer board is used with 2-oz copper on the top and bottom layers and 1-oz copper on the inner two layers. [Figure 77](#) shows the relative scale of the LM73605/6 device with 0805 and 1210 input and output capacitors, 7-mm × 7-mm inductor and 0603 case size for all other passive components. The trace width of the signal connections are not to scale.

The components are placed on the top layer and the high current paths are routed on the top layer as well. The remaining space on the top layer can be filled with GND polygon. Thermal vias are used under the DAP and around the device. The GND copper was extended to the outside of the device, which serves as copper heat sink.

The mid-layer 1 is right underneath the top layer. It is a solid ground plane, which serves as noise shielding and heat dissipation path.

The V_{OUT} sense trace is routed on the 3rd layer, which is mid-layer 2. Ground plane provided noise shielding for the sense trace. The V_{OUT} to BIAS connection is routed by a separate trace.

The bottom layer is also a solid ground copper in this example. Solid copper provides best heat sinking for the device. If components and traces need to be on the bottom layer, please leave the area around thermal vias as solid as possible. Try not to cut heat dissipation path by a trace. The board can be used for various frequencies and output voltages, with component variation. For more details, see the [LM73605/LM73606 EVM User's Guide](#).

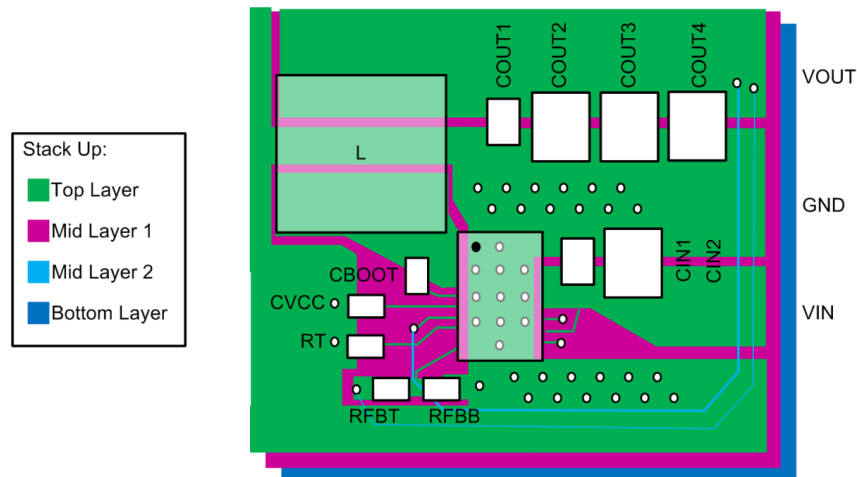

Figure 77. LM73605/6 Layout Example

11 Device and Documentation Support

11.1 Device Support

11.1.1 Third-Party Products Disclaimer

TI'S PUBLICATION OF INFORMATION REGARDING THIRD-PARTY PRODUCTS OR SERVICES DOES NOT CONSTITUTE AN ENDORSEMENT REGARDING THE SUITABILITY OF SUCH PRODUCTS OR SERVICES OR A WARRANTY, REPRESENTATION OR ENDORSEMENT OF SUCH PRODUCTS OR SERVICES, EITHER ALONE OR IN COMBINATION WITH ANY TI PRODUCT OR SERVICE.

11.1.2 Custom Design With WEBENCH® Tools

[Click here](#) to create a custom design using the [LM73605](#) or [LM73606](#) device with the WEBENCH® Power Designer.

1. Start by entering the input voltage (V_{IN}), output voltage (V_{OUT}), and output current (I_{OUT}) requirements.
2. Optimize the design for key parameters such as efficiency, footprint, and cost using the optimizer dial.
3. Compare the generated design with other possible solutions from Texas Instruments.

The WEBENCH Power Designer provides a customized schematic along with a list of materials with real-time pricing and component availability.

In most cases, these actions are available:

- Run electrical simulations to see important waveforms and circuit performance
- Run thermal simulations to understand board thermal performance
- Export customized schematic and layout into popular CAD formats
- Print PDF reports for the design, and share the design with colleagues

Get more information about WEBENCH tools at www.ti.com/WEBENCH.

11.2 Related Documentation

For related documentation see the following:

[AN-2020 Thermal Design By Insight, Not Hindsight](#)

11.3 Related Links

The table below lists quick access links. Categories include technical documents, support and community resources, tools and software, and quick access to order now.

Table 5. Related Links

PARTS	PRODUCT FOLDER	ORDER NOW	TECHNICAL DOCUMENTS	TOOLS & SOFTWARE	SUPPORT & COMMUNITY
LM73605	Click here	Click here	Click here	Click here	Click here
LM73606	Click here	Click here	Click here	Click here	Click here

11.4 Receiving Notification of Documentation Updates

To receive notification of documentation updates, navigate to the device product folder on ti.com. In the upper right corner, click on *Alert me* to register and receive a weekly digest of any product information that has changed. For change details, review the revision history included in any revised document.

11.5 Community Resources

The following links connect to TI community resources. Linked contents are provided "AS IS" by the respective contributors. They do not constitute TI specifications and do not necessarily reflect TI's views; see TI's [Terms of Use](#).

TI E2E™ Online Community *TI's Engineer-to-Engineer (E2E) Community*. Created to foster collaboration among engineers. At e2e.ti.com, you can ask questions, share knowledge, explore ideas and help solve problems with fellow engineers.

Design Support *TI's Design Support* Quickly find helpful E2E forums along with design support tools and contact information for technical support.

11.6 Trademarks

E2E is a trademark of Texas Instruments.

WEBENCH is a registered trademark of Texas Instruments.

SP-CAP is a trademark of Panasonic.

POSCAP is a trademark of Sanyo Electric Co., Ltd..

11.7 Electrostatic Discharge Caution



These devices have limited built-in ESD protection. The leads should be shorted together or the device placed in conductive foam during storage or handling to prevent electrostatic damage to the MOS gates.

11.8 Glossary

[SLYZ022](#) — *TI Glossary*.

This glossary lists and explains terms, acronyms, and definitions.

12 Mechanical, Packaging, and Orderable Information

The following pages include mechanical, packaging, and orderable information. This information is the most current data available for the designated devices. This data is subject to change without notice and revision of this document. For browser-based versions of this data sheet, refer to the left-hand navigation.

PACKAGING INFORMATION

Orderable Device	Status (1)	Package Type	Package Drawing	Pins	Package Qty	Eco Plan (2)	Lead/Ball Finish (6)	MSL Peak Temp (3)	Op Temp (°C)	Device Marking (4/5)	Samples
LM73605RNPR	ACTIVE	WQFN	RNP	30	3000	Green (RoHS & no Sb/Br)	CU SN	Level-2-260C-1 YEAR	-40 to 125	LM73605R NP	Samples
LM73605RNPT	ACTIVE	WQFN	RNP	30	250	Green (RoHS & no Sb/Br)	CU SN	Level-2-260C-1 YEAR	-40 to 125	LM73605R NP	Samples
LM73606RNPR	ACTIVE	WQFN	RNP	30	3000	Green (RoHS & no Sb/Br)	CU SN	Level-2-260C-1 YEAR	-40 to 125	LM73606R NP	Samples
LM73606RNPT	ACTIVE	WQFN	RNP	30	250	Green (RoHS & no Sb/Br)	CU SN	Level-2-260C-1 YEAR	-40 to 125	LM73606R NP	Samples

(1) The marketing status values are defined as follows:

ACTIVE: Product device recommended for new designs.

LIFEBUY: TI has announced that the device will be discontinued, and a lifetime-buy period is in effect.

NRND: Not recommended for new designs. Device is in production to support existing customers, but TI does not recommend using this part in a new design.

PREVIEW: Device has been announced but is not in production. Samples may or may not be available.

OBSELETE: TI has discontinued the production of the device.

(2) **RoHS:** TI defines "RoHS" to mean semiconductor products that are compliant with the current EU RoHS requirements for all 10 RoHS substances, including the requirement that RoHS substance do not exceed 0.1% by weight in homogeneous materials. Where designed to be soldered at high temperatures, "RoHS" products are suitable for use in specified lead-free processes. TI may reference these types of products as "Pb-Free".

RoHS Exempt: TI defines "RoHS Exempt" to mean products that contain lead but are compliant with EU RoHS pursuant to a specific EU RoHS exemption.

Green: TI defines "Green" to mean the content of Chlorine (Cl) and Bromine (Br) based flame retardants meet JS709B low halogen requirements of <=1000ppm threshold. Antimony trioxide based flame retardants must also meet the <=1000ppm threshold requirement.

(3) MSL, Peak Temp. - The Moisture Sensitivity Level rating according to the JEDEC industry standard classifications, and peak solder temperature.

(4) There may be additional marking, which relates to the logo, the lot trace code information, or the environmental category on the device.

(5) Multiple Device Markings will be inside parentheses. Only one Device Marking contained in parentheses and separated by a "-" will appear on a device. If a line is indented then it is a continuation of the previous line and the two combined represent the entire Device Marking for that device.

(6) Lead/Ball Finish - Orderable Devices may have multiple material finish options. Finish options are separated by a vertical ruled line. Lead/Ball Finish values may wrap to two lines if the finish value exceeds the maximum column width.

Important Information and Disclaimer: The information provided on this page represents TI's knowledge and belief as of the date that it is provided. TI bases its knowledge and belief on information provided by third parties, and makes no representation or warranty as to the accuracy of such information. Efforts are underway to better integrate information from third parties. TI has taken and

continues to take reasonable steps to provide representative and accurate information but may not have conducted destructive testing or chemical analysis on incoming materials and chemicals. TI and TI suppliers consider certain information to be proprietary, and thus CAS numbers and other limited information may not be available for release.

In no event shall TI's liability arising out of such information exceed the total purchase price of the TI part(s) at issue in this document sold by TI to Customer on an annual basis.

TAPE AND REEL INFORMATION

QUADRANT ASSIGNMENTS FOR PIN 1 ORIENTATION IN TAPE

*All dimensions are nominal

Device	Package Type	Package Drawing	Pins	SPQ	Reel Diameter (mm)	Reel Width W1 (mm)	A0 (mm)	B0 (mm)	K0 (mm)	P1 (mm)	W (mm)	Pin1 Quadrant
LM73605RNPR	WQFN	RNP	30	3000	330.0	16.4	4.25	6.25	0.95	8.0	16.0	Q1
LM73605RNPT	WQFN	RNP	30	250	180.0	16.4	4.25	6.25	0.95	8.0	16.0	Q1
LM73606RNPR	WQFN	RNP	30	3000	330.0	16.4	4.25	6.25	0.95	8.0	16.0	Q1
LM73606RNPT	WQFN	RNP	30	250	180.0	16.4	4.25	6.25	0.95	8.0	16.0	Q1

TAPE AND REEL BOX DIMENSIONS



*All dimensions are nominal

Device	Package Type	Package Drawing	Pins	SPQ	Length (mm)	Width (mm)	Height (mm)
LM73605RNPR	WQFN	RNP	30	3000	370.0	355.0	55.0
LM73605RNPT	WQFN	RNP	30	250	195.0	200.0	45.0
LM73606RNPR	WQFN	RNP	30	3000	370.0	355.0	55.0
LM73606RNPT	WQFN	RNP	30	250	195.0	200.0	45.0

RNP0030A

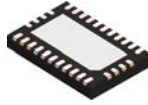

PACKAGE OUTLINE

WQFN - 0.8 mm max height

PLASTIC QUAD FLATPACK - NO LEAD

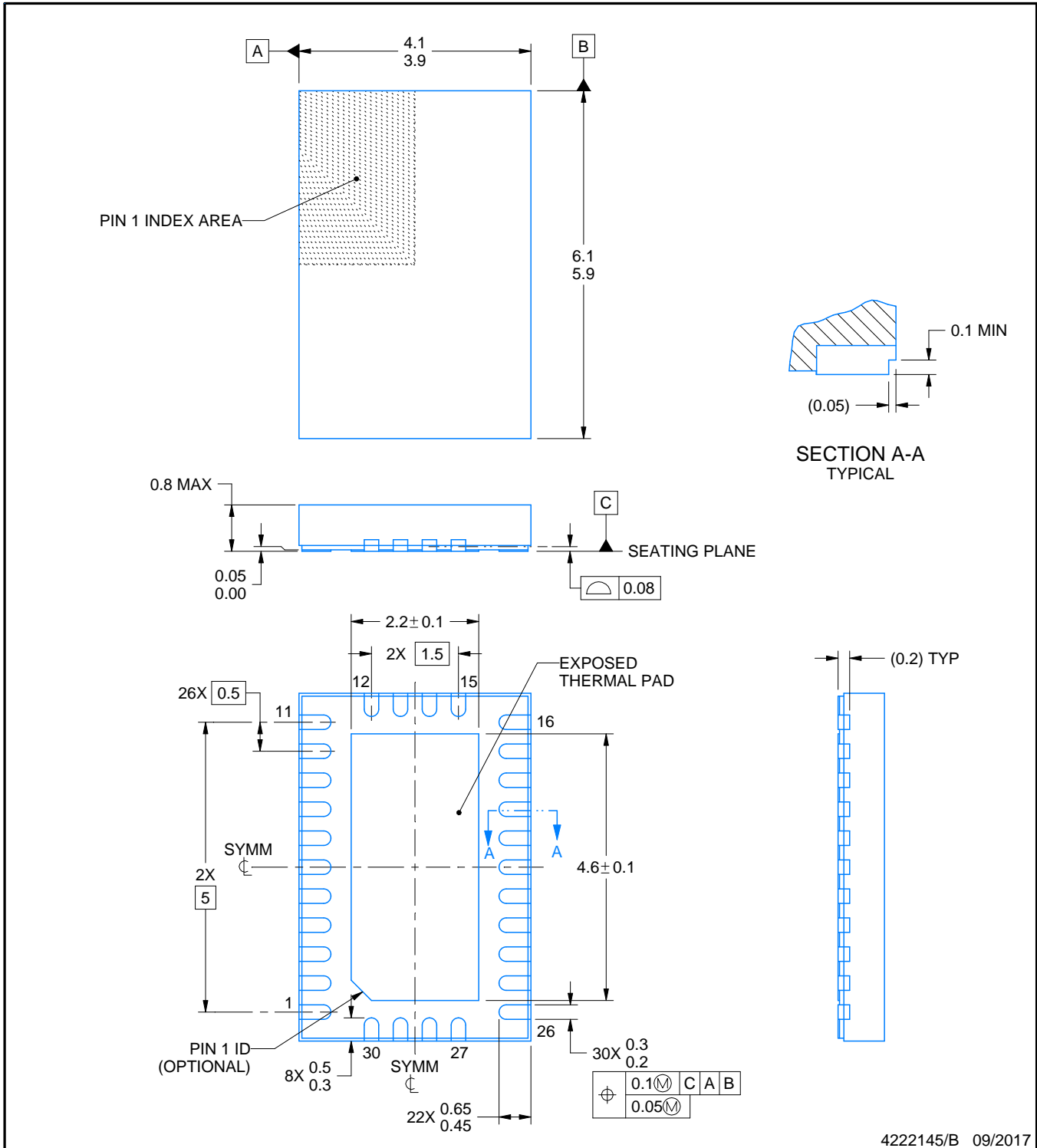

4222145/B 09/2017

NOTES:

1. All linear dimensions are in millimeters. Any dimensions in parenthesis are for reference only. Dimensioning and tolerancing per ASME Y14.5M.
2. This drawing is subject to change without notice.
3. The package thermal pad must be soldered to the printed circuit board for thermal and mechanical performance.

EXAMPLE BOARD LAYOUT

RNP0030A

WQFN - 0.8 mm max height

PLASTIC QUAD FLATPACK - NO LEAD

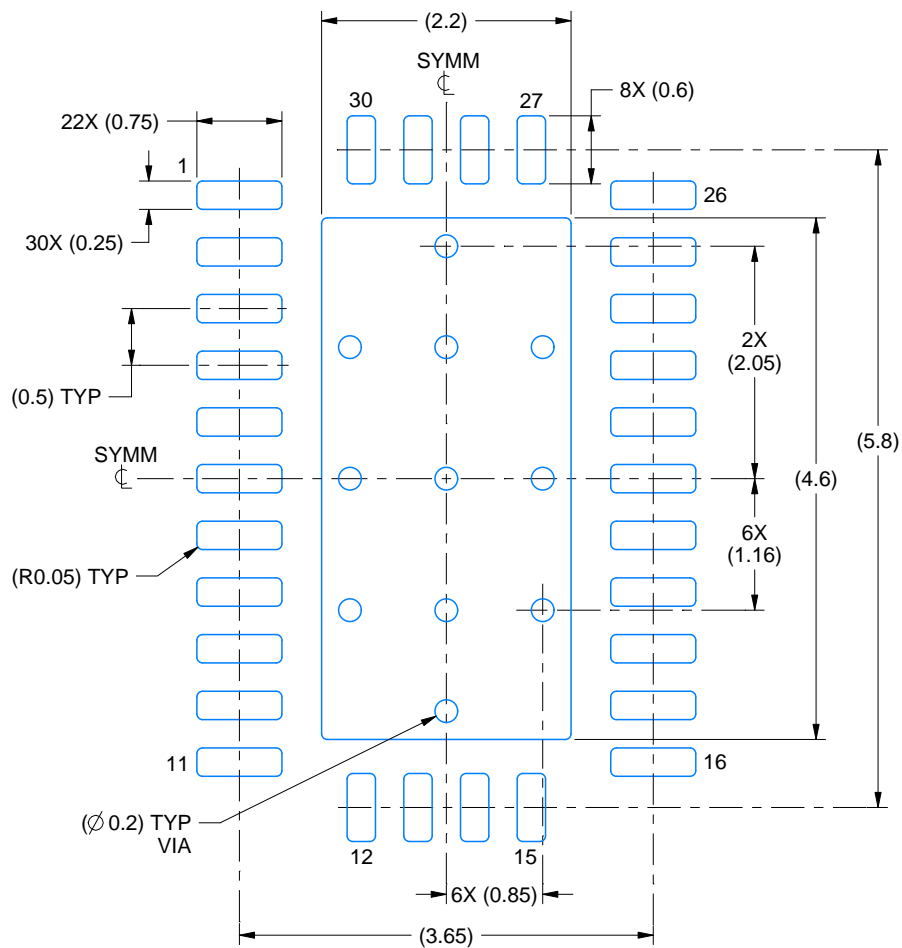

LAND PATTERN EXAMPLE
SCALE:15X

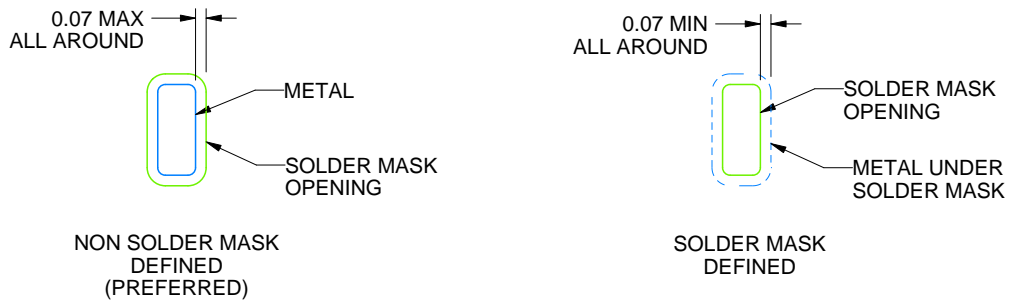

SOLDER MASK DETAILS

4222145/B 09/2017

NOTES: (continued)

4. This package is designed to be soldered to a thermal pad on the board. For more information, see Texas Instruments literature number SLUA271 (www.ti.com/lit/slua271).

EXAMPLE STENCIL DESIGN

RNP0030A

WQFN - 0.8 mm max height

PLASTIC QUAD FLATPACK - NO LEAD

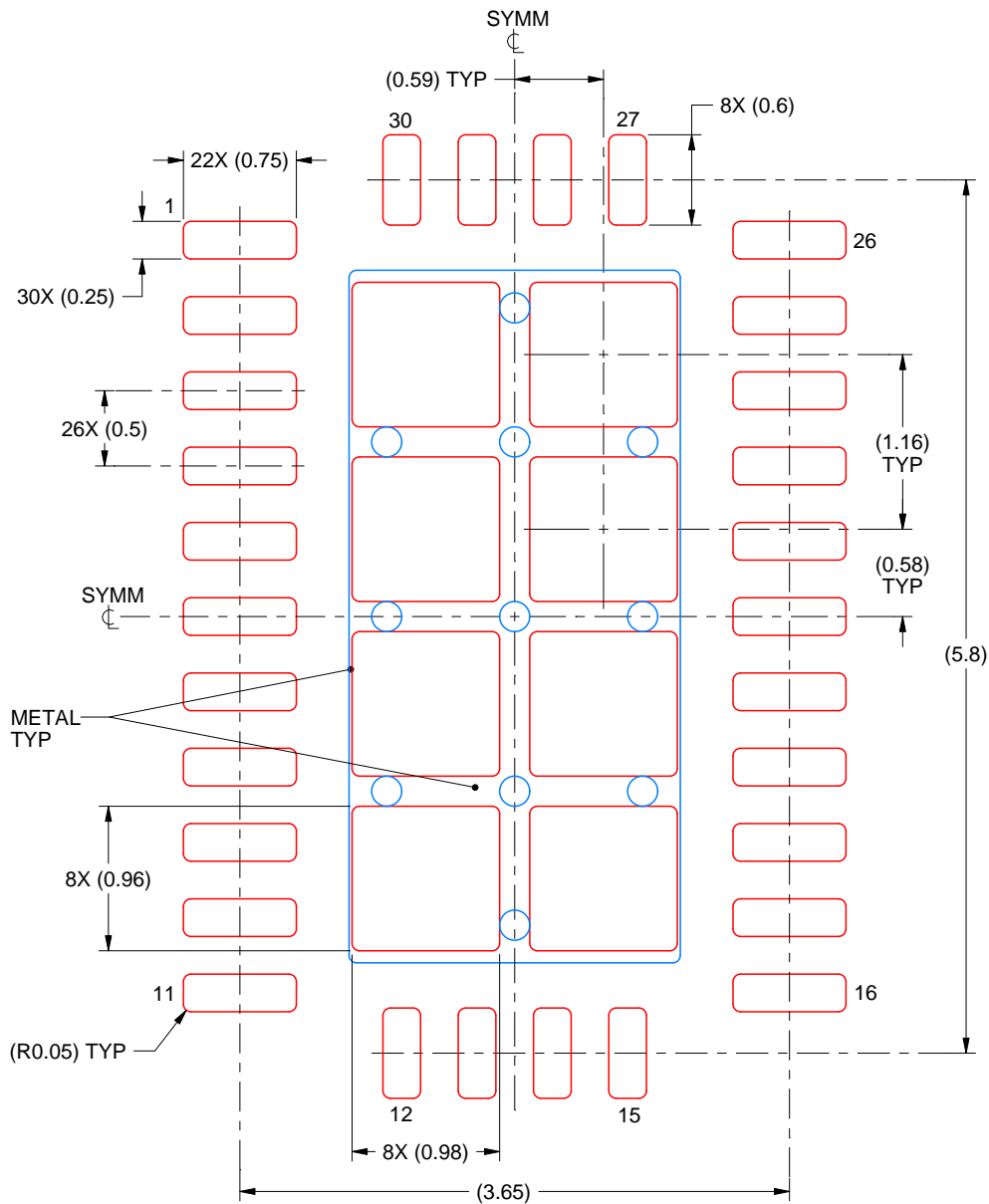

SOLDER PASTE EXAMPLE
 BASED ON 0.125 mm THICK STENCIL

EXPOSED PAD
 74.4% PRINTED SOLDER COVERAGE BY AREA
 SCALE:20X

4222145/B 09/2017

NOTES: (continued)

5. Laser cutting apertures with trapezoidal walls and rounded corners may offer better paste release. IPC-7525 may have alternate design recommendations.

IMPORTANT NOTICE

Texas Instruments Incorporated (TI) reserves the right to make corrections, enhancements, improvements and other changes to its semiconductor products and services per JESD46, latest issue, and to discontinue any product or service per JESD48, latest issue. Buyers should obtain the latest relevant information before placing orders and should verify that such information is current and complete.

TI's published terms of sale for semiconductor products (<http://www.ti.com/sc/docs/stdterms.htm>) apply to the sale of packaged integrated circuit products that TI has qualified and released to market. Additional terms may apply to the use or sale of other types of TI products and services.

Reproduction of significant portions of TI information in TI data sheets is permissible only if reproduction is without alteration and is accompanied by all associated warranties, conditions, limitations, and notices. TI is not responsible or liable for such reproduced documentation. Information of third parties may be subject to additional restrictions. Resale of TI products or services with statements different from or beyond the parameters stated by TI for that product or service voids all express and any implied warranties for the associated TI product or service and is an unfair and deceptive business practice. TI is not responsible or liable for any such statements.

Buyers and others who are developing systems that incorporate TI products (collectively, "Designers") understand and agree that Designers remain responsible for using their independent analysis, evaluation and judgment in designing their applications and that Designers have full and exclusive responsibility to assure the safety of Designers' applications and compliance of their applications (and of all TI products used in or for Designers' applications) with all applicable regulations, laws and other applicable requirements. Designer represents that, with respect to their applications, Designer has all the necessary expertise to create and implement safeguards that (1) anticipate dangerous consequences of failures, (2) monitor failures and their consequences, and (3) lessen the likelihood of failures that might cause harm and take appropriate actions. Designer agrees that prior to using or distributing any applications that include TI products, Designer will thoroughly test such applications and the functionality of such TI products as used in such applications.

TI's provision of technical, application or other design advice, quality characterization, reliability data or other services or information, including, but not limited to, reference designs and materials relating to evaluation modules, (collectively, "TI Resources") are intended to assist designers who are developing applications that incorporate TI products; by downloading, accessing or using TI Resources in any way, Designer (individually or, if Designer is acting on behalf of a company, Designer's company) agrees to use any particular TI Resource solely for this purpose and subject to the terms of this Notice.

TI's provision of TI Resources does not expand or otherwise alter TI's applicable published warranties or warranty disclaimers for TI products, and no additional obligations or liabilities arise from TI providing such TI Resources. TI reserves the right to make corrections, enhancements, improvements and other changes to its TI Resources. TI has not conducted any testing other than that specifically described in the published documentation for a particular TI Resource.

Designer is authorized to use, copy and modify any individual TI Resource only in connection with the development of applications that include the TI product(s) identified in such TI Resource. NO OTHER LICENSE, EXPRESS OR IMPLIED, BY ESTOPPEL OR OTHERWISE TO ANY OTHER TI INTELLECTUAL PROPERTY RIGHT, AND NO LICENSE TO ANY TECHNOLOGY OR INTELLECTUAL PROPERTY RIGHT OF TI OR ANY THIRD PARTY IS GRANTED HEREIN, including but not limited to any patent right, copyright, mask work right, or other intellectual property right relating to any combination, machine, or process in which TI products or services are used. Information regarding or referencing third-party products or services does not constitute a license to use such products or services, or a warranty or endorsement thereof. Use of TI Resources may require a license from a third party under the patents or other intellectual property of the third party, or a license from TI under the patents or other intellectual property of TI.

TI RESOURCES ARE PROVIDED "AS IS" AND WITH ALL FAULTS. TI DISCLAIMS ALL OTHER WARRANTIES OR REPRESENTATIONS, EXPRESS OR IMPLIED, REGARDING RESOURCES OR USE THEREOF, INCLUDING BUT NOT LIMITED TO ACCURACY OR COMPLETENESS, TITLE, ANY EPIDEMIC FAILURE WARRANTY AND ANY IMPLIED WARRANTIES OF MERCHANTABILITY, FITNESS FOR A PARTICULAR PURPOSE, AND NON-INFRINGEMENT OF ANY THIRD PARTY INTELLECTUAL PROPERTY RIGHTS. TI SHALL NOT BE LIABLE FOR AND SHALL NOT DEFEND OR INDEMNIFY DESIGNER AGAINST ANY CLAIM, INCLUDING BUT NOT LIMITED TO ANY INFRINGEMENT CLAIM THAT RELATES TO OR IS BASED ON ANY COMBINATION OF PRODUCTS EVEN IF DESCRIBED IN TI RESOURCES OR OTHERWISE. IN NO EVENT SHALL TI BE LIABLE FOR ANY ACTUAL, DIRECT, SPECIAL, COLLATERAL, INDIRECT, PUNITIVE, INCIDENTAL, CONSEQUENTIAL OR EXEMPLARY DAMAGES IN CONNECTION WITH OR ARISING OUT OF TI RESOURCES OR USE THEREOF, AND REGARDLESS OF WHETHER TI HAS BEEN ADVISED OF THE POSSIBILITY OF SUCH DAMAGES.

Unless TI has explicitly designated an individual product as meeting the requirements of a particular industry standard (e.g., ISO/TS 16949 and ISO 26262), TI is not responsible for any failure to meet such industry standard requirements.

Where TI specifically promotes products as facilitating functional safety or as compliant with industry functional safety standards, such products are intended to help enable customers to design and create their own applications that meet applicable functional safety standards and requirements. Using products in an application does not by itself establish any safety features in the application. Designers must ensure compliance with safety-related requirements and standards applicable to their applications. Designer may not use any TI products in life-critical medical equipment unless authorized officers of the parties have executed a special contract specifically governing such use. Life-critical medical equipment is medical equipment where failure of such equipment would cause serious bodily injury or death (e.g., life support, pacemakers, defibrillators, heart pumps, neurostimulators, and implantables). Such equipment includes, without limitation, all medical devices identified by the U.S. Food and Drug Administration as Class III devices and equivalent classifications outside the U.S.

TI may expressly designate certain products as completing a particular qualification (e.g., Q100, Military Grade, or Enhanced Product). Designers agree that it has the necessary expertise to select the product with the appropriate qualification designation for their applications and that proper product selection is at Designers' own risk. Designers are solely responsible for compliance with all legal and regulatory requirements in connection with such selection.

Designer will fully indemnify TI and its representatives against any damages, costs, losses, and/or liabilities arising out of Designer's non-compliance with the terms and provisions of this Notice.