

LM2990 Negative Low Dropout Regulator

Check for Samples: [LM2990](#)

FEATURES

- 5% Output Accuracy over Entire Operating Range
- Output Current in Excess of 1A
- Dropout Voltage Typically 0.6V at 1A Load
- Low Quiescent Current
- Internal Short Circuit Current Limit
- Internal Thermal Shutdown with Hysteresis
- Functional Complement to the LM2940 Series

APPLICATIONS

- Post Switcher Regulator
- Local, On-Card, Regulation
- Battery Operated Equipment

DESCRIPTION

The LM2990 is a three-terminal, low dropout, 1 ampere negative voltage regulator available with fixed output voltages of -5, -5.2, -12, and -15V.

The LM2990 uses new circuit design techniques to provide low dropout and low quiescent current. The dropout voltage at 1A load current is typically 0.6V and an ensured worst-case maximum of 1V over the entire operating temperature range. The quiescent current is typically 1 mA with 1A load current and an input-output voltage differential greater than 3V. A unique circuit design of the internal bias supply limits the quiescent current to only 9 mA (typical) when the regulator is in the dropout mode ($V_{OUT} - V_{IN} \leq 3V$). Output voltage accuracy is ensured to $\pm 5\%$ over load, and temperature extremes.

The LM2990 is short-circuit proof, and thermal shutdown includes hysteresis to enhance the reliability of the device when overloaded for an extended period of time. The LM2990 is available in a 3-lead package and is rated for operation over the automotive temperature range of -40°C to $+125^{\circ}\text{C}$.

Typical Application

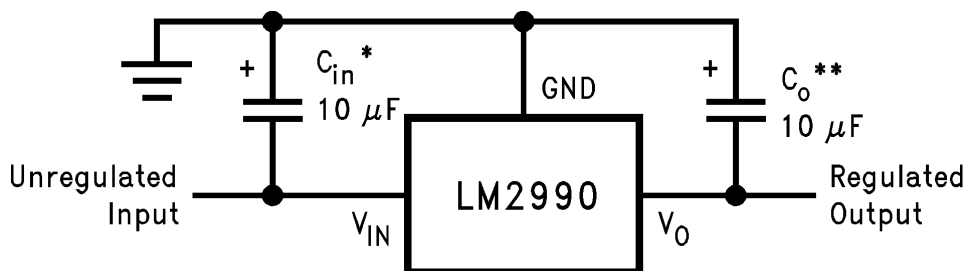

*Required if the regulator is located further than 6 inches from the power supply filter capacitors. A 1 μF solid tantalum or a 10 μF aluminum electrolytic capacitor is recommended.

**Required for stability. Must be at least a 10 μF aluminum electrolytic or a 1 μF solid tantalum to maintain stability. May be increased without bound to maintain regulation during transients. Locate the capacitor as close as possible to the regulator. The equivalent series resistance (ESR) is critical, and should be less than 10 Ω over the same operating temperature range as the regulator.



Please be aware that an important notice concerning availability, standard warranty, and use in critical applications of Texas Instruments semiconductor products and disclaimers thereto appears at the end of this data sheet.

All trademarks are the property of their respective owners.

Connection Diagrams

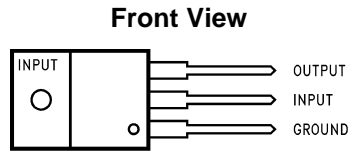

Figure 1. 3-Lead TO-220 Package
See Package Number NDE0003B

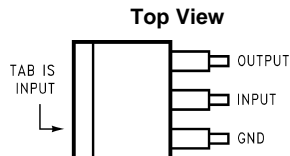

Figure 2. Surface-Mount DPAK/TO-263 Package
See Package Number KTT0003B

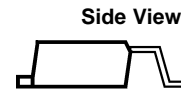

Figure 3. Surface-Mount DPAK/TO-263 Package
See Package Number KTT0003B

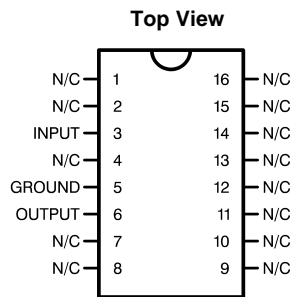

Figure 4. 16-Lead CDIP Package
See Package Number NFE0016A

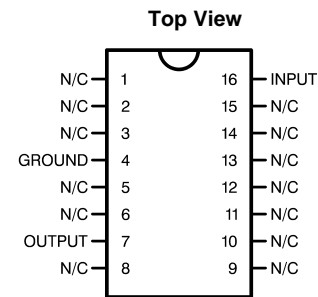

Figure 5. 16-Lead CLGA Package
See Package Number NAC0016A



These devices have limited built-in ESD protection. The leads should be shorted together or the device placed in conductive foam during storage or handling to prevent electrostatic damage to the MOS gates.

Absolute Maximum Ratings⁽¹⁾⁽²⁾

Input Voltage		-26V to +0.3V
ESD Susceptibility ⁽³⁾		2 kV
Power Dissipation ⁽⁴⁾		Internally Limited
Junction Temperature (T _{Jmax})		125°C
Storage Temperature		-65°C to +150°C
Soldering Temperature	TO-220 (T), Wave	260°C, 10 sec
	DDPAK/TO-263 (S)	235°C, 30 sec

- (1) Absolute Maximum Ratings indicate limits beyond which damage to the device may occur. Operating Ratings indicate conditions for which the device is intended to be functional, but do not ensure specific performance limits. For ensured specifications and test conditions, see the Electrical Characteristics.
- (2) If Military/Aerospace specified devices are required, please contact the Texas Instruments Sales Office/Distributors for availability and specifications.
- (3) Human body model, 100 pF discharged through a 1.5 kΩ resistor.
- (4) The maximum power dissipation is a function of T_{Jmax}, θ_{JA}, and T_A. The maximum allowable power dissipation at any ambient temperature is P_D = (T_{Jmax} - T_A)/θ_{JA}. If this dissipation is exceeded, the die temperature will rise above 125°C, and the LM2990 will eventually go into thermal shutdown at a T_J of approximately 160°C. For the LM2990, the junction-to-ambient thermal resistance, is 53°C/W, 73°C/W for the DDPAK/TO-263, and the junction-to-case thermal resistance is 3°C. If the DD[AK/TO-263 package is used, the thermal resistance can be reduced by increasing the P.C. board copper area thermally connected to the package. Using 0.5 square inches of copper area, θ_{JA} is 50°C/W; with 1 square inch of copper area, θ_{JA} is 37°C/W; and with 1.6 or more square inches of copper area, θ_{JA} is 32°C/W.

Operating Ratings⁽¹⁾

Junction Temperature Range (T _J)	-40°C to +125°C
Maximum Input Voltage (Operational)	-26V

- (1) Absolute Maximum Ratings indicate limits beyond which damage to the device may occur. Operating Ratings indicate conditions for which the device is intended to be functional, but do not ensure specific performance limits. For ensured specifications and test conditions, see the Electrical Characteristics.

Electrical Characteristics

V_{IN} = -5V + V_{O(NOM)}⁽¹⁾, I_O = 1A, C_O = 47 μF, unless otherwise specified. **Boldface** limits apply over the entire operating temperature range, -40°C ≤ T_J ≤ 125°C, all other limits apply for T_J = 25°C.

Parameter	Conditions	LM2990-5.0		LM2990-5.2		Units (Limit)
		Typ ⁽²⁾	Limit ⁽³⁾	Typ ⁽²⁾	Limit ⁽³⁾	
Output Voltage (V _O)	5 mA ≤ I _O ≤ 1A		-4.90 -5.10		-5.10 -5.30	V (max) mV (min)
	5 mA ≤ I _O ≤ 1A	-5	-4.75 -5.25	-5.2	-4.94 -5.46	V V (max) V (min)
Line Regulation	I _O = 5 mA, V _{O(NOM)} -1V > V _{IN} > -26V	4	40	4	40	mV (max)
Load Regulation	50 mA ≤ I _O ≤ 1A	1	40	1	40	mV (max)
Dropout Voltage	I _O = 0.1A, ΔV _O ≤ 100 mV	0.1	0.3	0.1	0.3	V (max)
	I _O = 1A, ΔV _O ≤ 100 mV	0.6	1	0.6	1	V (max)
Quiescent Current (I _q)	I _O ≤ 1A	1	5	1	5	mA (max)
	I _O = 1A, V _{IN} = V _{O(NOM)}	9	50	9	50	mA (max)
Short Circuit Current	R _L = 1Ω ⁽⁴⁾	1.8	1.5	1.8	1.5	A (min)
Maximum Output Current	See ⁽⁴⁾	1.8	1.5	1.8	1.5	A (min)
Ripple Rejection	V _{ripple} = 1 V _{rms} , f _{ripple} = 1 kHz, I _O = 5 mA	58	50	58	50	dB (min)
Output Noise Voltage	10 Hz–100 kHz, I _O = 5 mA	250	750	250	750	μV (max)
Long Term Stability	1000 Hours	2000		2000		ppm

- (1) V_{O(NOM)} is the nominal (typical) regulator output voltage, -5V, -5.2V, -12V or -15V.
 (2) Typical values are at T_J = 25°C and represent the most likely parametric norm.
 (3) Limits are specified and 100% production tested.
 (4) The short circuit current is less than the maximum output current with the -12V and -15V versions due to internal foldback current limiting. The -5V and -5.2V versions, tested with a lower input voltage, does not reach the foldback current limit and therefore conducts a higher short circuit current level. If the LM2990 output is pulled above ground, the maximum allowed current sunk back into the LM2990 is 1.5A.

Electrical Characteristics

$V_{IN} = -5V + V_{O(NOM)}^{(1)}$, $I_O = 1A$, $C_O = 47 \mu F$, unless otherwise specified. **Boldface** limits apply over the entire operating temperature range, $-40^\circ C \leq T_J \leq 125^\circ C$, all other limits apply for $T_J = 25^\circ C$.

Parameter	Conditions	LM2990-12		LM2990-15		Units (Limit)
		Typ ⁽²⁾	Limit ⁽³⁾	Typ ⁽²⁾	Limit ⁽³⁾	
Output Voltage (V_O)	$5 mA \leq I_O \leq 1A$	-12	-11.76 -12.24	-15	-14.70 -15.30	V (max) V (min) V
	$5 mA \leq I_O \leq 1A$		-11.40 -12.60		-14.25 -15.75	V (max) V (min)
Line Regulation	$I_O = 5 mA$, $V_{O(NOM)} -1V > V_{IN} > -26V$	6	60	6	60	mV (max)
Load Regulation	$50 mA \leq I_O \leq 1A$	3	50	3	50	mV (max)
Dropout Voltage	$I_O = 0.1A$, $\Delta V_O \leq 100 mV$	0.1	0.3	0.1	0.3	V (max)
	$I_O = 1A$, $\Delta V_O \leq 100 mV$	0.6	1	0.6	1	V (max)
Quiescent Current (I_q)	$I_O \leq 1A$	1	5	1	5	mA (max)
	$I_O = 1A$, $V_{IN} = V_{O(NOM)}$	9	50	9	50	mA (max)
Short Circuit Current	$R_L = 1\Omega^{(4)}$	1.2	0.9	1.0	0.75	A (min)
Maximum Output Current	See ⁽⁴⁾	1.8	1.4	1.8	1.4	A (min)
Ripple Rejection	$V_{ripple} = 1 V_{rms}$, $f_{ripple} = 1 kHz$, $I_O = 5 mA$	52	42	52	42	dB (min)
Output Noise Voltage	10 Hz–100 kHz, $I_O = 5 mA$	500	1500	600	1800	μV (max)
Long Term Stability	1000 Hours	2000		2000		ppm

(1) $V_{O(NOM)}$ is the nominal (typical) regulator output voltage, -5V, -5.2V, -12V or -15V.

(2) Typicals are at $T_J = 25^\circ C$ and represent the most likely parametric norm.

(3) Limits are specified and 100% production tested.

(4) The short circuit current is less than the maximum output current with the -12V and -15V versions due to internal foldback current limiting. The -5V and -5.2V versions, tested with a lower input voltage, does not reach the foldback current limit and therefore conducts a higher short circuit current level. If the LM2990 output is pulled above ground, the maximum allowed current sunk back into the LM2990 is 1.5A.

Definition of Terms

Dropout Voltage: The input-output voltage differential at which the circuit ceases to regulate against further reduction in input voltage. Measured when the output voltage has dropped 100 mV from the nominal value obtained at ($V_O + 5V$) input, dropout voltage is dependent upon load current and junction temperature.

Input Voltage: The DC voltage applied to the input terminals with respect to ground.

Input-Output Differential: The voltage difference between the unregulated input voltage and the regulated output voltage for which the regulator will operate.

Line Regulation: The change in output voltage for a change in the input voltage. The measurement is made under conditions of low dissipation or by using pulse techniques such that the average chip temperature is not significantly affected.

Load Regulation: The change in output voltage for a change in load current at constant chip temperature.

Long Term Stability: Output voltage stability under accelerated life-test conditions after 1000 hours with maximum rated voltage and junction temperature.

Output Noise Voltage: The rms AC voltage at the output, with constant load and no input ripple, measured over a specified frequency range.

Quiescent Current: That part of the positive input current that does not contribute to the positive load current. The regulator ground lead current.

Ripple Rejection: The ratio of the peak-to-peak input ripple voltage to the peak-to-peak output ripple voltage.

Temperature Stability of V_O : The percentage change in output voltage for a thermal variation from room temperature to either temperature extreme.

Typical Performance Characteristics

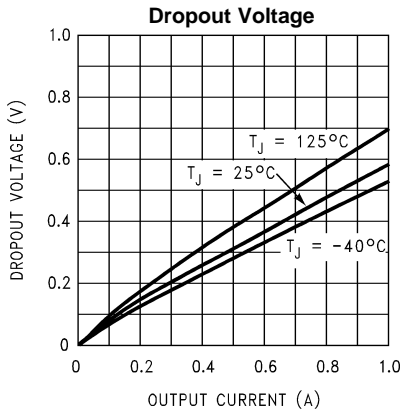

Figure 6.

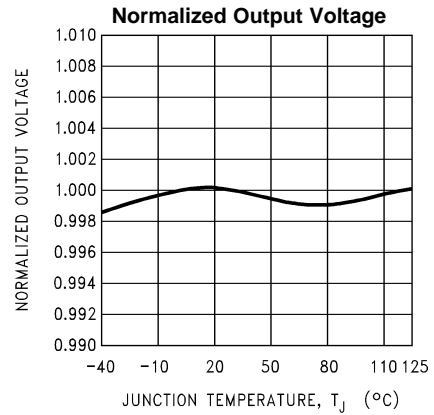

Figure 7.

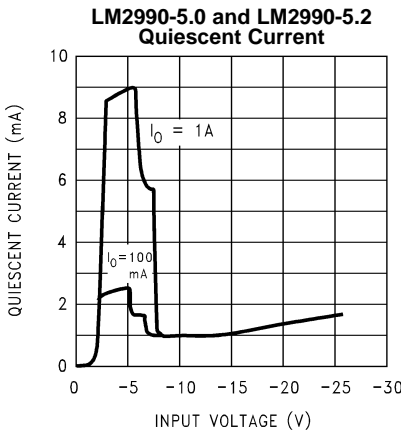

Figure 8.

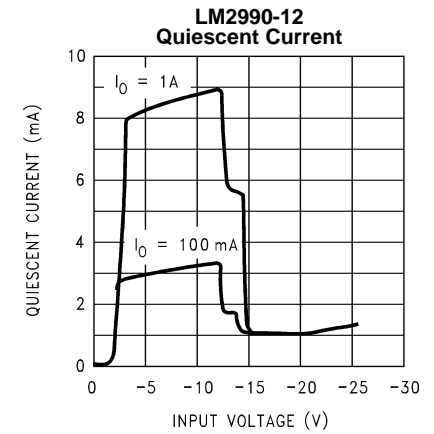

Figure 9.

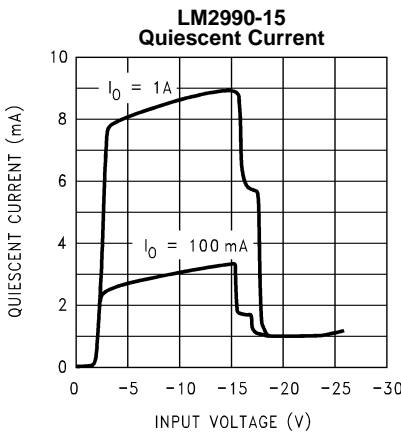

Figure 10.

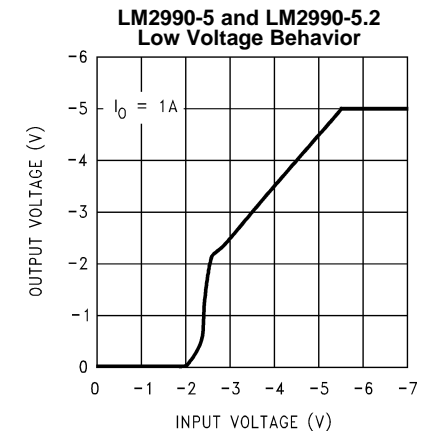

Figure 11.

Typical Performance Characteristics (continued)

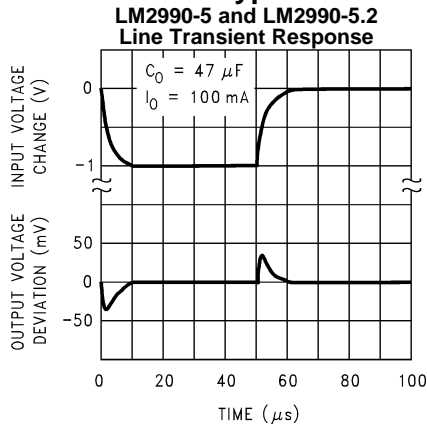

Figure 12.

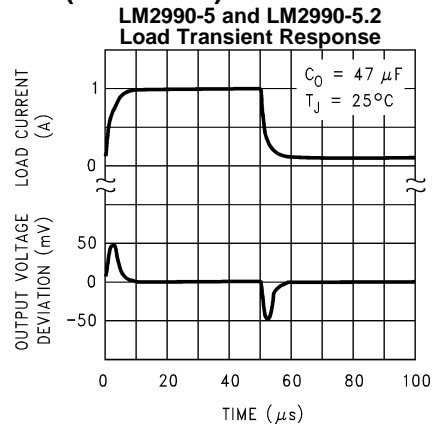

Figure 13.

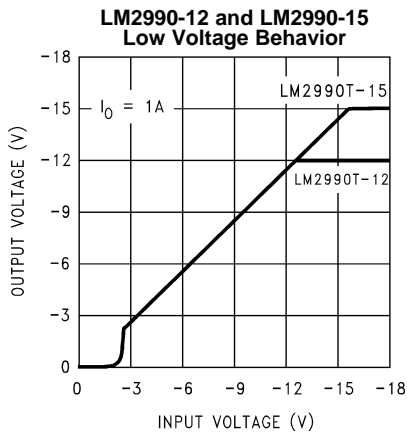

Figure 14.

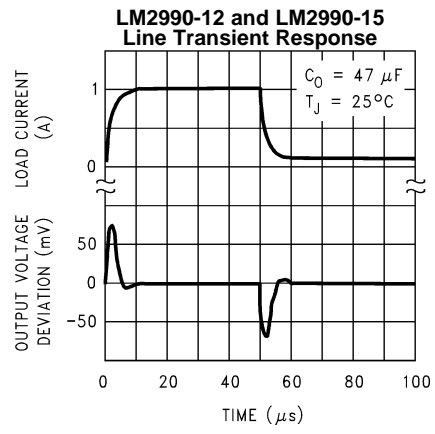

Figure 15.

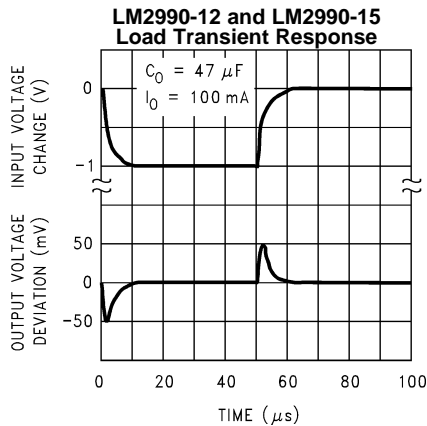

Figure 16.

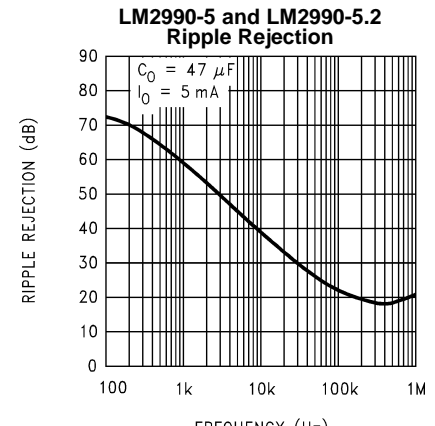

Figure 17.

Typical Performance Characteristics (continued)

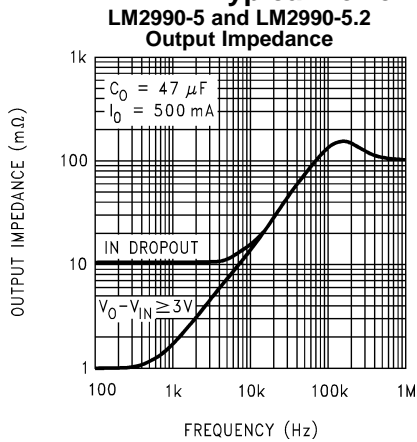

Figure 18.

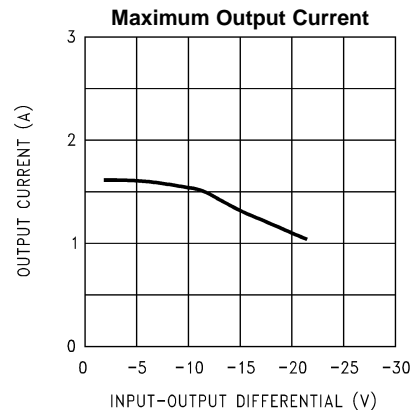

Figure 19.

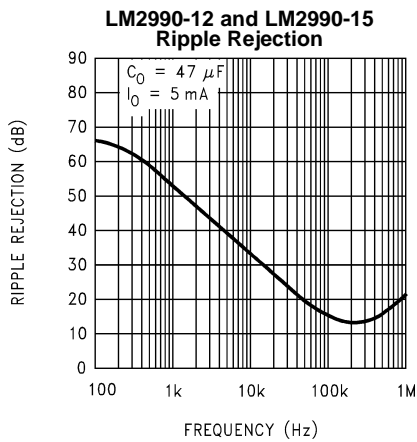

Figure 20.

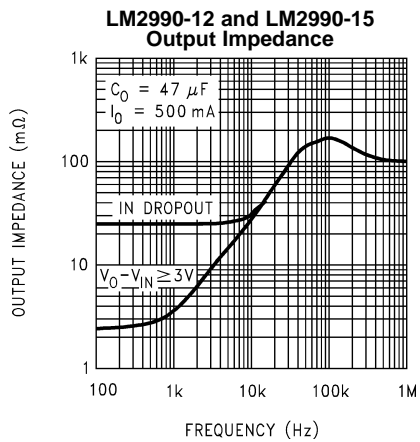

Figure 21.

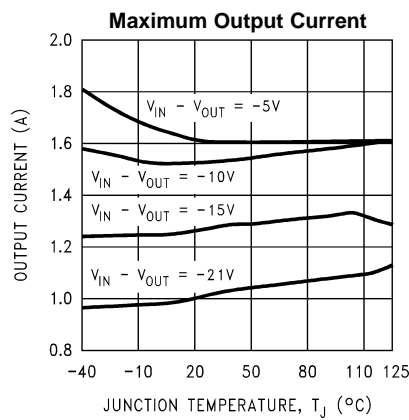

Figure 22.

Typical Performance Characteristics (continued)

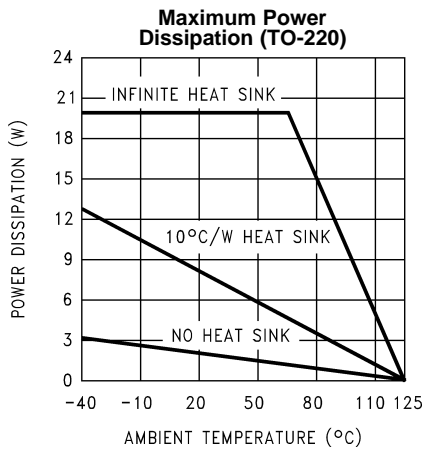

Figure 23.

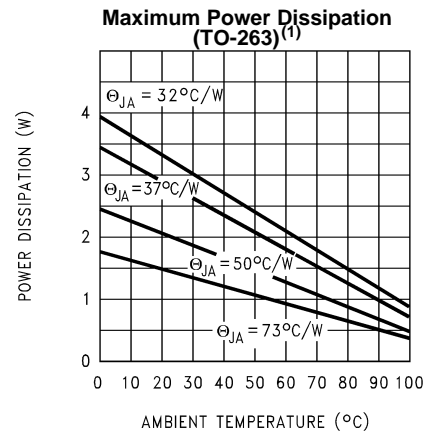

Figure 24.

- (1) The maximum power dissipation is a function of T_{Jmax} , θ_{JA} , and T_A . The maximum allowable power dissipation at any ambient temperature is $P_D = (T_{Jmax} - T_A)/\theta_{JA}$. If this dissipation is exceeded, the die temperature will rise above 125°C, and the LM2990 will eventually go into thermal shutdown at a T_J of approximately 160°C. For the LM2990, the junction-to-ambient thermal resistance, is 53°C/W, 73°C/W for the DDPAK/TO-263, and the junction-to-case thermal resistance is 3°C. If the DDPAK/TO-263 package is used, the thermal resistance can be reduced by increasing the P.C. board copper area thermally connected to the package. Using 0.5 square inches of copper area, θ_{JA} is 50°C/W; with 1 square inch of copper area, θ_{JA} is 37°C/W; and with 1.6 or more square inches of copper area, θ_{JA} is 32°C/W.

Typical Applications

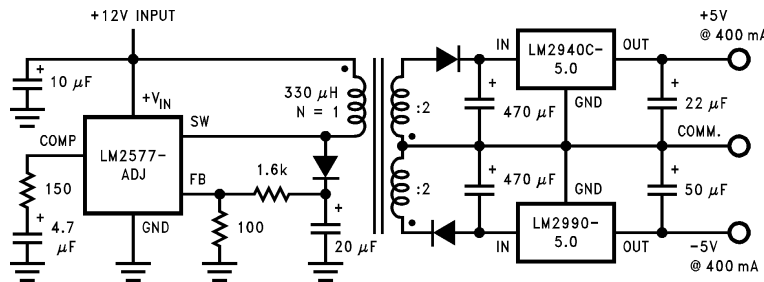

Figure 25. Post Regulator for an Isolated Switching Power Supply

The LM2940 is a positive 1A low dropout regulator; refer to its datasheet for further information.

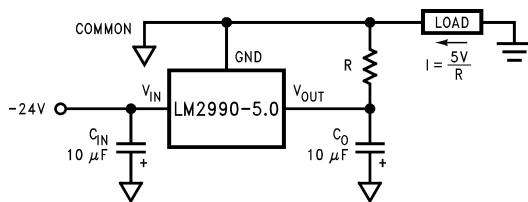

Figure 26. Fixed Current Sink

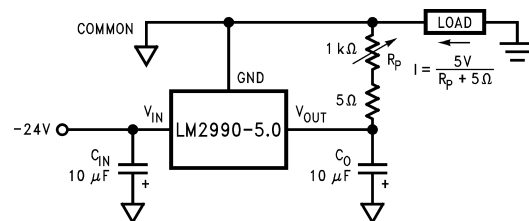

Figure 27. Adjustable Current Sink

APPLICATION HINTS

EXTERNAL CAPACITORS

The LM2990 regulator requires an output capacitor to maintain stability. The capacitor must be at least 10 μF aluminum electrolytic or 1 μF solid tantalum. The output capacitor's ESR must be less than 10Ω , or the zero added to the regulator frequency response by the ESR could reduce the phase margin, creating oscillations (refer to the graph on the right). An input capacitor, of at least 1 μF solid tantalum or 10 μF aluminum electrolytic, is also needed if the regulator is situated more than 6" from the input power supply filter.

FORCING THE OUTPUT POSITIVE

Due to an internal clamp circuit, the LM2990 can withstand positive voltages on its output. If the voltage source pulling the output positive is DC, the current must be limited to 1.5A. A current over 1.5A fed back into the LM2990 could damage the device. The LM2990 output can also withstand fast positive voltage transients up to 26V, without any current limiting of the source. However, if the transients have a duration of over 1 ms, the output should be clamped with a Schottky diode to ground.

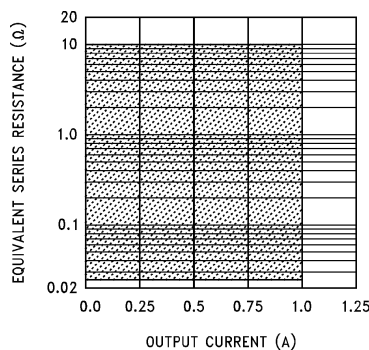
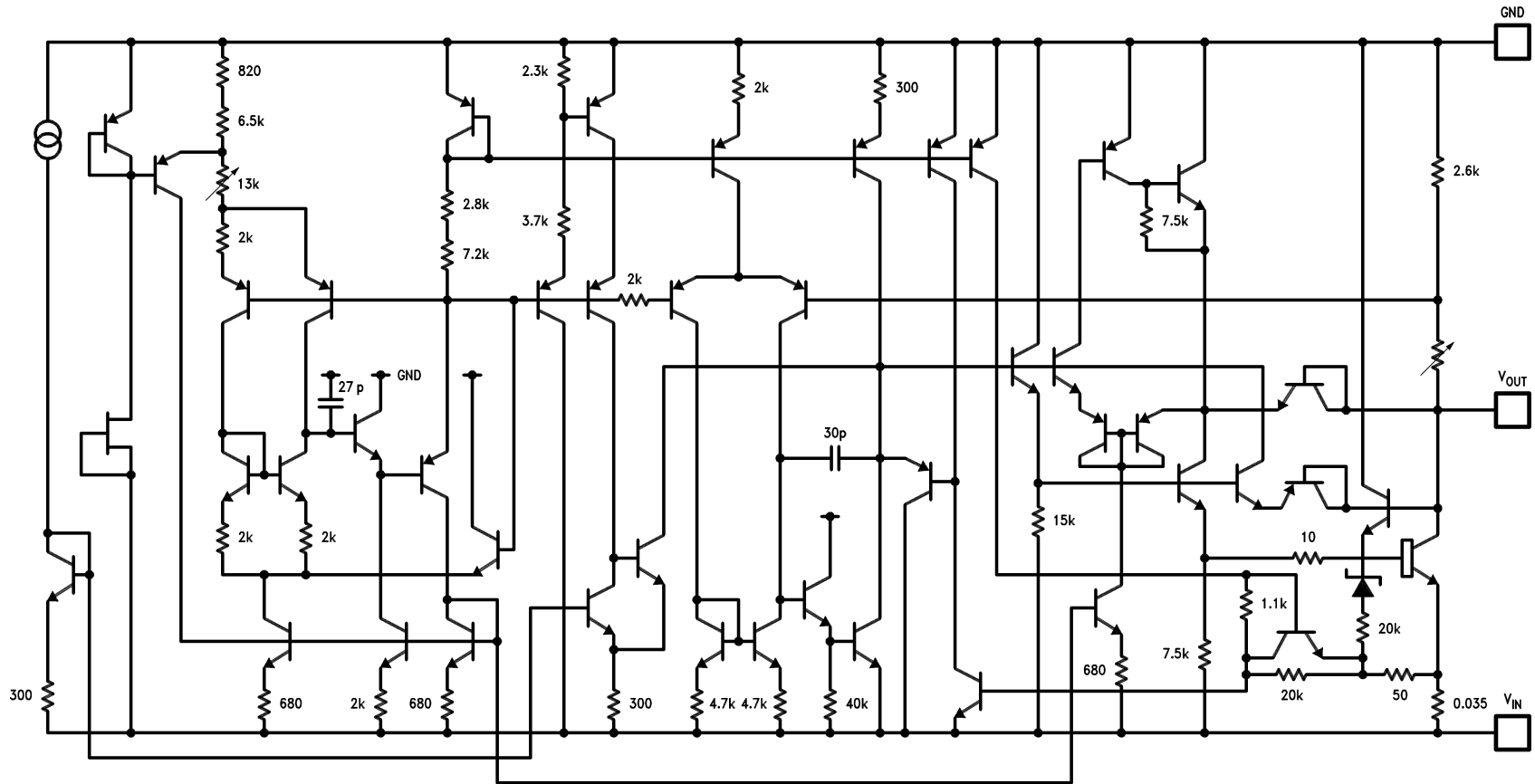

Figure 28. Output Capacitor ESR

Equivalent Schematic





REVISION HISTORY

Changes from Revision C (April 2013) to Revision D	Page
• Changed layout of National Data Sheet to TI format	11

PACKAGING INFORMATION

Orderable Device	Status (1)	Package Type	Package Drawing	Pins	Package Qty	Eco Plan (2)	Lead/Ball Finish (6)	MSL Peak Temp (3)	Op Temp (°C)	Device Marking (4/5)	Samples
LM2990S-12	NRND	DDPAK/ TO-263	KTT	3	45	TBD	Call TI	Call TI	-40 to 125	LM2990S -12 P+	
LM2990S-12/NOPB	ACTIVE	DDPAK/ TO-263	KTT	3	45	Pb-Free (RoHS Exempt)	CU SN	Level-3-245C-168 HR	-40 to 125	LM2990S -12 P+	Samples
LM2990S-15	NRND	DDPAK/ TO-263	KTT	3	45	TBD	Call TI	Call TI	-40 to 125	LM2990S -15 P+	
LM2990S-15/NOPB	ACTIVE	DDPAK/ TO-263	KTT	3	45	Pb-Free (RoHS Exempt)	CU SN	Level-3-245C-168 HR	-40 to 125	LM2990S -15 P+	Samples
LM2990S-5.0	NRND	DDPAK/ TO-263	KTT	3	45	TBD	Call TI	Call TI	-40 to 125	LM2990S -5.0 P+	
LM2990S-5.0/NOPB	ACTIVE	DDPAK/ TO-263	KTT	3	45	Pb-Free (RoHS Exempt)	CU SN	Level-3-245C-168 HR	-40 to 125	LM2990S -5.0 P+	Samples
LM2990SX-12	NRND	DDPAK/ TO-263	KTT	3	500	TBD	Call TI	Call TI	-40 to 125	LM2990S -12 P+	
LM2990SX-12/NOPB	ACTIVE	DDPAK/ TO-263	KTT	3	500	Pb-Free (RoHS Exempt)	CU SN	Level-3-245C-168 HR	-40 to 125	LM2990S -12 P+	Samples
LM2990SX-15	NRND	DDPAK/ TO-263	KTT	3	500	TBD	Call TI	Call TI	-40 to 125	LM2990S -15 P+	
LM2990SX-15/NOPB	ACTIVE	DDPAK/ TO-263	KTT	3	500	Pb-Free (RoHS Exempt)	CU SN	Level-3-245C-168 HR	-40 to 125	LM2990S -15 P+	Samples
LM2990SX-5.0	NRND	DDPAK/ TO-263	KTT	3	500	TBD	Call TI	Call TI	-40 to 125	LM2990S -5.0 P+	
LM2990SX-5.0/NOPB	ACTIVE	DDPAK/ TO-263	KTT	3	500	Pb-Free (RoHS Exempt)	CU SN	Level-3-245C-168 HR	-40 to 125	LM2990S -5.0 P+	Samples
LM2990T-12	NRND	TO-220	NDE	3	45	TBD	Call TI	Call TI	-40 to 125	LM2990T -12 P+	
LM2990T-12/NOPB	ACTIVE	TO-220	NDE	3	45	Green (RoHS & no Sb/Br)	CU SN	Level-1-NA-UNLIM	-40 to 125	LM2990T -12 P+	Samples
LM2990T-15	NRND	TO-220	NDE	3	45	TBD	Call TI	Call TI	-40 to 125	LM2990T -15 P+	
LM2990T-15/NOPB	ACTIVE	TO-220	NDE	3	45	Green (RoHS & no Sb/Br)	CU SN	Level-1-NA-UNLIM	-40 to 125	LM2990T -15 P+	Samples
LM2990T-5.0	NRND	TO-220	NDE	3	45	TBD	Call TI	Call TI	-40 to 125	LM2990T -5.0 P+	

Orderable Device	Status (1)	Package Type	Package Drawing	Pins	Package Qty	Eco Plan (2)	Lead/Ball Finish (6)	MSL Peak Temp (3)	Op Temp (°C)	Device Marking (4/5)	Samples
LM2990T-5.0/NOPB	ACTIVE	TO-220	NDE	3	45	Pb-Free (RoHS Exempt)	CU SN	Level-1-NA-UNLIM	-40 to 125	LM2990T -5.0 P+	
LM2990T-5.2	NRND	TO-220	NDE	3	45	TBD	Call TI	Call TI	-40 to 125	LM2990T -5.2 P+	
LM2990T-5.2/NOPB	ACTIVE	TO-220	NDE	3	45	Green (RoHS & no Sb/Br)	CU SN	Level-1-NA-UNLIM	-40 to 125	LM2990T -5.2 P+	

(1) The marketing status values are defined as follows:

ACTIVE: Product device recommended for new designs.

LIFEBUY: TI has announced that the device will be discontinued, and a lifetime-buy period is in effect.

NRND: Not recommended for new designs. Device is in production to support existing customers, but TI does not recommend using this part in a new design.

PREVIEW: Device has been announced but is not in production. Samples may or may not be available.

OBSOLETE: TI has discontinued the production of the device.

(2) Eco Plan - The planned eco-friendly classification: Pb-Free (RoHS), Pb-Free (RoHS Exempt), or Green (RoHS & no Sb/Br) - please check <http://www.ti.com/productcontent> for the latest availability information and additional product content details.

TBD: The Pb-Free/Green conversion plan has not been defined.

Pb-Free (RoHS): TI's terms "Lead-Free" or "Pb-Free" mean semiconductor products that are compatible with the current RoHS requirements for all 6 substances, including the requirement that lead not exceed 0.1% by weight in homogeneous materials. Where designed to be soldered at high temperatures, TI Pb-Free products are suitable for use in specified lead-free processes.

Pb-Free (RoHS Exempt): This component has a RoHS exemption for either 1) lead-based flip-chip solder bumps used between the die and package, or 2) lead-based die adhesive used between the die and leadframe. The component is otherwise considered Pb-Free (RoHS compatible) as defined above.

Green (RoHS & no Sb/Br): TI defines "Green" to mean Pb-Free (RoHS compatible), and free of Bromine (Br) and Antimony (Sb) based flame retardants (Br or Sb do not exceed 0.1% by weight in homogeneous material)

(3) MSL, Peak Temp. - The Moisture Sensitivity Level rating according to the JEDEC industry standard classifications, and peak solder temperature.

(4) There may be additional marking, which relates to the logo, the lot trace code information, or the environmental category on the device.

(5) Multiple Device Markings will be inside parentheses. Only one Device Marking contained in parentheses and separated by a "~" will appear on a device. If a line is indented then it is a continuation of the previous line and the two combined represent the entire Device Marking for that device.

(6) Lead/Ball Finish - Orderable Devices may have multiple material finish options. Finish options are separated by a vertical ruled line. Lead/Ball Finish values may wrap to two lines if the finish value exceeds the maximum column width.

Important Information and Disclaimer: The information provided on this page represents TI's knowledge and belief as of the date that it is provided. TI bases its knowledge and belief on information provided by third parties, and makes no representation or warranty as to the accuracy of such information. Efforts are underway to better integrate information from third parties. TI has taken and continues to take reasonable steps to provide representative and accurate information but may not have conducted destructive testing or chemical analysis on incoming materials and chemicals. TI and TI suppliers consider certain information to be proprietary, and thus CAS numbers and other limited information may not be available for release.

In no event shall TI's liability arising out of such information exceed the total purchase price of the TI part(s) at issue in this document sold by TI to Customer on an annual basis.

TAPE AND REEL INFORMATION

QUADRANT ASSIGNMENTS FOR PIN 1 ORIENTATION IN TAPE

*All dimensions are nominal

Device	Package Type	Package Drawing	Pins	SPQ	Reel Diameter (mm)	Reel Width W1 (mm)	A0 (mm)	B0 (mm)	K0 (mm)	P1 (mm)	W (mm)	Pin1 Quadrant
LM2990SX-12	DDPAK/ TO-263	KTT	3	500	330.0	24.4	10.75	14.85	5.0	16.0	24.0	Q2
LM2990SX-12/NOPB	DDPAK/ TO-263	KTT	3	500	330.0	24.4	10.75	14.85	5.0	16.0	24.0	Q2
LM2990SX-15	DDPAK/ TO-263	KTT	3	500	330.0	24.4	10.75	14.85	5.0	16.0	24.0	Q2
LM2990SX-15/NOPB	DDPAK/ TO-263	KTT	3	500	330.0	24.4	10.75	14.85	5.0	16.0	24.0	Q2
LM2990SX-5.0	DDPAK/ TO-263	KTT	3	500	330.0	24.4	10.75	14.85	5.0	16.0	24.0	Q2
LM2990SX-5.0/NOPB	DDPAK/ TO-263	KTT	3	500	330.0	24.4	10.75	14.85	5.0	16.0	24.0	Q2

TAPE AND REEL BOX DIMENSIONS



*All dimensions are nominal

Device	Package Type	Package Drawing	Pins	SPQ	Length (mm)	Width (mm)	Height (mm)
LM2990SX-12	DDPAK/TO-263	KTT	3	500	367.0	367.0	45.0
LM2990SX-12/NOPB	DDPAK/TO-263	KTT	3	500	367.0	367.0	45.0
LM2990SX-15	DDPAK/TO-263	KTT	3	500	367.0	367.0	45.0
LM2990SX-15/NOPB	DDPAK/TO-263	KTT	3	500	367.0	367.0	45.0
LM2990SX-5.0	DDPAK/TO-263	KTT	3	500	367.0	367.0	45.0
LM2990SX-5.0/NOPB	DDPAK/TO-263	KTT	3	500	367.0	367.0	45.0

NDE0003B

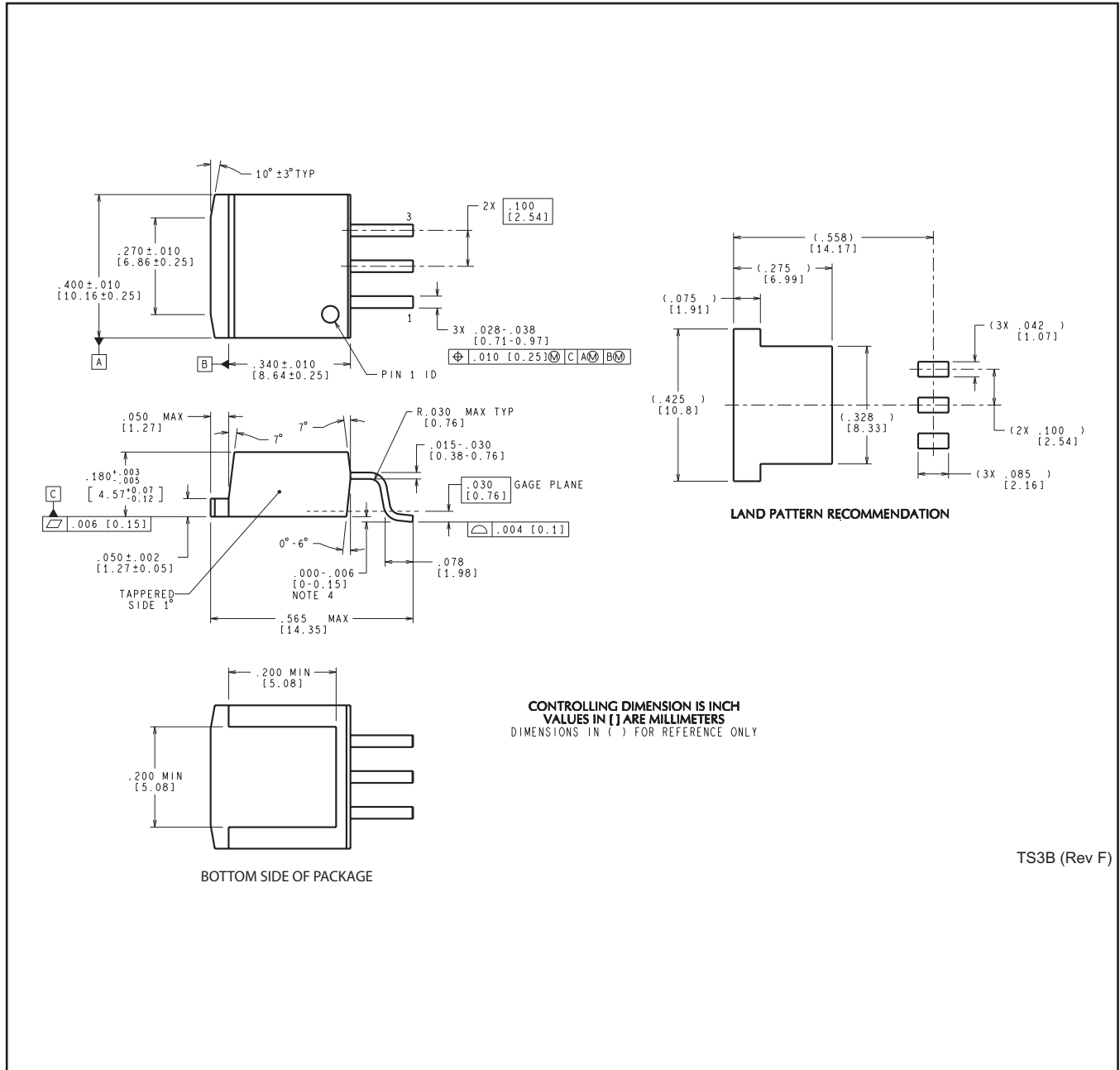

KTT0003B



IMPORTANT NOTICE

Texas Instruments Incorporated and its subsidiaries (TI) reserve the right to make corrections, enhancements, improvements and other changes to its semiconductor products and services per JESD46, latest issue, and to discontinue any product or service per JESD48, latest issue. Buyers should obtain the latest relevant information before placing orders and should verify that such information is current and complete. All semiconductor products (also referred to herein as "components") are sold subject to TI's terms and conditions of sale supplied at the time of order acknowledgment.

TI warrants performance of its components to the specifications applicable at the time of sale, in accordance with the warranty in TI's terms and conditions of sale of semiconductor products. Testing and other quality control techniques are used to the extent TI deems necessary to support this warranty. Except where mandated by applicable law, testing of all parameters of each component is not necessarily performed.

TI assumes no liability for applications assistance or the design of Buyers' products. Buyers are responsible for their products and applications using TI components. To minimize the risks associated with Buyers' products and applications, Buyers should provide adequate design and operating safeguards.

TI does not warrant or represent that any license, either express or implied, is granted under any patent right, copyright, mask work right, or other intellectual property right relating to any combination, machine, or process in which TI components or services are used. Information published by TI regarding third-party products or services does not constitute a license to use such products or services or a warranty or endorsement thereof. Use of such information may require a license from a third party under the patents or other intellectual property of the third party, or a license from TI under the patents or other intellectual property of TI.

Reproduction of significant portions of TI information in TI data books or data sheets is permissible only if reproduction is without alteration and is accompanied by all associated warranties, conditions, limitations, and notices. TI is not responsible or liable for such altered documentation. Information of third parties may be subject to additional restrictions.

Resale of TI components or services with statements different from or beyond the parameters stated by TI for that component or service voids all express and any implied warranties for the associated TI component or service and is an unfair and deceptive business practice. TI is not responsible or liable for any such statements.

Buyer acknowledges and agrees that it is solely responsible for compliance with all legal, regulatory and safety-related requirements concerning its products, and any use of TI components in its applications, notwithstanding any applications-related information or support that may be provided by TI. Buyer represents and agrees that it has all the necessary expertise to create and implement safeguards which anticipate dangerous consequences of failures, monitor failures and their consequences, lessen the likelihood of failures that might cause harm and take appropriate remedial actions. Buyer will fully indemnify TI and its representatives against any damages arising out of the use of any TI components in safety-critical applications.

In some cases, TI components may be promoted specifically to facilitate safety-related applications. With such components, TI's goal is to help enable customers to design and create their own end-product solutions that meet applicable functional safety standards and requirements. Nonetheless, such components are subject to these terms.

No TI components are authorized for use in FDA Class III (or similar life-critical medical equipment) unless authorized officers of the parties have executed a special agreement specifically governing such use.

Only those TI components which TI has specifically designated as military grade or "enhanced plastic" are designed and intended for use in military/aerospace applications or environments. Buyer acknowledges and agrees that any military or aerospace use of TI components which have **not** been so designated is solely at the Buyer's risk, and that Buyer is solely responsible for compliance with all legal and regulatory requirements in connection with such use.

TI has specifically designated certain components as meeting ISO/TS16949 requirements, mainly for automotive use. In any case of use of non-designated products, TI will not be responsible for any failure to meet ISO/TS16949.

Products

Audio	www.ti.com/audio
Amplifiers	amplifier.ti.com
Data Converters	dataconverter.ti.com
DLP® Products	www.dlp.com
DSP	dsp.ti.com
Clocks and Timers	www.ti.com/clocks
Interface	interface.ti.com
Logic	logic.ti.com
Power Mgmt	power.ti.com
Microcontrollers	microcontroller.ti.com
RFID	www.ti-rfid.com
OMAP Applications Processors	www.ti.com/omap
Wireless Connectivity	www.ti.com/wirelessconnectivity

Applications

Automotive and Transportation	www.ti.com/automotive
Communications and Telecom	www.ti.com/communications
Computers and Peripherals	www.ti.com/computers
Consumer Electronics	www.ti.com/consumer-apps
Energy and Lighting	www.ti.com/energy
Industrial	www.ti.com/industrial
Medical	www.ti.com/medical
Security	www.ti.com/security
Space, Avionics and Defense	www.ti.com/space-avionics-defense
Video and Imaging	www.ti.com/video

TI E2E Community

e2e.ti.com