

LM140LQML Series 3-Terminal Positive Regulators

Check for Samples: [LM140LQML](#)

FEATURES

- Line Regulation of 0.04%/V
- Load Regulation of 0.01%/mA
- Output Voltage Tolerances of $\pm 2\%$ at $T_j = 25^\circ\text{C}$ and $\pm 4\%$ over the Temperature Range
- Output Current of 100 mA
- Internal Thermal Overload Protection
- Output Transistor Safe Area Protection
- Internal Short Circuit Current Limit

DESCRIPTION

The LM140L series of three terminal positive regulators is available with several fixed output voltages making them useful in a wide range of applications. The LM140LA is an improved version of the LM78LXX series with a tighter output voltage tolerance (specified over the full military temperature range), higher ripple rejection, better regulation and lower quiescent current. The LM140LA regulators have $\pm 2\%$ V_{OUT} specification, 0.04%/V line regulation, and 0.01%/mA load regulation. When used as a zener diode/resistor combination replacement, the LM140LA usually results in an effective output impedance improvement of two orders of magnitude, and lower quiescent current. These regulators can provide local on card regulation, eliminating the distribution problems associated with single point regulation. The voltages available allow the LM140LA to be used in logic systems, instrumentation, Hi-Fi, and other solid state electronic equipment. Although designed primarily as fixed voltage regulators, these devices can be used with external components to obtain adjustable voltages and currents.

With adequate heat sinking the regulator can deliver 100 mA output current. Current limiting is included to limit the peak output current to a safe value. Safe area protection for the output transistor is provided to limit internal power dissipation. If internal power dissipation becomes too high for the heat sinking provided, the thermal shut-down circuit takes over, preventing the IC from overheating.

Output Voltage Options

Device ID	Output Voltage
LM140LA-5.0	5V
LM140LA-12	12V
LM140LA-15	15V



Please be aware that an important notice concerning availability, standard warranty, and use in critical applications of Texas Instruments semiconductor products and disclaimers thereto appears at the end of this data sheet.

All trademarks are the property of their respective owners.

Connection Diagrams

TO-39 Metal Can Package

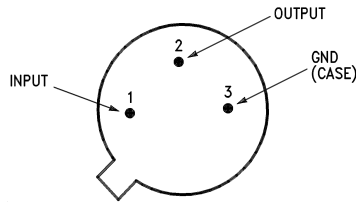
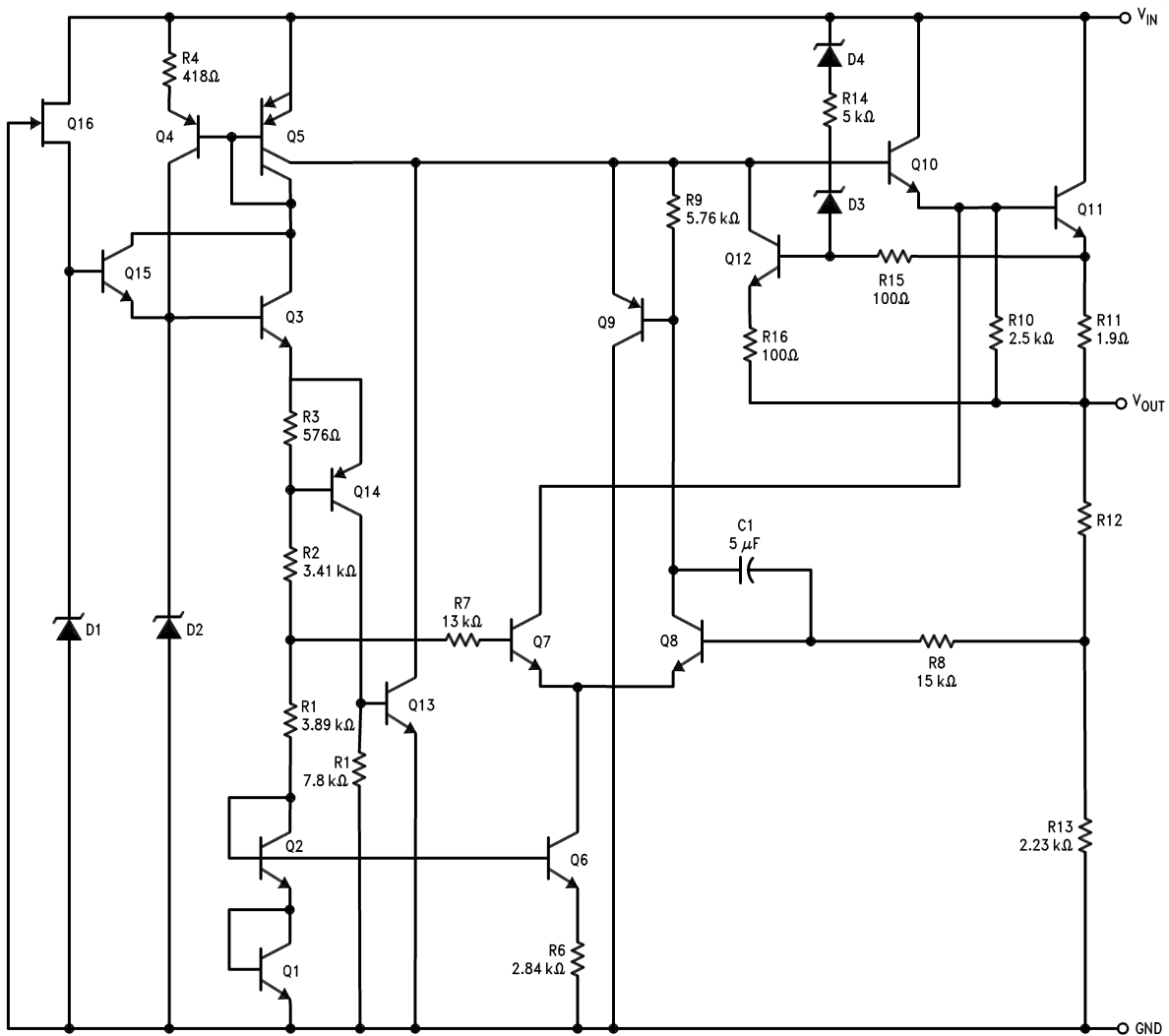

Figure 1. Bottom View
See Package NDT0003A

Equivalent Circuit



These devices have limited built-in ESD protection. The leads should be shorted together or the device placed in conductive foam during storage or handling to prevent electrostatic damage to the MOS gates.

Absolute Maximum Ratings⁽¹⁾

Input Voltage		35V	
Internal Power Dissipation ⁽²⁾		Internally Limited	
Operating Temperature Range		-55°C ≤ T _A ≤ +125°C	
Maximum Junction Temperature		+150°C	
Storage Temperature Range		-65°C ≤ T _A ≤ +150°C	
Lead Temperature (Soldering, 10 sec.)		+300°C	
Thermal Resistance	θ _{JA}	Still Air @ 0.5W	201°C/W
		500LF / Min Air Flow @ 0.5W	79°C/W
	θ _{JC} (@ 1.0W)		38°C/W
ESD Susceptibility ⁽³⁾		TBD	

- (1) Absolute Maximum Ratings indicate limits beyond which damage to the device may occur. Operating Ratings indicate conditions for which the device is functional, but do not specify specific performance limits. For ensured specifications and test conditions, see the Electrical Characteristics. The ensured specifications apply only for the test conditions listed. Some performance characteristics may degrade when the device is not operated under the listed test conditions.
- (2) The maximum power dissipation must be derated at elevated temperatures and is dictated by T_{Jmax} (maximum junction temperature), θ_{JA} (package junction to ambient thermal resistance), and T_A (ambient temperature). The maximum allowable power dissipation at any temperature is P_{Dmax} = (T_{Jmax} - T_A)/θ_{JA} or the number given in the Absolute Maximum Ratings, whichever is lower.
- (3) Human body model, 100pF discharged through 1.5KΩ

Quality Conformance Inspection

Mil-Std-883, Method 5005 - Group A

Subgroup	Description	Temp °C
1	Static tests at	25
2	Static tests at	125
3	Static tests at	-55
4	Dynamic tests at	25
5	Dynamic tests at	125
6	Dynamic tests at	-55
7	Functional tests at	25
8A	Functional tests at	125
8B	Functional tests at	-55
9	Switching tests at	25
10	Switching tests at	125
11	Switching tests at	-55
12	Settling time at	25
13	Settling time at	125
14	Settling time at	-55

LM140LA-5.0 Electrical Characteristics DC Parameters

The following conditions apply, unless otherwise specified. DC: $V_I = 10V$, $I_L = 40mA$

Symbol	Parameter	Conditions	Notes	Min	Max	Unit	Sub-groups
I_Q	Quiescent Current				4.5	mA	1
					4.2	mA	2
V_O	Output Voltage			4.9	5.1	V	1
		$V_I = 20V$, $I_L = 5mA$		4.8	5.2	V	1, 2, 3
		$V_I = 20V$, $I_L = 100mA$		4.8	5.2	V	1, 2, 3
		$V_I = 7.2V$, $I_L = 5mA$		4.8	5.2	V	1, 2, 3
		$V_I = 7.2V$, $I_L = 100mA$		4.8	5.2	V	1, 2, 3
R_{Load}	Load Regulation	$5mA \leq I_L \leq 40mA$		-20	20	mV	1
		$5mA \leq I_L \leq 100mA$		-40	40	mV	1
R_{Line}	Line Regulation	$I_L = 100mA$, $7.5V \leq V_I \leq 25V$		-30	30	mV	1
		$7V \leq V_I \leq 25V$		-30	30	mV	1
ΔI_Q	Quiescent Current Change	$5mA \leq I_L \leq 40mA$		-0.1	0.1	mA	1, 2, 3
		$7.5V \leq V_I \leq 35V$		-0.5	0.5	mA	1

LM140LA-5.0 Electrical Characteristics AC Parameters

Symbol	Parameter	Conditions	Notes	Min	Max	Unit	Sub-groups
RR	Ripple Rejection	$f = 120Hz$, $e_i = 1V_{RMS}$		55		dB	4

LM140LA-12 Electrical Characteristics DC Parameters

The following conditions apply, unless otherwise specified. DC: $V_I = 19V$, $I_L = 40mA$

Symbol	Parameter	Conditions	Notes	Min	Max	Unit	Sub-groups
I_Q	Quiescent Current				4.5	mA	1
					4.2	mA	2
V_O	Output Voltage			11.75	12.25	V	1
		$V_I = 27V$, $I_L = 5mA$		11.5	12.5	V	1, 2, 3
		$V_I = 27V$, $I_L = 100mA$		11.5	12.5	V	1, 2, 3
		$V_I = 14.5V$, $I_L = 5mA$		11.5	12.5	V	1, 2, 3
		$V_I = 14.5V$, $I_L = 100mA$		11.5	12.5	V	1, 2, 3
R_{Load}	Load Regulation	$5mA \leq I_L \leq 40mA$		-40	40	mV	1
		$5mA \leq I_L \leq 100mA$		-80	80	mV	1
R_{Line}	Line Regulation	$I_L = 100mA$, $14.5V \leq V_I \leq 30V$		-65	65	mV	1
		$14.2V \leq V_I \leq 30V$		-65	65	mV	1
ΔI_Q	Quiescent Current Change	$5mA \leq I_L \leq 40mA$		-0.1	0.1	mA	1, 2, 3
		$14.3V \leq V_I \leq 35V$		-0.5	0.5	mA	1

LM140LA-12 Electrical Characteristics AC Parameters

Symbol	Parameter	Conditions	Notes	Min	Max	Unit	Sub-groups
RR	Ripple Rejection	$f = 120Hz$, $e_i = 1V_{RMS}$		47		dB	4

LM140LA-15 Electrical Characteristics DC Parameters

The following conditions apply, unless otherwise specified. DC: $V_I = 23V$, $I_L = 40mA$

Symbol	Parameter	Conditions	Notes	Min	Max	Unit	Sub-groups
I_Q	Quiescent Current				4.5	mA	1
					4.2	mA	2
V_O	Output Voltage			14.7	15.3	V	1
		$V_I = 30V$, $I_L = 5mA$		14.4	15.6	V	1, 2, 3
		$V_I = 30V$, $I_L = 100mA$		14.4	15.6	V	1, 2, 3
		$V_I = 17.6V$, $I_L = 5mA$		14.4	15.6	V	1, 2, 3
		$V_I = 17.6V$, $I_L = 100mA$		14.4	15.6	V	1, 2, 3
R_{Load}	Load Regulation	$5mA \leq I_L \leq 40mA$		-50	50	mV	1
		$5mA \leq I_L \leq 100mA$		-100	100	mV	1
R_{Line}	Line Regulation	$I_L = 100mA$, $17.3V \leq V_I \leq 30V$		-70	70	mV	1
		$17.3V \leq V_I \leq 30V$		-70	70	mV	1
ΔI_Q	Quiescent Current Change	$5mA \leq I_L \leq 40mA$		-0.1	0.1	mA	1, 2, 3
		$17.5V \leq V_I \leq 35V$		-0.5	0.5	mA	1

LM140LA-15 Electrical Characteristics AC Parameters

Symbol	Parameter	Conditions	Notes	Min	Max	Unit	Sub-groups
RR	Ripple Rejection f	$f = 120Hz$, $e_i = 1V_{RMS}$		47		dB	4

Typical Performance Characteristics

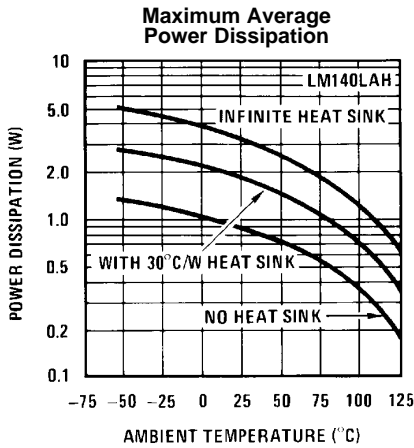

Figure 2.

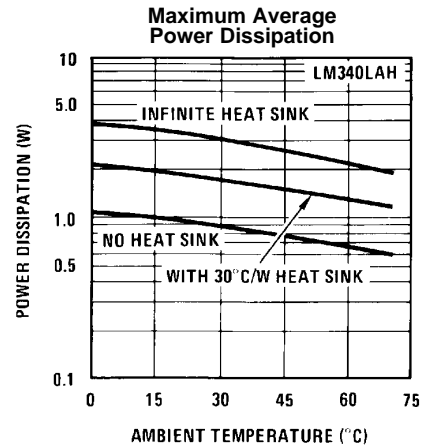

Figure 3.

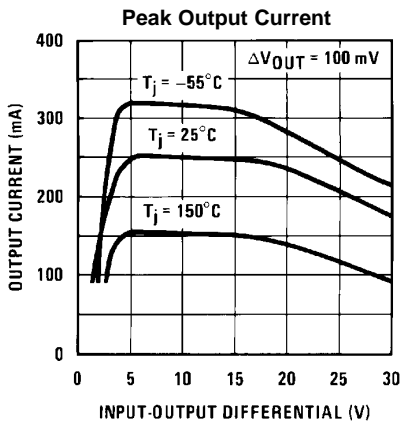

Figure 4.

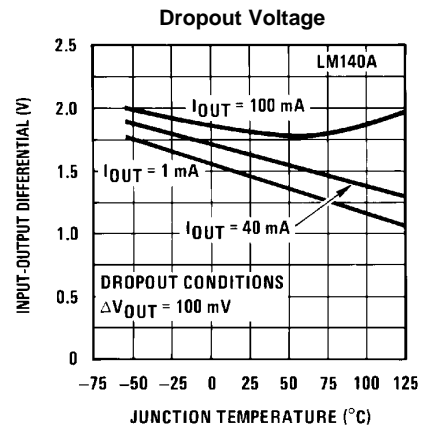

Figure 5.

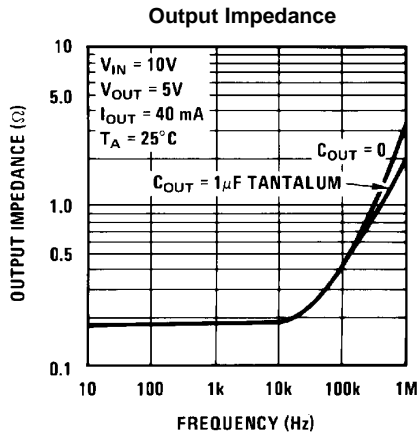

Figure 6.

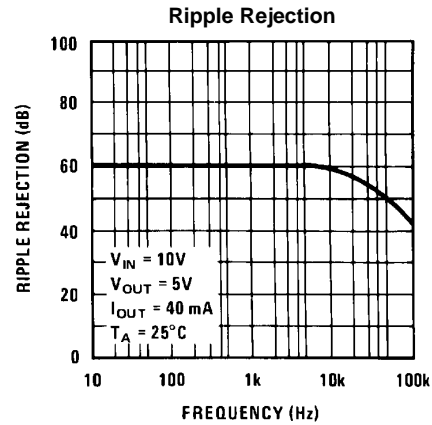
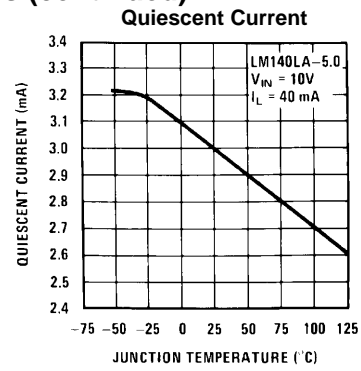
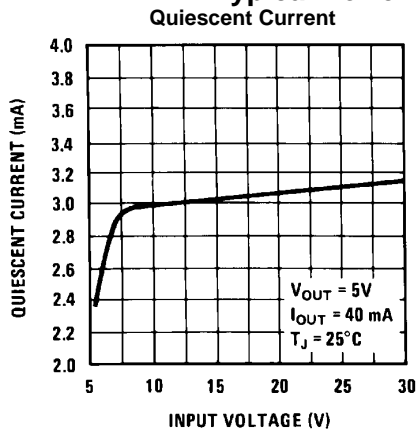

Figure 7.

Typical Performance Characteristics (continued)



TYPICAL APPLICATIONS

NOTE

It is recommended that a minimum load capacitor of 0.01 μF be used to limit the high frequency noise bandwidth.

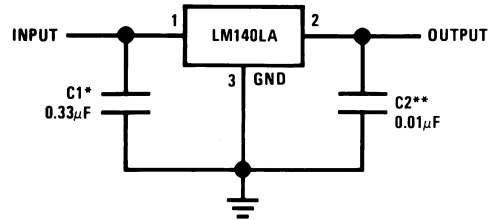

*Required if the regulator is located far from the power supply filter.

**Human body model, 100pF discharged through 1.5K Ω

Figure 10. Fixed Output Regulator

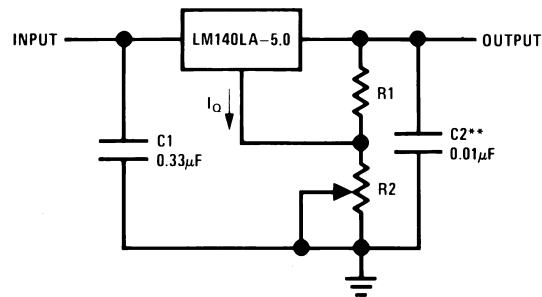

$$V_{OUT} = 5V + (5V/R1 + I_O) R2$$



$$5V/R1 = 3 I_O \text{ load regulation (L.) } [(R1 + R2)/R1] \text{ (L. of LM140LA-5.0)}$$

Figure 11. Adjustable Output Regulator

Revision History

Released	Revision	Section	Originator	Changes
03/10/06	A	New release to corporate format	L. Lytle	3 MDS data sheets converted into one Corp. data sheet format. Drift tables were removed from electrical characteristics since not performed on 883 product. MDS data sheets MNLM140LA-05-H Rev. 0B0, MNLM140LA-12-H Rev. 0B0 and MNLM140LA-15-H Rev. 0B0. will be archived.
05/02/13	A			Changed layout of National Data Sheet to TI format.

PACKAGING INFORMATION

Orderable Device	Status (1)	Package Type	Package Drawing	Pins	Package Qty	Eco Plan (2)	Lead/Ball Finish	MSL Peak Temp (3)	Op Temp (°C)	Top-Side Markings (4)	Samples
LM140LAH-12/883	ACTIVE	TO	NDT	3	20	TBD	Call TI	Call TI	-55 to 125	LM140LAH-12/883 Q ACO LM140LAH-12/883 Q >T	
LM140LAH-15/883	ACTIVE	TO	NDT	3	20	TBD	Call TI	Call TI	-55 to 125	LM140LAH-15/883 Q ACO LM140LAH-15/883 Q >T	
LM140LAH5.0/883	ACTIVE	TO	NDT	3	20	TBD	Call TI	Call TI	-55 to 125	LM140LAH5.0/883 Q ACO LM140LAH5.0/883 Q >T	

(1) The marketing status values are defined as follows:

ACTIVE: Product device recommended for new designs.

LIFEBUY: TI has announced that the device will be discontinued, and a lifetime-buy period is in effect.

NRND: Not recommended for new designs. Device is in production to support existing customers, but TI does not recommend using this part in a new design.

PREVIEW: Device has been announced but is not in production. Samples may or may not be available.

OBSOLETE: TI has discontinued the production of the device.

(2) Eco Plan - The planned eco-friendly classification: Pb-Free (RoHS), Pb-Free (RoHS Exempt), or Green (RoHS & no Sb/Br) - please check <http://www.ti.com/productcontent> for the latest availability information and additional product content details.

TBD: The Pb-Free/Green conversion plan has not been defined.

Pb-Free (RoHS): TI's terms "Lead-Free" or "Pb-Free" mean semiconductor products that are compatible with the current RoHS requirements for all 6 substances, including the requirement that lead not exceed 0.1% by weight in homogeneous materials. Where designed to be soldered at high temperatures, TI Pb-Free products are suitable for use in specified lead-free processes.

Pb-Free (RoHS Exempt): This component has a RoHS exemption for either 1) lead-based flip-chip solder bumps used between the die and package, or 2) lead-based die adhesive used between the die and leadframe. The component is otherwise considered Pb-Free (RoHS compatible) as defined above.

Green (RoHS & no Sb/Br): TI defines "Green" to mean Pb-Free (RoHS compatible), and free of Bromine (Br) and Antimony (Sb) based flame retardants (Br or Sb do not exceed 0.1% by weight in homogeneous material)

(3) MSL, Peak Temp. -- The Moisture Sensitivity Level rating according to the JEDEC industry standard classifications, and peak solder temperature.

(4) Multiple Top-Side Markings will be inside parentheses. Only one Top-Side Marking contained in parentheses and separated by a "~" will appear on a device. If a line is indented then it is a continuation of the previous line and the two combined represent the entire Top-Side Marking for that device.

Important Information and Disclaimer: The information provided on this page represents TI's knowledge and belief as of the date that it is provided. TI bases its knowledge and belief on information provided by third parties, and makes no representation or warranty as to the accuracy of such information. Efforts are underway to better integrate information from third parties. TI has taken and

continues to take reasonable steps to provide representative and accurate information but may not have conducted destructive testing or chemical analysis on incoming materials and chemicals. TI and TI suppliers consider certain information to be proprietary, and thus CAS numbers and other limited information may not be available for release.

In no event shall TI's liability arising out of such information exceed the total purchase price of the TI part(s) at issue in this document sold by TI to Customer on an annual basis.

NDT0003A

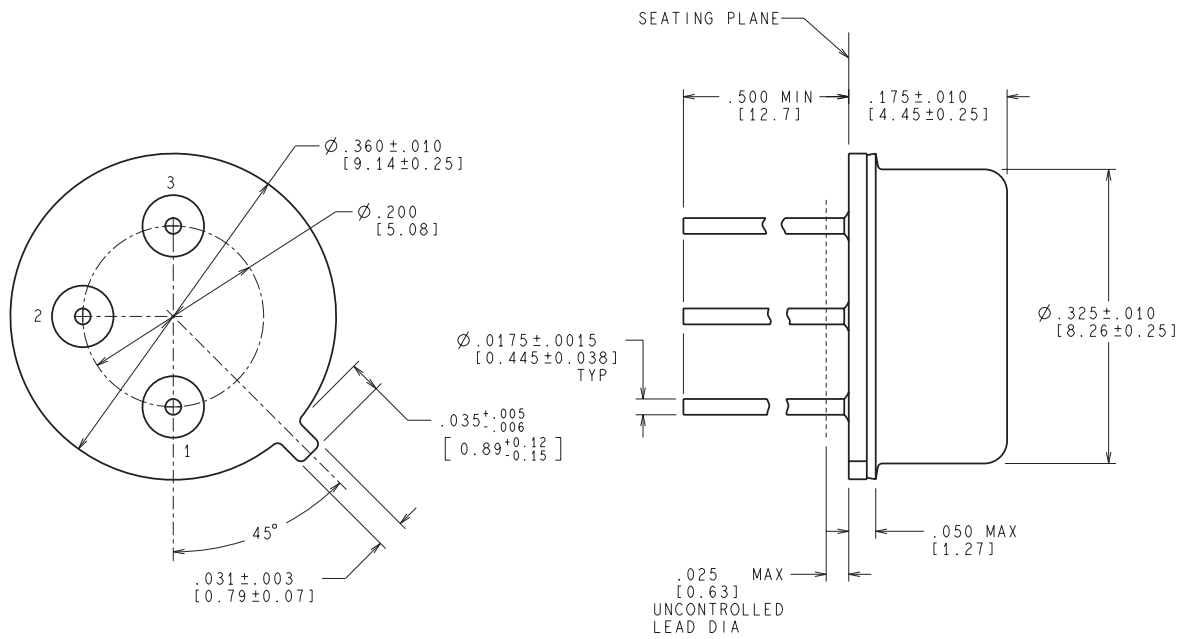

CONTROLLING DIMENSION IS INCH
VALUES IN [] ARE MILLIMETERS

MIL-PRF-38535
CONFIGURATION CONTROL

H03A (Rev D)

IMPORTANT NOTICE

Texas Instruments Incorporated and its subsidiaries (TI) reserve the right to make corrections, enhancements, improvements and other changes to its semiconductor products and services per JESD46, latest issue, and to discontinue any product or service per JESD48, latest issue. Buyers should obtain the latest relevant information before placing orders and should verify that such information is current and complete. All semiconductor products (also referred to herein as "components") are sold subject to TI's terms and conditions of sale supplied at the time of order acknowledgment.

TI warrants performance of its components to the specifications applicable at the time of sale, in accordance with the warranty in TI's terms and conditions of sale of semiconductor products. Testing and other quality control techniques are used to the extent TI deems necessary to support this warranty. Except where mandated by applicable law, testing of all parameters of each component is not necessarily performed.

TI assumes no liability for applications assistance or the design of Buyers' products. Buyers are responsible for their products and applications using TI components. To minimize the risks associated with Buyers' products and applications, Buyers should provide adequate design and operating safeguards.

TI does not warrant or represent that any license, either express or implied, is granted under any patent right, copyright, mask work right, or other intellectual property right relating to any combination, machine, or process in which TI components or services are used. Information published by TI regarding third-party products or services does not constitute a license to use such products or services or a warranty or endorsement thereof. Use of such information may require a license from a third party under the patents or other intellectual property of the third party, or a license from TI under the patents or other intellectual property of TI.

Reproduction of significant portions of TI information in TI data books or data sheets is permissible only if reproduction is without alteration and is accompanied by all associated warranties, conditions, limitations, and notices. TI is not responsible or liable for such altered documentation. Information of third parties may be subject to additional restrictions.

Resale of TI components or services with statements different from or beyond the parameters stated by TI for that component or service voids all express and any implied warranties for the associated TI component or service and is an unfair and deceptive business practice. TI is not responsible or liable for any such statements.

Buyer acknowledges and agrees that it is solely responsible for compliance with all legal, regulatory and safety-related requirements concerning its products, and any use of TI components in its applications, notwithstanding any applications-related information or support that may be provided by TI. Buyer represents and agrees that it has all the necessary expertise to create and implement safeguards which anticipate dangerous consequences of failures, monitor failures and their consequences, lessen the likelihood of failures that might cause harm and take appropriate remedial actions. Buyer will fully indemnify TI and its representatives against any damages arising out of the use of any TI components in safety-critical applications.

In some cases, TI components may be promoted specifically to facilitate safety-related applications. With such components, TI's goal is to help enable customers to design and create their own end-product solutions that meet applicable functional safety standards and requirements. Nonetheless, such components are subject to these terms.

No TI components are authorized for use in FDA Class III (or similar life-critical medical equipment) unless authorized officers of the parties have executed a special agreement specifically governing such use.

Only those TI components which TI has specifically designated as military grade or "enhanced plastic" are designed and intended for use in military/aerospace applications or environments. Buyer acknowledges and agrees that any military or aerospace use of TI components which have **not** been so designated is solely at the Buyer's risk, and that Buyer is solely responsible for compliance with all legal and regulatory requirements in connection with such use.

TI has specifically designated certain components as meeting ISO/TS16949 requirements, mainly for automotive use. In any case of use of non-designated products, TI will not be responsible for any failure to meet ISO/TS16949.

Products

Audio	www.ti.com/audio
Amplifiers	amplifier.ti.com
Data Converters	dataconverter.ti.com
DLP® Products	www.dlp.com
DSP	dsp.ti.com
Clocks and Timers	www.ti.com/clocks
Interface	interface.ti.com
Logic	logic.ti.com
Power Mgmt	power.ti.com
Microcontrollers	microcontroller.ti.com
RFID	www.ti-rfid.com
OMAP Applications Processors	www.ti.com/omap
Wireless Connectivity	www.ti.com/wirelessconnectivity

Applications

Automotive and Transportation	www.ti.com/automotive
Communications and Telecom	www.ti.com/communications
Computers and Peripherals	www.ti.com/computers
Consumer Electronics	www.ti.com/consumer-apps
Energy and Lighting	www.ti.com/energy
Industrial	www.ti.com/industrial
Medical	www.ti.com/medical
Security	www.ti.com/security
Space, Avionics and Defense	www.ti.com/space-avionics-defense
Video and Imaging	www.ti.com/video

TI E2E Community

e2e.ti.com