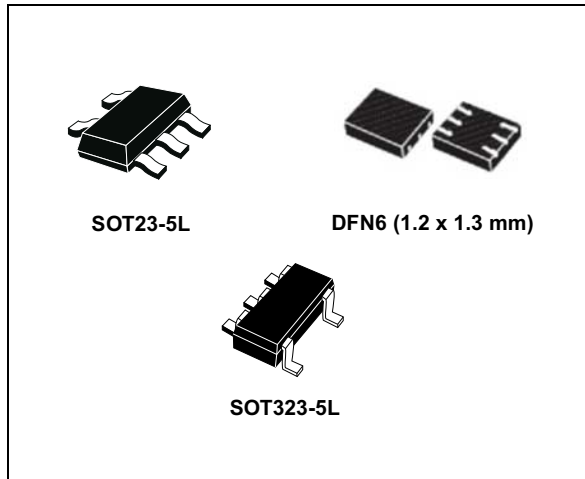

**300 mA low quiescent current very low noise LDO**

Datasheet - production data

**Features**

- Input voltage from 1.9 to 5.5 V
- Very low dropout voltage (100 mV typ. at 100 mA load)
- Low quiescent current (max. 120  $\mu$ A, 1  $\mu$ A in OFF mode)
- Very low noise
- Output voltage tolerance:  $\pm 2.0\%$  @ 25  $^{\circ}$ C
- 300 mA guaranteed output current
- Wide range of fixed output voltages available on request: from 0.8 V to 3.5 V with 100 mV step
- Adjustable version: from 0.8 V to  $V_{IN} - V_{drop}$
- Logic-controlled electronic shutdown
- Compatible with ceramic capacitor  $C_{OUT} = 1\ \mu$ F
- Internal current and thermal limit
- Available in SOT23-5L, SOT323-5L and DFN6 (1.2 x 1.3 mm) packages
- Temperature range: -40  $^{\circ}$ C to 125  $^{\circ}$ C

**Applications**

- Mobile phones
- Personal digital assistants (PDAs)
- Cordless phones and similar battery-powered systems
- Digital still cameras

**Description**

The LDK130 low drop voltage regulator provides 300 mA of maximum current from an input supply voltage in the range of 1.9 V to 5.5 V, with a typical dropout voltage of 100 mV.

It is stabilized with a ceramic capacitor on the output.

The very low drop voltage, low quiescent current and low noise features make it suitable for low power battery-powered applications.

An enable logic control function puts the LDK130 in shutdown mode allowing a total current consumption lower than 1  $\mu$ A.

The device also includes a short-circuit constant current limiting and thermal protection.

# Contents

1	Diagram .....	5
2	Pin configuration .....	6
3	Typical application .....	7
4	Maximum ratings .....	8
5	Electrical characteristics .....	9
6	Typical performance characteristics .....	11
7	Package mechanical data .....	17
8	Packaging mechanical data .....	23
9	Order codes .....	25
10	Revision history .....	26



## List of tables

Table 1.	Pin description (SOT23-5L, SOT323-5L).....	6
Table 2.	Absolute maximum ratings .....	8
Table 3.	Thermal data .....	8
Table 4.	Electrical characteristics for LDK130 (fixed version) .....	9
Table 5.	Electrical characteristics for LDK130 (adjustable version) .....	10
Table 6.	SOT23-5L mechanical data .....	18
Table 7.	DFN6L (1.2 x 1.3 mm) mechanical data .....	20
Table 8.	SOT323-5L mechanical data .....	22
Table 9.	SOT23-5L tape and reel mechanical data .....	24
Table 10.	SOT323-xL tape and reel mechanical data .....	24
Table 11.	Order codes .....	25
Table 12.	Marking .....	25
Table 13.	Document revision history .....	26

## List of figures

Figure 1.	Block diagram . . . . .	5
Figure 2.	Pin connection (top view) . . . . .	6
Figure 3.	Typical application circuits for fixed version . . . . .	7
Figure 4.	Typical application circuits for adjustable version . . . . .	7
Figure 5.	Output voltage vs. temp. for adjustable ( $I_O = 1 \text{ mA}$ ) . . . . .	11
Figure 6.	Output voltage vs. temp. for adjustable version ( $I_O = 300 \text{ mA}$ ) . . . . .	11
Figure 7.	Output voltage vs. temp. for fixed version ( $I_O = 1 \text{ mA}$ ) . . . . .	11
Figure 8.	Output voltage vs. temp. for fixed version ( $I_O = 300 \text{ mA}$ ) . . . . .	11
Figure 9.	Line regulation vs. temp. for adjustable version . . . . .	12
Figure 10.	Short-circuit current vs. temp. for adjustable version . . . . .	12
Figure 11.	Load regulation vs. temp. for adjustable version . . . . .	12
Figure 12.	Load regulation vs. temp. for fixed version . . . . .	12
Figure 13.	Enable pin thresholds vs. temp. ( $V_{IN} = 1.9 \text{ V}$ ) . . . . .	12
Figure 14.	Enable pin thresholds vs. temp. . . . .	12
Figure 15.	Quiescent current vs. temp. for adjustable version ( $I_O = 0 \text{ mA}$ ) . . . . .	13
Figure 16.	Quiescent current vs. temp. for adjustable version ( $I_O = 300 \text{ mA}$ ) . . . . .	13
Figure 17.	Quiescent current vs. temp. for fixed version ( $I_O = 0 \text{ mA}$ ) . . . . .	13
Figure 18.	Quiescent current vs. temp. for fixed version ( $I_O = 300 \text{ mA}$ ) . . . . .	13
Figure 19.	Shutdown current vs. temperature . . . . .	13
Figure 20.	SVR vs. frequency ( $V_O = 2.5 \text{ V}$ ) . . . . .	13
Figure 21.	SVR vs. frequency ( $V_O = V_{ADJ}$ ) . . . . .	14
Figure 22.	Output noise vs. frequency ( $V_O = 3.3 \text{ V}$ ) . . . . .	14
Figure 23.	Output noise vs. frequency ( $V_O = V_{ADJ}$ ) . . . . .	14
Figure 24.	Stability region vs. $C_{OUT}$ (fixed) . . . . .	14
Figure 25.	Stability region vs $C_{OUT}$ (adjust.) . . . . .	14
Figure 26.	Line transient ( $V_{OUT} = V_{ADJ}$ ) . . . . .	14
Figure 27.	Line transient ( $V_{OUT} = 3 \text{ V}$ ) . . . . .	15
Figure 28.	Load transient ( $V_{OUT} = 3 \text{ V}$ ) . . . . .	15
Figure 29.	Load transient ( $V_{OUT} = V_{ADJ}$ ) . . . . .	15
Figure 30.	Startup transient . . . . .	15
Figure 31.	Enable transient ( $V_{OUT} = V_{ADJ}$ ) . . . . .	16
Figure 32.	Enable transient ( $V_{OUT} = 3 \text{ V}$ ) . . . . .	16
Figure 33.	Dropout voltage vs. temperature ( $I_{OUT} = 100 \text{ mA}$ ) . . . . .	16
Figure 34.	Dropout voltage vs. temperature ( $I_{OUT} = 300 \text{ mA}$ ) . . . . .	16
Figure 35.	SOT23-5L mechanical drawing . . . . .	17
Figure 36.	SOT23-5L footprint (dimensions in mm) . . . . .	18
Figure 37.	DFN6L (1.2 x 1.3 mm) drawing . . . . .	19
Figure 38.	DFN6L footprint (dimensions in mm) . . . . .	20
Figure 39.	SOT323-5L drawing . . . . .	21
Figure 40.	TSOT23-5L and SOT323-xL tape and reel drawing . . . . .	23

# 1 Diagram

Figure 1. Block diagram

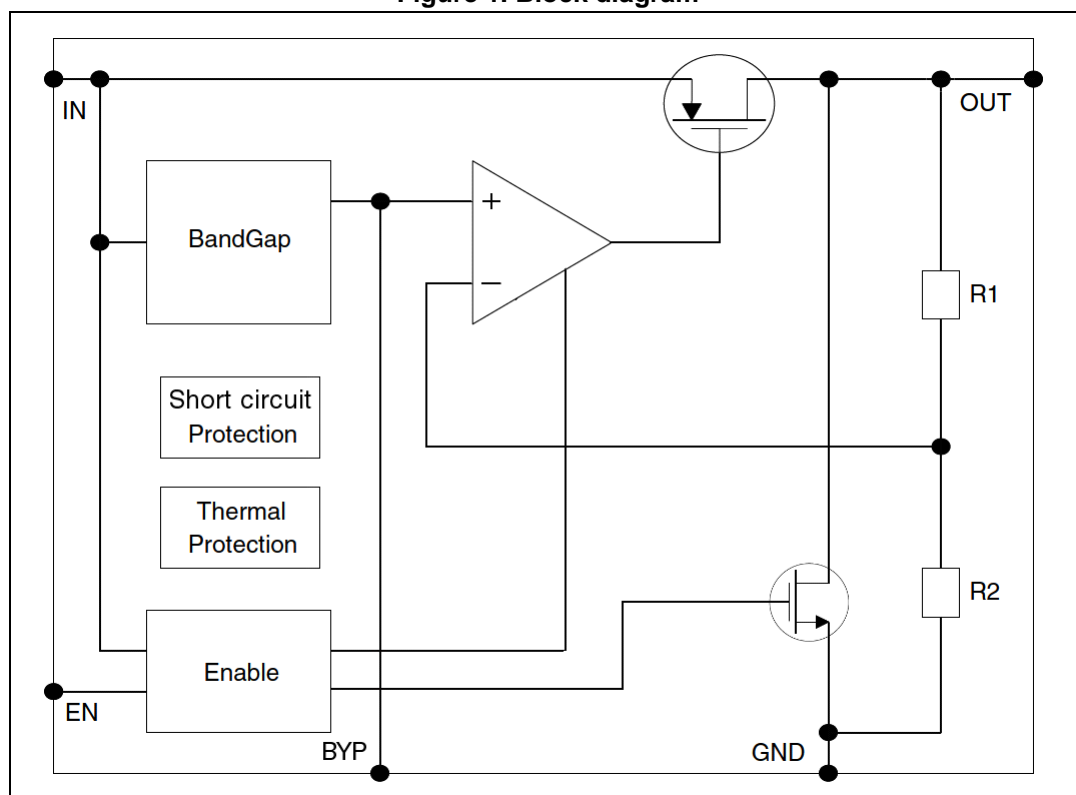

## 2 Pin configuration

Figure 2. Pin connection (top view)

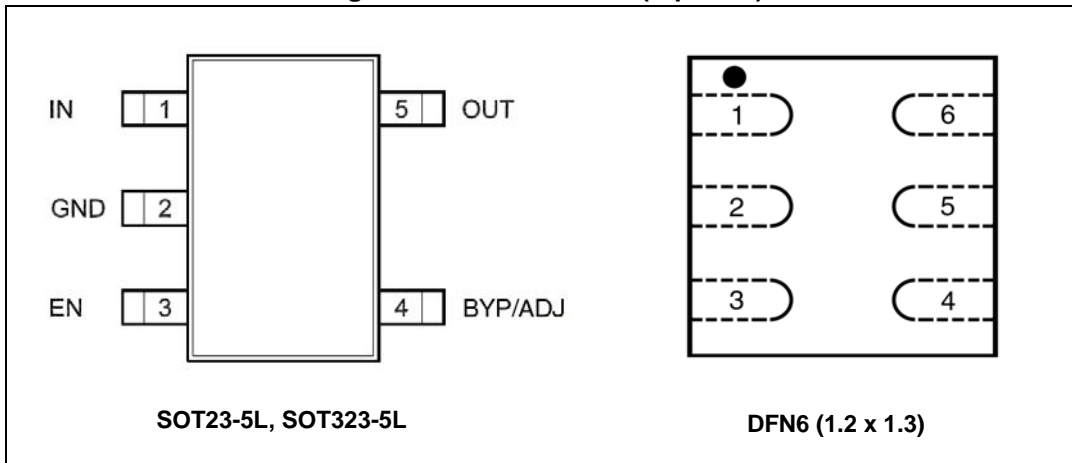

Table 1. Pin description (SOT23-5L, SOT323-5L)

Pin		Symbol	Function
SOT23/ SOT323	DFN6		
1	6	IN	Input voltage of the LDO
2	2	GND	Common ground
3	4	EN	Enable pin logic input: Low = shutdown, High = active
4	3	BYP <sup>(1)</sup> /ADJ	Bypass capacitor on fixed versions, Adjustable pin on ADJ versions
5	1	OUT	Output voltage of the LDO
-	5	N/C	Not connected. This pin should be connected to GND

1. Bypass capacitor for noise reduction on fixed version is optional, if not used the relevant pin must be left floating with no routing on the board.

### 3 Typical application

Figure 3. Typical application circuits for fixed version

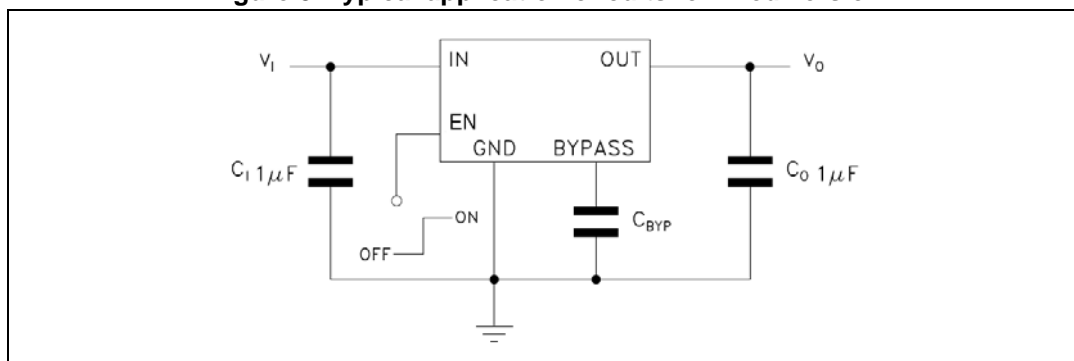
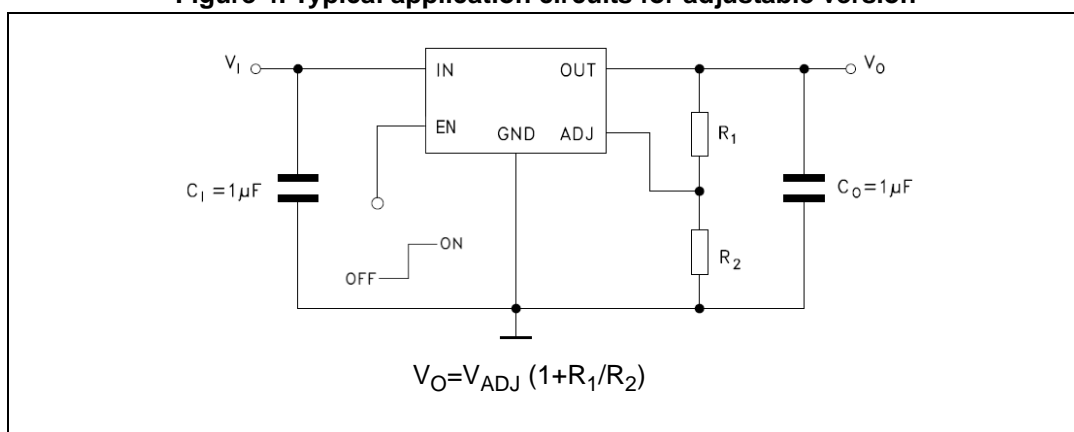

Figure 4. Typical application circuits for adjustable version



## 4 Maximum ratings

**Table 2. Absolute maximum ratings**

Symbol	Parameter	Value	Unit
$V_{IN}$	DC input voltage	- 0.3 to 7	V
$V_{OUT}$	DC output voltage	- 0.3 to $V_I + 0.3$	V
$V_{EN}$	Enable input voltage	- 0.3 to $V_I + 0.3$	V
$V_{BYP/ADJ}$	ADJ/Bypass pin voltage	2	V
$I_{OUT}$	Output current	Internally limited	mA
$P_D$	Power dissipation	Internally limited	mW
$T_{STG}$	Storage temperature range	- 65 to 150	°C
$T_{OP}$	Operating junction temperature range	- 40 to 125	°C

*Note:* Absolute maximum ratings are those values beyond which damage to the device may occur. Functional operation under these conditions is not implied. All values are referred to GND.

**Table 3. Thermal data**

Symbol	Parameter	SOT23-5L	SOT323-5L	DFN-6L	Unit
$R_{thJA}$	Thermal resistance junction-ambient	160	246	237	°C/W
$R_{thJC}$	Thermal resistance junction-case	68	134	104	°C/W



## 5 Electrical characteristics

$T_J = 25\text{ °C}$ ,  $V_{IN} = V_{OUT(NOM)} + 1\text{ V}$ ,  $C_{IN} = C_{OUT} = 1\text{ }\mu\text{F}$ ,  $I_{OUT} = 1\text{ mA}$ ,  $V_{EN} = V_{IN}$ , unless otherwise specified.

**Table 4. Electrical characteristics for LDK130 (fixed version)**

Symbol	Parameter	Test conditions	Min.	Typ.	Max.	Unit
$V_{IN}$	Operating input voltage		1.9		5.5	V
$V_{OUT}$	$V_{OUT}$ accuracy	$I_{OUT}=1\text{ mA}$ , $T_J=25\text{ °C}$	-2.0		2.0	%
		$I_{OUT}=1\text{ mA}$ , $-40\text{ °C}<T_J<125\text{ °C}$	-3.0		3.0	%
$\Delta V_{OUT}$	Static line regulation	$V_{OUT} + 1\text{ V} \leq V_{IN} \leq 5.5\text{ V}$ , $I_{OUT}=1\text{ mA}$		0.05		%/V
$\Delta V_{OUT}$	Static load regulation	$I_{OUT} = 1\text{ mA}$ to 300 mA		0.006		%/mA
$V_{DROP}$	Dropout voltage <sup>(1)</sup>	$I_{OUT} = 100\text{ mA}$ , $V_{OUT}=2.5\text{ V}$		100		mV
		$I_{OUT} = 300\text{ mA}$ , $V_{OUT}=2.5\text{ V}$ $40\text{ °C}<T_J<125\text{ °C}$		200	400	
$e_N$	Output noise voltage	10 Hz to 100 kHz, $I_{OUT}=10\text{ mA}$ , $V_{OUT}=2.5\text{ V}$ , $C_{BYP}=10\text{ nF}$		51		$\mu\text{V}_{RMS}$ /V
SVR	Supply voltage rejection	$V_{IN}=V_{OUTNOM}+0.5\text{ V}+/-V_{RIPPLE}$ $V_{RIPPLE}=0.1\text{ V}$ Freq.=120 Hz to 10 kHz $I_{OUT}=10\text{ mA}$		55		dB
$I_Q$	Quiescent current	$I_{OUT}=0\text{ mA}$ , $-40\text{ °C}<T_J<125\text{ °C}$		30	60	$\mu\text{A}$
		$I_{OUT}=300\text{ mA}$ , $-40\text{ °C}<T_J<125\text{ °C}$		70	120	
		$V_{IN}$ input current in OFF mode: $V_{EN}=GND$			1	
$I_{SC}$	Short-circuit current	$R_L=0$		450		mA
$V_{EN}$	Enable input logic low	$V_{IN}=1.9\text{ V}$ to 5.5 V, $-40\text{ °C}<T_J<125\text{ °C}$			0.4	V
	Enable input logic high	$V_{IN}=1.9\text{ V}$ to 5.5 V, $-40\text{ °C}<T_J<125\text{ °C}$	1.2			
$I_{EN}$	Enable pin input current	$V_{SHDN}=V_{IN}$			100	nA
$T_{SHDN}$	Thermal shutdown			160		$^{\circ}\text{C}$
	Hysteresis			20		
$C_{OUT}$	Output capacitor	Capacitance (see <a href="#">Section 6: Typical performance characteristics</a> )	1		22	$\mu\text{F}$

1. Dropout voltage is the input-to-output voltage difference at which the output voltage is 100 mV below its nominal value.

$T_J = 25\text{ °C}$ ,  $V_{IN} = V_{OUT(NOM)} + 1\text{ V}$ ,  $C_{IN} = C_{OUT} = 1\text{ }\mu\text{F}$ ,  $I_{OUT} = 1\text{ mA}$ ,  $V_{EN} = V_{IN}$ , unless otherwise specified.

**Table 5. Electrical characteristics for LDK130 (adjustable version)**

Symbol	Parameter	Test conditions	Min.	Typ.	Max.	Unit
$V_{IN}$	Operating input voltage		1.9		5.5	V
$V_{ADJ}$	$V_{ADJ}$ accuracy	$I_{OUT}=1\text{ mA}$ , $T_J=25\text{ °C}$	784	800	816	mV
		$I_{OUT}=1\text{ mA}$ , $-40\text{ °C}<T_J<125\text{ °C}$	-3.0		3.0	%
$\Delta V_{OUT}$	Static line regulation	$V_{OUT} + 1\text{ V} \leq V_{IN} \leq 5.5\text{ V}$ , $I_{OUT}=1\text{ mA}$		0.05		%/V
$\Delta V_{OUT}$	Static load regulation	$I_{OUT}=1\text{ mA}$ to 300 mA		0.006		%/mA
$V_{DROP}$	Dropout voltage <sup>(1)</sup>	$I_{OUT}=100\text{ mA}$ , $V_{OUT}=2.5\text{ V}$		100		mV
		$I_{OUT} = 300\text{ mA}$ , $V_{OUT}=2.5\text{ V}$ $40\text{ °C}<T_J<125\text{ °C}$ ,		200	400	
$e_N$	Output noise voltage	10 Hz to 100 kHz, $I_{OUT}=10\text{ mA}$		130		$\mu\text{V}_{RMS}/\text{V}$
$I_{ADJ}$	Adjust pin current				1	$\mu\text{A}$
SVR	Supply voltage rejection	$V_{IN}=V_{OUTNOM}+0.5\text{ V}+/-V_{RIPPLE}$ $V_{RIPPLE}=0.1\text{ V}$ Freq.=120 Hz to 10 kHz $I_{OUT}=10\text{ mA}$		55		dB
$I_Q$	Quiescent current	$I_{OUT}=0\text{ mA}$ , $-40\text{ °C}<T_J<125\text{ °C}$		30	60	$\mu\text{A}$
		$I_{OUT}=300\text{ mA}$ , $-40\text{ °C}<T_J<125\text{ °C}$		70	120	
		$V_{IN}$ input current in OFF mode: $V_{EN}=\text{GND}$			1	
$I_{SC}$	Short-circuit current	$R_L=0$		450		mA
$V_{EN}$	Enable input logic low	$V_{IN}=1.9\text{ V}$ to 5.5 V, $-40\text{ °C}<T_J<125\text{ °C}$			0.4	V
	Enable input logic high	$V_{IN}=1.9\text{ V}$ to 5.5 V, $-40\text{ °C}<T_J<125\text{ °C}$	1.2			
$I_{EN}$	Enable pin input current	$V_{SHDN}=V_{IN}$			100	nA
$T_{SHDN}$	Thermal shutdown			160		$\text{°C}$
	Hysteresis			20		
$C_{OUT}$	Output capacitor	Capacitance (see <a href="#">Section 6: Typical performance characteristics</a> )	1		22	$\mu\text{F}$

1. Dropout voltage is the input-to-output voltage difference at which the output voltage is 100 mV below its nominal value.

## 6 Typical performance characteristics

$C_{IN} = C_{OUT} = 1 \mu F$ ,  $V_{EN}$  to  $V_{IN}$ , unless otherwise specified.

**Figure 5. Output voltage vs. temp. for adjustable ( $I_O = 1 \text{ mA}$ )**

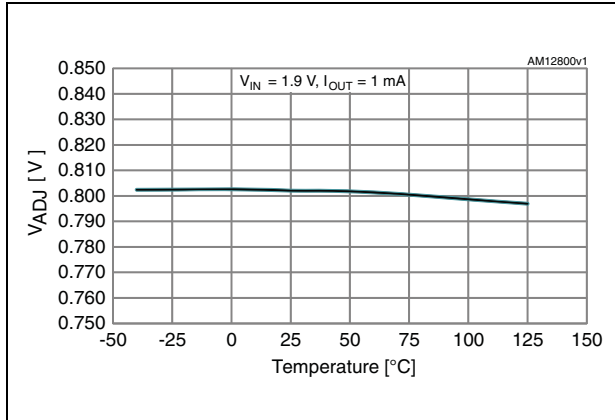

**Figure 6. Output voltage vs. temp. for adjustable version ( $I_O = 300 \text{ mA}$ )**

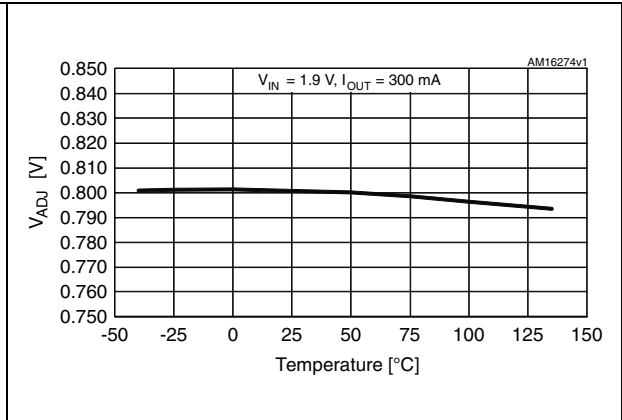

**Figure 7. Output voltage vs. temp. for fixed version ( $I_O = 1 \text{ mA}$ )**

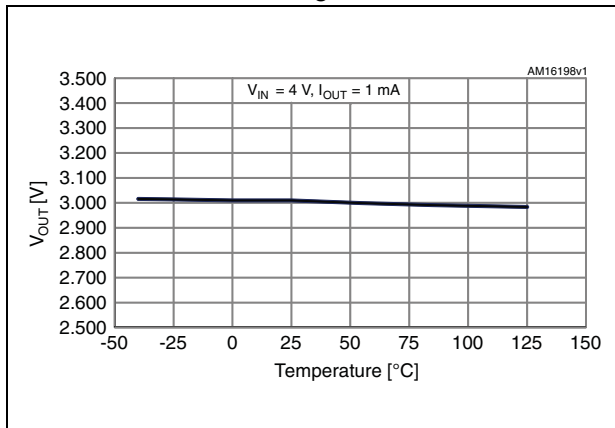

**Figure 8. Output voltage vs. temp. for fixed version ( $I_O = 300 \text{ mA}$ )**

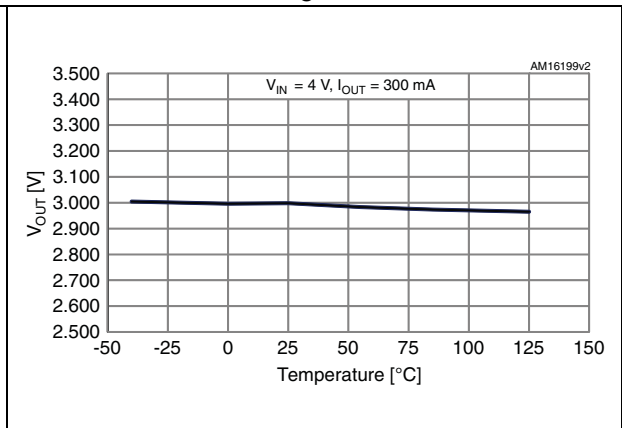

Figure 9. Line regulation vs. temp. for adjustable version

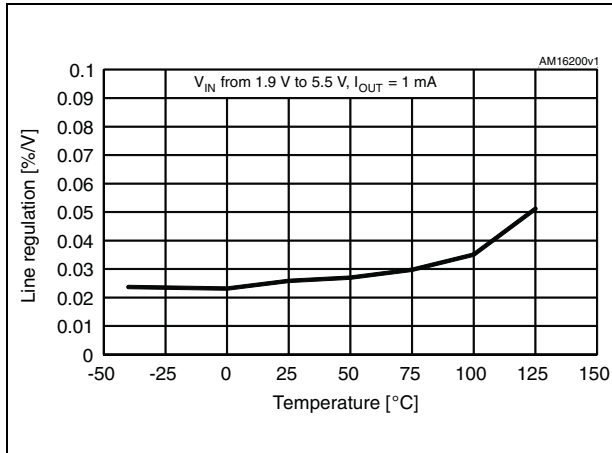

Figure 10. Short-circuit current vs. temp. for adjustable version

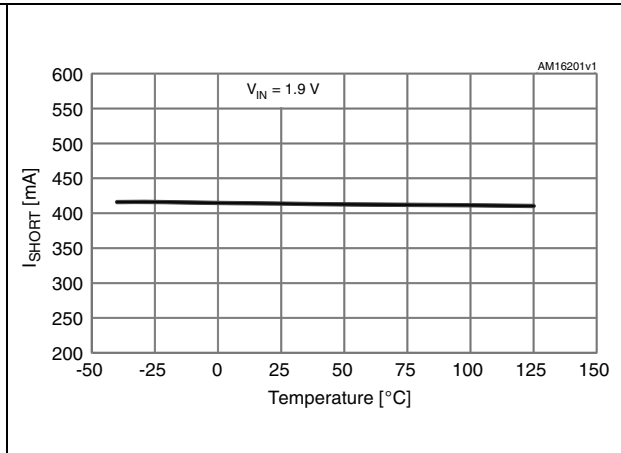

Figure 11. Load regulation vs. temp. for adjustable version

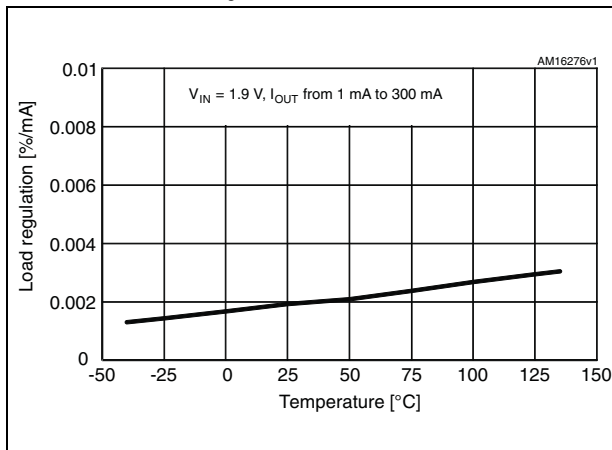

Figure 12. Load regulation vs. temp. for fixed version

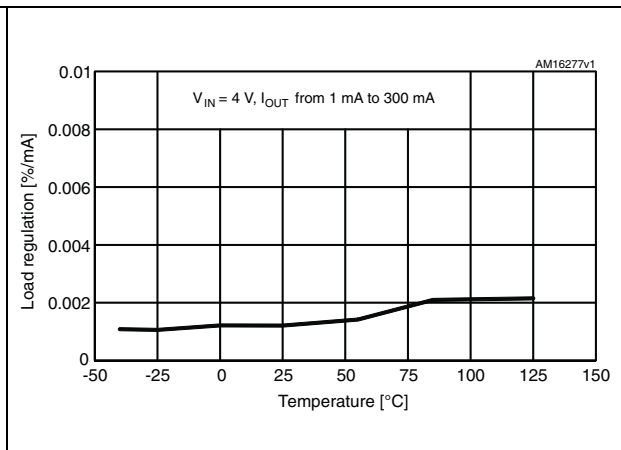

Figure 13. Enable pin thresholds vs. temp. ( $V_{IN} = 1.9$  V)

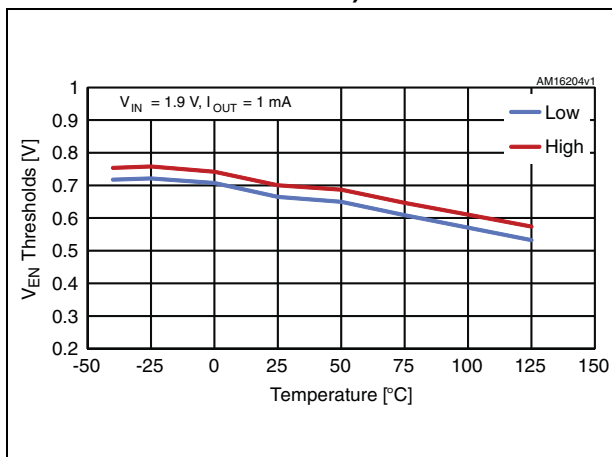

Figure 14. Enable pin thresholds vs. temp.

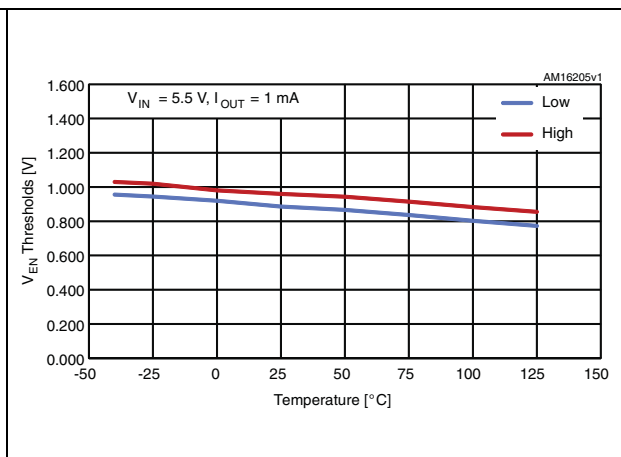

Figure 15. Quiescent current vs. temp. for adjustable version ( $I_O = 0$  mA)

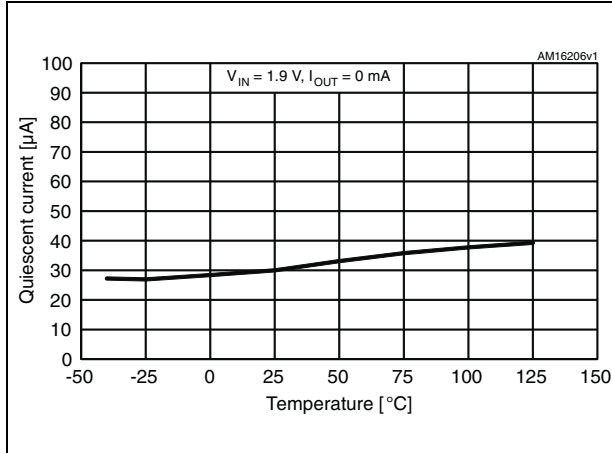

Figure 16. Quiescent current vs. temp. for adjustable version ( $I_O = 300$  mA)

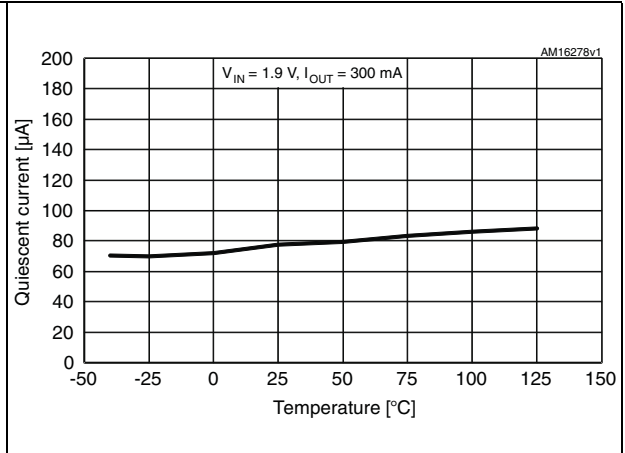

Figure 17. Quiescent current vs. temp. for fixed version ( $I_O = 0$  mA)

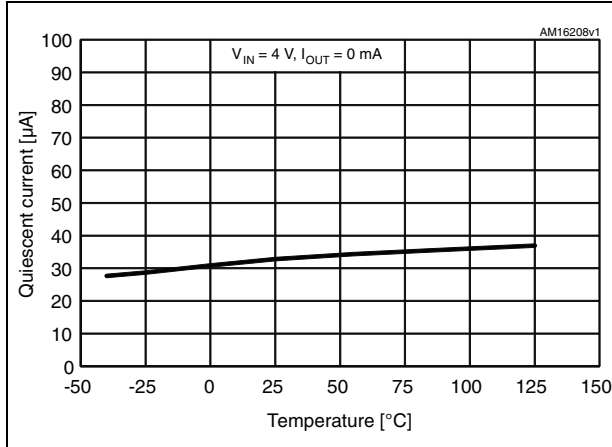

Figure 18. Quiescent current vs. temp. for fixed version ( $I_O = 300$  mA)

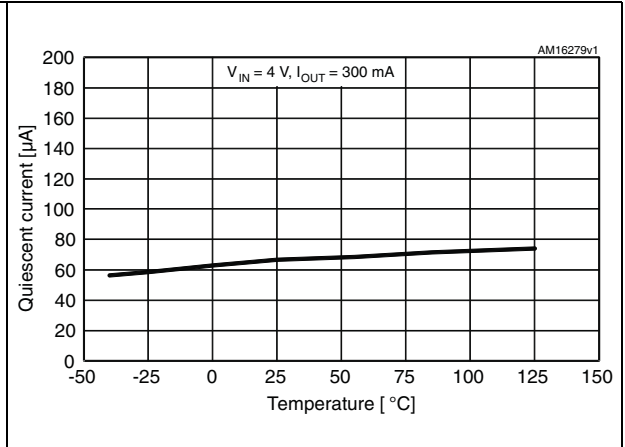

Figure 19. Shutdown current vs. temperature

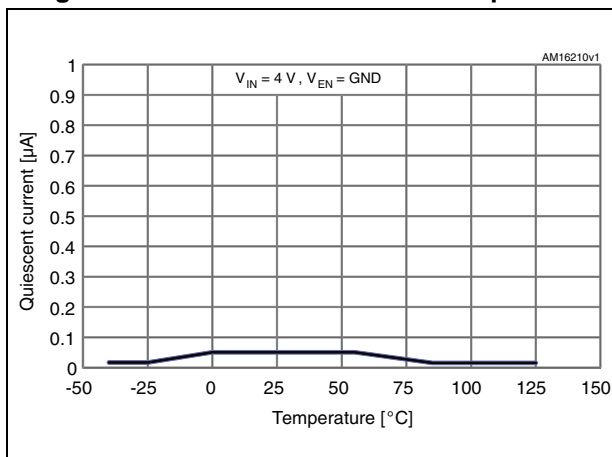

Figure 20. SVR vs. frequency ( $V_O = 2.5$  V)

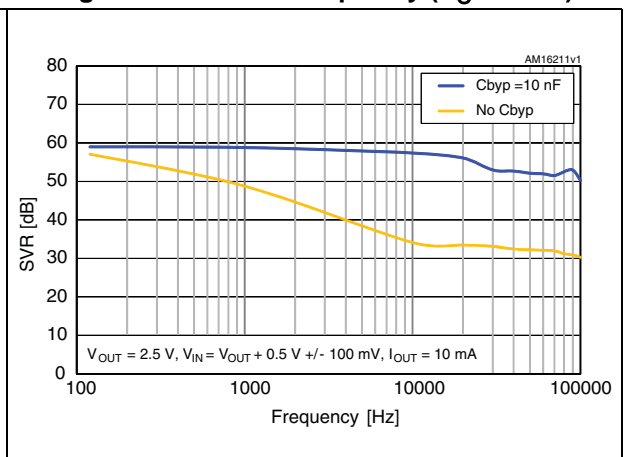

Figure 21. SVR vs. frequency ( $V_O = V_{ADJ}$ )

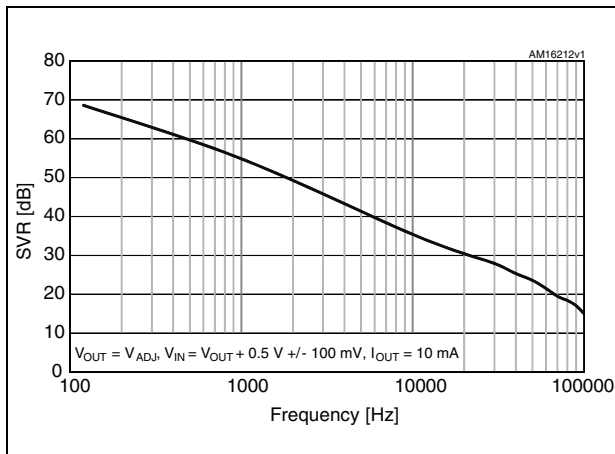

Figure 22. Output noise vs. frequency ( $V_O = 3.3\text{ V}$ )

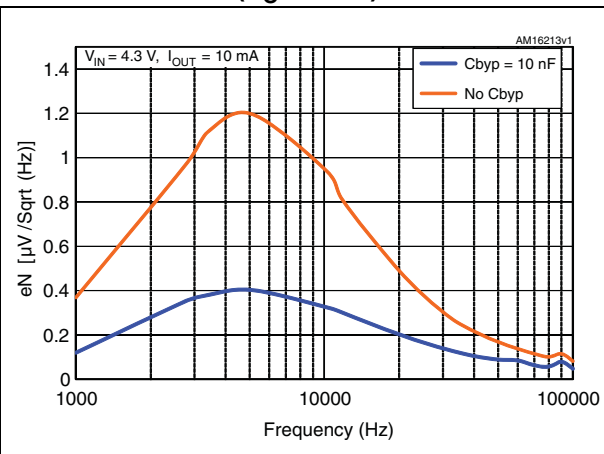

Figure 23. Output noise vs. frequency ( $V_O = V_{ADJ}$ )

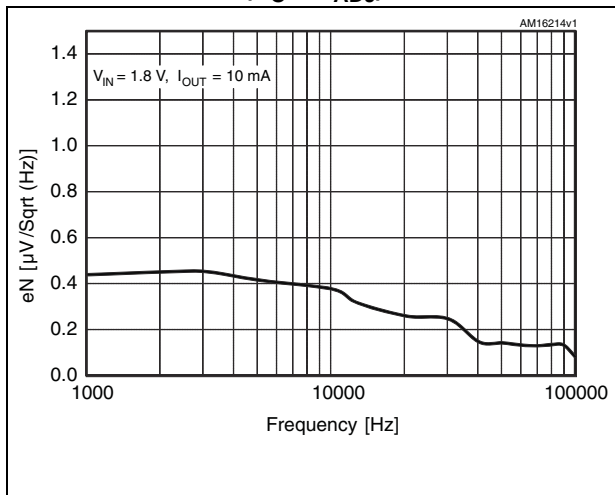

Figure 24. Stability region vs.  $C_{OUT}$  (fixed)

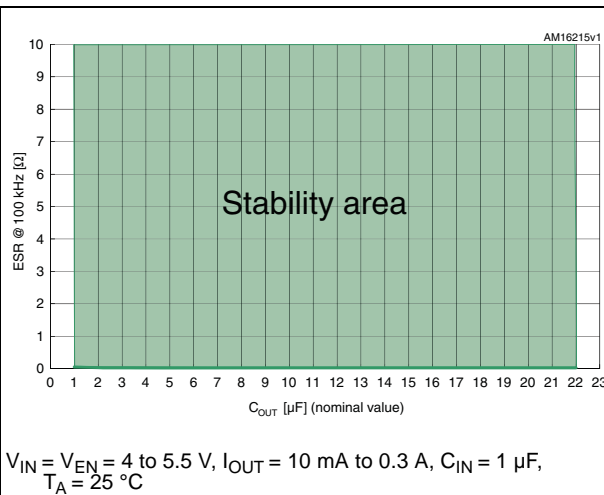

Figure 25. Stability region vs  $C_{OUT}$  (adjust.)

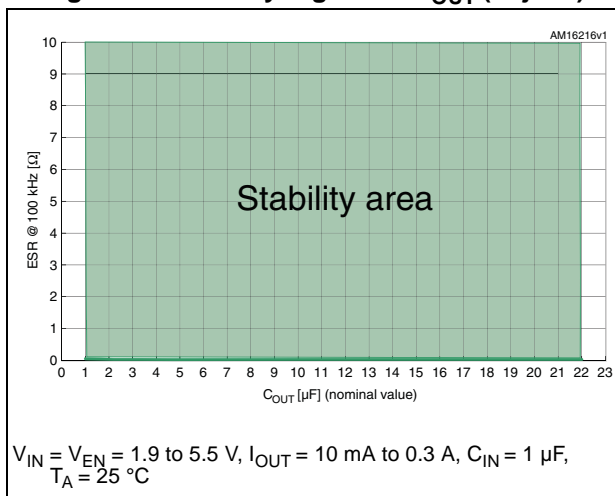

Figure 26. Line transient ( $V_{OUT} = V_{ADJ}$ )

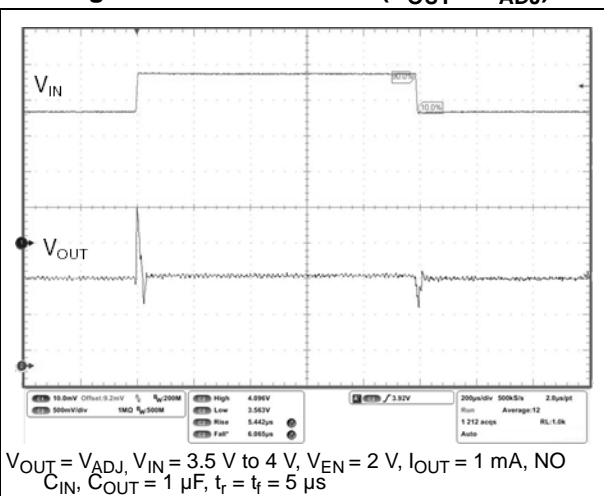
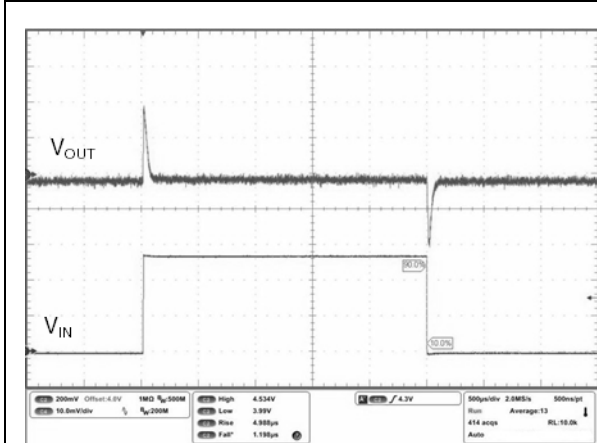
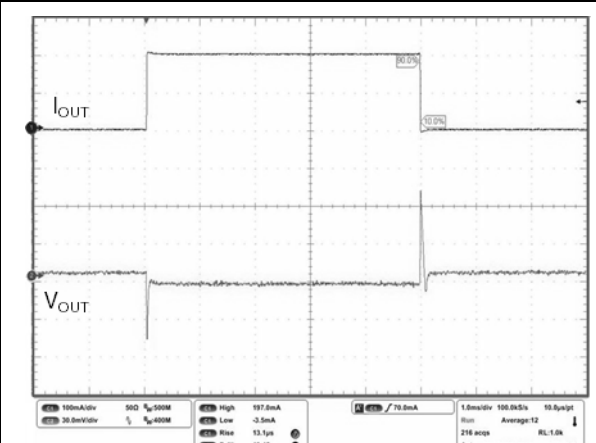

Figure 27. Line transient ( $V_{OUT} = 3\text{ V}$ )



$V_{OUT} = 3\text{ V}$ ,  $V_{IN} = 4\text{ V}$  to  $4.5\text{ V}$ ,  $V_{EN} = 2\text{ V}$ ,  $I_{OUT} = 1\text{ mA}$ , NO  $C_{IN}$ ,  $C_{OUT} = 1\text{ }\mu\text{F}$ ,  $t_r = t_f = 5\text{ }\mu\text{s}$

Figure 28. Load transient ( $V_{OUT} = 3\text{ V}$ )



$V_{OUT} = 3\text{ V}$ ,  $V_{IN} = V_{EN} = 3.5\text{ V}$ ,  $I_{OUT} = 1\text{ mA}$  to  $200\text{ mA}$ ,  $C_{OUT} = 1\text{ }\mu\text{F}$ ,  $t_r = t_f = 5\text{ }\mu\text{s}$

Figure 29. Load transient ( $V_{OUT} = V_{ADJ}$ )

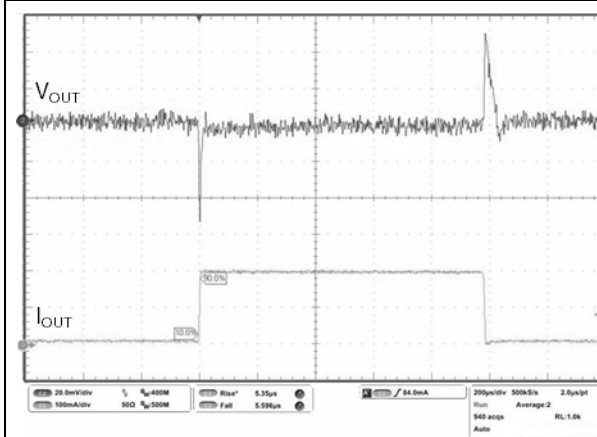

$V_{OUT} = V_{ADJ}$ ,  $V_{IN} = V_{EN} = 3.5\text{ V}$ ,  $I_{OUT} = 1\text{ mA}$  to  $200\text{ mA}$ ,  $C_{OUT} = 1\text{ }\mu\text{F}$ ,  $t_r = t_f = 5\text{ }\mu\text{s}$

Figure 30. Startup transient

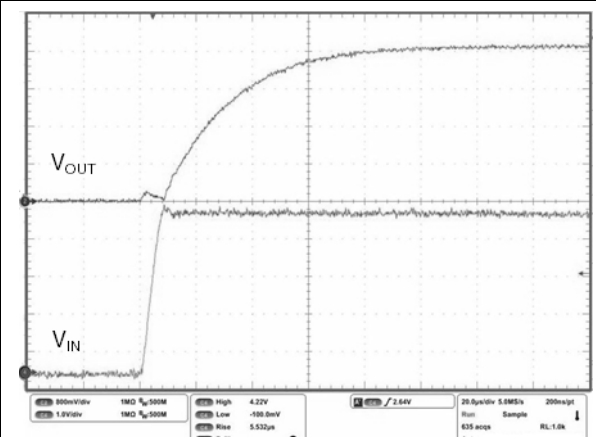

$V_{OUT} = 3\text{ V}$ ,  $V_{IN} = V_{EN} = 0$  to  $4.2\text{ V}$ ,  $I_{OUT} = 1\text{ mA}$ ,  $C_{IN} = C_{OUT} = 1\text{ }\mu\text{F}$ ,  $t_r = t_f = 5\text{ }\mu\text{s}$

Figure 31. Enable transient ( $V_{OUT} = V_{ADJ}$ )

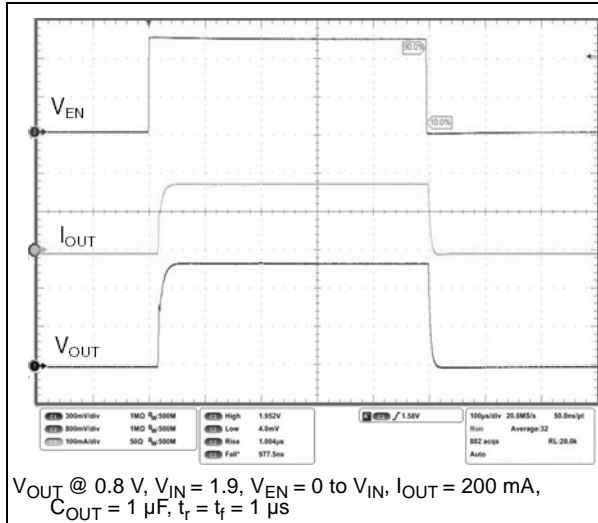

Figure 32. Enable transient ( $V_{OUT} = 3$  V)

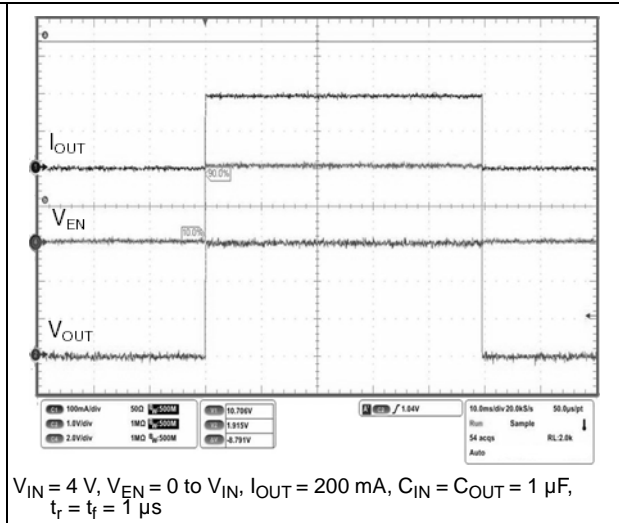

Figure 33. Dropout voltage vs. temperature ( $I_{OUT} = 100$  mA)

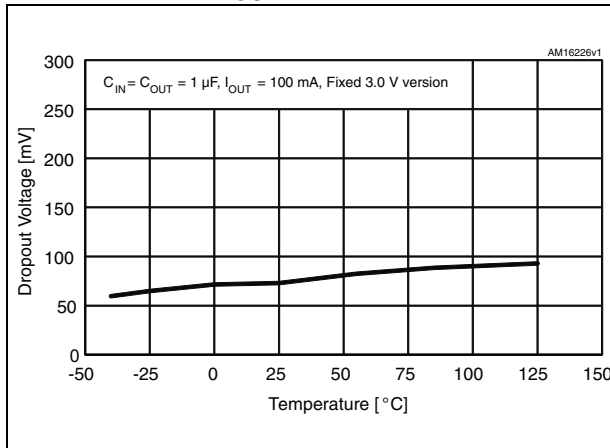
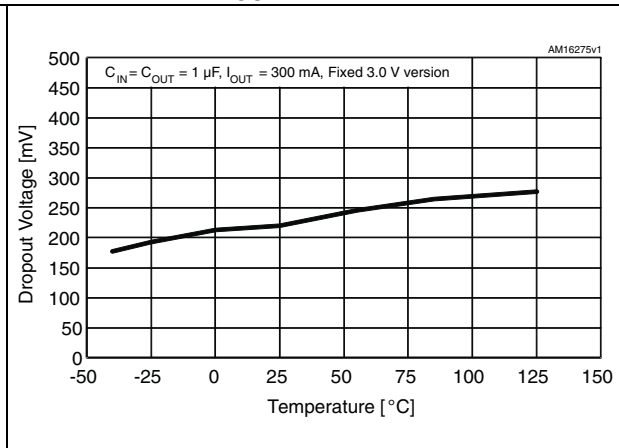

Figure 34. Dropout voltage vs. temperature ( $I_{OUT} = 300$  mA)





## 7 Package mechanical data

In order to meet environmental requirements, ST offers these devices in different grades of ECOPACK<sup>®</sup> packages, depending on their level of environmental compliance. ECOPACK specifications, grade definitions and product status are available at: [www.st.com](http://www.st.com). ECOPACK is an ST trademark.

Figure 35. SOT23-5L mechanical drawing

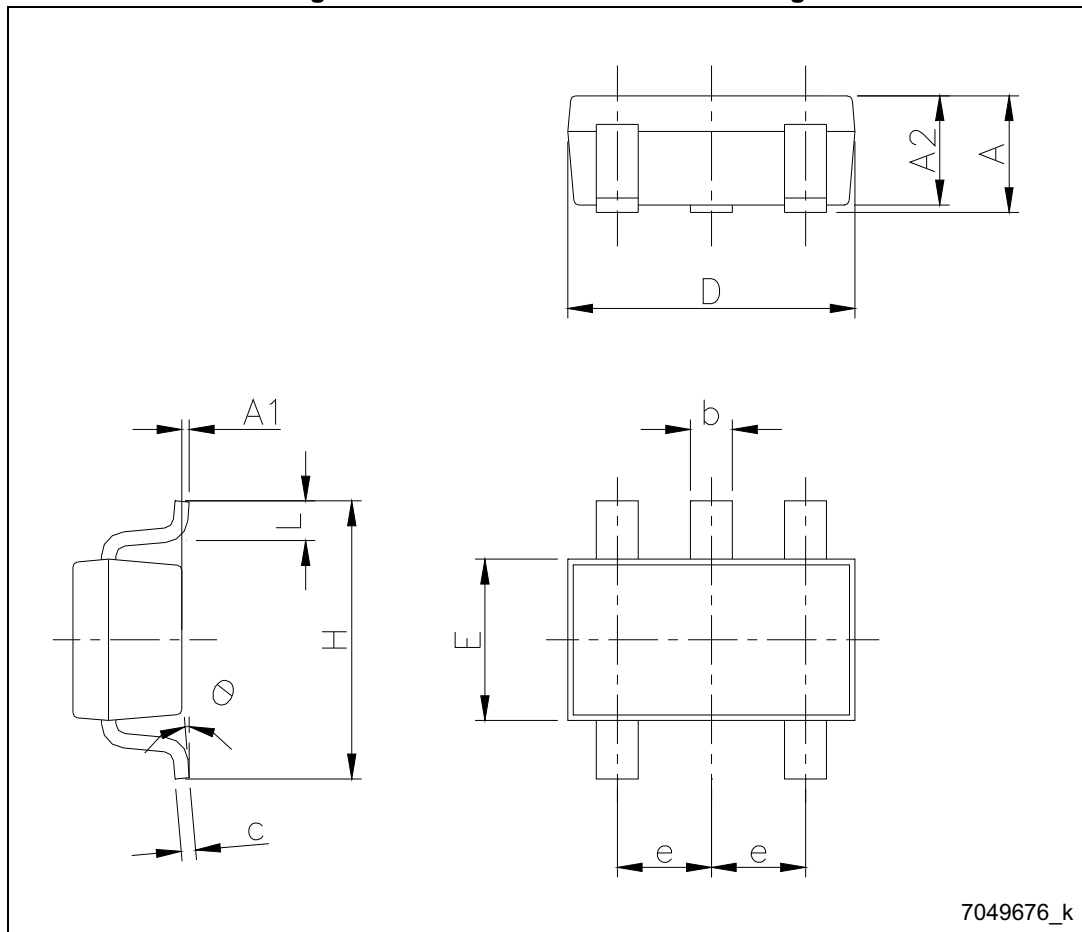

Table 6. SOT23-5L mechanical data

Dim.	mm		
	Min.	Typ.	Max.
A	0.90		1.45
A1	0		0.15
A2	0.90		1.30
b	0.30		0.50
c	2.09		0.20
D		2.95	
E		1.60	
e		0.95	
H		2.80	
L	0.30		0.60
$\theta$	0		8

Figure 36. SOT23-5L footprint (dimensions in mm)

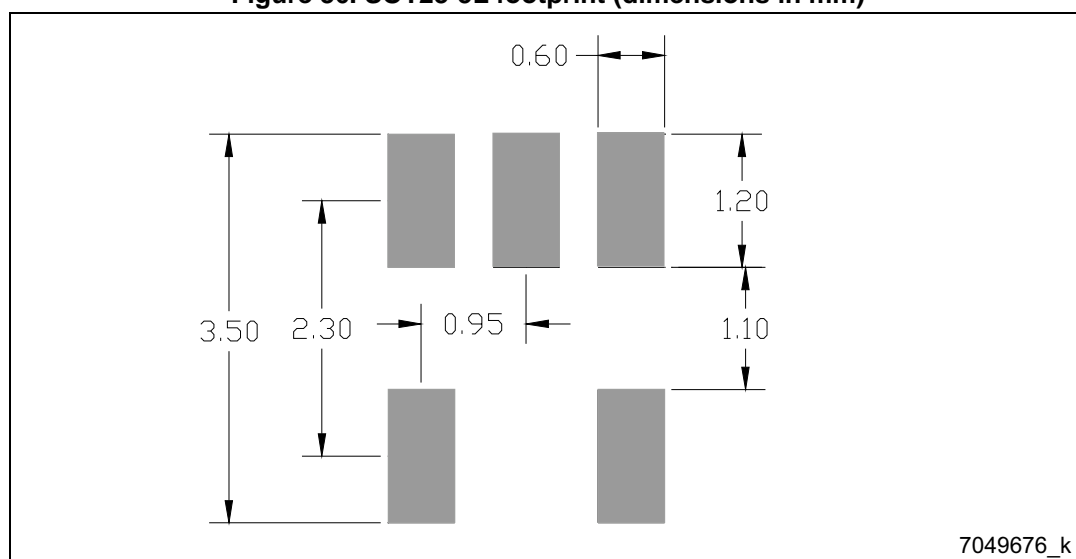
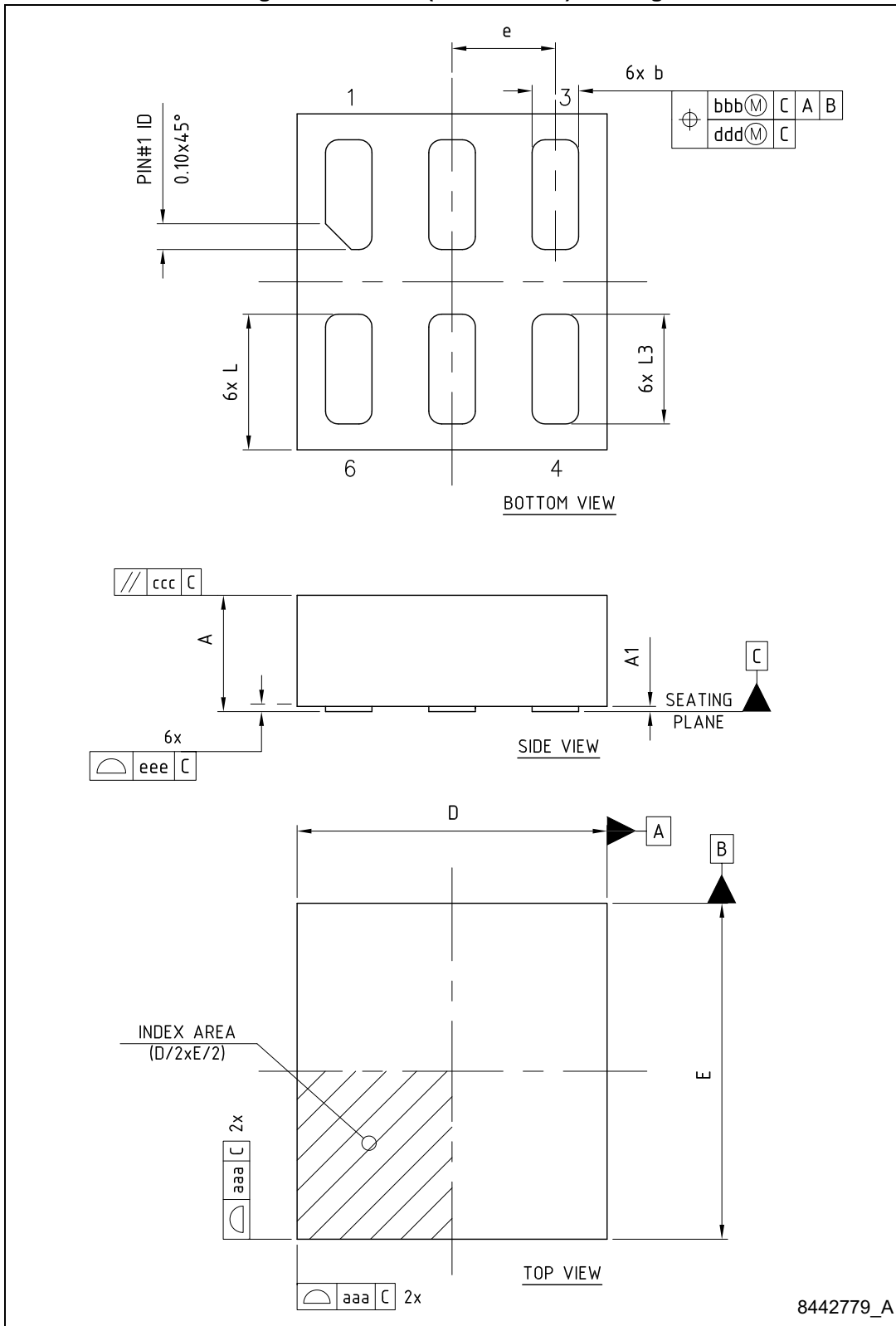

Figure 37. DFN6L (1.2 x 1.3 mm) drawing



8442779\_A

Table 7. DFN6L (1.2 x 1.3 mm) mechanical data

Dim.	mm		
	Min.	Typ.	Max.
A	0.41	0.45	0.50
A1	0.00	0.02	0.05
D	-	1.20	-
E	-	1.30	-
e	-	0.40	-
b	0.15	0.18	0.25
L	0.475	0.525	0.575
L3	0.375	0.425	0.475
aaa	-	0.05	-

Figure 38. DFN6L footprint (dimensions in mm)

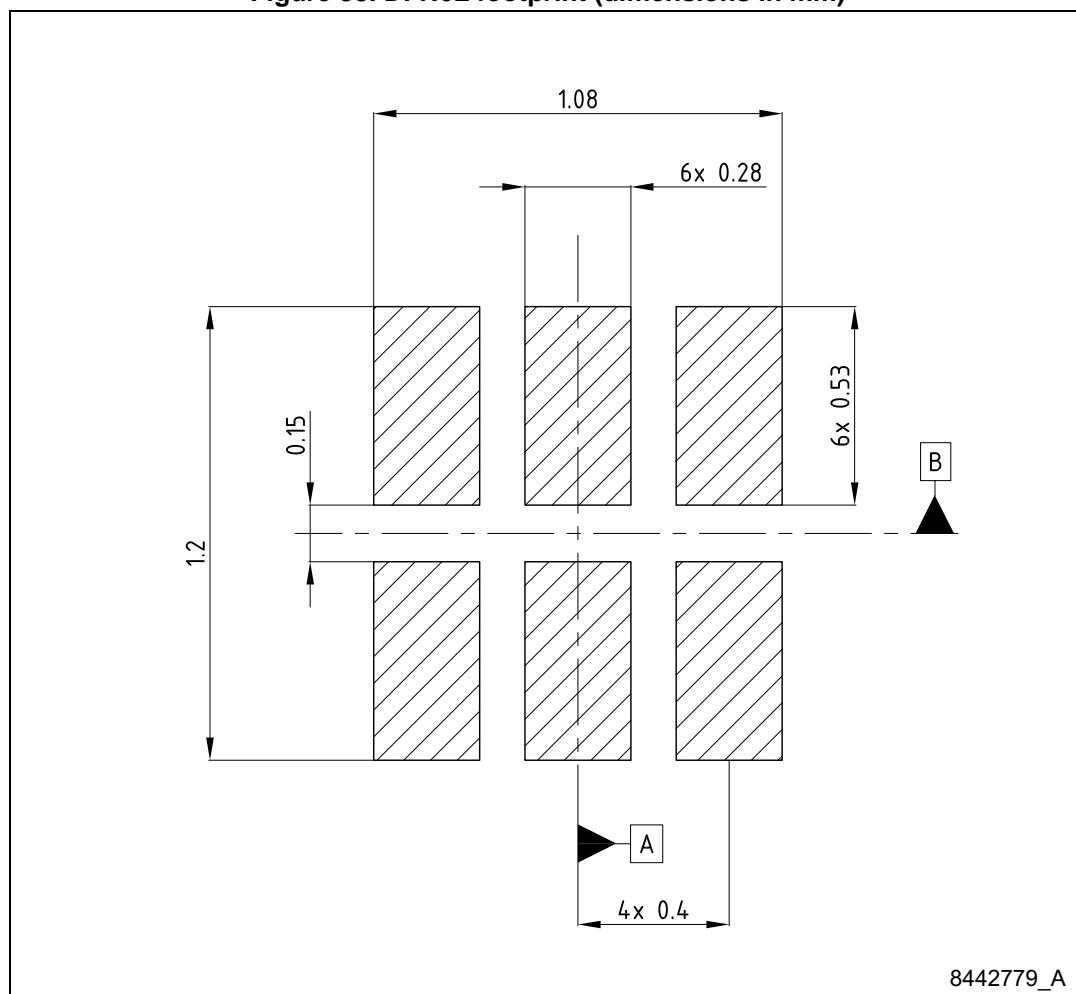

Figure 39. SOT323-5L drawing

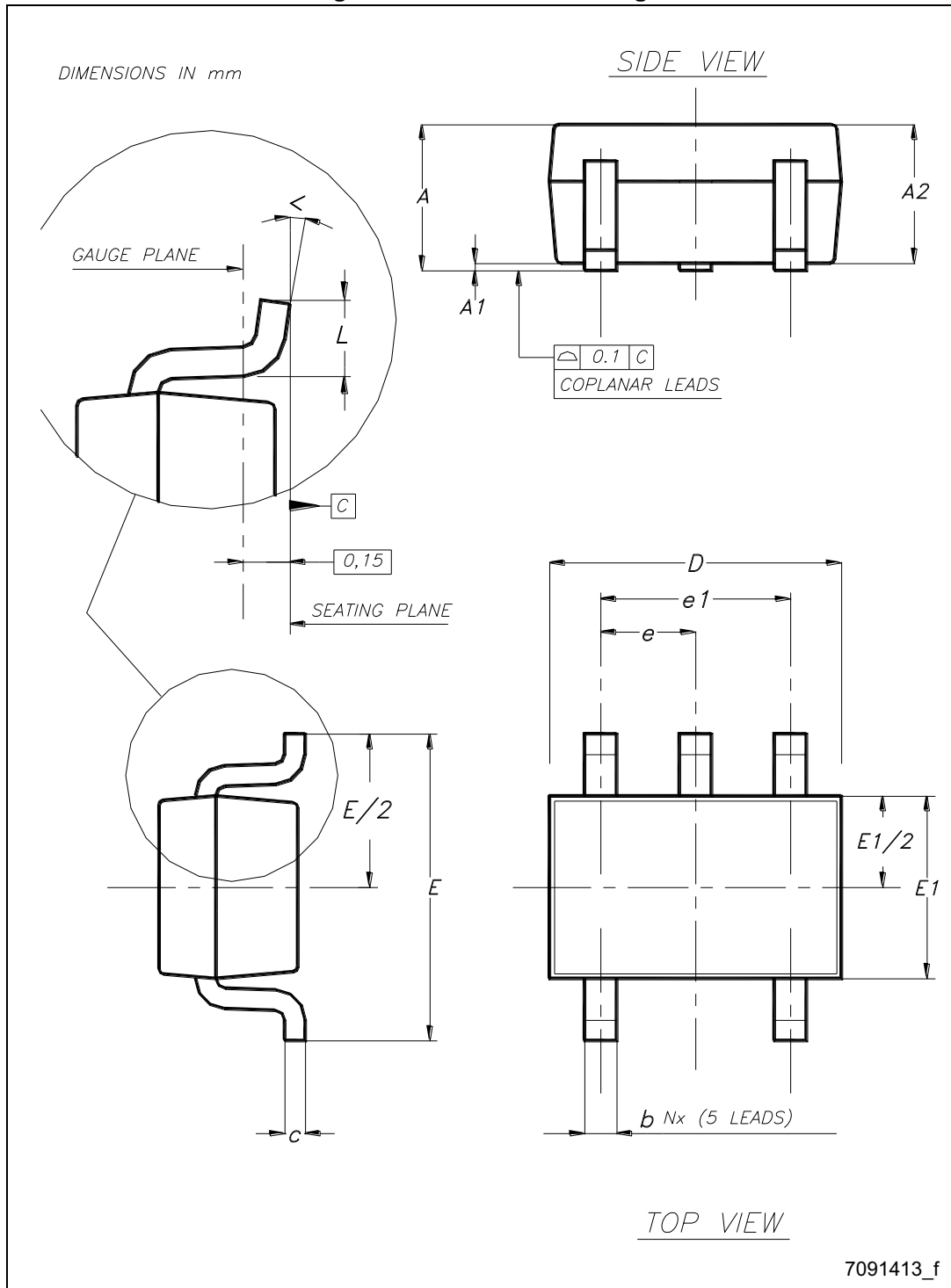

Table 8. SOT323-5L mechanical data

Dim.	mm		
	Min.	Typ.	Max.
A	0.80		1.10
A1	0		0.10
A2	0.80	0.90	1
b	0.15		0.30
c	0.10		0.22
D	1.80	2	2.20
E	1.80	2.10	2.40
E1	1.15	1.25	1.35
e		0.65	
e1		1.30	
L	0.26	0.36	0.46
<	0°		8°

## 8 Packaging mechanical data

Figure 40. TSOT23-5L and SOT323-xL tape and reel drawing

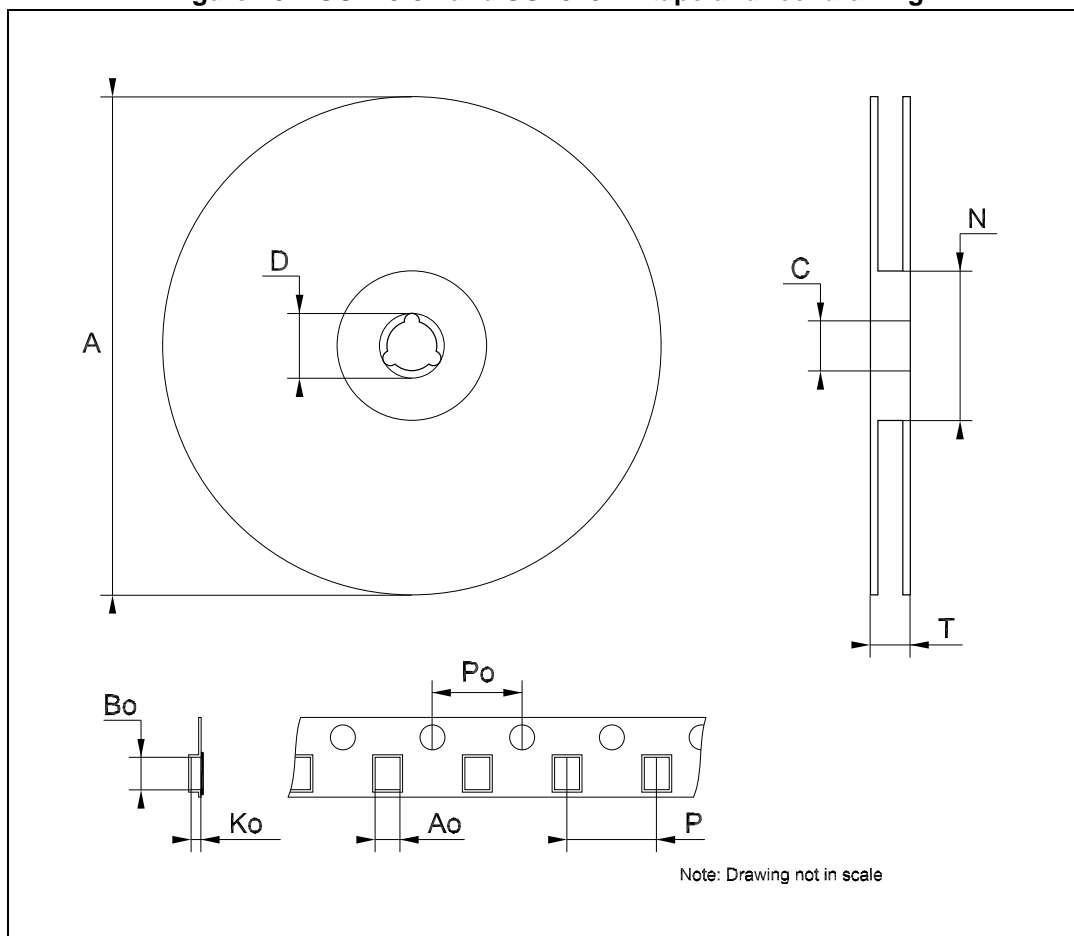

Table 9. SOT23-5L tape and reel mechanical data

Dim.	mm		
	Min.	Typ.	Max.
A			180
C	12.8	13.0	13.2
D	20.2		
N	60		
T			14.4
Ao	3.13	3.23	3.33
Bo	3.07	3.17	3.27
Ko	1.27	1.37	1.47
Po	3.9	4.0	4.1
P	3.9	4.0	4.1

Table 10. SOT323-xL tape and reel mechanical data

Dim.	mm		
	Min.	Typ.	Max.
A	175	180	185
C	12.8	13	13.2
D	20.2		
N	59.5	60	60.5
T			14.4
Ao		2.25	
Bo		3.17	
Ko		1.2	
Po	3.9	4.0	4.1
P	3.9	4.0	4.2



## 9 Order codes

**Table 11. Order codes**

Packages			Output voltages
SOT323-5L	SOT23-5L	DFN6L	
LDK130C-R	LDK130M-R	LDK130PU-R	ADJ
LDK130C08R	LDK130M08R	LDK130PU08R	0.8 V
LDK130C10R	LDK130M10R	LDK130PU10R	1 V
LDK130C12R	LDK130M12R	LDK130PU12R	1.2 V
LDK130C15R	LDK130M15R	LDK130PU15R	1.5 V
LDK130C18R	LDK130M18R	LDK130PU18R	1.8 V
	LDK130M25R	LDK130PU25R	2.5 V
LDK130C29R	LDK130M29R	LDK130PU29R	2.9 V
		LDK130PU30R	3 V
LDK130C32R	LDK130M32R	LDK130PU32R	3.2 V
LDK130C33R	LDK130M33R	LDK130PU33R	3.3 V

**Table 12. Marking**

Order codes	Packages	Output voltages	Marking
LDK130MxxR	SOT23-5L	xx V	Kxx
LDK130CxxR	SOT323-5L	xx V	Kxx
LDK130PUxxR	DFN-6L	xx V	xx
LDK130M-R	SOT23-5L	Adj	KAD
LDK130C-R	SOT323-5L	Adj	KAD
LDK130PU-R	DFN-6L	Adj	AD

## 10 Revision history

**Table 13. Document revision history**

Date	Revision	Changes
31-Jan-2013	1	Initial release
25-Oct-2013	2	RPN LDK130xx changed to LDK130. Updated the Features and the Description in cover page. Cancelled Table1: Device summary. Updated <a href="#">Section 7: Package mechanical data</a> , <a href="#">Table 2: Absolute maximum ratings</a> and <a href="#">Table 11: Order codes</a> . Added <a href="#">Section 8: Packaging mechanical data</a> . Minor text changes.
10-Mar-2014	3	Updated <a href="#">Table 11: Order codes</a> .

**Please Read Carefully:**

Information in this document is provided solely in connection with ST products. STMicroelectronics NV and its subsidiaries ("ST") reserve the right to make changes, corrections, modifications or improvements, to this document, and the products and services described herein at any time, without notice.

All ST products are sold pursuant to ST's terms and conditions of sale.

Purchasers are solely responsible for the choice, selection and use of the ST products and services described herein, and ST assumes no liability whatsoever relating to the choice, selection or use of the ST products and services described herein.

No license, express or implied, by estoppel or otherwise, to any intellectual property rights is granted under this document. If any part of this document refers to any third party products or services it shall not be deemed a license grant by ST for the use of such third party products or services, or any intellectual property contained therein or considered as a warranty covering the use in any manner whatsoever of such third party products or services or any intellectual property contained therein.

**UNLESS OTHERWISE SET FORTH IN ST'S TERMS AND CONDITIONS OF SALE ST DISCLAIMS ANY EXPRESS OR IMPLIED WARRANTY WITH RESPECT TO THE USE AND/OR SALE OF ST PRODUCTS INCLUDING WITHOUT LIMITATION IMPLIED WARRANTIES OF MERCHANTABILITY, FITNESS FOR A PARTICULAR PURPOSE (AND THEIR EQUIVALENTS UNDER THE LAWS OF ANY JURISDICTION), OR INFRINGEMENT OF ANY PATENT, COPYRIGHT OR OTHER INTELLECTUAL PROPERTY RIGHT.**

**ST PRODUCTS ARE NOT DESIGNED OR AUTHORIZED FOR USE IN: (A) SAFETY CRITICAL APPLICATIONS SUCH AS LIFE SUPPORTING, ACTIVE IMPLANTED DEVICES OR SYSTEMS WITH PRODUCT FUNCTIONAL SAFETY REQUIREMENTS; (B) AERONAUTIC APPLICATIONS; (C) AUTOMOTIVE APPLICATIONS OR ENVIRONMENTS, AND/OR (D) AEROSPACE APPLICATIONS OR ENVIRONMENTS. WHERE ST PRODUCTS ARE NOT DESIGNED FOR SUCH USE, THE PURCHASER SHALL USE PRODUCTS AT PURCHASER'S SOLE RISK, EVEN IF ST HAS BEEN INFORMED IN WRITING OF SUCH USAGE, UNLESS A PRODUCT IS EXPRESSLY DESIGNATED BY ST AS BEING INTENDED FOR "AUTOMOTIVE, AUTOMOTIVE SAFETY OR MEDICAL" INDUSTRY DOMAINS ACCORDING TO ST PRODUCT DESIGN SPECIFICATIONS. PRODUCTS FORMALLY ESCC, QML OR JAN QUALIFIED ARE DEEMED SUITABLE FOR USE IN AEROSPACE BY THE CORRESPONDING GOVERNMENTAL AGENCY.**

Resale of ST products with provisions different from the statements and/or technical features set forth in this document shall immediately void any warranty granted by ST for the ST product or service described herein and shall not create or extend in any manner whatsoever, any liability of ST.

ST and the ST logo are trademarks or registered trademarks of ST in various countries.

Information in this document supersedes and replaces all information previously supplied.

The ST logo is a registered trademark of STMicroelectronics. All other names are the property of their respective owners.

© 2014 STMicroelectronics - All rights reserved

STMicroelectronics group of companies

Australia - Belgium - Brazil - Canada - China - Czech Republic - Finland - France - Germany - Hong Kong - India - Israel - Italy - Japan - Malaysia - Malta - Morocco - Philippines - Singapore - Spain - Sweden - Switzerland - United Kingdom - United States of America

[www.st.com](http://www.st.com)