

Target Applications

- Wireless charging
- Adapter
- Telecom

Benefits

- Higher power density designs
- Higher switching frequency
- IR MOSFET — Uses OptiMOS™5 Chip
- Reduced parts count wherever 5V supplies are available
- Driven directly from microcontrollers (slow switching)
- System cost reductions

Typical values (unless otherwise specified)

V_{DS}	V_{GS}	$R_{DS(on)}$ (max.)
80V min.	± 20V max	32mΩ @ 10V
$Q_{g\ tot}$	Q_{gd}	$V_{gs(th)}$
4.7nC	1.8nC	1.7V

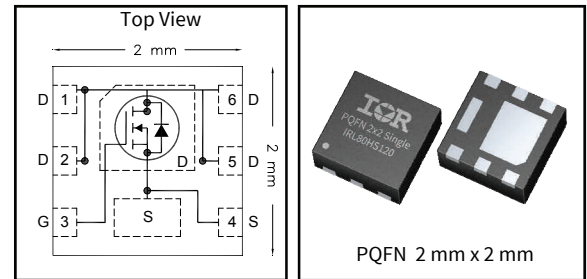

G	D	S
Gate	Drain	Source

Base part number	Package Type	Standard Pack		Orderable Part Number
		Form	Quantity	
IRL80HS120	PQFN 2mm x 2mm	Tape and Reel	4000	IRL80HS120

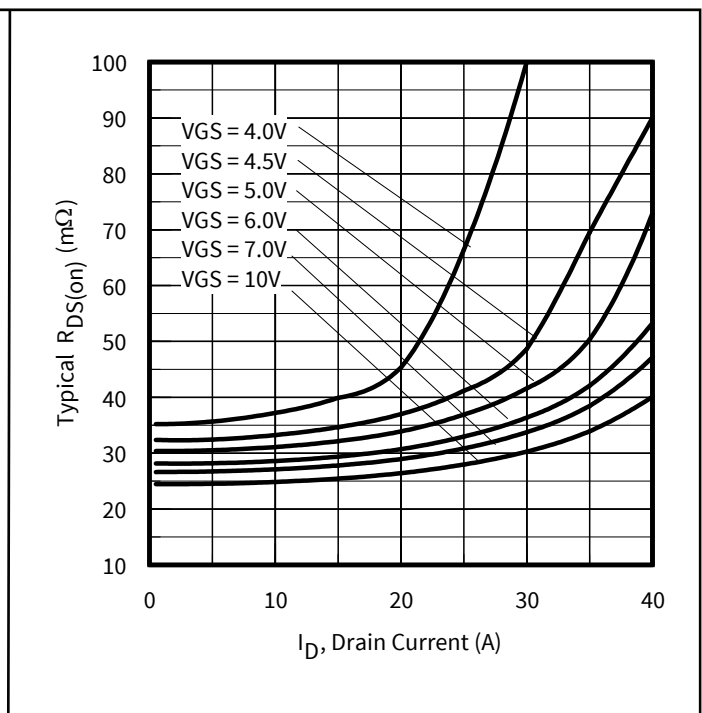
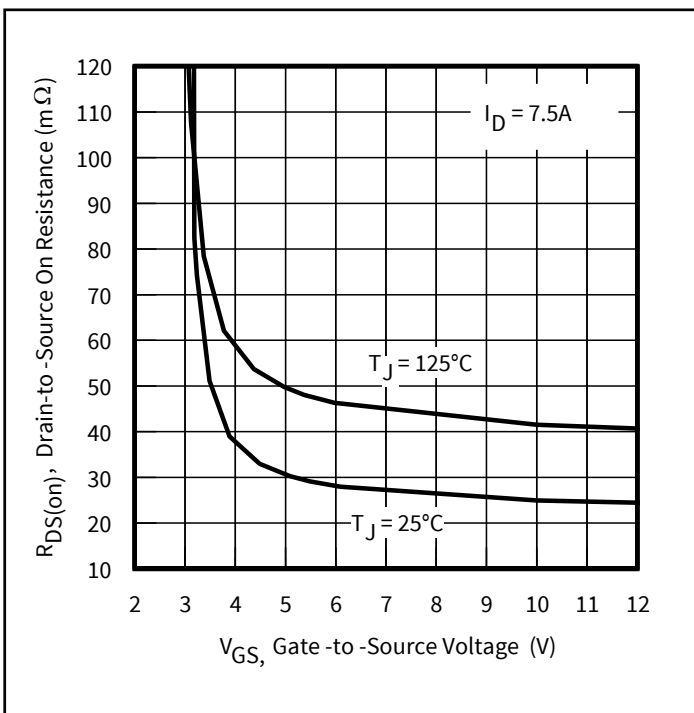

Figure 1 Typical On-Resistance vs. Gate Voltage

Figure 2 Typical On-Resistance vs. Drain Current

Table of Contents

Target Applications1

Benefits1

Ordering Table1

Table of Contents2

1 Parameters3

2 Maximum ratings, Thermal, and Avalanche characteristics4

3 Electrical characteristics5

4 Electrical characteristic diagrams6

Package Information12

Qualification Information14

Revision History15

1 Parameters

Table1 Key performance parameters

Parameter	Values	Units
V_{DS}	80	V
$R_{DS(on) max}$	32	m Ω
$I_D @ T_C = 25^\circ C$	12.5	A
$I_D @ T_A = 25^\circ C$	6.0	A

2 Maximum ratings and thermal characteristics

Table 2 Maximum ratings (at $T_J = 25^\circ\text{C}$, unless otherwise specified)

Parameter	Symbol	Conditions	Values	Unit
Continuous Drain Current (Silicon Limited) ⑥ ⑦	I_D	$T_{C(\text{Bottom})} = 25^\circ\text{C}, V_{GS} @ 10\text{V}$	12.5	A
Continuous Drain Current (Silicon Limited) ⑥	I_D	$T_{C(\text{Bottom})} = 100^\circ\text{C}, V_{GS} @ 10\text{V}$	9.0	
Continuous Drain Current (Silicon Limited) ⑦ (Source Bonding Technologies Limited)	I_D	$T_{C(\text{Bottom})} = 25^\circ\text{C}, V_{GS} @ 10\text{V}$	10.2	
Continuous Drain Current (Silicon Limited) ⑤	I_D	$T_A = 25^\circ\text{C}, V_{GS} @ 10\text{V}$	6.0	
Pulsed Drain Current ①	I_{DM}	$T_{C(\text{Bottom})} = 25^\circ\text{C}$	41	W
Maximum Power Dissipation	P_D	$T_{C(\text{Bottom})} = 25^\circ\text{C}$	11.5	
Maximum Power Dissipation	P_D	$T_{C(\text{Bottom})} = 100^\circ\text{C}$	5.8	
Maximum Power Dissipation	P_D	$T_A = 25^\circ\text{C}$	2.5	V
Gate-to-Source Voltage	V_{GS}	-	± 20	
Peak Soldering Temperature	T_P	-	270	$^\circ\text{C}$
Operating Junction and Storage Temperature Range	T_J, T_{STG}	-	-55 to + 175	

Table 3 Thermal characteristics

Parameter	Symbol	Conditions	Min.	Typ.	Max.	Unit
Junction-to-Case (Bottom) ④	$R_{\theta JC}$	-	-	-	13	$^\circ\text{C}/\text{W}$
Junction-to-Case (Top) ④	$R_{\theta JC}$	-	-	-	90	
Junction-to-Ambient ⑤	$R_{\theta JA}$	-	-	-	60	
Junction-to-Ambient ⑤	$R_{\theta JA} (<10\text{s})$	-	-	-	42	

Table 4 Avalanche characteristics

Parameter	Symbol	Values	Unit
Single Pulse Avalanche Energy ②	E_{AS}	22	mJ
Avalanche Current ②	I_{AR}	7.5	A

Notes:

- ① Repetitive rating; pulse width limited by max. junction temperature.
- ② Starting $T_J = 25^\circ\text{C}$, $L = 0.8\text{mH}$, $R_G = 50\Omega$, $I_{AS} = 7.5\text{A}$.
- ③ Pulse width $\leq 400\mu\text{s}$; duty cycle $\leq 2\%$.
- ④ R_θ is measured at T_J of approximately 90°C .
- ⑤ When mounted on a 1 inch square PCB (FR-4). Please refer to AN-994 for more details.
- ⑥ Calculated continuous current based on maximum allowable junction temperature.
- ⑦ Current is limited to 10.2A by source bonding technology.

3 Electrical characteristics

Table 5 Static characteristics

Parameter	Symbol	Conditions	Values			Unit
			Min.	Typ.	Max.	
Drain-to-Source Breakdown Voltage	$V_{(BR)DSS}$	$V_{GS} = 0V, I_D = 250\mu A$	80	-	-	V
Breakdown Voltage Temp. Coefficient	$\Delta V_{(BR)DSS}/\Delta T_J$	Reference to 25°C, $I_D = 1mA$	-	38	-	mV/°C
Static Drain-to-Source On-Resistance	$R_{DS(on)}$	$V_{GS} = 10V, I_D = 7.5A$ ③	-	25	32	mΩ
		$V_{GS} = 4.5V, I_D = 3.8A$ ③	-	32	42	
Gate Threshold Voltage	$V_{GS(th)}$	$V_{DS} = V_{GS}, I_D = 10\mu A$	1.1	1.7	2.3	V
Gate Threshold Voltage Temp. Coefficient	$\Delta V_{GS(th)}/\Delta T_J$		-	-6.4	-	mV°/C
Drain-to-Source Leakage Current	I_{DSS}	$V_{DS} = 64V, V_{GS} = 0V$	-	-	1.0	μA
Gate-to-Source Forward Leakage	I_{GSS}	$V_{GS} = 20V$	-	-	100	nA
	I_{GSS}	$V_{GS} = -20V$	-	-	100	
Gate Resistance	R_G	-	-	1.1	-	Ω

Table 6 Dynamic characteristics

Parameter	Symbol	Conditions	Values			Unit
			Min.	Typ.	Max.	
Forward Trans conductance	gfs	$V_{DS} = 10V, I_D = 7.5A$	14	-	-	S
Total Gate Charge	Q_g	$I_D = 7.5A$ $V_{DS} = 40V$ $V_{GS} = 4.5V$ See Fig.8	-	4.7	7.0	nC
Pre-Vth Gate-to-Source Charge	Q_{gs1}		-	1.3	-	
Post-Vth Gate-to-Source Charge	Q_{gs2}		-	0.6	-	
Gate-to-Drain Charge	Q_{gd}		-	1.8	-	
Gate Charge Overdrive	Q_{godr}		-	1.0	-	
Switch Charge ($Q_{gs2} + Q_{gd}$)	Q_{sw}		-	2.4	-	
Output Charge	Q_{oss}	$V_{DS} = 40V, V_{GS} = 0V$	-	9.2	-	nC
Turn-On Delay Time	$t_{d(on)}$	$V_{DD} = 40V$	-	7.6	-	ns
Rise Time	t_r	$I_D = 7.5A$	-	22	-	
Turn-Off Delay Time	$t_{d(off)}$	$R_G = 2.7\Omega$	-	9.2	-	
Fall Time	t_f	$V_{GS} = 4.5V$ ③	-	10	-	
Input Capacitance	C_{iss}	$V_{GS} = 0V$	-	540	-	pF
Output Capacitance	C_{oss}	$V_{DS} = 25V$	-	150	-	
Reverse Transfer Capacitance	C_{rss}	$f = 1.0MHz$	-	12	-	
Output Capacitance	C_{oss}	$V_{GS} = 0V, V_{DS} = 1.0V, f = 1.0MHz$	-	410	-	
Output Capacitance	C_{oss}	$V_{GS} = 0V, V_{DS} = 64V, f = 1.0MHz$	-	70	-	

Table 7 Reverse Diode

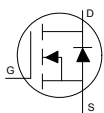
Parameter	Symbol	Conditions	Values			Unit
			Min.	Typ.	Max.	
Continuous Source Current (Body Diode) ⑥ ⑦	I_S	MOSFET symbol showing the integral reverse p-n junction diode. 	-	-	12.5	A
Pulsed Source Current (Body Diode) ①	I_{SM}		-	-	41	
Diode Forward Voltage	V_{SD}	$T_J = 25^\circ C, I_S = 7.5A, V_{GS} = 0V$ ③	-	-	1.2	V
Reverse Recovery Time	t_{rr}	$T_J = 25^\circ C, I_F = 7.5A, V_{DD} = 40V$	-	26	-	ns
Reverse Recovery Charge	Q_{rr}	$di/dt = 100A/\mu s$	-	21	-	nC

4 Electrical characteristic diagrams

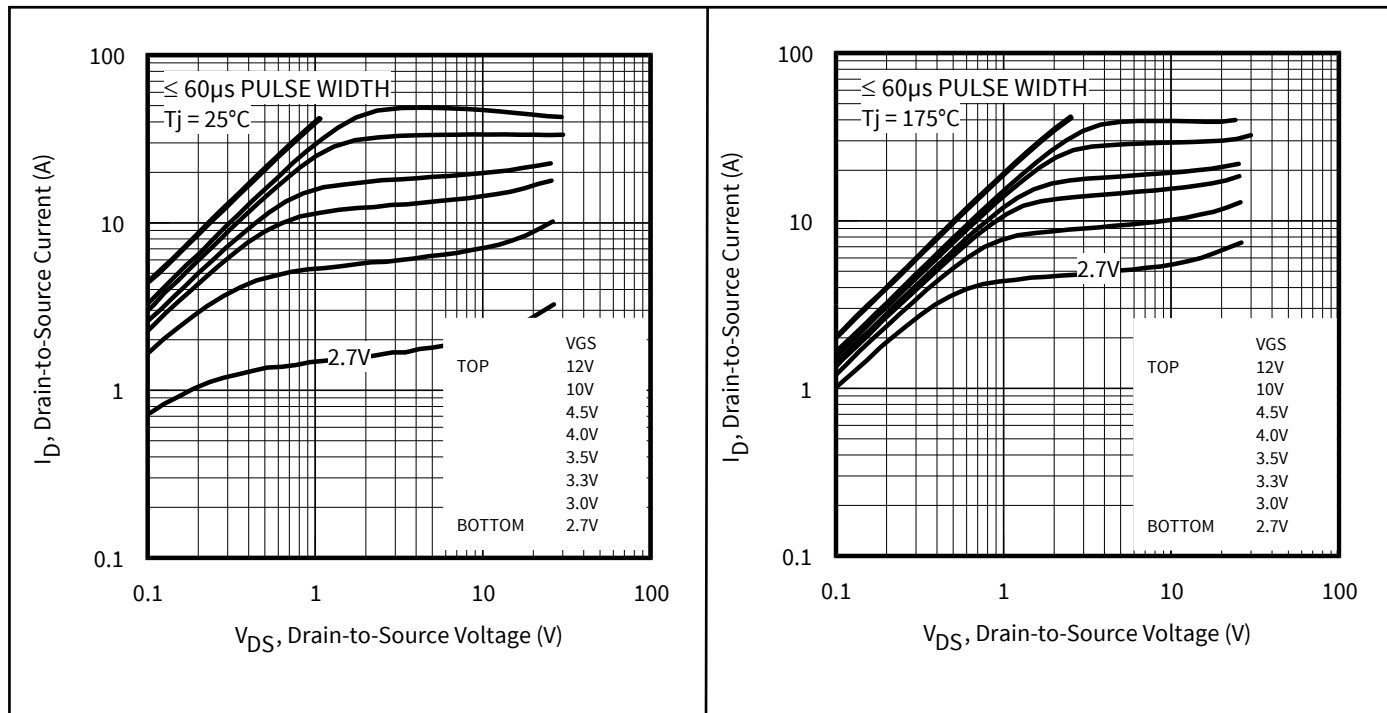

Figure 3 Typical Output Characteristics

Figure 4 Typical Output Characteristics

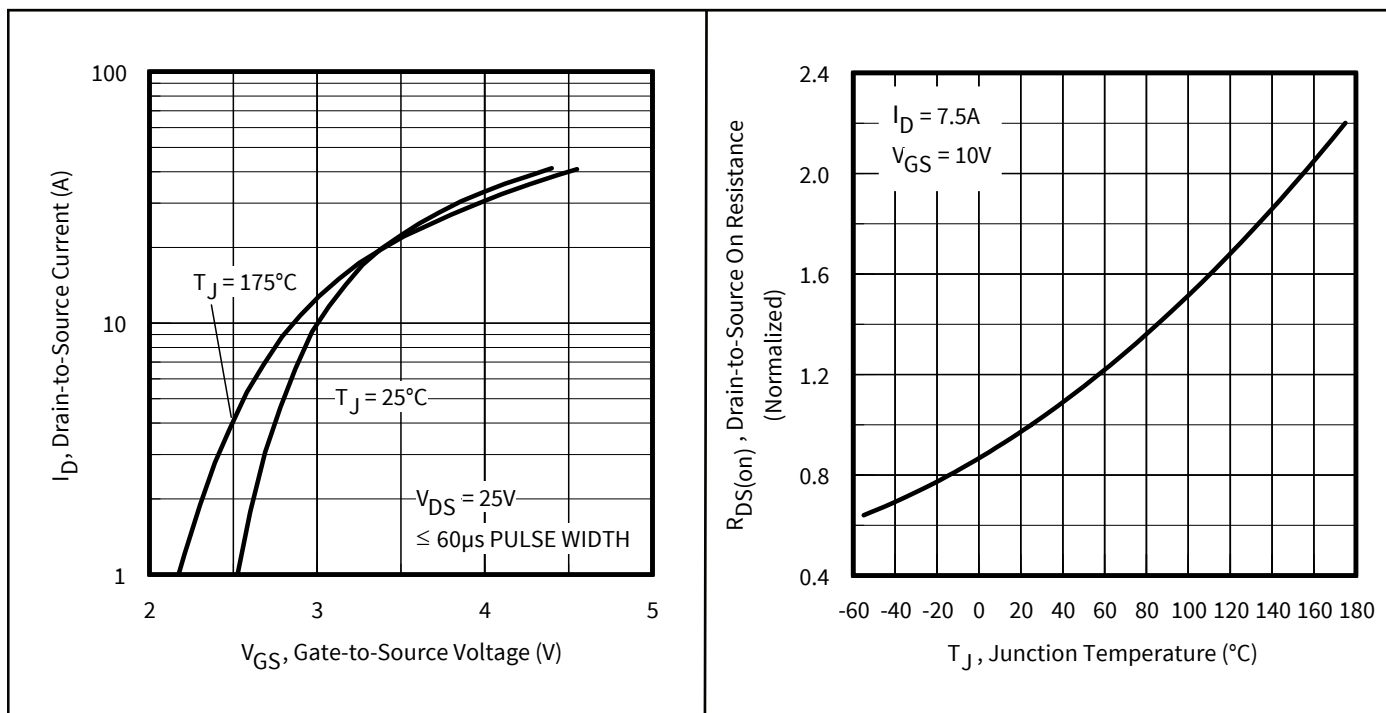

Figure 5 Typical Transfer Characteristics

Figure 6 Normalized On-Resistance vs. Temperature

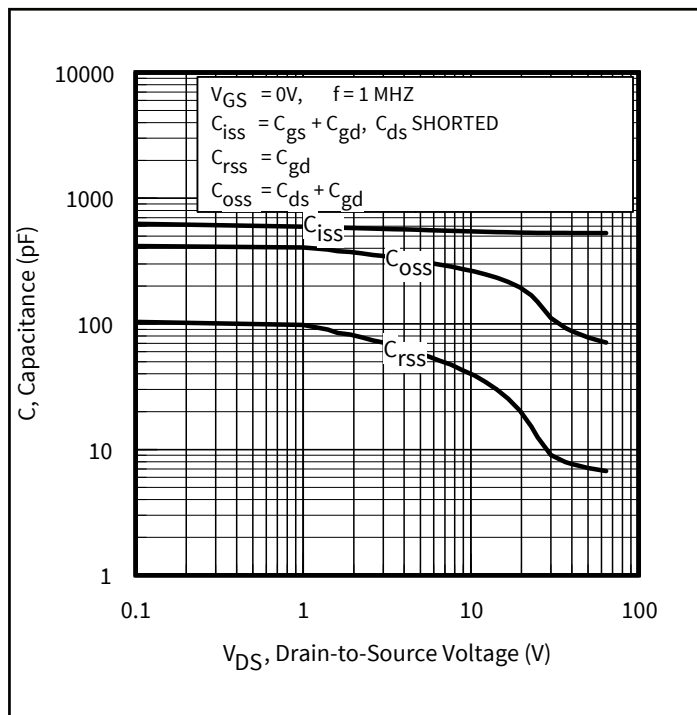

Figure 7 Typical Capacitance vs. Drain-to-Source Voltage

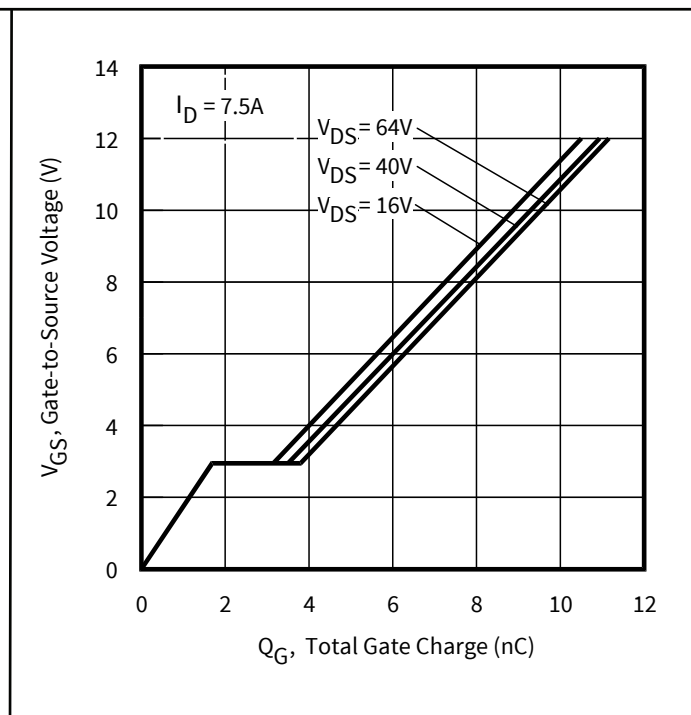

Figure 8 Typical Gate Charge vs. Gate-to-Source Voltage

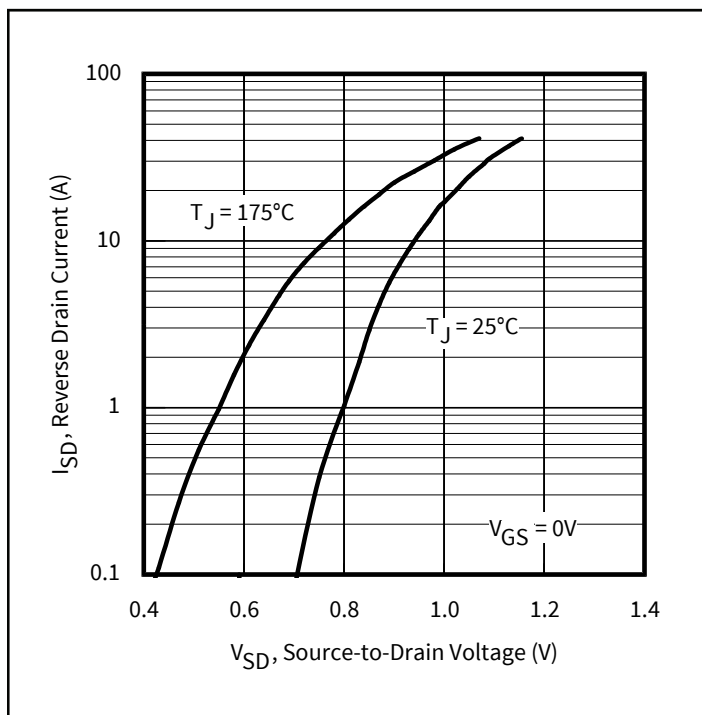

Figure 9 Typical Source-Drain Diode Forward Voltage

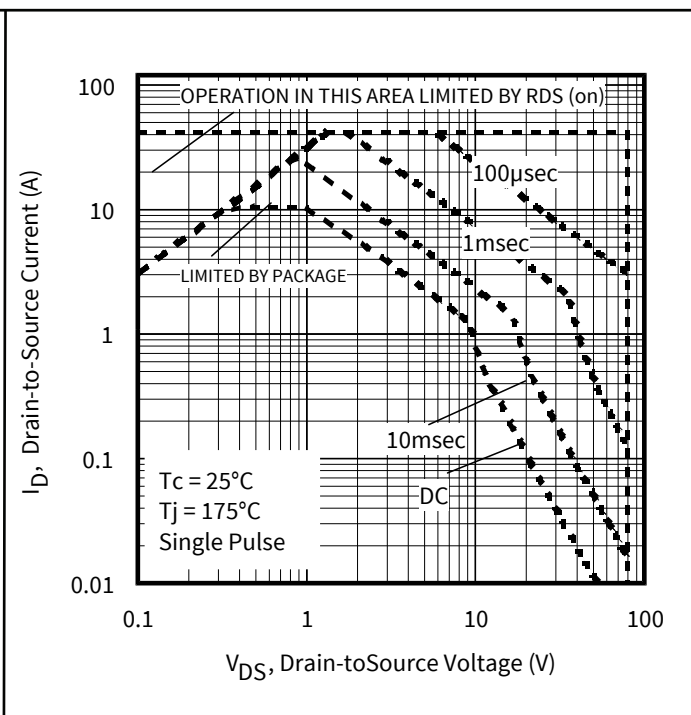

Figure 10 Maximum Safe Operating Area

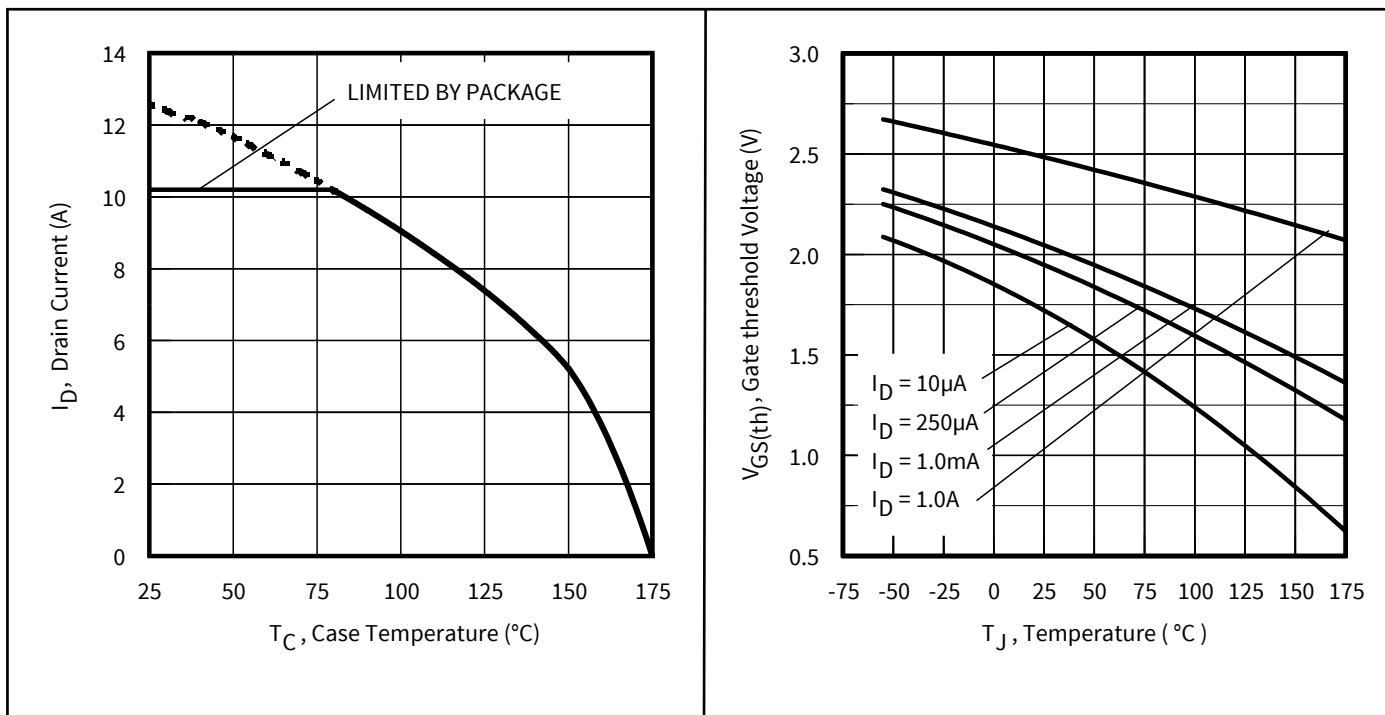

Figure 11 Maximum Drain Current vs. Case Temperature

Figure 12 Typical Threshold Voltage vs. Junction Temperature

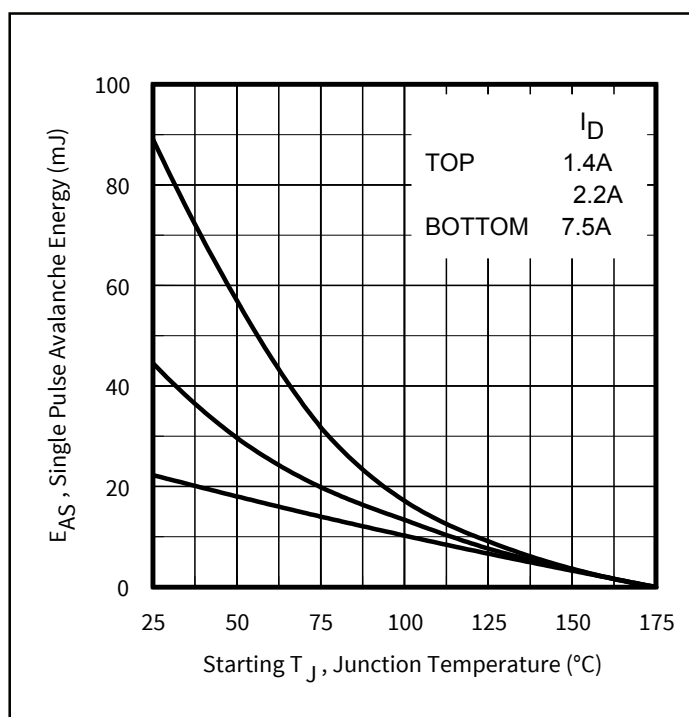

Figure 13 Maximum Avalanche Energy vs. Drain Current

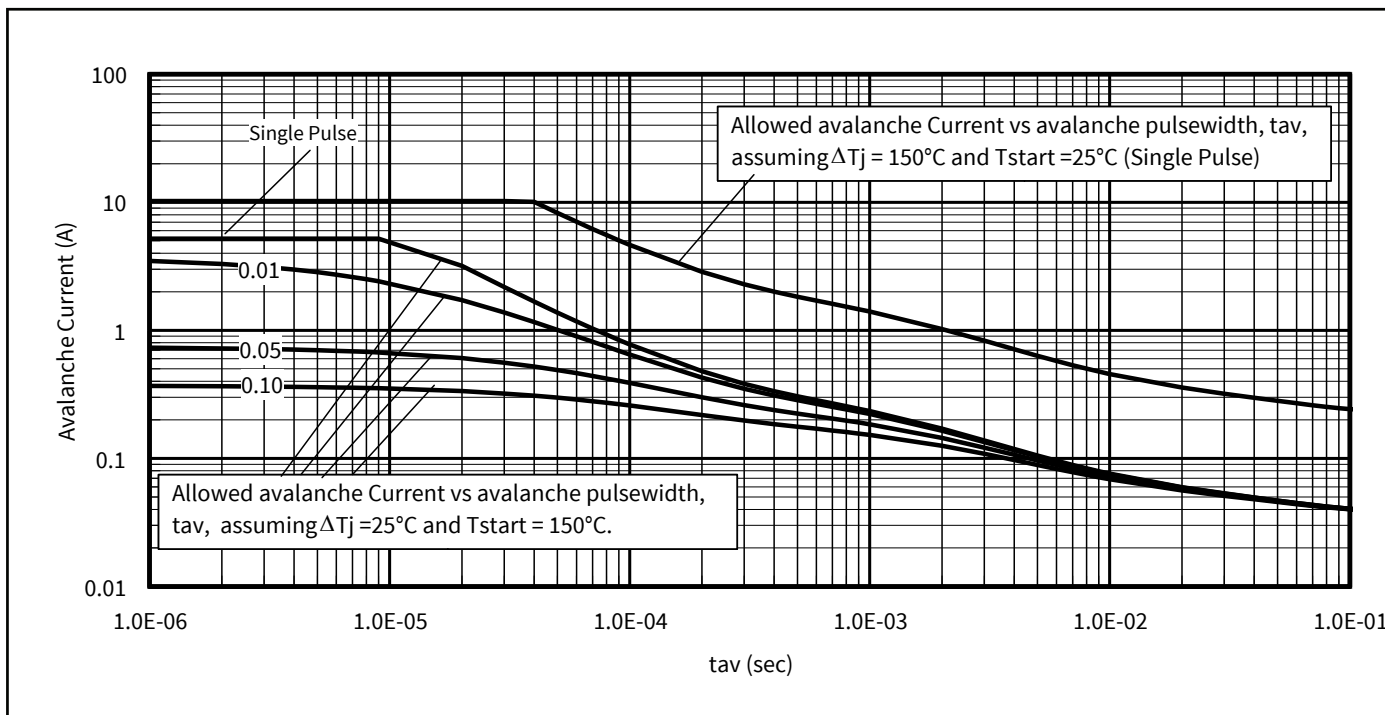

Figure 14 Typical Avalanche Current vs. Pulse Width

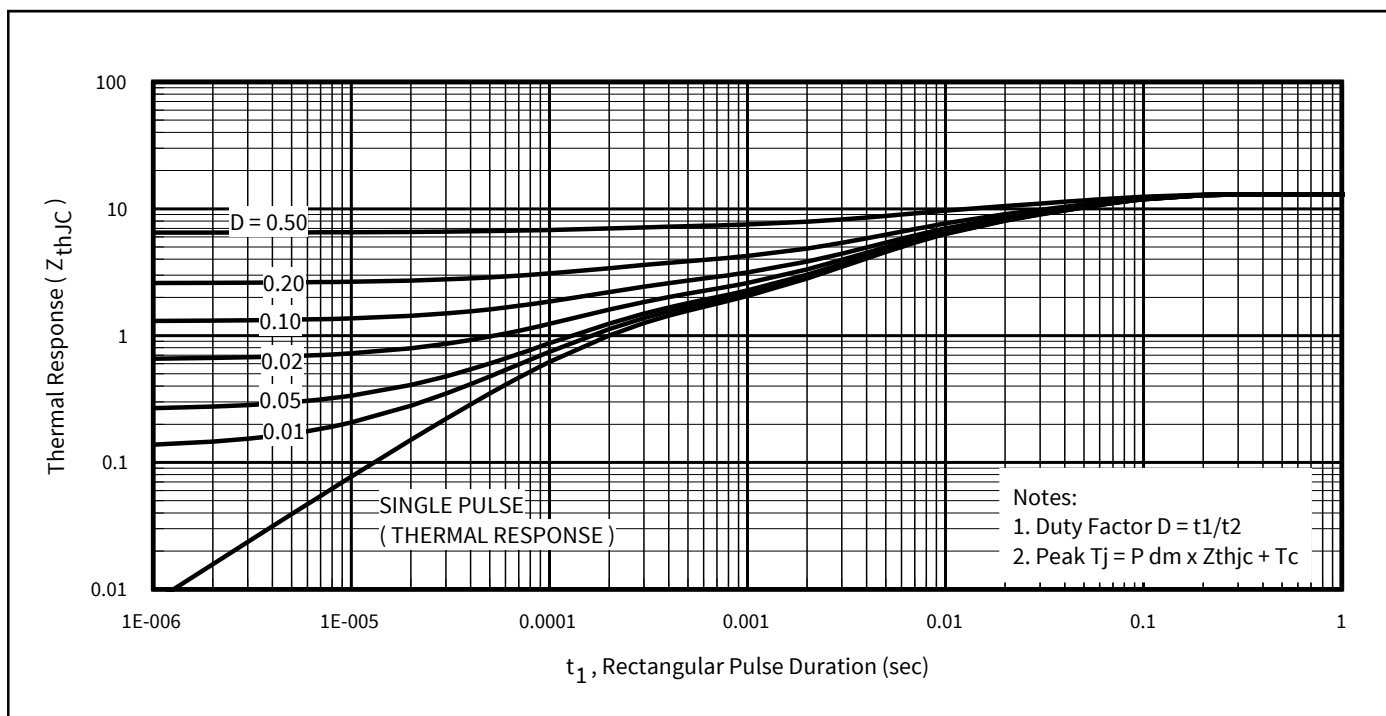

Figure 15 Maximum Effective Transient Thermal Impedance, Junction-to-Case

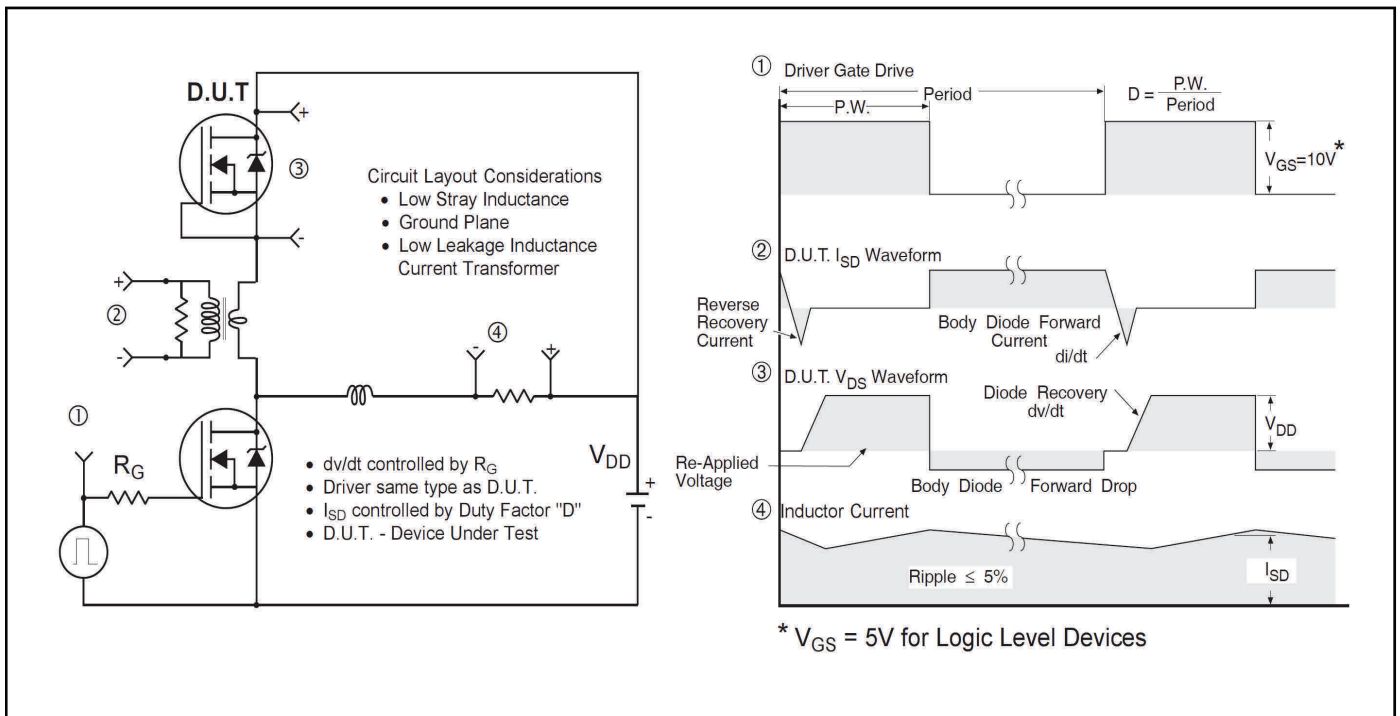

Figure 16 Peak Diode Recovery dv/dt Test Circuit for N-Channel Power MOSFETs

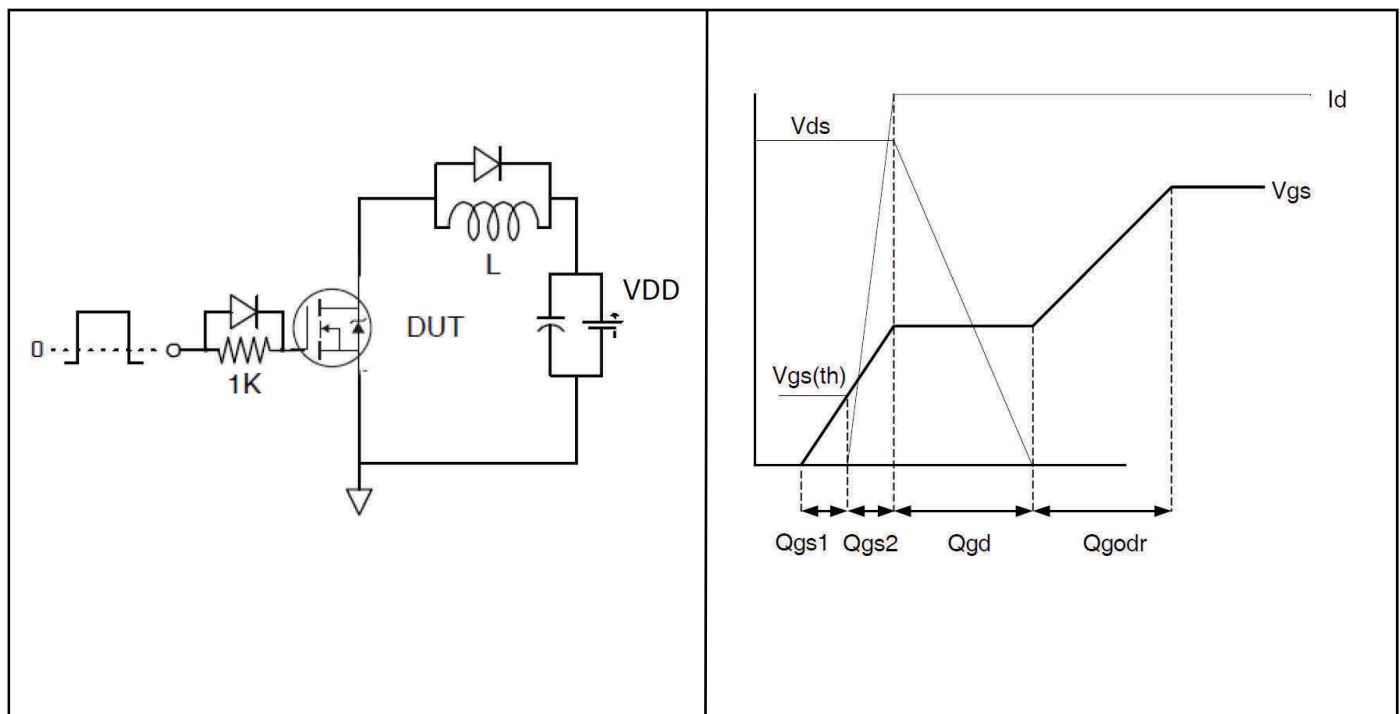

Figure 17a Gate Charge Test Circuit

Figure 17b Gate Charge Waveform

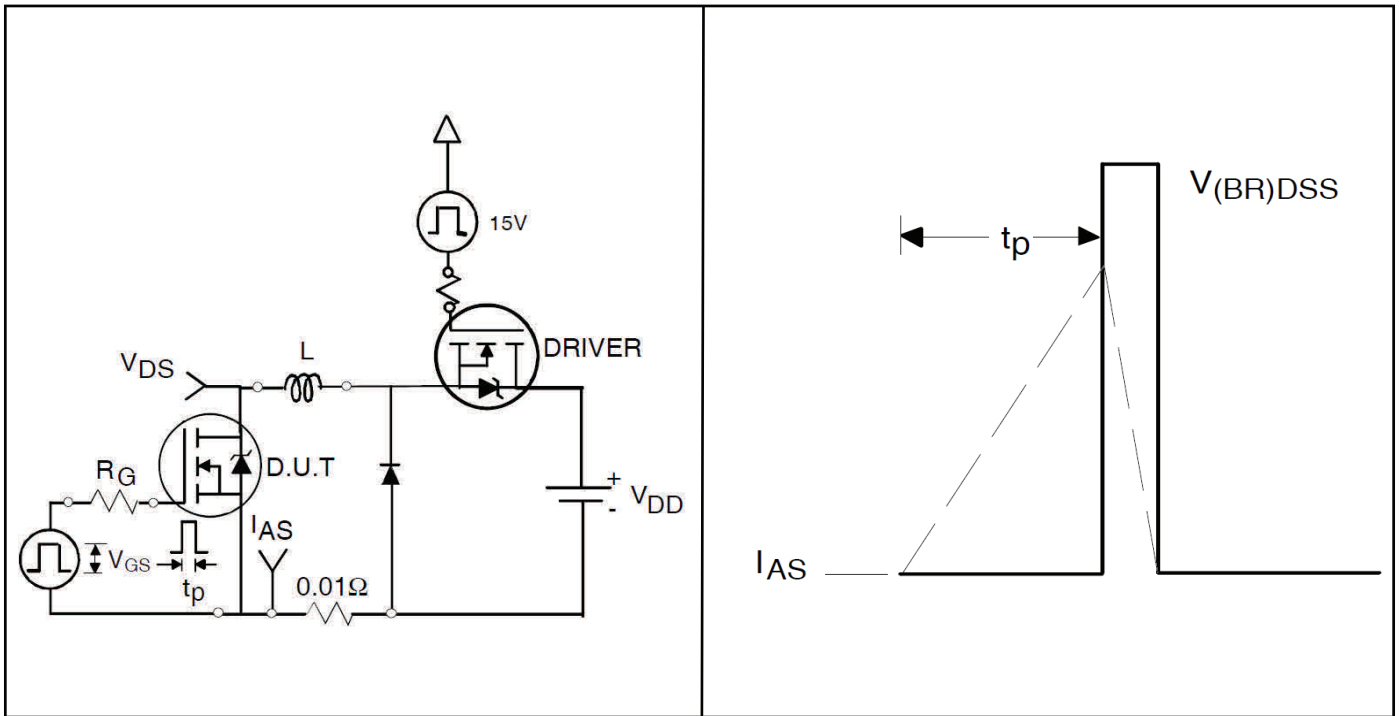

Figure 18a Unclamped Inductive Test Circuit

Figure 18b Unclamped Inductive Waveforms

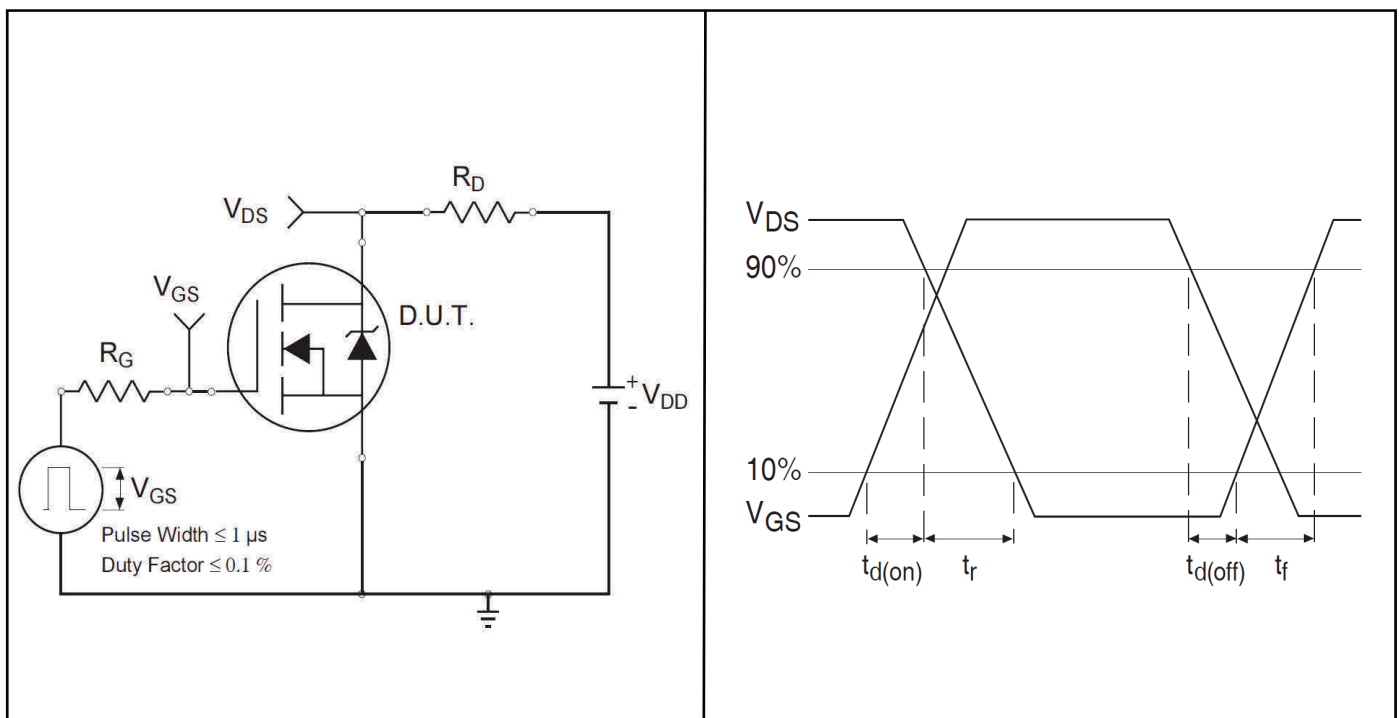
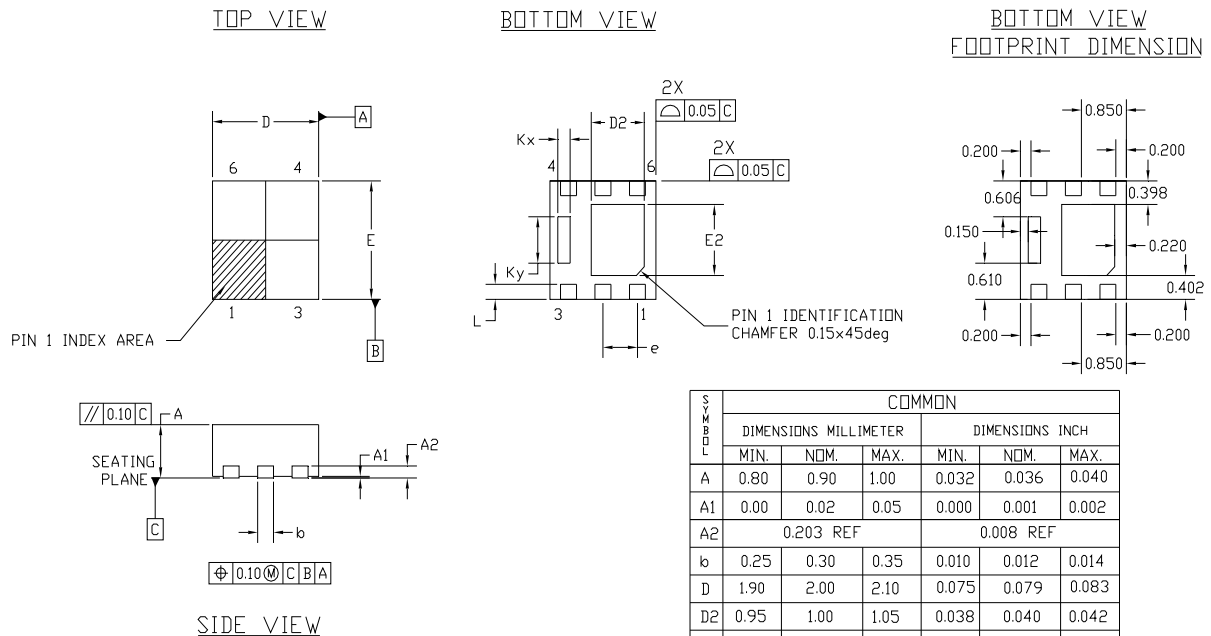

Figure 19a Switching Time Test Circuit

Figure 19b Switching Time Waveforms

5 Package Information

PQFN 2 x 2 Outline Package Details



SYMBOL	COMMON					
	DIMENSIONS MILLIMETER			DIMENSIONS INCH		
	MIN.	NOM.	MAX.	MIN.	NOM.	MAX.
A	0.80	0.90	1.00	0.032	0.036	0.040
A1	0.00	0.02	0.05	0.000	0.001	0.002
A2	0.203 REF			0.008 REF		
b	0.25	0.30	0.35	0.010	0.012	0.014
D	1.90	2.00	2.10	0.075	0.079	0.083
D2	0.95	1.00	1.05	0.038	0.040	0.042
E	1.90	2.00	2.10	0.075	0.079	0.083
E2	1.15	1.20	1.25	0.046	0.048	0.050
e	0.65 BSC			0.026 BSC		
L	0.20	0.25	0.30	0.008	0.010	0.012
Kx	0.23 REF			0.010 REF		
Ky	0.785 REF			0.031 REF		

NOTES :

1. DIMENSION AND TOLERANCING CONFORM TO ASME Y14.5M-1994.
2. CONTROLLING DIMENSIONS : MILLIMETER
3. DIMENSION b APPLIES TO METALLIZED TERMINAL AND IS MEASURED BETWEEN 0.15 AND 0.30 mm. FROM TERMINAL TIP.

For more information on board mounting, including footprint and stencil recommendation, please refer to application note AN-1136: <http://www.infineon.com/technical-info/appnotes/an-1136.pdf>

For more information on package inspection techniques, please refer to application note AN-1154: <http://www.infineon.com/technical-info/appnotes/an-1154.pdf>

PQFN 2 x 2 Part Marking

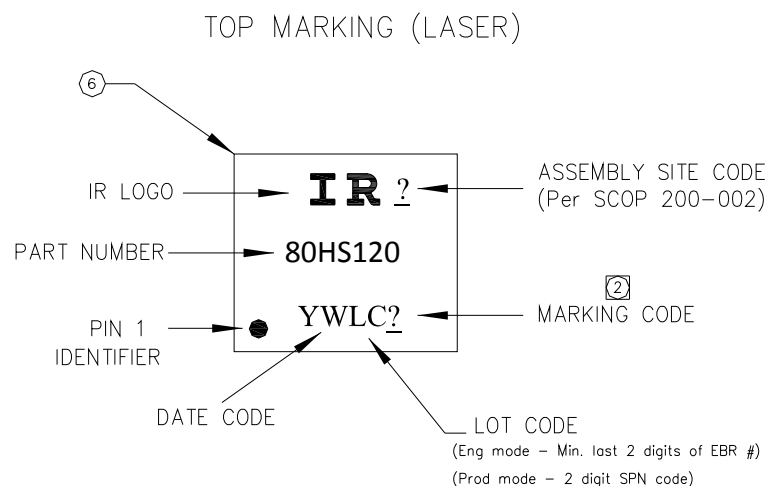

Note: For the most current drawing please refer to website at : www.irf.com/package/

IRL80HS120

Package Information

PQFN 2 x 2 Tape and Reel

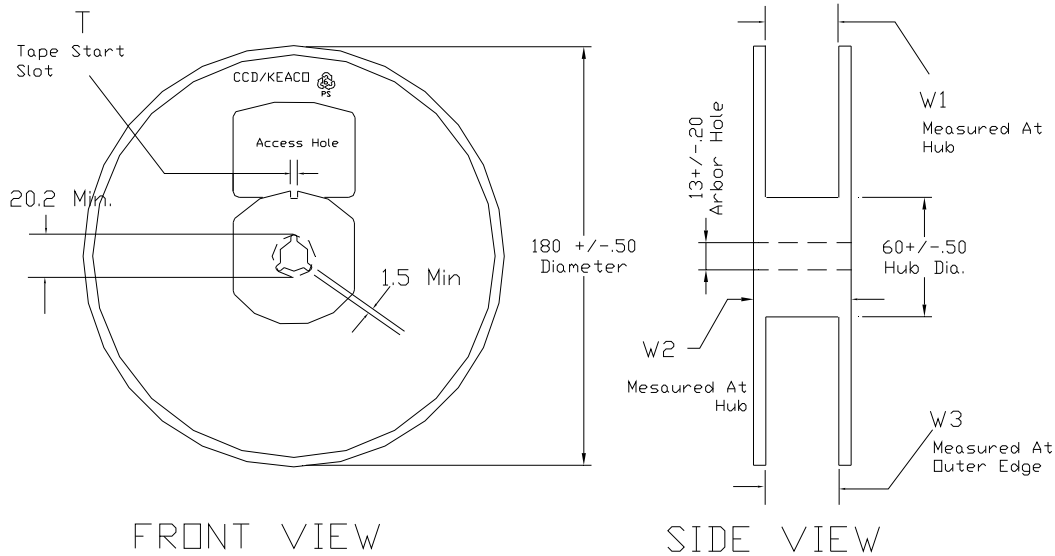
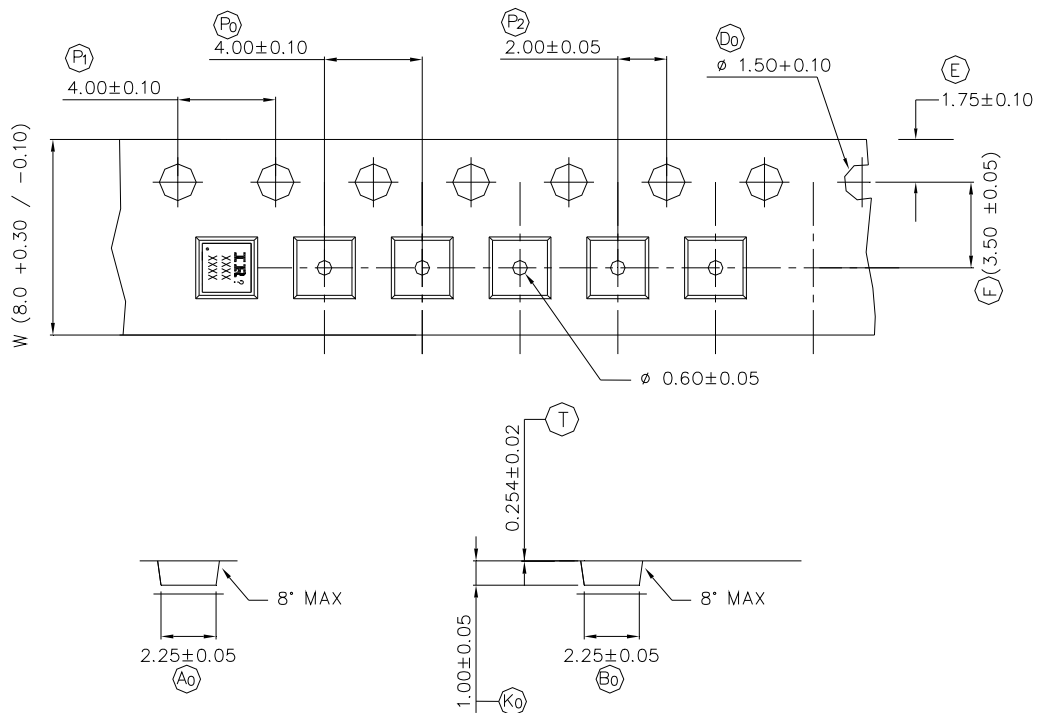

TABLE 1: REEL DETAILS

TAPE WIDTH	T	W1	W2	W3	PART NO
8 MM	3 ± 0.50	8.4 ^{+1.5} _{-0.0}	14.4 Max	7.90 Min 10.9 Max	91586-1
12 MM	5 ± 0.50	12.4 ^{+2.0} _{-0.0}	18.4 Max	11.9 Min 15.4 Max	91586-2

Note: Surface resistivity is $\geq 1 \times 10^5$ but $< 1 \times 10^{12}$ ohm/sq.



NOTE: The Surface Resistivity is $10^4 - 10^8$ OHM/SQ

Note: For the most current drawing please refer to website at : www.irf.com/package/

6 Qualification Information

Qualification Information

Qualification Level	Industrial (per JEDEC JESD47F) †	
Moisture Sensitivity Level	PQFN 2 mm x 2 mm	MSL1 (per JEDEC J-STD-020D)†
RoHS Compliant	Yes	

† Applicable version of JEDEC standard at the time of product release.

Revision History

Major changes since the last revision

Page or Reference	Revision	Date	Description of changes
All pages	1.0	2016-09-21	<ul style="list-style-type: none"> First release data sheet as Provisional.
All pages	1.1	2016-10-17	<ul style="list-style-type: none"> Added Switch Time test data. Datasheet released as Provisional.
All pages	1.2	2017-03-29	<ul style="list-style-type: none"> Parts tested as Unique datasheet with revised current and all other tests Updated datasheet in new Infineon Template Datasheet completed and removed “Approved (Not Released)” from page 1.
All pages	1.3	2017-06-20	<ul style="list-style-type: none"> Table 5— Idss—Corrected typo error for Vds from 48V to 64V—page 5

Trademarks of Infineon Technologies AG

µHVIC™, µIPM™, µPFC™, AU-ConvertIR™, AURIX™, C166™, CanPAK™, CIPOST™, CIPURSE™, CoolDP™, CoolGaN™, COOLiR™, CoolMOS™, CoolSET™, CoolSiC™, DAVE™, DI-POL™, DirectFET™, DrBlade™, EasyPIM™, EconoBRIDGE™, EconoDUAL™, EconoPACK™, EconoPIM™, EiceDRIVER™, eupec™, FCOS™, GaNpowIR™, HEXFET™, HITFET™, HybridPACK™, iMOTION™, IRAM™, ISOFACE™, IsoPACK™, LEDrivIR™, LITIX™, MIPAQ™, ModSTACK™, my-d™, NovalithIC™, OPTIGA™, OptiMOS™, ORIGA™, PowIRaudio™, PowIRstage™, PrimePACK™, PrimeSTACK™, PROFET™, PRO-SIL™, RASIC™, REAL3™, SmartLEWIS™, SOLID FLASH™, SPOC™, StrongIRFET™, SupIRBuck™, TEMPFET™, TRENCHSTOP™, TriCore™, UHVIC™, XHP™, XMC™

Trademarks updated November 2015

Other Trademarks

All referenced product or service names and trademarks are the property of their respective owners.

IMPORTANT NOTICE

Edition 2015-05-06
Published by
Infineon Technologies AG
81726 Munich, Germany

© 2016 Infineon Technologies AG.
All Rights Reserved.

Do you have a question about this document?
Email: erratum@infineon.com

Document reference

The information given in this document shall in no event be regarded as a guarantee of conditions or characteristics ("Beschaffenheitsgarantie").

With respect to any examples, hints or any typical values stated herein and/or any information regarding the application of the product, Infineon Technologies hereby disclaims any and all warranties and liabilities of any kind, including without limitation warranties of non-infringement of intellectual property rights of any third party.

In addition, any information given in this document is subject to customer's compliance with its obligations stated in this document and any applicable legal requirements, norms and standards concerning customer's products and any use of the product of Infineon Technologies in customer's applications.

The data contained in this document is exclusively intended for technically trained staff. It is the responsibility of customer's technical departments to evaluate the suitability of the product for the intended application and the completeness of the product information given in this document with

For further information on the product, technology, delivery terms and conditions and prices please contact your nearest Infineon Technologies office (www.infineon.com).

WARNINGS

Due to technical requirements products may contain dangerous substances. For information on the types in question please contact your nearest Infineon Technologies office.

Except as otherwise explicitly approved by Infineon Technologies in a written document signed by authorized representatives of Infineon Technologies, Infineon Technologies' products may not be used in any applications where a failure of the product or any consequences of the use thereof can reasonably be expected to result in personal injury.